

# Single/Dual Programmable Supply Current, R-R Output, Current Feedback Amplifiers

## FEATURES

- **Programmable Supply Current and Bandwidth:**  
10MHz at 300 $\mu$ A per Amplifier up to 200MHz at 6mA per Amplifier
- **Rail-to-Rail Output:**  
0.05V to 2.85V on 3V Single Supply
- **High Slew Rate:** 700V/ $\mu$ s
- **High Output Drive:**  
 $\pm$ 75mA Minimum Output Current
- **C-Load™ Op Amp Drives All Capacitive Loads**
- **Low Distortion:**  
-70dB HD2 at 1MHz 2V<sub>P-P</sub>  
-75dB HD3 at 1MHz 2V<sub>P-P</sub>
- **Fast Settling:**  
20ns 0.1% Settling for 2V Step
- **Excellent Video Performance Into 150 $\Omega$  Load:**  
Differential Gain of 0.20%, Differential Phase of 0.10°
- **Wide Supply Range:**  
3V to 12V Single Supply  
 $\pm$ 1.5V to  $\pm$ 6V Dual Supplies
- **Small Size:**  
Low Profile (1mm) 6-Lead ThinSOT™,  
3mm  $\times$  3mm  $\times$  0.8mm DFN and 10-Lead MSOP Packages

LT, LT, LTC, LTM, Linear Technology and the Linear logo are registered trademarks and C-Load and ThinSOT are trademarks of Linear Technology Corporation. All other trademarks are the property of their respective owners.

## DESCRIPTION

The LT®6210/LT6211 are single/dual current feedback amplifiers with externally programmable supply current and bandwidth ranging from 10MHz at 300 $\mu$ A per amplifier to 200MHz at 6mA per amplifier. They feature a low distortion rail-to-rail output stage, 700V/ $\mu$ s slew rate and a minimum output current drive of 75mA.

The LT6210/LT6211 operate on supplies as low as a single 3V and up to either 12V or  $\pm$ 6V. The I<sub>SET</sub> pin allows for the optimization of quiescent current for specific bandwidth, distortion or slew rate requirements. Regardless of supply voltage, the supply current is programmable from just 300 $\mu$ A to 6mA per amplifier with an external resistor or current source.

The LT6210 is available in the low profile (1mm) 6-lead TSOT-23 package. The LT6211 is available in the 10-lead MSOP and the 3mm  $\times$  3mm  $\times$  0.8mm DFN packages.

## APPLICATIONS

- Buffers
- Video Amplifiers
- Cable Drivers
- Mobile Communication
- Low Power/Battery Applications

## TYPICAL APPLICATION

Line Driver Configuration for Various Supply Currents

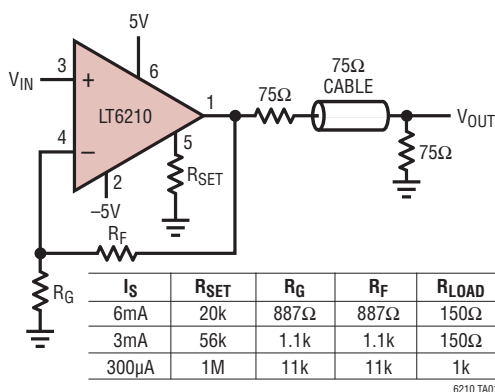

6210 TA01

Small Signal Response vs Supply Current

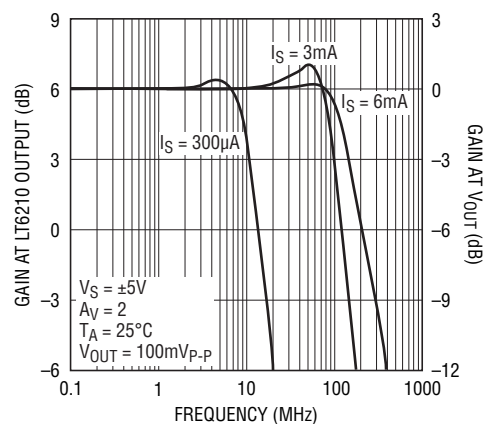

6210 TA01b

# LT6210/LT6211

## ABSOLUTE MAXIMUM RATINGS

(Note 1)

Total Supply Voltage ( $V^+$ to $V^-$ ) .....	13.2V	Junction Temperature (Note 5) .....	150°C
Input Current (Note 8) .....	$\pm 10\text{mA}$	Junction Temperature (DD Package).....	150°C
Output Current.....	$\pm 80\text{mA}$	Storage Temperature Range .....	$-65^\circ\text{C}$ to $150^\circ\text{C}$
Output Short-Circuit Duration (Note 2) .....	Indefinite	Storage Temperature Range (DD Package).....	$-65^\circ\text{C}$ to $150^\circ\text{C}$
Operating Temperature Range (Note 3)....	$-40^\circ\text{C}$ to $85^\circ\text{C}$	Lead Temperature (Soldering, 10 sec) .....	$300^\circ\text{C}$
Specified Temperature Range (Note 4) ....	$-40^\circ\text{C}$ to $85^\circ\text{C}$		

## PIN CONFIGURATION

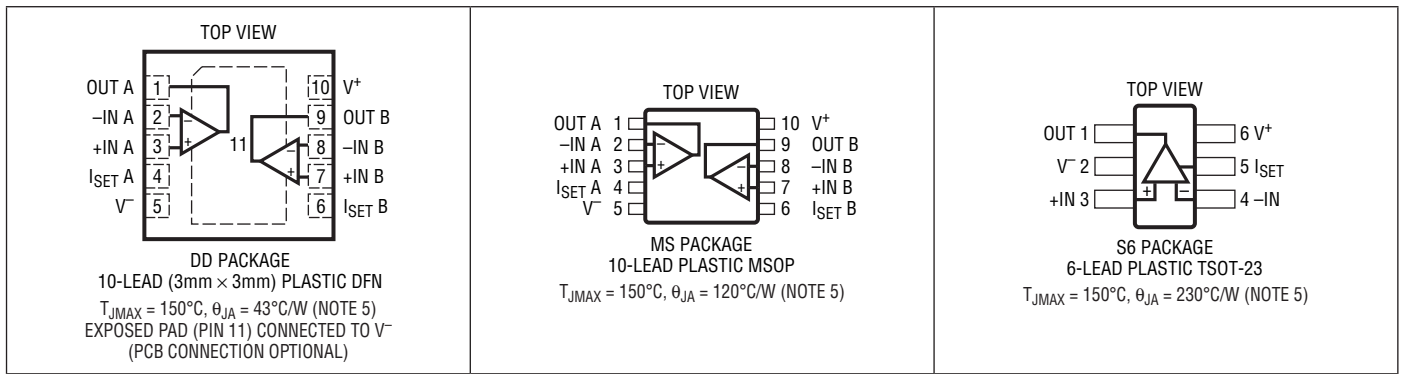

## ORDER INFORMATION

LEAD FREE FINISH	TAPE AND REEL	PART MARKING*	PACKAGE DESCRIPTION	SPECIFIED TEMPERATURE RANGE
LT6211CDD#PBF	LT6211CDD#TRPBF	LBCD	10-Lead (3mm x 3mm) Plastic DFN	$0^\circ\text{C}$ to $70^\circ\text{C}$
LT6211IDD#PBF	LT6211IDD#TRPBF	LBCD	10-Lead (3mm x 3mm) Plastic DFN	$-40^\circ\text{C}$ to $85^\circ\text{C}$
LT6211CMS#PBF	LT6211CMS#TRPBF	LTBBN	10-Lead Plastic MSOP	$0^\circ\text{C}$ to $70^\circ\text{C}$
LT6211IMS#PBF	LT6211IMS#TRPBF	LTBBP	10-Lead Plastic MSOP	$-40^\circ\text{C}$ to $85^\circ\text{C}$
LT6210CS6#PBF	LT6210CS6#TRPBF	LTA3	6-Lead Plastic TSOT-23	$0^\circ\text{C}$ to $70^\circ\text{C}$
LT6210IS6#PBF	LT6210IS6#TRPBF	LTA3	6-Lead Plastic TSOT-23	$-40^\circ\text{C}$ to $85^\circ\text{C}$
LEAD BASED FINISH	TAPE AND REEL	PART MARKING*	PACKAGE DESCRIPTION	SPECIFIED TEMPERATURE RANGE
LT6211CDD	LT6211CDD#TR	LBCD	10-Lead (3mm x 3mm) Plastic DFN	$0^\circ\text{C}$ to $70^\circ\text{C}$
LT6211IDD	LT6211IDD#TR	LBCD	10-Lead (3mm x 3mm) Plastic DFN	$-40^\circ\text{C}$ to $85^\circ\text{C}$
LT6211CMS	LT6211CMS#TR	LTBBN	10-Lead Plastic MSOP	$0^\circ\text{C}$ to $70^\circ\text{C}$
LT6211IMS	LT6211IMS#TR	LTBBP	10-Lead Plastic MSOP	$-40^\circ\text{C}$ to $85^\circ\text{C}$
LT6210CS6	LT6210CS6#TR	LTA3	6-Lead Plastic TSOT-23	$0^\circ\text{C}$ to $70^\circ\text{C}$
LT6210IS6	LT6210IS6#TR	LTA3	6-Lead Plastic TSOT-23	$-40^\circ\text{C}$ to $85^\circ\text{C}$

Consult LTC Marketing for parts specified with wider operating temperature ranges. \*The temperature grade is identified by a label on the shipping container.

For more information on lead free part marking, go to: <http://www.linear.com/leadfree/>

For more information on tape and reel specifications, go to: <http://www.linear.com/tapeandreeel/>

**ELECTRICAL CHARACTERISTICS** ( $I_S = 6\text{mA}$  per Amplifier) The ● denotes the specifications which apply over the specified operating temperature range, otherwise specifications are at  $T_A = 25^\circ\text{C}$ . For  $V^+ = 5\text{V}$ ,  $V^- = -5\text{V}$ :  $R_{SET} = 20\text{k}$  to ground,  $A_V = +2$ ,  $R_F = R_G = 887\Omega$ ,  $R_L = 150\Omega$ ; For  $V^+ = 3\text{V}$ ,  $V^- = 0\text{V}$ :  $R_{SET} = 0\Omega$  to  $V^-$ ,  $A_V = +2$ ,  $R_F = 887\Omega$ ,  $R_G = 887\Omega$  to  $1.5\text{V}$ ,  $R_L = 150\Omega$  to  $1.5\text{V}$  unless otherwise specified.

SYMBOL	PARAMETER	CONDITIONS	$V^+ = 5\text{V}$ , $V^- = -5\text{V}$ , $I_S = 6\text{mA}$			$V^+ = 3\text{V}$ , $V^- = 0\text{V}$ , $I_S = 6\text{mA}$			UNITS
			MIN	TYP	MAX	MIN	TYP	MAX	
$V_{OS}$	Input Offset Voltage			-1	$\pm 6$		-1	$\pm 6.5$	mV
			●		$\pm 9$		$\pm 10$	mV	
$I_{IN}^+$	Noninverting Input Current			-3.5	$\pm 7$		-3	$\pm 6.5$	$\mu\text{A}$
			●		$\pm 9$		$\pm 8$	$\mu\text{A}$	
$I_{IN}^-$	Inverting Input Current			-13.5	$\pm 39$		2.5	$\pm 25$	$\mu\text{A}$
			●		$\pm 55$		$\pm 40$	$\mu\text{A}$	
$e_n$	Input Noise Voltage Density	$f = 1\text{kHz}$ , $R_F = 887\Omega$ , $R_G = 46.4\Omega$ , $R_S = 0\Omega$		6.5			6.5		$\text{nV}/\sqrt{\text{Hz}}$
$+i_n$	Input Noise Current Density	$f = 1\text{kHz}$		4.5			4.5		$\text{pA}/\sqrt{\text{Hz}}$
$-i_n$	Input Noise Current Density	$f = 1\text{kHz}$		25			25		$\text{pA}/\sqrt{\text{Hz}}$
$R_{IN}^+$	Noninverting Input Resistance	$V_{IN} = V^+ - 1.2\text{V}$ to $V^- + 1.2\text{V}$	●	0.5	2		0.3	1.7	$\text{M}\Omega$
$C_{IN}^+$	Noninverting Input Capacitance	$f = 100\text{kHz}$		2			2		pF
$V_{INH}$	Input Voltage Range, High	(Note 10)	●	3.8	4.2		1.8	2.2	V
$V_{INL}$	Input Voltage Range, Low	(Note 10)	●	-4.2	-3.8		0.8	1.2	V
$V_{OUTH}$	Output Voltage Swing, High	$R_L = 1\text{k}$ (Note 11) $R_L = 150\Omega$ (Note 11) $R_L = 150\Omega$ (Note 11)			4.8			2.85	V
			●	4.4	4.6		2.65	2.75	V
				4.2			2.6		V
$V_{OUTL}$	Output Voltage Swing, Low	$R_L = 1\text{k}$ (Note 11) $R_L = 150\Omega$ (Note 11) $R_L = 150\Omega$ (Note 11)		-4.95			0.05		V
			●		-4.8	-4.55	0.1	0.3	V
					-4.4		0.35		V
CMRR	Common Mode Rejection Ratio	$V_{IN} = V^+ - 1.2\text{V}$ to $V^- + 1.2\text{V}$		46	50		46		dB
			●	43					dB
$-I_{CMRR}$	Inverting Input Current Common Mode Rejection	$V_{IN} = V^+ - 1.2\text{V}$ to $V^- + 1.2\text{V}$	●		0.15	$\pm 1.5$	0.2		$\mu\text{A}/\text{V}$
			●		$\pm 2$				$\mu\text{A}/\text{V}$
PSRR	Power Supply Rejection Ratio	$V_S = \pm 1.5\text{V}$ to $\pm 6\text{V}$ (Note 6)	●	60	85		60	85	dB
$-I_{PSRR}$	Inverting Input Current Power Supply Rejection	$V_S = \pm 1.5\text{V}$ to $\pm 6\text{V}$ (Note 6)		2	$\pm 7$		2	$\pm 7$	$\mu\text{A}/\text{V}$
			●		$\pm 8$		$\pm 8$	$\mu\text{A}/\text{V}$	
$I_S$	Supply Current per Amplifier			6	8.5		5.8	8.3	mA
			●		10		9	mA	

# LT6210/LT6211

**ELECTRICAL CHARACTERISTICS** ( $I_S = 6\text{mA}$  per Amplifier) The ● denotes the specifications which apply over the specified operating temperature range, otherwise specifications are at  $T_A = 25^\circ\text{C}$ . For  $V^+ = 5\text{V}$ ,  $V^- = -5\text{V}$ :  $R_{SET} = 20\text{k}$  to ground,  $A_V = +2$ ,  $R_F = R_G = 887\Omega$ ,  $R_L = 150\Omega$ ; For  $V^+ = 3\text{V}$ ,  $V^- = 0\text{V}$ :  $R_{SET} = 0\Omega$  to  $V^-$ ,  $A_V = +2$ ,  $R_F = 887\Omega$ ,  $R_G = 887\Omega$  to  $1.5\text{V}$ ,  $R_L = 150\Omega$  to  $1.5\text{V}$  unless otherwise specified.

SYMBOL	PARAMETER	CONDITIONS	$V^+ = 5\text{V}$ , $V^- = -5\text{V}$ , $I_S = 6\text{mA}$			$V^+ = 3\text{V}$ , $V^- = 0\text{V}$ , $I_S = 6\text{mA}$			UNITS
			MIN	TYP	MAX	MIN	TYP	MAX	
$I_{OUT}$	Maximum Output Current	$R_L = 0\Omega$ (Notes 7, 11)	●	±75			±45		mA
$R_{OL}$	Transimpedance, $\Delta V_{OUT}/\Delta I_{IN}^-$	$V_{OUT} = V^+ - 1.2\text{V}$ to $V^- + 1.2\text{V}$		65	115		65	115	k $\Omega$
SR	Slew Rate	(Note 8)		500	700		200		V/ $\mu\text{s}$
$t_{pd}$	Propagation Delay	50% $V_{IN}$ to 50% $V_{OUT}$ , 100mV <sub>P-P</sub> , Larger of $t_{pd}^+$ , $t_{pd}^-$			1.5			2.4	ns
BW	-3dB Bandwidth	<1dB Peaking, $A_V = 1$			200			120	MHz
$t_s$	Settling Time	To 0.1% of $V_{FINAL}$ , $V_{STEP} = 2\text{V}$			20			25	ns
$t_f$ , $t_r$	Small-Signal Rise and Fall Time	10% to 90%, $V_{OUT} = 100\text{mV}_{P-P}$			2			3.5	ns
dG	Differential Gain	(Note 9)			0.20			0.35	%
dP	Differential Phase	(Note 9)			0.10			0.20	Deg
HD2	2nd Harmonic Distortion	$f = 1\text{MHz}$ , $V_{OUT} = 2\text{V}_{P-P}$			-70			-65	dBc
HD3	3rd Harmonic Distortion	$f = 1\text{MHz}$ , $V_{OUT} = 2\text{V}_{P-P}$			-75			-75	dBc

( $I_S = 3\text{mA}$  per Amplifier) The ● denotes the specifications which apply over the specified operating temperature range, otherwise specifications are at  $T_A = 25^\circ\text{C}$ . For  $V^+ = 5\text{V}$ ,  $V^- = -5\text{V}$ :  $R_{SET} = 56\text{k}$  to ground,  $A_V = +2$ ,  $R_F = R_G = 1.1\text{k}$ ,  $R_L = 150\Omega$ ; For  $V^+ = 3\text{V}$ ,  $V^- = 0\text{V}$ :  $R_{SET} = 10\text{k}$  to  $V^-$ ,  $A_V = +2$ ,  $R_F = 1.27\text{k}$ ,  $R_G = 1.27\text{k}$  to  $1.5\text{V}$ ,  $R_L = 150\Omega$  to  $1.5\text{V}$  unless otherwise specified.

SYMBOL	PARAMETER	CONDITIONS	$V^+ = 5\text{V}$ , $V^- = -5\text{V}$ , $I_S = 3\text{mA}$			$V^+ = 3\text{V}$ , $V^- = 0\text{V}$ , $I_S = 3\text{mA}$			UNITS	
			MIN	TYP	MAX	MIN	TYP	MAX		
$V_{OS}$	Input Offset Voltage		●	-1	±5.5 ±8.5		-1.5	±5.5 ±8.5	mV mV	
$I_{IN}^+$	Noninverting Input Current		●	-1.5	±5 ±7		-1.5	±5 ±7	$\mu\text{A}$ $\mu\text{A}$	
$I_{IN}^-$	Inverting Input Current		●	-12	±36 ±52		-3	±15 ±20	$\mu\text{A}$ $\mu\text{A}$	
en	Input Noise Voltage Density	$f = 1\text{kHz}$ , $R_F = 1.1\text{k}$ , $R_G = 57.6\Omega$ , $R_S = 0\Omega$			7			7	nV/ $\sqrt{\text{Hz}}$	
$+i_n$	Input Noise Current Density	$f = 1\text{kHz}$			1.5			1.5	pA/ $\sqrt{\text{Hz}}$	
$-i_n$	Input Noise Current Density	$f = 1\text{kHz}$			15			15	pA/ $\sqrt{\text{Hz}}$	
$R_{IN}^+$	Noninverting Input Resistance	$V_{IN} = V^+ - 1.2\text{V}$ to $V^- + 1.2\text{V}$	●	0.5	3		1	2.5	M $\Omega$	
$C_{IN}^+$	Noninverting Input Capacitance	$f = 100\text{kHz}$			2			2	pF	
$V_{INH}$	Input Voltage Range, High	(Note 10)	●	3.8	4.1		1.8	2.1	V	
$V_{INL}$	Input Voltage Range, Low	(Note 10)	●		-4.1	-3.8		0.9	1.2	V
$V_{OUTH}$	Output Voltage Swing, High	$R_L = 1\text{k}$ (Note 11) $R_L = 150\Omega$ (Note 11) $R_L = 150\Omega$ (Note 11)	●	4.3	4.8 4.6		2.6	2.9 2.8	V V V	
$V_{OUTL}$	Output Voltage Swing, Low	$R_L = 1\text{k}$ (Note 11) $R_L = 150\Omega$ (Note 11) $R_L = 150\Omega$ (Note 11)	●		-4.95 -4.8	-4.55 -4.4		0.05 0.1	0.3 0.35	V V V
CMRR	Common Mode Rejection Ratio	$V_{IN} = V^+ - 1.2\text{V}$ to $V^- + 1.2\text{V}$	●	46 43	50		46		dB dB	
$-I_{CMRR}$	Inverting Input Current Common Mode Rejection	$V_{IN} = V^+ - 1.2\text{V}$ to $V^- + 1.2\text{V}$	●		0.3	±1.5 ±2		0.4	$\mu\text{A/V}$ $\mu\text{A/V}$	

62101fc

**ELECTRICAL CHARACTERISTICS** ( $I_S = 3\text{mA}$  per Amplifier) The ● denotes the specifications which apply over the specified operating temperature range, otherwise specifications are at  $T_A = 25^\circ\text{C}$ . For  $V^+ = 5\text{V}$ ,  $V^- = -5\text{V}$ :  $R_{SET} = 56\text{k}$  to ground,  $A_V = +2$ ,  $R_F = R_G = 1.1\text{k}$ ,  $R_L = 150\Omega$ ; For  $V^+ = 3\text{V}$ ,  $V^- = 0\text{V}$ :  $R_{SET} = 10\text{k}$  to  $V^-$ ,  $A_V = +2$ ,  $R_F = 1.27\text{k}$ ,  $R_G = 1.27\text{k}$  to  $1.5\text{V}$ ,  $R_L = 150\Omega$  to  $1.5\text{V}$  unless otherwise specified.

SYMBOL	PARAMETER	CONDITIONS	$V^+ = 5\text{V}$ , $V^- = -5\text{V}$ , $I_S = 3\text{mA}$			$V^+ = 3\text{V}$ , $V^- = 0\text{V}$ , $I_S = 3\text{mA}$			UNITS	
			MIN	TYP	MAX	MIN	TYP	MAX		
PSRR	Power Supply Rejection Ratio	$V_S = \pm 1.5\text{V}$ to $\pm 6\text{V}$ (Note 6)	●	60	85		60	85	dB	
$-I_{PSRR}$	Inverting Input Current Power Supply Rejection	$V_S = \pm 1.5\text{V}$ to $\pm 6\text{V}$ (Note 6)	●		1.5	$\pm 7$ $\pm 8$		1.5	$\pm 7$ $\pm 8$	$\mu\text{A/V}$ $\mu\text{A/V}$
$I_S$	Supply Current per Amplifier		●		3	4.1 4.55		3	4.1 4.4	mA mA
$I_{OUT}$	Maximum Output Current	$R_L = 0\Omega$ (Notes 7, 11)	●	$\pm 70$			$\pm 45$			mA
$R_{OL}$	Transimpedance, $\Delta V_{OUT}/\Delta I_{IN^-}$	$V_{OUT} = V^+ - 1.2\text{V}$ to $V^- + 1.2\text{V}$		65	120		65	120		$\text{k}\Omega$
SR	Slew Rate	(Note 8)		450	600		150			$\text{V}/\mu\text{s}$
$t_{pd}$	Propagation Delay	50% $V_{IN}$ to 50% $V_{OUT}$ , 100mV <sub>P-P</sub> , Larger of $t_{pd^+}$ , $t_{pd^-}$			3.1			4.7		ns
BW	-3dB Bandwidth	<1dB Peaking, $A_V = 1$			100			70		MHz
$t_s$	Settling Time	To 0.1% of $V_{FINAL}$ , $V_{STEP} = 2\text{V}$			20			25		ns
$t_f$ , $t_r$	Small-Signal Rise and Fall Time	10% to 90%, $V_{OUT} = 100\text{mV}_{P-P}$			3			5.6		ns
dG	Differential Gain	(Note 9)			0.35			0.42		%
dP	Differential Phase	(Note 9)			0.30			0.44		Deg
HD2	2nd Harmonic Distortion	$f = 1\text{MHz}$ , $V_{OUT} = 2\text{V}_{P-P}$			-65			-60		dBc
HD3	3rd Harmonic Distortion	$f = 1\text{MHz}$ , $V_{OUT} = 2\text{V}_{P-P}$			-65			-65		dBc

**( $I_S = 300\mu\text{A}$  per Amplifier)** The ● denotes the specifications which apply over the specified operating temperature range, otherwise specifications are at  $T_A = 25^\circ\text{C}$ . For  $V^+ = 5\text{V}$ ,  $V^- = -5\text{V}$ :  $R_{SET} = 1\text{M}$  to ground,  $A_V = +2$ ,  $R_F = R_G = 11\text{k}$ ,  $R_L = 1\text{k}$ ; For  $V^+ = 3\text{V}$ ,  $V^- = 0\text{V}$ :  $R_{SET} = 270\text{k}$  to  $V^-$ ,  $A_V = +2$ ,  $R_F = 9.31\text{k}$ ,  $R_G = 9.31\text{k}$  to  $1.5\text{V}$ ,  $R_L = 1\text{k}$  to  $1.5\text{V}$  unless otherwise specified.

SYMBOL	PARAMETER	CONDITIONS	$V^+ = 5\text{V}$ , $V^- = -5\text{V}$ , $I_S = 300\mu\text{A}$			$V^+ = 3\text{V}$ , $V^- = 0\text{V}$ , $I_S = 300\mu\text{A}$			UNITS	
			MIN	TYP	MAX	MIN	TYP	MAX		
$V_{OS}$	Input Offset Voltage		●	-1	$\pm 4.5$ $\pm 8$		-1.5	$\pm 4.5$ $\pm 8$	mV mV	
$I_{IN^+}$	Noninverting Input Current		●	0.2	$\pm 1$ $\pm 2$		0.2	$\pm 1$ $\pm 1.5$	$\mu\text{A}$ $\mu\text{A}$	
$I_{IN^-}$	Inverting Input Current		●	-3	$\pm 8.5$ $\pm 11$		-0.5	$\pm 3$ $\pm 4.5$	$\mu\text{A}$ $\mu\text{A}$	
en	Input Noise Voltage Density	$f = 1\text{kHz}$ , $R_F = 13\text{k}$ , $R_G = 681\Omega$ , $R_S = 0\Omega$			13.5			13.5		$\text{nV}/\sqrt{\text{Hz}}$
$+i_n$	Input Noise Current Density	$f = 1\text{kHz}$			0.75			0.75		$\text{pA}/\sqrt{\text{Hz}}$
$-i_n$	Input Noise Current Density	$f = 1\text{kHz}$			5			5		$\text{pA}/\sqrt{\text{Hz}}$
$R_{IN^+}$	Noninverting Input Resistance	$V_{IN} = V^+ - 1.2\text{V}$ to $V^- + 1.2\text{V}$ (Note 8)	●	1	25		1	15		$\text{M}\Omega$
$C_{IN^+}$	Noninverting Input Capacitance	$f = 100\text{kHz}$			2			2		pF
$V_{INH}$	Input Voltage Range, High	(Note 10)	●	3.8	4.1		1.8	2.1		V
$V_{INL}$	Input Voltage Range, Low	(Note 10)	●		-4.1	-3.8		0.9	1.2	V
$V_{OUTH}$	Output Voltage Swing, High	$R_L = 1\text{k}$ (Note 11)	●	4.75 4.7	4.85		2.75 2.7	2.85		V V
$V_{OUTL}$	Output Voltage Swing, Low	$R_L = 1\text{k}$ (Note 11)	●		-4.95	-4.85 -4.8		0.05	0.15 0.2	V V

## ELECTRICAL CHARACTERISTICS $(I_S = 300\mu\text{A per Amplifier})$ The ● denotes the specifications which apply over the specified operating temperature range, otherwise specifications are at $T_A = 25^\circ\text{C}$ . For $V^+ = 5\text{V}$ , $V^- = -5\text{V}$ : $R_{SET} = 1\text{M}$ to ground, $A_V = +2$ , $R_F = R_G = 11\text{k}$ , $R_L = 1\text{k}$ ; For $V^+ = 3\text{V}$ , $V^- = 0\text{V}$ : $R_{SET} = 270\text{k}$ to $V^-$ , $A_V = +2$ , $R_F = 9.31\text{k}$ , $R_G = 9.31\text{k}$ to $1.5\text{V}$ , $R_L = 1\text{k}$ to $1.5\text{V}$ unless otherwise specified.

SYMBOL	PARAMETER	CONDITIONS	$V^+ = 5\text{V}$ , $V^- = -5\text{V}$ , $I_S = 300\mu\text{A}$			$V^+ = 3\text{V}$ , $V^- = 0\text{V}$ , $I_S = 300\mu\text{A}$			UNITS
			MIN	TYP	MAX	MIN	TYP	MAX	
CMRR	Common Mode Rejection Ratio	$V_{IN} = V^+ - 1.2\text{V}$ to $V^- + 1.2\text{V}$	● 46 43	50			46		dB dB
$-I_{CMRR}$	Inverting Input Current Common Mode Rejection	$V_{IN} = V^+ - 1.2\text{V}$ to $V^- + 1.2\text{V}$	●	0.15	$\pm 1.5$ $\pm 2$		0.2		$\mu\text{A/V}$ $\mu\text{A/V}$
PSRR	Power Supply Rejection Ratio	$V_S = \pm 1.5\text{V}$ to $\pm 6\text{V}$ (Note 6)	●	60	85		60	85	dB
$-I_{PSRR}$	Inverting Input Current Power Supply Rejection	$V_S = \pm 1.5\text{V}$ to $\pm 6\text{V}$ (Note 6)	●		0.4 $\pm 2.2$ $\pm 4$		0.4	$\pm 2.2$ $\pm 4$	$\mu\text{A/V}$ $\mu\text{A/V}$
$I_S$	Supply Current per Amplifier		●		0.3 0.525 0.6		0.3	0.38 0.43	mA mA
$I_{OUT}$	Maximum Output Current	$R_L = 0\Omega$ (Notes 7, 11)	●	$\pm 30$			$\pm 10$		mA
$R_{OL}$	Transimpedance, $\Delta V_{OUT}/\Delta I_{IN}^-$	$V_{OUT} = V^+ - 1.2\text{V}$ to $V^- + 1.2\text{V}$		300	660		65	120	k $\Omega$
SR	Slew Rate	(Note 8)		120	170		20		V/ $\mu\text{s}$
$t_{pd}$	Propagation Delay	50% $V_{IN}$ to 50% $V_{OUT}$ , 100mV <sub>P-P</sub> , Larger of $t_{pd}^+$ , $t_{pd}^-$			30		50		ns
BW	-3dB Bandwidth	<1dB Peaking, $A_V = 1$			10		7.5		MHz
$t_s$	Settling Time	To 0.1% of $V_{FINAL}$ , $V_{STEP} = 2\text{V}$			200		300		ns
$t_r$ , $t_f$	Small-Signal Rise and Fall Time	10% to 90%, $V_{OUT} = 100\text{mV}_{P-P}$			40		50		ns
HD2	2nd Harmonic Distortion	$f = 1\text{MHz}$ , $V_{OUT} = 2\text{V}_{P-P}$			-40		-45		dBc
HD3	3rd Harmonic Distortion	$f = 1\text{MHz}$ , $V_{OUT} = 2\text{V}_{P-P}$			-45		-45		dBc

**Note 1:** Stresses beyond those listed under Absolute Maximum Ratings may cause permanent damage to the device. Exposure to any Absolute Maximum Rating condition for extended periods may affect device reliability and lifetime.

**Note 2:** As long as output current and junction temperature are kept below the absolute maximum ratings, no damage to the part will occur. Depending on the supply voltage, a heat sink may be required.

**Note 3:** The LT6210/LT6211C is guaranteed functional over the operating temperature range of  $-40^\circ\text{C}$  to  $85^\circ\text{C}$ .

**Note 4:** The LT6210/LT6211C is guaranteed to meet specified performance from  $0^\circ\text{C}$  to  $70^\circ\text{C}$ . The LT6210C/LT6211C is designed, characterized and expected to meet specified performance from  $-40^\circ\text{C}$  and  $85^\circ\text{C}$  but is not tested or QA sampled at these temperatures. The LT6210I/LT6211I is guaranteed to meet specified performance from  $-40^\circ\text{C}$  to  $85^\circ\text{C}$ .

**Note 5:** The LT6210 with no metal connected to the  $V^-$  pin has a  $\theta_{JA}$  of  $230^\circ\text{C/W}$ , however, thermal resistances vary depending upon the amount of PC board metal attached to Pin 2 of the device. With the LT6210 mounted on a  $2500\text{mm}^2$  3/32" FR-4 board covered with 2oz copper on both sides and with just  $20\text{mm}^2$  of copper attached to Pin 2,  $\theta_{JA}$  drops to  $160^\circ\text{C/W}$ . Thermal performance can be improved even further by using a 4-layer board or by attaching more metal area to Pin 2.

Thermal resistance of the LT6211 in MSOP-10 is specified for a  $2500\text{mm}^2$  3/32" FR-4 board covered with 2oz copper on both sides and with  $100\text{mm}^2$  of copper attached to Pin 5. Its performance can also be increased with additional copper much like the LT6210.

To achieve the specified  $\theta_{JA}$  of  $43^\circ\text{C/W}$  for the LT6211 DFN-10, the exposed pad must be soldered to the PCB. In this package,  $\theta_{JA}$  will benefit

from increased copper area attached to the exposed pad.

$T_J$  is calculated from the ambient temperature  $T_A$  and the power dissipation PD according to the following formula:

$$T_J = T_A + (P_D \cdot \theta_{JA})$$

The maximum power dissipation can be calculated by:

$$P_{D(MAX)} = (V_S \cdot I_{S(MAX)}) + (V_S/2)^2/R_{LOAD}$$

**Note 6:** For PSRR and  $-I_{PSRR}$  testing, the current into the  $I_{SET}$  pin is constant, maintaining a consistent LT6210/LT6211 quiescent bias point. A graph of PSRR vs Frequency is included in the Typical Performance Characteristics showing +PSRR and  $-PSRR$  with  $R_{SET}$  connecting  $I_{SET}$  to ground.

**Note 7:** While the LT6210 and LT6211 circuitry is capable of significant output current even beyond the levels specified, sustained short-circuit current exceeding the Absolute Maximum Rating of  $\pm 80\text{mA}$  may permanently damage the device.

**Note 8:** This parameter is guaranteed to meet specified performance through design and characterization. It is not production tested.

**Note 9:** Differential gain and phase are measured using a Tektronix TSG120YC/NTSC signal generator and a Tektronix 1780R Video Measurement Set. The resolution of this equipment is 0.1% and  $0.1^\circ$ . Five identical amplifier stages were cascaded giving an effective resolution of 0.02% and  $0.02^\circ$ .

**Note 10:** Input voltage range on  $\pm 5\text{V}$  dual supplies is guaranteed by CMRR. On 3V single supply it is guaranteed by design and by correlation to the  $\pm 5\text{V}$  input voltage range limits.

**Note 11:** This parameter is tested by forcing a 50mV differential voltage between the inverting and noninverting inputs.

## TYPICAL AC PERFORMANCE

$V_S$ (V)	$I_S$ (mA) per Amplifier	$R_{SET}$ ( $\Omega$ )	$A_V$	$R_L$ ( $\Omega$ )	$R_F$ ( $\Omega$ )	$R_G$ ( $\Omega$ )	SMALL-SIGNAL -3dB BW, <1dB PEAKING (MHz)	SMALL-SIGNAL $\pm 0.1$ dB BW (MHz)
$\pm 5$	6	20k	1	150	1200	—	200	30
$\pm 5$	6	20k	2	150	887	887	160	30
$\pm 5$	6	20k	-1	150	698	698	140	20
$\pm 5$	3	56k	1	150	1690	—	100	15
$\pm 5$	3	56k	2	150	1100	1100	100	15
$\pm 5$	3	56k	-1	150	1200	1200	80	15
$\pm 5$	0.3	1M	1	1k	13.7k	—	10	2
$\pm 5$	0.3	1M	2	1k	11k	11k	10	2
$\pm 5$	0.3	1M	-1	1k	10k	10k	10	1.8
3, 0	6	0	1	150	1100	—	120	20
3, 0	6	0	2	150	887	887	100	20
3, 0	6	0	-1	150	806	806	100	20
3, 0	3	10k	1	150	1540	—	70	15
3, 0	3	10k	2	150	1270	1270	60	15
3, 0	3	10k	-1	150	1200	1200	60	15
3, 0	0.3	270k	1	1k	13k	—	7.5	2
3, 0	0.3	270k	2	1k	9.31k	9.31k	7	1.5
3, 0	0.3	270k	-1	1k	10k	10k	7	1.5

## TYPICAL PERFORMANCE CHARACTERISTICS

Supply Current per Amplifier vs Temperature

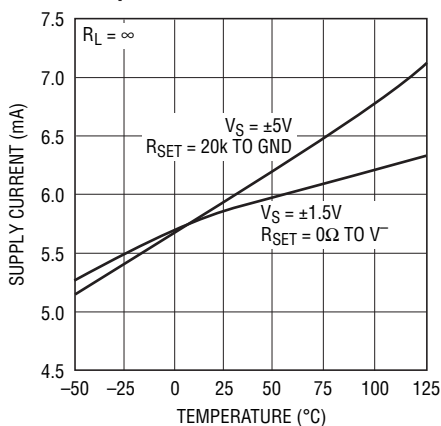

6210 G01

Supply Current per Amplifier vs Temperature

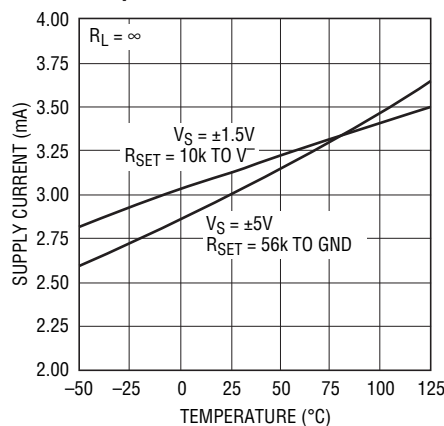

6210 G02

Supply Current per Amplifier vs Temperature

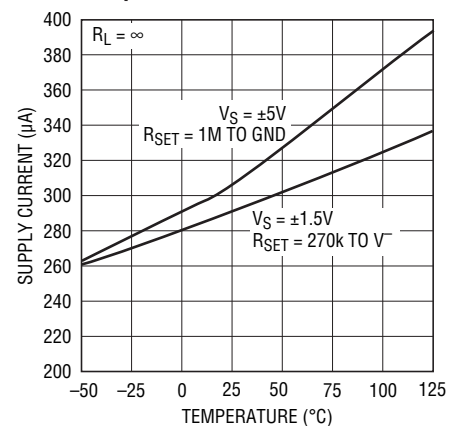

6210 G03



## TYPICAL PERFORMANCE CHARACTERISTICS (Supply Current $I_S$ Measured Per Amplifier)

**Input Noise Spectral Density**  
( $I_S = 6\text{mA}$  per Amplifier)

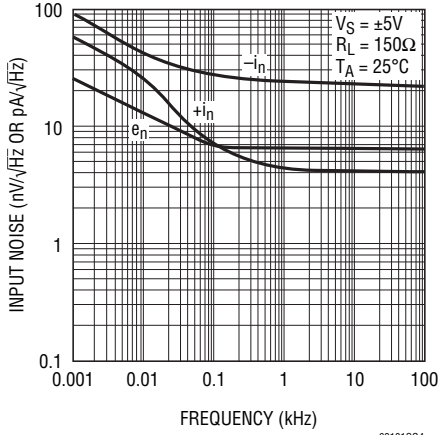

**Input Noise Spectral Density**  
( $I_S = 3\text{mA}$  per Amplifier)

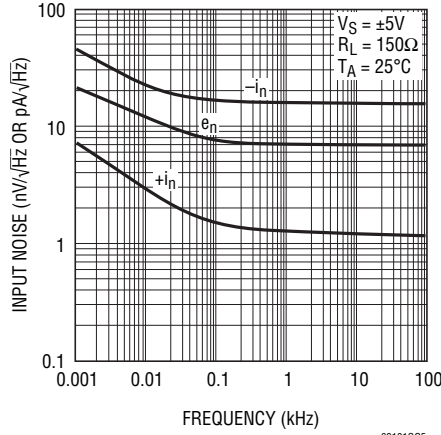

**Input Noise Spectral Density**  
( $I_S = 300\mu\text{A}$  per Amplifier)

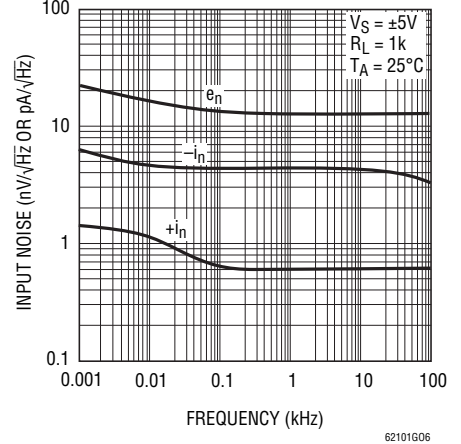

**Input Offset Voltage vs Input Common Mode Voltage**

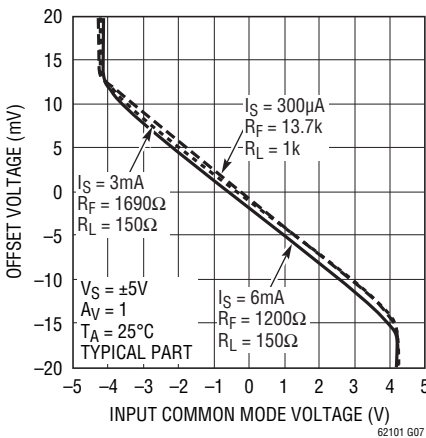

**Input Common Mode Range vs Temperature**

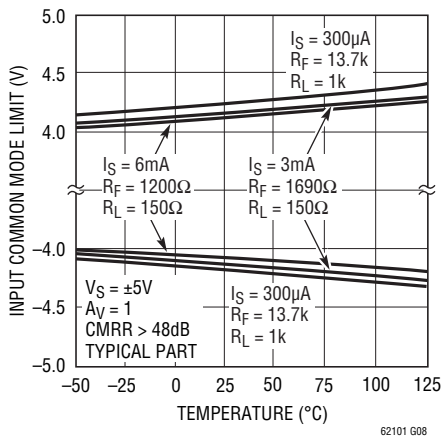

**Input Common Mode Range vs Temperature**

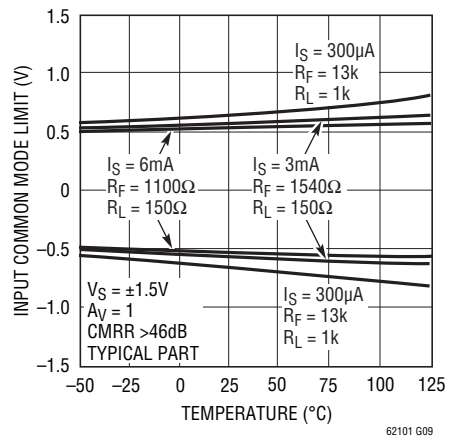

**Output Voltage Swing vs Temperature**

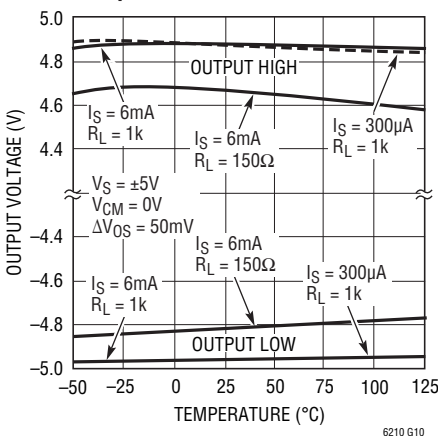

**Output Voltage Swing vs Temperature**

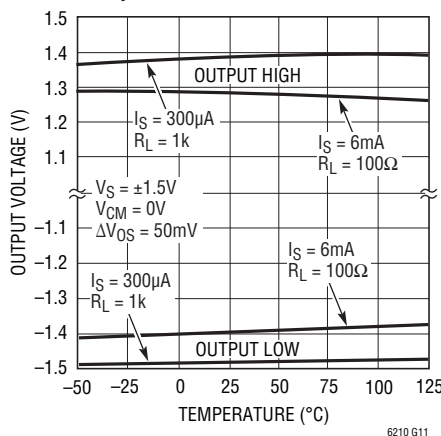

**Output Voltage Swing vs  $I_{LOAD}$**

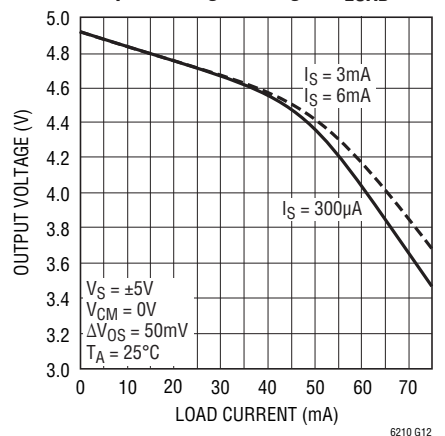



**TYPICAL PERFORMANCE CHARACTERISTICS** (Supply Current  $I_S$  Measured Per Amplifier)

**Output Voltage Swing vs  $I_{LOAD}$**

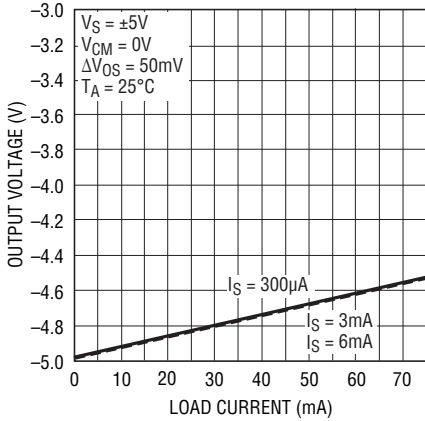

6210 G13

**Output Voltage Swing vs  $I_{LOAD}$**

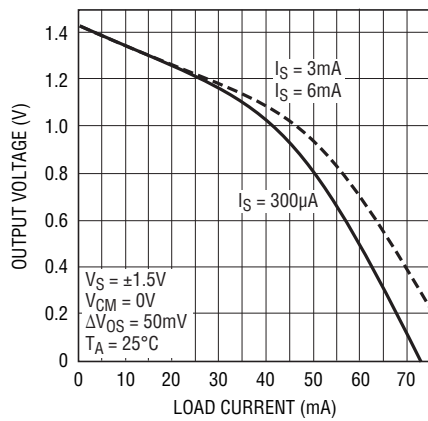

6210 G14

**Output Voltage Swing vs  $I_{LOAD}$**

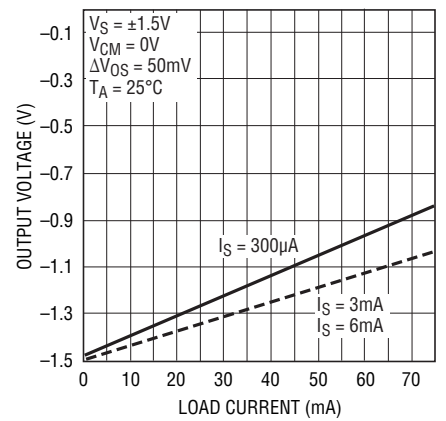

6210 G15

**CMRR and PSRR vs Frequency ( $I_S = 6mA$  per Amplifier)**

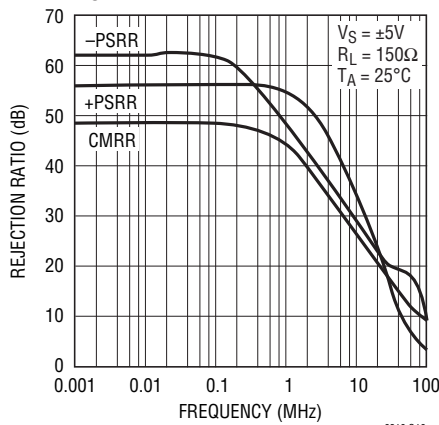

6210 G16

**CMRR and PSRR vs Frequency ( $I_S = 3mA$  per Amplifier)**

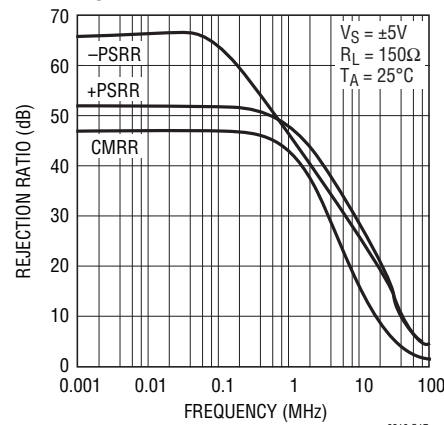

6210 G17

**CMRR and PSRR vs Frequency ( $I_S = 300µA$  per Amplifier)**

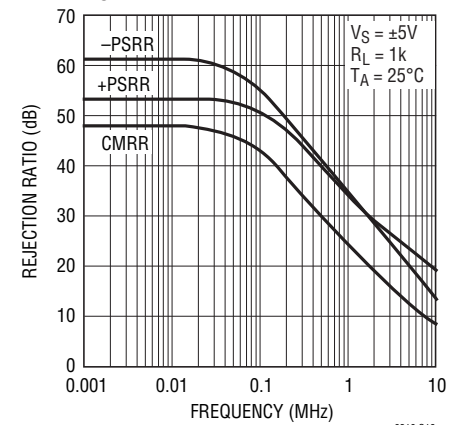

6210 G18

**Frequency Response vs Closed Loop Gain ( $I_S = 6mA$  per Amplifier)**

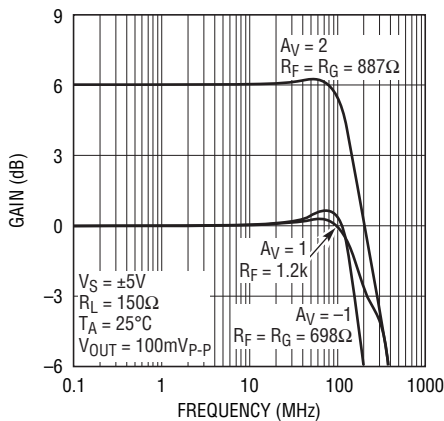

6210 G19

**Frequency Response vs Closed Loop Gain ( $I_S = 3mA$  per Amplifier)**

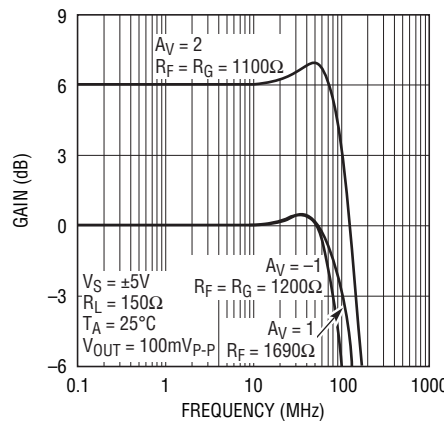

6210 G20

**Frequency Response vs Closed Loop Gain ( $I_S = 300µA$  per Amplifier)**

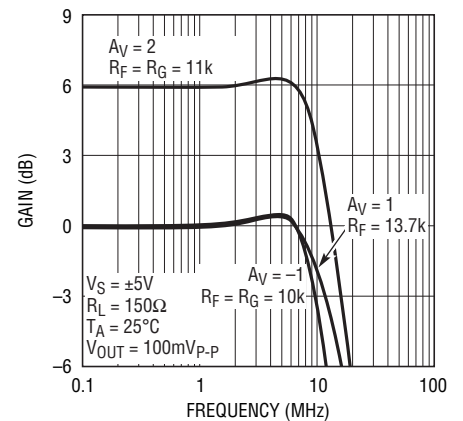

6210 G21

**TYPICAL PERFORMANCE CHARACTERISTICS** (Supply Current Is Measured Per Amplifier)

**2nd and 3rd Harmonic Distortion vs Frequency ( $I_S = 6\text{mA}$  per Amplifier)**



6210 G22

**2nd and 3rd Harmonic Distortion vs Frequency ( $I_S = 3\text{mA}$  per Amplifier)**



6210 G23

**2nd and 3rd Harmonic Distortion vs Frequency ( $I_S = 300\mu\text{A}$  per Amplifier)**

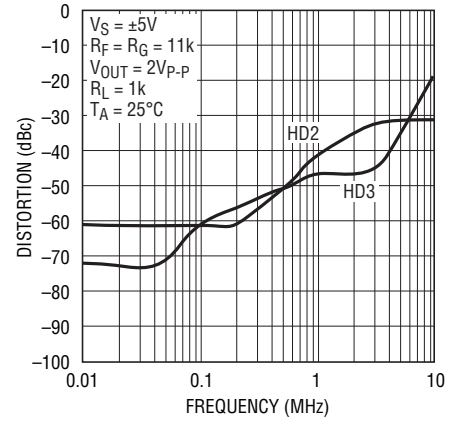

6210 G24

**Maximum Undistorted Output Sinusoid vs Frequency**



6210 G25

**Output Impedance vs Frequency**



6210 G26

**LT6211 Channel Separation vs Frequency**

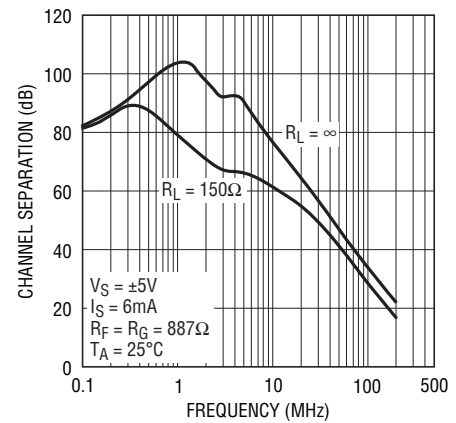

6210 G27

**Overshoot vs Capacitive Load**

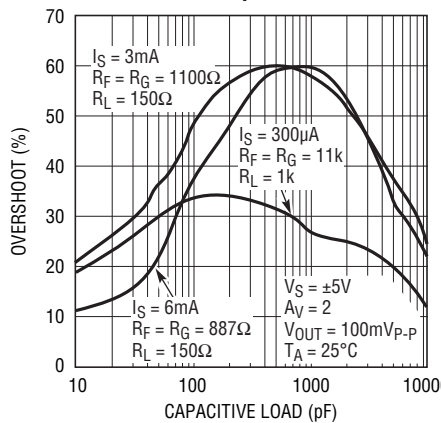

6210 G28

**Maximum Capacitive Load vs Output Series Resistor**

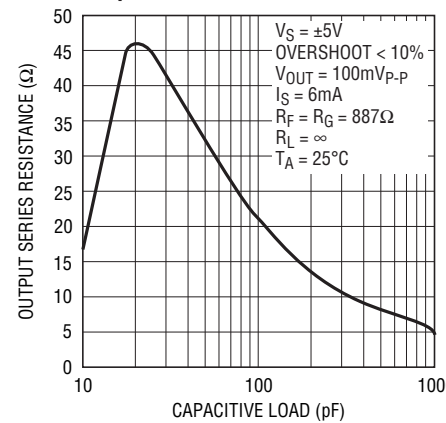

6210 G29

**Maximum Capacitive Load vs Feedback Resistor**

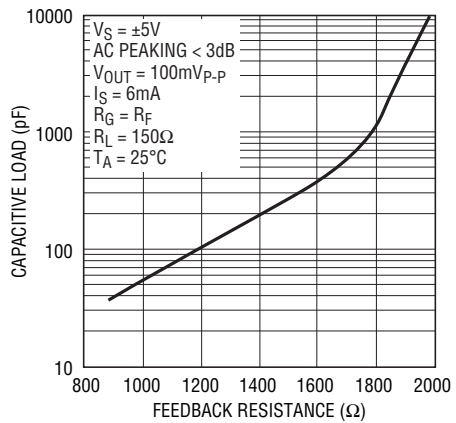

6210 G30

**TYPICAL PERFORMANCE CHARACTERISTICS** (Supply Current Is Measured Per Amplifier)

**-3dB Small-Signal Bandwidth vs Supply Current**



**Slew Rate vs Supply Current**

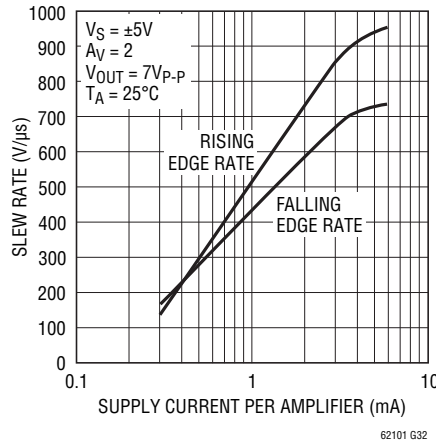

**1MHz 2nd and 3rd Harmonic Distortion vs Supply Current**

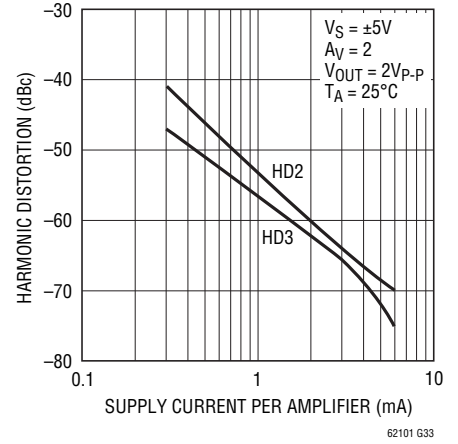

**Small-Signal Transient Response (IS = 6mA per Amplifier)**

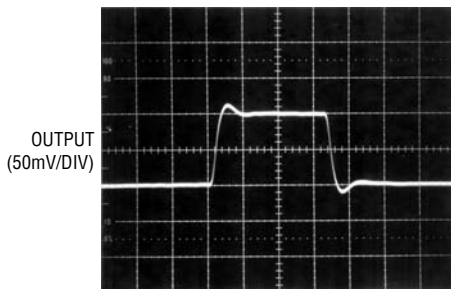

VS = ±5V TIME (10ns/DIV)  
VIN = ±25mV  
RF = RG = 887Ω  
RSET = 20k TO GND  
RL = 150Ω

**Small-Signal Transient Response (IS = 3mA per Amplifier)**

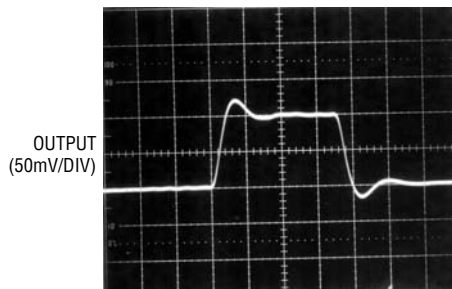

VS = ±5V TIME (10ns/DIV)  
VIN = ±25mV  
RF = RG = 1.1k  
RSET = 56k TO GND  
RL = 150Ω

**Small-Signal Transient Response (IS = 300μA per Amplifier)**

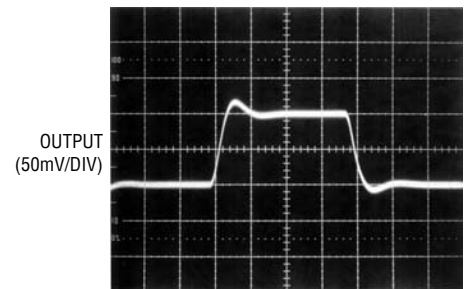

VS = ±5V TIME (100ns/DIV)  
VIN = ±25mV  
RF = RG = 11k  
RSET = 1M TO GND  
RL = 1k

**Large-Signal Transient Response (IS = 6mA per Amplifier)**

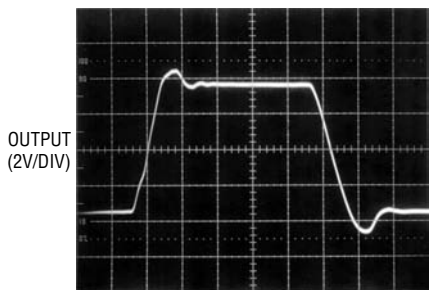

VS = ±5V TIME (10ns/DIV)  
VIN = ±1.75V  
RF = RG = 887Ω  
RSET = 20k TO GND  
RL = 150Ω

**Large-Signal Transient Response (IS = 3mA per Amplifier)**

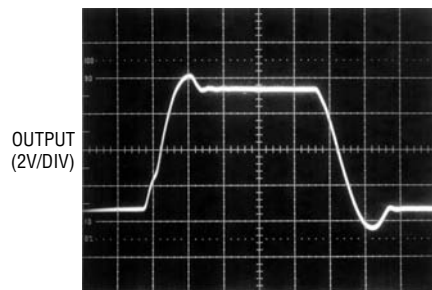

VS = ±5V TIME (10ns/DIV)  
VIN = ±1.75V  
RF = RG = 1.1k  
RSET = 56k TO GND  
RL = 150Ω

**Large-Signal Transient Response (IS = 300μA per Amplifier)**

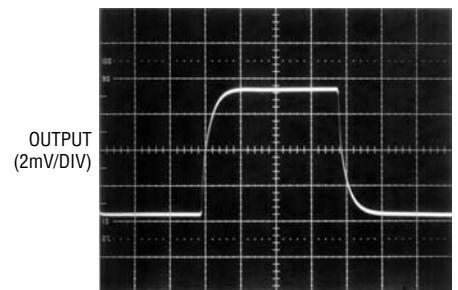

VS = ±5V TIME (100ns/DIV)  
VIN = ±1.75V  
RF = RG = 11k  
RSET = 1M TO GND  
RL = 1k

## APPLICATIONS INFORMATION

### Setting the Quiescent Operating Current ( $I_{SET}$ Pin)

The quiescent bias point of the LT6210/LT6211 is SET with either an external resistor from the  $I_{SET}$  pin to a lower potential or by drawing a current out of the  $I_{SET}$  pin. However, the  $I_{SET}$  pin is not designed to function as a shutdown. The LT6211 uses two entirely independent bias networks, so while each channel can be programmed for a different supply current, neither  $I_{SET}$  pin should be left unconnected. A simplified schematic of the internal biasing structure can be seen in Figure 1. Figure 2 illustrates the results of varying  $R_{SET}$  on 3V and  $\pm 5V$  supplies. Note that shorting the  $I_{SET}$  pin under 3V operation results in a quiescent bias of approximately 6mA. Attempting to bias the LT6210/LT6211 at a current level higher than 6mA by using a smaller resistor may result in instability and decreased performance. However, internal circuitry clamps the supply current of the part at a safe level of approximately 15mA in case of accidental connection of the  $I_{SET}$  pin directly to a negative potential.

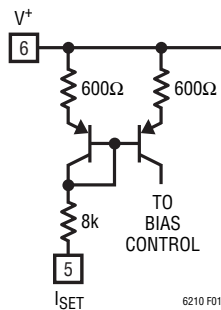

Figure 1. Internal Bias Setting Circuitry



Figure 2. Setting  $R_{SET}$  to Control  $I_S$

### Input Considerations

The inputs of the LT6210/LT6211 are protected by back-to-back diodes. If the differential input voltage exceeds 1.4V, the input current should be limited to less than the absolute maximum ratings of  $\pm 10mA$ . In normal operation, the differential voltage between the inputs is small, so the  $\pm 1.4V$  limit is generally not an issue. ESD diodes protect both inputs, so although the part is not guaranteed to function outside the common mode range, input voltages that exceed a diode beyond either supply will also require current limiting to keep the input current below the absolute maximum of  $\pm 10mA$ .

### Feedback Resistor Selection

The small-signal bandwidth of the LT6210/LT6211 is set by the external feedback resistors and the internal junction capacitances. As a result, the bandwidth is a function of the quiescent supply current, the supply voltage, the value of the feedback resistor, the closed-loop gain and the load resistor. Refer to the Typical AC Performance table for more information.

### Layout and Passive Components

As with all high speed amplifiers, the LT6210/LT6211 require some attention to board layout. Low ESL/ESR bypass capacitors should be placed directly at the positive and negative supply (0.1 $\mu F$  ceramics are recommended). For best transient performance, additional 4.7 $\mu F$  tantalums should be added. A ground plane is recommended and trace lengths should be minimized, especially on the inverting input lead.

### Capacitance on the Inverting Input

Current feedback amplifiers require resistive feedback from the output to the inverting input for stable operation. Capacitance on the inverting input will cause peaking in the frequency response and overshoot in the transient response. Take care to minimize the stray capacitance at the inverting input to ground and between the output and the inverting input. If significant capacitance is unavoidable in a given application, an inverting gain configuration should be considered. When configured inverting, the amplifier inputs do not slew and the effect of parasitics is greatly reduced.

## APPLICATIONS INFORMATION

### Capacitive Loads

The LT6210/LT6211 are stable with any capacitive load. Although peaking and overshoot may result in the AC transient response, the amplifier's compensation decreases bandwidth with increasing output capacitive load to ensure stability. To maintain a response with minimal peaking, the feedback resistor can be increased at the cost of bandwidth as shown in the Typical Performance Characteristics. Alternatively, a small resistor ( $5\Omega$  to  $35\Omega$ ) can be put in series with the output to isolate the capacitive load from the amplifier output. This has the advantage that the amplifier bandwidth is only reduced when the capacitive load is present. The disadvantage of this technique is that the gain is a function of the load resistance.

### Power Supplies

The LT6210/LT6211 will operate on single supplies from 3V to 12V and on split supplies from  $\pm 1.5V$  to  $\pm 6V$ . If split supplies of unequal absolute value are used, input offset voltage and inverting input current will shift from the values specified in the Electrical Characteristics table. Input offset voltage will shift 2mV and inverting input current will shift  $0.5\mu A$  for each volt of supply mismatch.

### Slew Rate

Unlike a traditional voltage feedback op amp, the slew rate of a current feedback amplifier is not independent of the amplifier gain configuration. In a current feedback amplifier, both the input stage and the output stage have slew rate limitations. In the inverting mode, and for gains of 2 or more in the noninverting mode, the signal amplitude between the input pins is small and the overall slew rate

is that of the output stage. For gains less than 2 in the noninverting mode, the overall slew rate is limited by the input stage. The input slew rate of the LT6210/LT6211 on  $\pm 5V$  supplies with an  $R_{SET}$  resistor of 20k ( $I_S = 6mA$ ) is approximately  $600V/\mu s$  and is set by internal currents and capacitances. The output slew rate is additionally constrained by the value of the feedback resistor and internal capacitance. At a gain of 2 with  $887\Omega$  feedback and gain resistors,  $\pm 5V$  supplies and the same biasing as above, the output slew rate is typically  $700V/\mu s$ . Larger feedback resistors, lower supply voltages and lower supply current levels will all reduce slew rate. Input slew rates significantly exceeding the output slew capability can actually decrease slew performance in a positive gain configuration; the cleanest transient response will be obtained from input signals with slew rates slower than  $1000V/\mu s$ .

### Output Swing and Drive

The output stage of the LT6210/LT6211 consists of a pair of class-AB biased common emitters that enable the output to swing rail-to-rail. Since the amplifiers can potentially deliver output currents well beyond the specified minimum short-circuit current, care should be taken not to short the output of the device indefinitely. Attention must be paid to keep the junction temperature of the IC below the absolute maximum rating of  $150^\circ C$  if the output is used to drive low impedance loads. See Note 5 for details. Additionally, the output of the amplifier has reverse-biased ESD diodes connected to each supply. If the output is forced beyond either supply, large currents will flow through these diodes. If the current is limited to 80mA or less, no damage to the part will occur.

## TYPICAL APPLICATIONS

### 3V Cable Driver with Active Termination

Driving back-terminated cables on single supplies usually results in very limited signal amplitude at the receiving end of the cable. However, positive feedback can be used to reduce the size of the series back termination resistor, thereby decreasing the attenuation between the series and shunt termination resistors while still maintaining controlled output impedance from the line-driving amplifier. Figure 3 shows the LT6210 using this “active termination” scheme on a single 3V supply. The amplifier is AC-coupled and in an inverting gain configuration to maximize the input

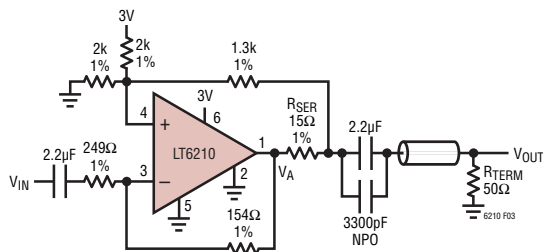

Figure 3. 3V Cable Driver with Active Termination

signal range. The gain from  $V_{IN}$  to the receiving end of the cable,  $V_{OUT}$ , is set to  $-1$ . The effective impedance looking into the amplifier circuit from the cable is  $50\Omega$  throughout the usable bandwidth.

The response of the cable driver with a 1MHz sinusoid is shown in Figure 4. The circuit is capable of transmitting a  $1.5V_{P-P}$  undistorted sinusoid to the  $50\Omega$  termination resistor and has a full signal  $1V_{P-P}$  bandwidth of 50MHz. Small signal  $-3dB$  bandwidth extends from 1kHz to 56MHz with the selected coupling capacitors.



Figure 4. Response of Circuit at 1MHz

## SIMPLIFIED SCHEMATIC



# PACKAGE DESCRIPTION

**DD Package**  
**10-Lead Plastic DFN (3mm × 3mm)**  
 (Reference LTC DWG # 05-08-1699 Rev C)



**RECOMMENDED SOLDER PAD PITCH AND DIMENSIONS**



**NOTE:**

1. DRAWING TO BE MADE A JEDEC PACKAGE OUTLINE M0-229 VARIATION OF (WEED-2). CHECK THE LTC WEBSITE DATA SHEET FOR CURRENT STATUS OF VARIATION ASSIGNMENT
2. DRAWING NOT TO SCALE
3. ALL DIMENSIONS ARE IN MILLIMETERS
4. DIMENSIONS OF EXPOSED PAD ON BOTTOM OF PACKAGE DO NOT INCLUDE MOLD FLASH. MOLD FLASH, IF PRESENT, SHALL NOT EXCEED 0.15mm ON ANY SIDE
5. EXPOSED PAD SHALL BE SOLDER PLATED
6. SHADED AREA IS ONLY A REFERENCE FOR PIN 1 LOCATION ON THE TOP AND BOTTOM OF PACKAGE



## PACKAGE DESCRIPTION

### MS Package 10-Lead Plastic MSOP

(Reference LTC DWG # 05-08-1661 Rev E)

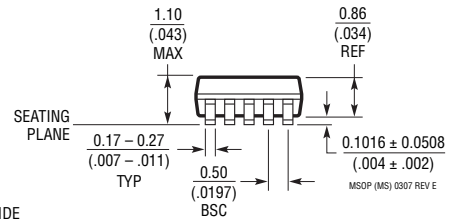
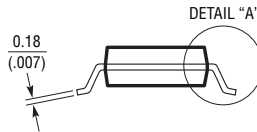
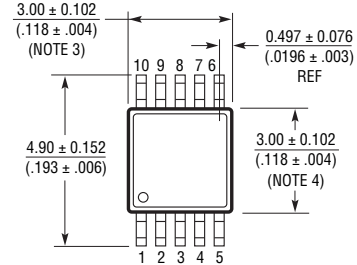
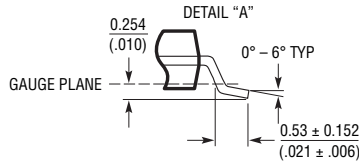
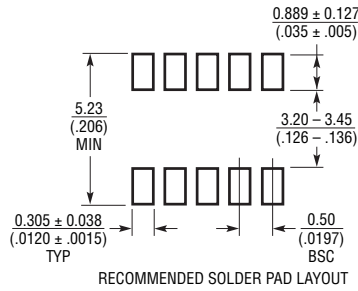

- NOTE:
1. DIMENSIONS IN MILLIMETER/(INCH)
  2. DRAWING NOT TO SCALE
  3. DIMENSION DOES NOT INCLUDE MOLD FLASH, PROTRUSIONS OR GATE BURRS.  
MOLD FLASH, PROTRUSIONS OR GATE BURRS SHALL NOT EXCEED 0.152mm (.006") PER SIDE
  4. DIMENSION DOES NOT INCLUDE INTERLEAD FLASH OR PROTRUSIONS.  
INTERLEAD FLASH OR PROTRUSIONS SHALL NOT EXCEED 0.152mm (.006") PER SIDE
  5. LEAD COPLANARITY (BOTTOM OF LEADS AFTER FORMING) SHALL BE 0.102mm (.004") MAX

### S6 Package 6-Lead Plastic TSOT-23

(Reference LTC DWG # 05-08-1636)

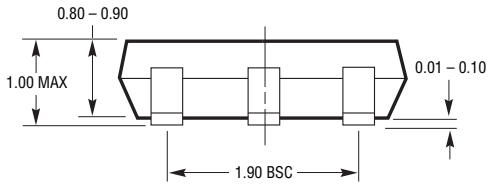
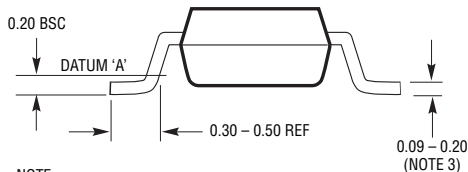
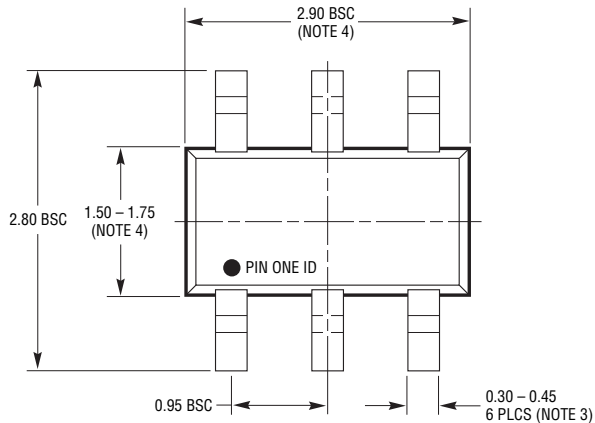
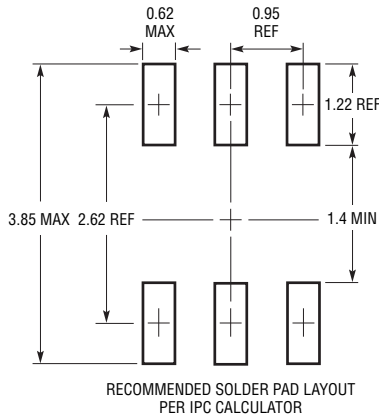

- NOTE:
1. DIMENSIONS ARE IN MILLIMETERS
  2. DRAWING NOT TO SCALE
  3. DIMENSIONS ARE INCLUSIVE OF PLATING
  4. DIMENSIONS ARE EXCLUSIVE OF MOLD FLASH AND METAL BURR
  5. MOLD FLASH SHALL NOT EXCEED 0.254mm

S6 TSOT-23 0302 REV B

**REVISION HISTORY** (Revision history begins at Rev C)

REV	DATE	DESCRIPTION	PAGE NUMBER
C	3/11	Revised the tape and reel part numbers and temperature ranges in the Order Information section.	2

## TYPICAL APPLICATION

### Line Driver with Power Saving Mode

In applications where low distortion or high slew rate are desirable but not necessary at all times, it may be possible to decrease the LT6210 or LT6211's quiescent current when the higher power performance is not required. Figure 5 illustrates a method of setting quiescent current with a FET switch. In the 5V dual supply case pictured, shorting the I<sub>SET</sub> pin through an effective 20k to ground sets the supply current to 6mA, while the 240k resistor at the I<sub>SET</sub> pin with the FET turned off sets the supply current to approximately 1mA. The feedback resistor of 4.02k is selected to minimize peaking in low power mode. The bandwidth

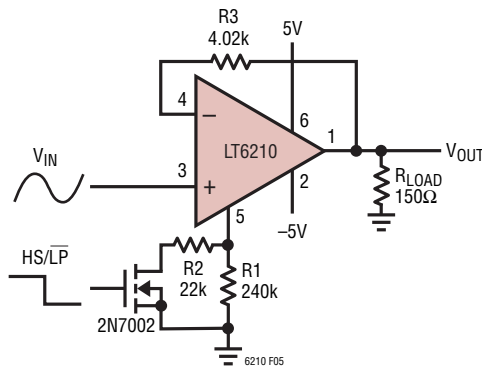

Figure 5. Line Driver with Low Power Mode

of the LT6210 in this circuit increases from about 40MHz in low power mode to over 200MHz in full speed mode, as illustrated in Figure 6. Other AC specs also improve significantly at the higher current setting. The following table shows harmonic distortion at 1MHz with a 2V<sub>p-p</sub> sinusoid at the two selected current levels.

### Harmonic Distortion

LOW POWER		FULL SPEED	
HD2	-53dBc	HD2	-68dBc
HD3	-46dBc	HD3	-77dBc

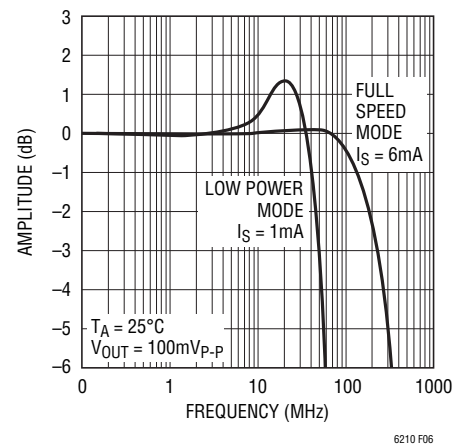

Figure 6. Frequency Response for Full Speed and Low Power Mode

## RELATED PARTS

PART NUMBER	DESCRIPTION	COMMENTS
LT1252/LT1253/LT1254	100MHz Low Cost Video Amplifiers	Single, Dual and Quad Current Feedback Amplifiers
LT1395/LT1396/LT1397	400MHz, 800V/μs Amplifiers	Single, Dual and Quad Current Feedback Amplifiers
LT1398/LT1399	300MHz Amplifiers with Shutdown	Dual and Triple Current Feedback Amplifiers
LT1795	50MHz, 500mA Programmable I <sub>S</sub> Amplifier	Dual Current Feedback Amplifier
LT1806/LT1807	325MHz, 140V/μs Rail-to-Rail I/O Amplifiers	Single and Dual Voltage Feedback Amplifiers
LT1815/LT1816/LT1817	220MHz, 1500V/μs Programmable I <sub>S</sub> Operational Amplifier	Single, Dual and Quad Voltage Feedback Amplifiers