

Anti-Paralle l
APT2X100D20J

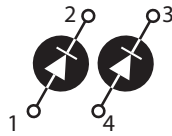

Paralle l
APT2X101D20J



Microsemi
POWER PRODUCTS GROUP

APT2X101D20J 200V 100A
APT2X100D20J 200V 100A

DUAL DIE ISOTOP® PACKAGE ULTRAFAST SOFT RECOVERY RECTIFIER DIODE

PRODUCT APPLICATIONS

- Anti-Parallel Diode
 - Switchmode Power Supply
 - Inverters
- Free Wheeling Diode
 - Motor Controllers
 - Converters
- Snubber Diode
- Uninterruptible Power Supply (UPS)
- Induction Heating
- High Speed Rectifiers

PRODUCT FEATURES

- Ultrafast Recovery Times
- Soft Recovery Characteristics
- Popular SOT-227 Package
- Low Forward Voltage
- High Blocking Voltage
- Low Leakage Current

PRODUCT BENEFITS

- Low Losses
- Low Noise Switching
- Cooler Operation
- Higher Reliability Systems
- Increased System Power Density

MAXIMUM RATINGS

All Ratings: $T_C = 25^\circ\text{C}$ unless otherwise specified.

| Symbol | Characteristic / Test Conditions | APT2X101_100D20J | UNIT |
|----------------|---|------------------|------------------|
| V_R | Maximum D.C. Reverse Voltage | 200 | Volts |
| V_{RRM} | Maximum Peak Repetitive Reverse Voltage | | |
| V_{RWM} | Maximum Working Peak Reverse Voltage | | |
| $I_F(AV)$ | Maximum Average Forward Current ($T_C = 120^\circ\text{C}$, Duty Cycle = 0.5) | 100 | Amps |
| $I_F(RMS)$ | RMS Forward Current (Square wave, 50% duty) | 171 | |
| I_{FSM} | Non-Repetitive Forward Surge Current ($T_J = 45^\circ\text{C}$, 8.3ms) | 1000 | |
| T_J, T_{STG} | Operating and Storage Temperature Range | -55 to 175 | $^\circ\text{C}$ |

STATIC ELECTRICAL CHARACTERISTICS

| Symbol | | MIN | TYP | MAX | UNIT | |
|----------|---|-----|--|-----|------|---------------|
| V_F | Forward Voltage | | $I_F = 100\text{A}$ | 1.0 | 1.1 | Volts |
| | | | $I_F = 200\text{A}$ | 1.4 | | |
| | | | $I_F = 100\text{A}, T_J = 125^\circ\text{C}$ | 0.9 | | |
| I_{RM} | Maximum Reverse Leakage Current | | $V_R = V_R \text{ Rated}$ | | 500 | μA |
| | | | $V_R = V_R \text{ Rated}, T_J = 125^\circ\text{C}$ | | 1000 | |
| C_T | Junction Capacitance, $V_R = 200\text{V}$ | | 400 | | pF | |

DYNAMIC CHARACTERISTICS

APT2X101_100D20J

| Symbol | Characteristic | Test Conditions | MIN | TYP | MAX | UNIT |
|-----------|----------------------------------|---|-----|------|-----|------|
| t_{rr} | Reverse Recovery Time | $I_F = 1A, di_F/dt = -100A/\mu s, V_R = 30V, T_J = 25^\circ C$ | - | 39 | | ns |
| t_{rr} | Reverse Recovery Time | $I_F = 100A, di_F/dt = -200A/\mu s, V_R = 133V, T_C = 25^\circ C$ | - | 60 | | |
| Q_{rr} | Reverse Recovery Charge | | - | 200 | | nC |
| I_{RRM} | Maximum Reverse Recovery Current | | - | 6 | - | Amps |
| t_{rr} | Reverse Recovery Time | $I_F = 100A, di_F/dt = -200A/\mu s, V_R = 133V, T_C = 125^\circ C$ | - | 110 | | ns |
| Q_{rr} | Reverse Recovery Charge | | - | 840 | | nC |
| I_{RRM} | Maximum Reverse Recovery Current | | - | 15 | - | Amps |
| t_{rr} | Reverse Recovery Time | $I_F = 100A, di_F/dt = -1000A/\mu s, V_R = 133V, T_C = 125^\circ C$ | - | 80 | | ns |
| Q_{rr} | Reverse Recovery Charge | | - | 1910 | | nC |
| I_{RRM} | Maximum Reverse Recovery Current | | - | 44 | | Amps |

THERMAL AND MECHANICAL CHARACTERISTICS

| Symbol | Characteristic / Test Conditions | MIN | TYP | MAX | UNIT |
|-----------------|--|-----|------|-----|--------------|
| $R_{\theta JC}$ | Junction-to-Case Thermal Resistance | | | .42 | $^\circ C/W$ |
| $R_{\theta JA}$ | Junction-to-Ambient Thermal Resistance | | | 20 | |
| W_T | Package Weight | | 1.03 | | oz |
| | | | 29.2 | | g |
| Torque | Maximum Terminal & Mounting Torque | | | 10 | lb•in |
| | | | | 1.1 | N•m |

Microsemi Reserves the right to change, without notice, the specifications and information contained herein.

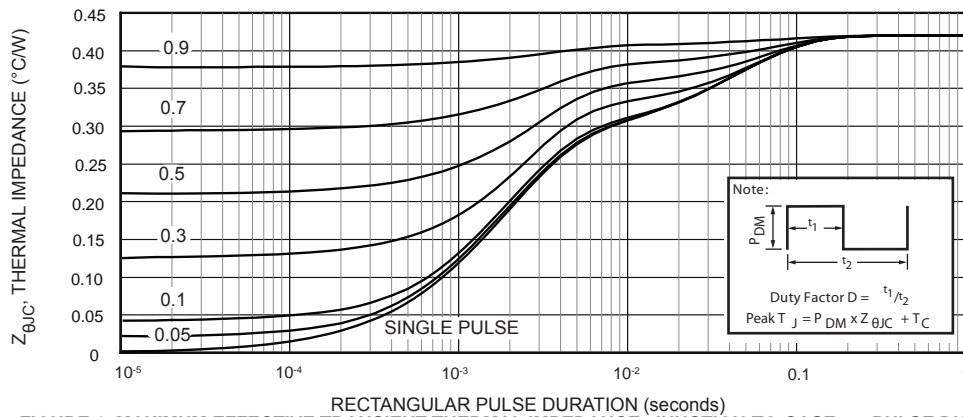

FIGURE 1. MAXIMUM EFFECTIVE TRANSIENT THERMAL IMPEDANCE, JUNCTION-TO-CASE vs. PULSE DURATION

TYPICAL PERFORMANCE CURVES

APT2X101_100D20J

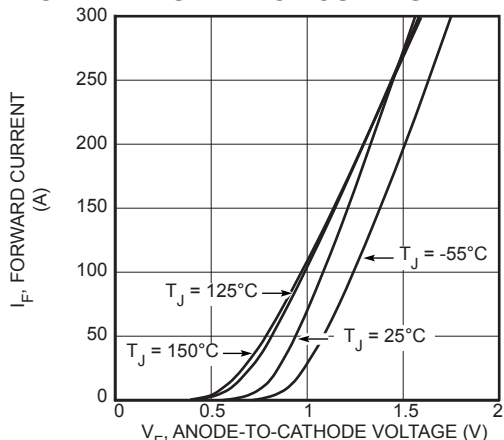

Figure 2. Forward Current vs. Forward Voltage

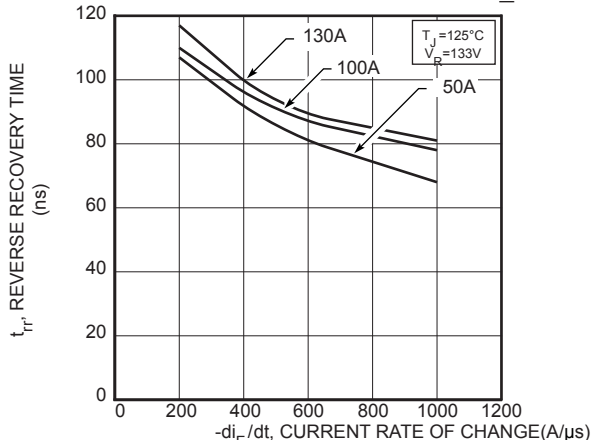

Figure 3. Reverse Recovery Time vs. Current Rate of Change

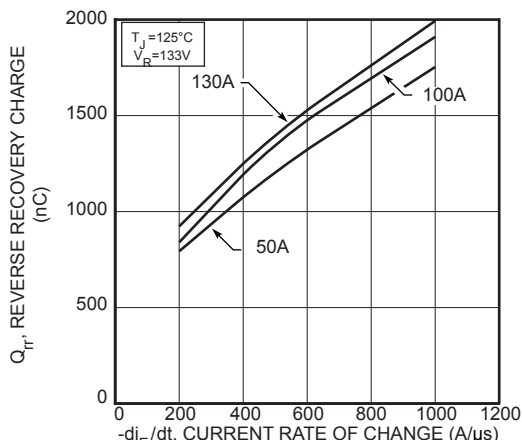

Figure 4. Reverse Recovery Charge vs. Current Rate of Change

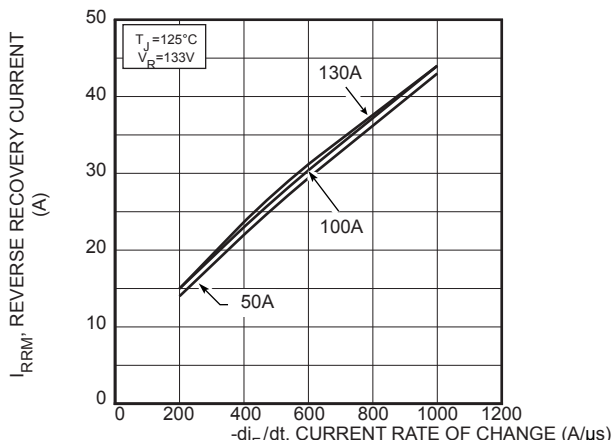

Figure 5. Reverse Recovery Current vs. Current Rate of Change

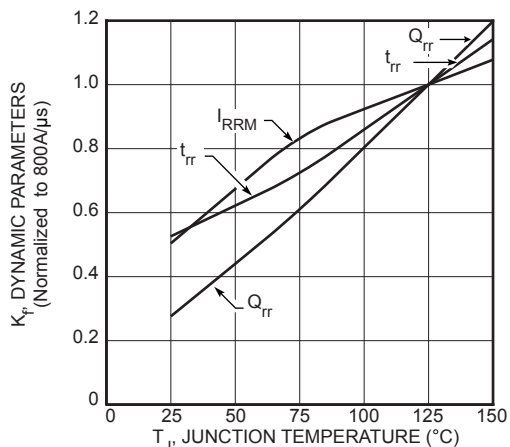

Figure 6. Dynamic Parameters vs. Junction Temperature

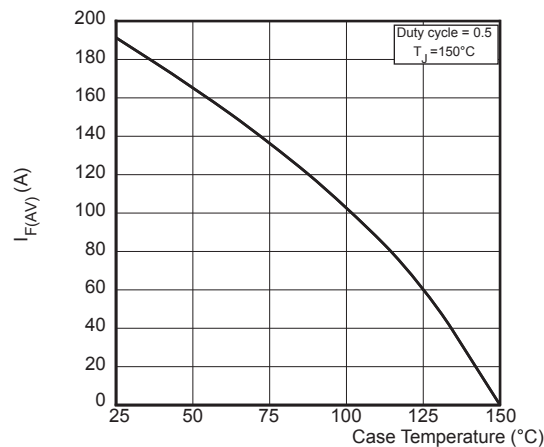

Figure 7. Maximum Average Forward Current vs. Case Temperature

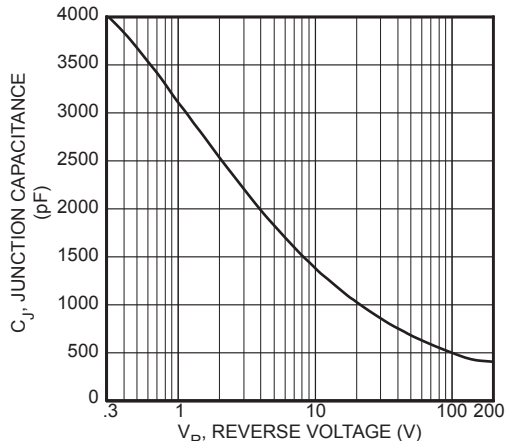

Figure 8. Junction Capacitance vs. Reverse Voltage

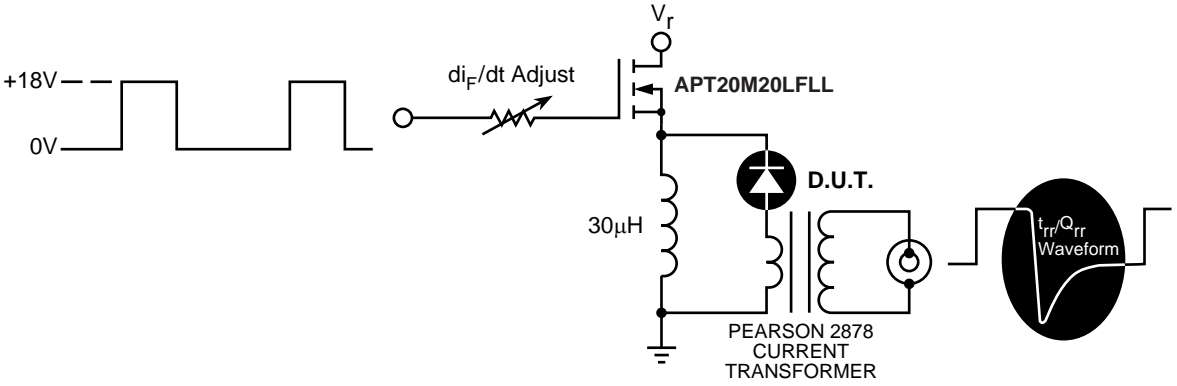

Figure 9. Diode Test Circuit

- 1 I_F - Forward Conduction Current
- 2 di_F/dt - Rate of Diode Current Change Through Zero Crossing.
- 3 I_{RRM} - Maximum Reverse Recovery Current.
- 4 t_{rr} - Reverse Recovery Time, measured from zero crossing where diode current goes from positive to negative, to the point at which the straight line through I_{RRM} and $0.25 \cdot I_{RRM}$ passes through zero.
- 5 Q_{rr} - Area Under the Curve Defined by I_{RRM} and t_{rr} .

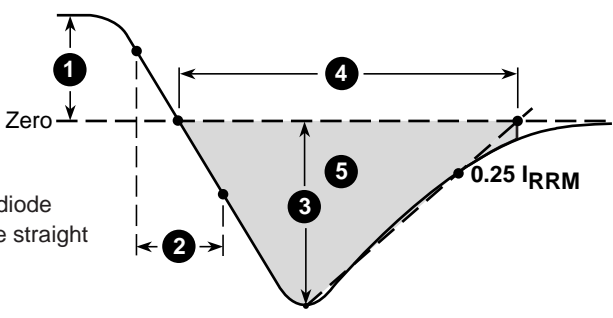

Figure 10, Diode Reverse Recovery Waveform and Definitions

SOT-227 Package Outline

