

## Data Sheet

---

### Description

The ASMW-Lx00 surface-mount LEDs use AlInGaP chip technology with superior package design to enable them to produce higher light output with better flux performance. They can be driven at high current and are able to dissipate the heat more efficiently resulting in better performance with higher reliability.

These LEDs are able to be operated under a wide range of environment conditions, making it ideal for various applications.

To facilitate easy pick-and-place assembly, the LEDs are packed in tape and reel. Every reel is shipped in single flux and color bin to provide good uniformity.

### Features

- Available in amber, red orange, and red
- Moisture sensitivity level 3
- High reliability with silicone encapsulation
- Low package profile and large emitting area
- Enhanced corrosion resistance

### Applications

- Specialty and architectural lighting
- Gaming and vending machine backlighting
- Industrial lighting, for example, tower light
- Industrial equipment indicator

**CAUTION:** This LED is Class 2 ESD sensitive per ANSI/ESDA/JEDEC JS-001. Please observe appropriate precautions during handling and processing. Refer to Application Note AN-1142 for additional details.

**Figure 1 Package Dimensions**

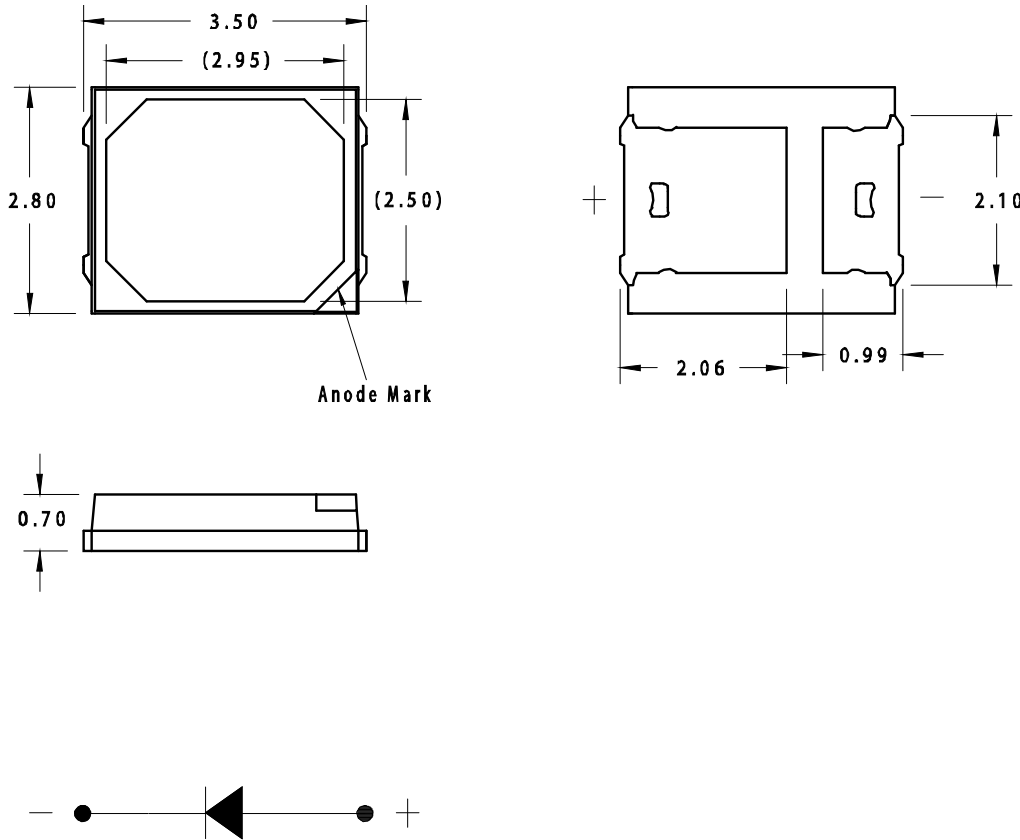

**NOTE**

- All dimensions are in mm.
- Dimensions in brackets are for reference only.
- Tolerance  $\pm 0.2$  mm unless otherwise specified.
- Encapsulation = silicone.
- Terminal finish = silver plating.

**Device Selection Guide ( $T_J = 25^\circ\text{C}$ ,  $I_F = 150$  mA)**

Part Number	Color	Luminous Flux (lm) <sup>a, b</sup>			Luminous Intensity (cd) <sup>c</sup>
		Min.	Typ.	Max.	Typ.
ASMW-LA00-AUW0E	Amber	26.0	28.5	35.0	9.7
ASMW-LH00-AUW0E	Red orange	26.0	29.2	35.0	10.1
ASMW-LR00-ASU0E	Red	21.0	24.3	29.0	8.4

- a. Luminous flux is the total flux output as measured with an integrating sphere at a single current pulse condition.
- b. Luminous flux tolerance:  $\pm 12\%$ .
- c. For reference only.

## Absolute Maximum Ratings

Parameter	Amber/Red Orange/ Red	Units
DC Forward Current <sup>a</sup>	200	mA
Peak Forward Current <sup>b</sup>	300	mA
Power Dissipation	520	mW
Reverse Voltage	Not recommended for reverse bias	
Junction Temperature	125	°C
Operating Temperature Range	-40 to +100	°C
Storage Temperature Range	-40 to +100	°C

a. Derate linearly as shown in [Figure 9](#) and [Figure 10](#).

b. Duty Factor = 10%, Frequency = 1kHz.

## Optical and Electrical Characteristics (T<sub>J</sub> = 25°C)

### Amber

Parameter	Min.	Typ.	Max.	Units	Remark
Viewing Angle, 2θ <sub>1/2</sub> <sup>a</sup>	—	120	—	Deg	
Forward Voltage, V <sub>F</sub> <sup>b</sup>	1.8	2.30	2.6	V	I <sub>F</sub> = 150 mA
Reverse Current, I <sub>R</sub> <sup>c</sup>	—	—	10	μA	V <sub>R</sub> = 4V
Dominant wavelength	584.5	589.0	597.0	nm	I <sub>F</sub> = 150 mA
Peak wavelength	—	592.0	—	nm	I <sub>F</sub> = 150 mA
Thermal Resistance, R <sub>θJ-S</sub>	—	25	—	°C/W	LED junction to solder point

- a. 2θ<sub>1/2</sub> is the off axis angle where the luminous intensity is ½ of the peak intensity.
- b. Forward voltage tolerance = ±0.1V.
- c. Indicates production final test condition only. Long-term reverse biasing is not recommended.

### Red Orange

Parameter	Min.	Typ.	Max.	Units	Remark
Viewing Angle, 2θ <sub>1/2</sub> <sup>a</sup>	—	120	—	Deg	
Forward Voltage, V <sub>F</sub> <sup>b</sup>	1.8	2.16	2.6	V	I <sub>F</sub> = 150 mA
Reverse Current, I <sub>R</sub> <sup>c</sup>	—	—	10	μA	V <sub>R</sub> = 4V
Dominant wavelength	611.0	613.0	620.0	nm	I <sub>F</sub> = 150 mA
Peak wavelength	—	620.0	—	nm	I <sub>F</sub> = 150 mA
Thermal Resistance, R <sub>θJ-S</sub>	—	25	—	°C/W	LED junction to solder point

- a. 2θ<sub>1/2</sub> is the off axis angle where the luminous intensity is ½ of the peak intensity.
- b. Forward voltage tolerance = ±0.1V.
- c. Indicates production final test condition only. Long-term reverse biasing is not recommended.

### Red

Parameter	Min.	Typ.	Max.	Units	Remark
Viewing Angle, 2θ <sub>1/2</sub> <sup>a</sup>	—	120	—	Deg	
Forward Voltage, V <sub>F</sub> <sup>b</sup>	1.8	2.13	2.6	V	I <sub>F</sub> = 150 mA
Reverse Current, I <sub>R</sub> <sup>c</sup>	—	—	10	μA	V <sub>R</sub> = 4V
Dominant wavelength	620.0	623.0	635.0	nm	I <sub>F</sub> = 150 mA
Peak wavelength	—	633.0	—	nm	I <sub>F</sub> = 150 mA
Thermal Resistance, R <sub>θJ-S</sub>	—	25	—	°C/W	LED junction to solder point

- a. 2θ<sub>1/2</sub> is the off axis angle where the luminous intensity is ½ of the peak intensity.
- b. Forward voltage tolerance = ±0.1V.
- c. Indicates production final test condition only. Long-term reverse biasing is not recommended.

## Part Numbering System

A S M W - L x<sub>1</sub> 0 0 - x<sub>2</sub> x<sub>3</sub> x<sub>4</sub> x<sub>5</sub> x<sub>6</sub>

Code	Description	Options		Remark
x <sub>1</sub>	Color	A	Amber	
		H	Red orange	
		R	Red	
x <sub>2</sub>	Die technology	A	AllnGaP	
x <sub>3</sub>	Minimum flux bin	S	21.0–23.0 lm	
x <sub>4</sub>	Maximum flux bin	T	23.0–26.0 lm	
		U	26.0–29.0 lm	
		V	29.0–32.0 lm	
		W	32.0–35.0 lm	
x <sub>5</sub>	Color bin	0	Full color distribution	
		B	Color bin 2 and 3 only	
		C	Color bin 3 and 4 only	
		D	Color bin 4 and 5 only	
		E	Color bin 5 and 6 only	
		H	Color bin 2, 3, and 4 only	
		J	Color bin 3, 4, and 5 only	
		K	Color bin 4, 5, and 6 only	
		N	Color bin 2, 3, 4, and 5 only	
		P	Color bin 3, 4, 5, and 6 only	
		S	Color bin 2, 3, 4, 5, and 6 only	
x <sub>6</sub>	Test option	E	Test current = 150 mA	

Part Number Example:

### ASMW-LA00-AUW0E

- x<sub>1</sub> = A      Amber Color
- x<sub>2</sub> = A      AllnGaP die
- x<sub>3</sub> = U      Minimum flux bin U
- x<sub>4</sub> = W      Maximum flux bin W
- x<sub>5</sub> = 0      Full color distribution
- x<sub>6</sub> = E      Test current = 150 mA

## Bin Information

### Flux Bin (CAT)

Bin ID	Luminous Flux (lm)	
	Min.	Max.
S	21.0	23.0
T	23.0	26.0
U	26.0	29.0
V	29.0	32.0
W	32.0	35.0

Tolerance:  $\pm 12\%$

### Color Bin (BIN) – Amber

Bin ID	Min. (nm)	Max. (nm)
2	584.5	587.0
3	587.0	589.5
4	589.5	592.0
5	592.0	594.5
6	594.5	597.0

Tolerance:  $\pm 1\text{nm}$

### Color Bin (BIN) – Red Orange

Bin ID	Min. (nm)	Max. (nm)
1	611.0	616.0
2	616.0	620.0

Tolerance:  $\pm 1\text{nm}$

### Color Bin (BIN) – Red

Bin ID	Min. (nm)	Max. (nm)
—	620.0	635.0

Tolerance:  $\pm 1\text{nm}$

Example of bin information on reel and packaging label:

CAT: S      Flux bin S  
 BIN: 2      Color bin 2  
 VF: H14      Vf bin H14

### Forward Voltage Bin (VF)

Bin ID	Forward Voltage (V)	
	Min.	Max.
H11	1.8	1.9
H12	1.9	2.0
H13	2.0	2.1
H14	2.1	2.2
H15	2.2	2.3
H16	2.3	2.4
H17	2.4	2.5
H18	2.5	2.6

Tolerance:  $\pm 0.1\text{V}$

**Figure 2 Relative Luminous Flux vs. Forward Current**

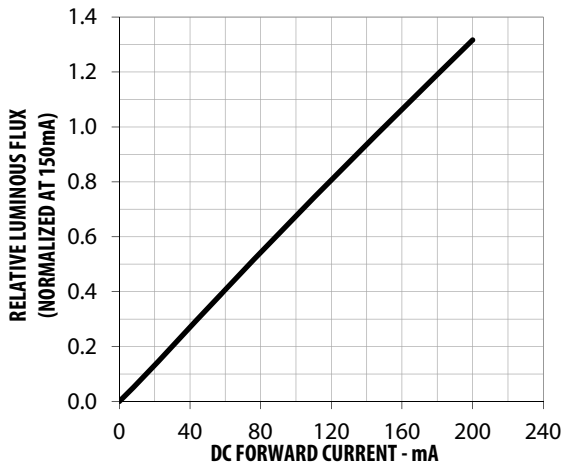

**Figure 3 Forward Current vs. Forward Voltage**

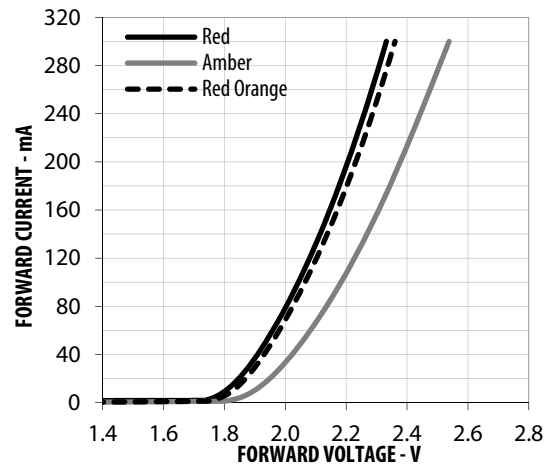

**Figure 4 Dominant Wavelength Shift vs. Forward Current**

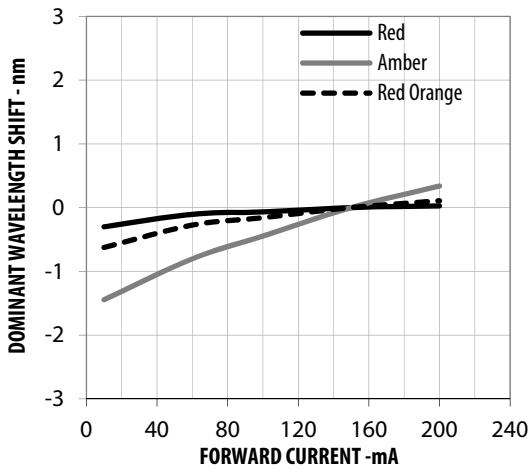

**Figure 5 Relative Luminous Flux vs. Junction Temperature**

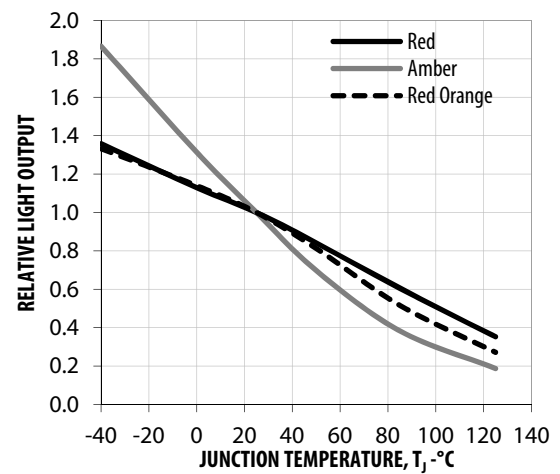

**Figure 6 Forward Voltage Shift vs. Junction Temperature**

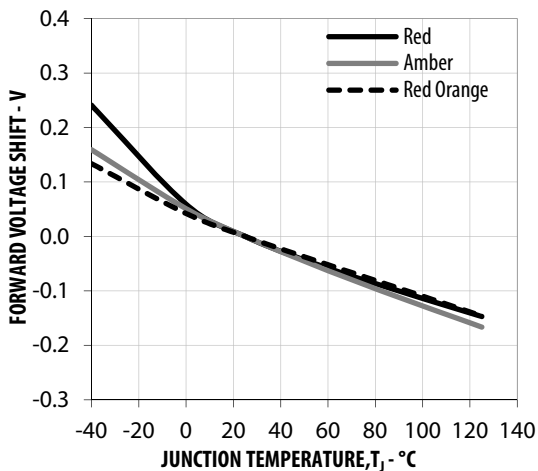

**Figure 7 Dominant Wavelength Shift vs. Junction Temperature**

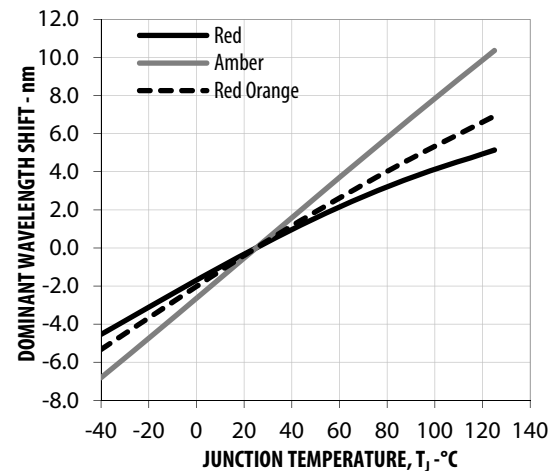

Figure 8 Relative Spectral Emission

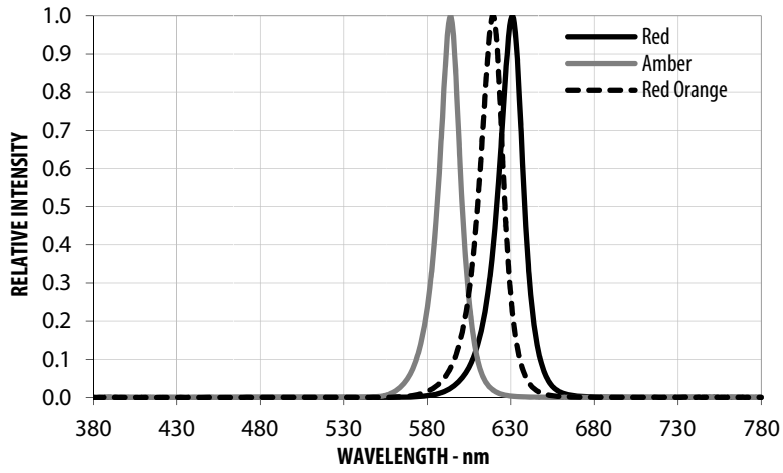

Figure 9 Derating Curve According to Ambient Temperature – $T_A$

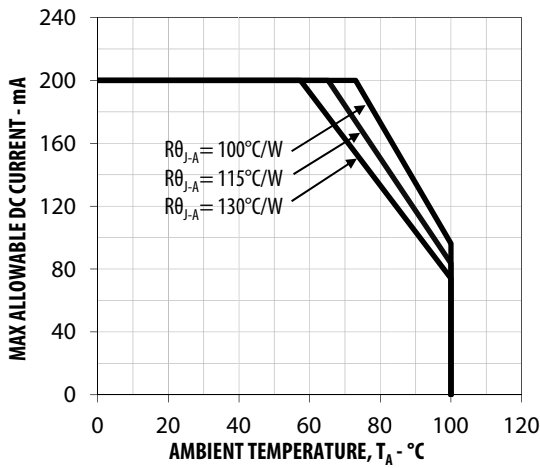

Figure 10 Derating Curve According to Solder Point Temperature – $T_S$

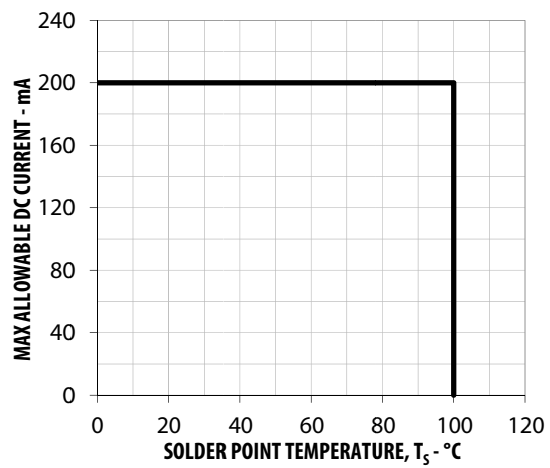

Figure 11 Pulse Handling Capability at  $T_S \leq 100^\circ\text{C}$

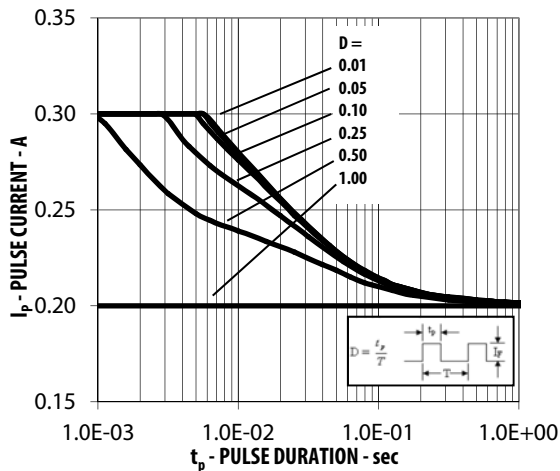
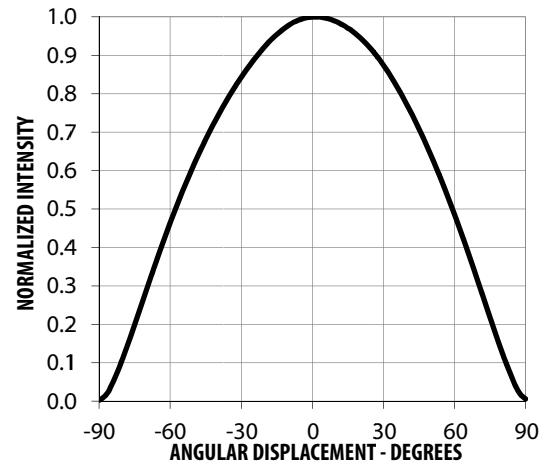
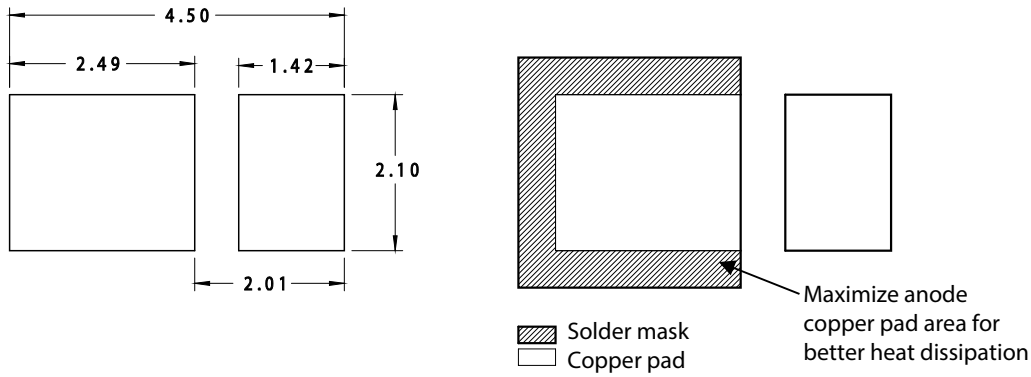

Figure 12 Radiation Pattern

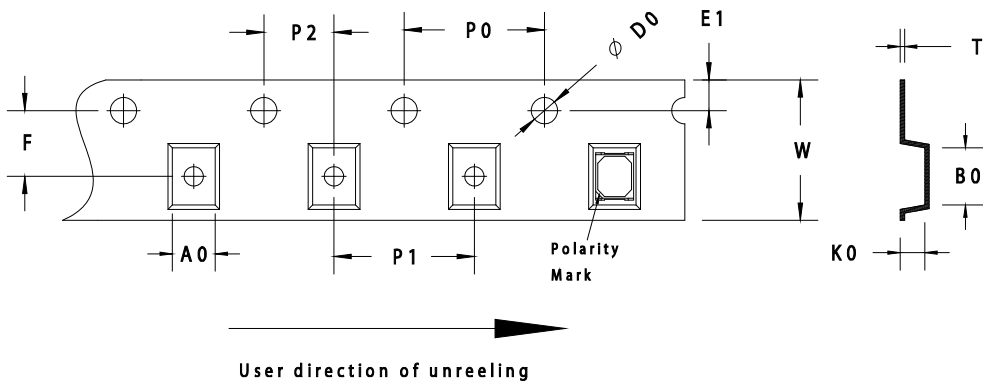



**Figure 13 Recommended Soldering Land Pattern (in mm)**

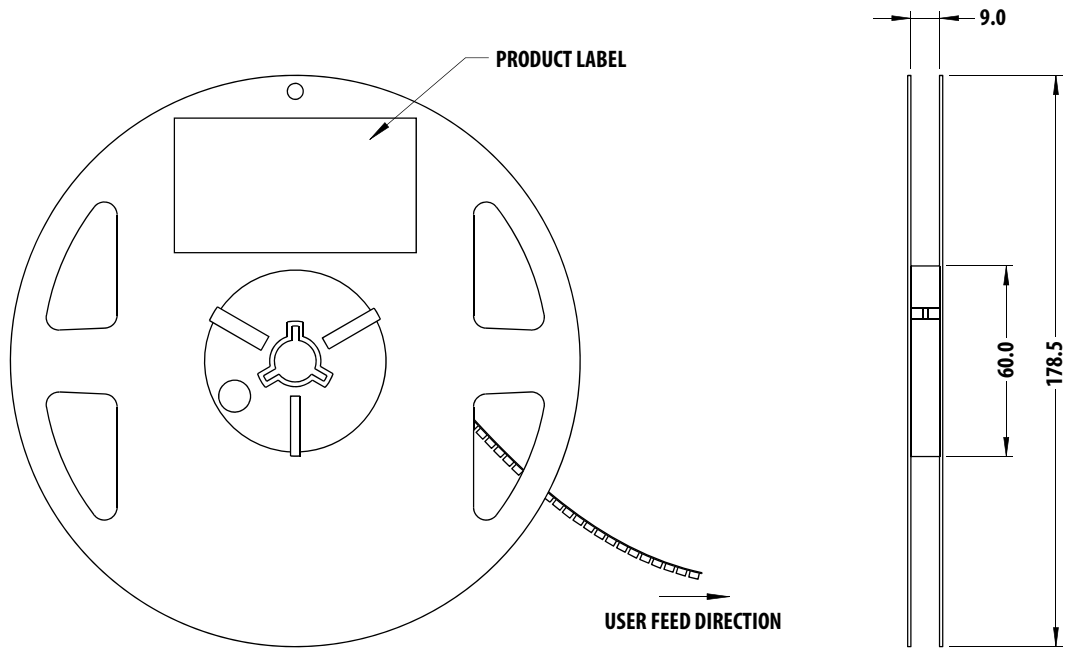

**Figure 14 Carrier Tape Dimensions**



F	P0	P1	P2	D0	E1	W	T	B0	K0	A0
3.5±0.05	4.0±0.10	4.0±0.1	2.0±0.05	1.55±0.05	1.75±0.10	8.0±0.20	0.20±0.05	3.80±0.10	1.05±0.10	3.1±0.10

**Figure 15 Reel Dimension**



Unit: mm.

## Precautionary Notes

### Soldering

**Figure 16 Recommended Pb-free Reflow Soldering Condition**

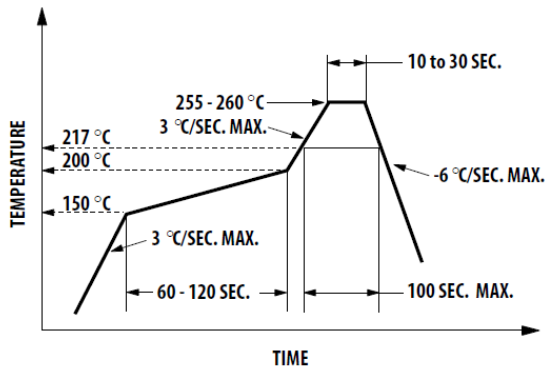

- Reflow soldering must not be done more than twice.
- Do not apply any pressure or force on the LED during reflow and after reflow when the LED is still hot.
- Use reflow soldering to solder the LED. Use hand soldering only for rework if unavoidable, but it must be strictly controlled to the following conditions:
  - Solder iron tip temperature = 315°C maximum
  - Solder duration = 3s maximum
  - After hand soldering, the LED must be allowed to cool down prior to touch up soldering.
- Do not touch the LE package body with the soldering iron except for the soldering terminals as it might cause damage to the LED.
- Confirm beforehand whether the functionality and performance of the LED is affected by soldering with hand soldering.

### Handling Precautions

The encapsulation material of the LED is made of silicone for better product reliability. Compared to epoxy encapsulant that is hard and brittle, silicone is softer and flexible. Special handling precaution must be observed during assembly of silicone encapsulated LED products. Failure to comply might lead to damage and premature failure of the LED. Refer to Application Note AN5288, *Silicone Encapsulation for LED: Advantages and Handling Precautions*, for more information.

- Do not poke sharp objects into the silicone encapsulant. Sharp objects, such as tweezers or syringes, might apply excessive force or even pierce through the silicone and induce failures to the LED die or wire bond.

- Do not touch the silicone encapsulant. Uncontrolled force acting on the silicone encapsulant might result in excessive stress on the wire bond. Hold the LED only by the body.
- Do not stack assembled PCBs together. Use an appropriate rack to hold the PCBs.
- The surface of silicone material attracts dust and dirt easier than epoxy due to its surface tackiness. To remove foreign particles on the surface of the silicone, use a cotton bud with isopropyl alcohol (IPA). During cleaning, rub the surface gently without putting much pressure on the silicone. Ultrasonic cleaning is not recommended.
- For automated pick and place, Broadcom has tested the following nozzle size to work well with this LED. However, due to the possibility of variations in other parameters, such as pick and place machine maker/model and other settings of the machine, verify that the selected nozzle will not damage the LED.

**Figure 17 Nozzle Size**

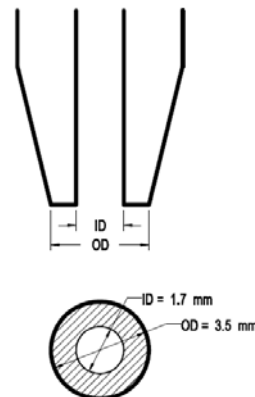

### Handling of Moisture-Sensitive Devices

This product has a Moisture Sensitive Level 3 rating per JEDEC J-STD-020. Refer to Broadcom Application Note AN5305, *Handling of Moisture Sensitive Surface Mount Devices*, for additional details and a review of proper handling procedures.

- Before use:
  - An unopened moisture barrier bag (MBB) can be stored at < 40°C / 90% RH for 12 months. If the actual shelf life has exceeded 12 months and the humidity indicator card (HIC) indicates that baking is not required, it is safe to reflow the LEDs per the original MSL rating.
  - Do not open the MBB prior to assembly (for example, for IQC).
- Control after opening the MBB:
  - Read the HIC immediately upon opening of MBB.

- Keep the LEDs at < 30°C / 60% RH at all times. All high temperature-related processes, including soldering, curing, or rework, must be completed within 168 hours.
- Control for unfinished reel:  
Store unused LEDs in a sealed MBB with desiccant or desiccators at < 5% RH.
- Control of assembled boards:  
If the PCB soldered with the LEDs is to be subjected to other high temperature processes, store the PCB in a sealed MBB with desiccant or desiccators at < 5% RH to ensure that all LEDs have not exceeded their floor life of 168 hours.
- Baking is required if the following conditions exist:
  - The HIC indicator indicates a change in color for 10 percent and 5 percent as stated on the HIC.
  - The LEDs are exposed to condition of > 30°C / 60% RH at any time.
  - The LED floor life exceeded 168 hours.

The recommended baking condition is: 60°C ±5°C for 20 hours.

Baking should only be done once.
- Storage:  
The soldering terminals of these Broadcom LEDs are silver plated. If the LEDs are exposed in an ambient environment for too long, the silver plating might oxidize, thus affecting its solderability performance. As such, keep unused LEDs in a sealed MBB with desiccant or in desiccators at < 5% RH.

### Application Precautions

- The drive current of the LED must not exceed the maximum allowable limit across temperature as stated in the data sheet. Constant current driving is recommended to ensure consistent performance.
- LEDs exhibit slightly different characteristics at different drive currents that might result in larger performance variation (for example, intensity, wavelength, and forward voltage). Set the application current as close as possible to the test current to minimize these variations.
- The LED is not intended for reverse bias. Use other appropriate components for such purposes. When driving the LED in matrix form, ensure that the reverse bias voltage does not exceed the allowable limit of the LED.
- This LED is designed to have enhanced gas corrosion resistance. Its performance has been tested according to the following conditions:
  - IEC 60068-2-43: 25°C/75% RH, H<sub>2</sub>S 15 ppm, 21 days
  - IEC 60068-2-42: 25°C/75% RH, SO<sub>2</sub> 25 ppm, 21 days

- IEC 60068-2-60: 25°C/75% RH, SO<sub>2</sub> 200 ppb, NO<sub>2</sub> 200 ppb, H<sub>2</sub>S 10 ppb, Cl<sub>2</sub> 10 ppb, 21 days

As actual application conditions might not be exactly similar to the test conditions, verify that the LED will not be damaged by prolonged exposure in the intended environment.

- Avoid rapid change in ambient temperature, especially in high humidity environments because this will cause condensation on the LED.
- If the LED is intended to be used in harsh or outdoor environments, protect the LED by means of protective cover against damages caused by rain water, dust, oil, corrosive gases, external mechanical stress, and so on.

### Thermal Management

Optical, electrical and reliability characteristics of LED are affected by temperature. Keep the junction temperature (T<sub>J</sub>) of the LED below allowable limit at all times. T<sub>J</sub> can be calculated as follows:

$$T_J = T_S + R\theta_{JS} \times I_F \times V_{fmax}$$

- where T<sub>S</sub> = LED solder point temperature as shown in Figure 18 (°C)
- Rθ<sub>JS</sub> = Thermal resistance from junction to solder point (°C/W)
- I<sub>F</sub> = Forward current (A)
- V<sub>fmax</sub> = Maximum forward voltage (V)

Figure 18 LED Solder Point

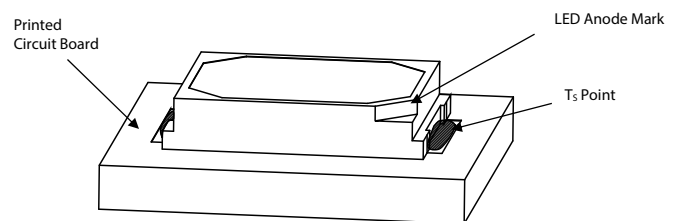

To measure the soldering point temperature, mount a thermocouple on the T<sub>S</sub> point as shown in Figure 18. Verify the T<sub>S</sub> of the LED in the final product to ensure that the LEDs are operated within all maximum ratings stated in the data sheet.

### Eye Safety and Precautions

LEDs may pose optical hazards when in operation. Do not look directly at operating LEDs as it may be harmful to the eyes. For safety reasons, use appropriate shielding or personnel protection equipments.

## Disclaimer

Broadcom's products are not specifically designed, manufactured, or authorized for sale as parts, components, or assemblies for the planning, construction, maintenance, or direct operation of a nuclear facility or for use in medical devices or applications. The customer is solely responsible, and waives all rights to make claims against Broadcom or its suppliers, for all loss, damage, expense, or liability in connection with such use.

---

For product information and a complete list of distributors, please go to our web site: [www.broadcom.com](http://www.broadcom.com).

Broadcom, the pulse logo, Connecting everything, Avago Technologies, Avago, and the A logo are among the trademarks of Broadcom and/or its affiliates in the United States, certain other countries and/or the EU.

Copyright © 2017 by Broadcom. All Rights Reserved.

The term "Broadcom" refers to Broadcom Limited and/or its subsidiaries. For more information, please visit [www.broadcom.com](http://www.broadcom.com).

Broadcom reserves the right to make changes without further notice to any products or data herein to improve reliability, function, or design.

Information furnished by Broadcom is believed to be accurate and reliable. However, Broadcom does not assume any liability arising out of the application or use of this information, nor the application or use of any product or circuit described herein, neither does it convey any license under its patent rights nor the rights of others.

ASMW-LXXX-DS100 – February 27, 2017

