

EM11B 1 1 mm Size Metal Shaft Magnetic Type

Compact 10.8 × 11 mm (W×D) encoder with long life of 1 million cycles



Encoders



Typical Specifications

Items	Items
Rating	10mA 5V±5% DC
Operating life	1,000,000 cycles
Operating temperature range	-30°C to +85°C

Product Line

Actuator length (mm)	Detent torque (mN·m)	Number of detent	Number of pulse	Operating direction	Push-on switch	Response time	Minimum order unit (pcs.)		Product No.
							Japan	Export	
15	10±5	16	16	Vertical	With	1.3μs. (typ)	1,000	2,000	EM11B16140AE

Packing Specifications

Tray

Number of packages (pcs.)		Export package measurements (mm)
1 case /Japan	1 case /export packing	
1,000	2,000	526×370×191

Dimensions

Unit:mm

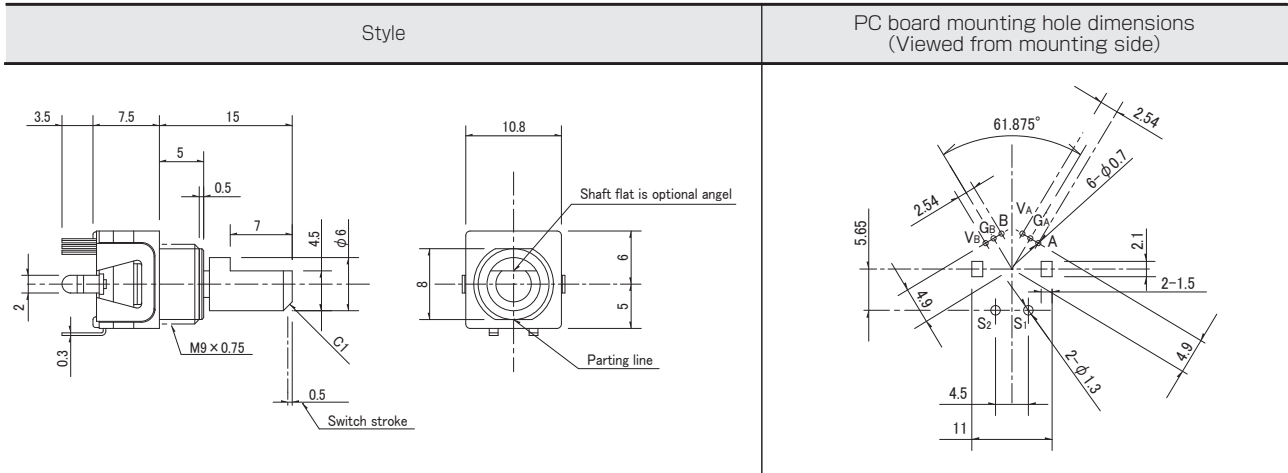

Block Diagram

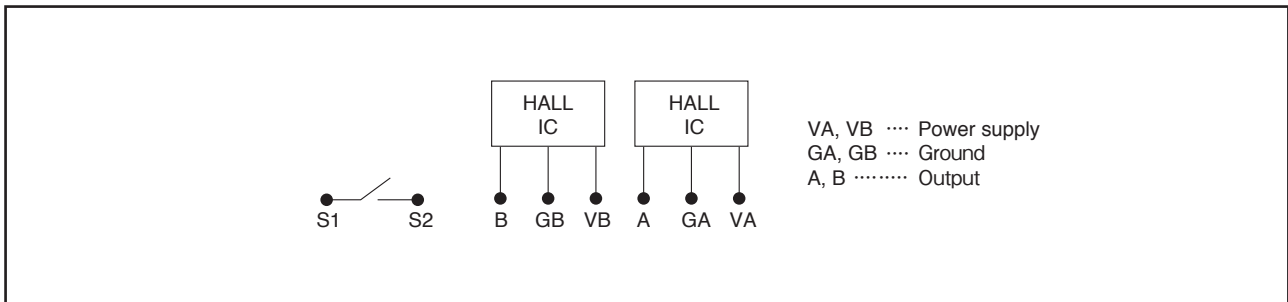

Notes

1. This products uses a Hall IC. Be aware of ESD damages.
2. Custom design for shaft configuration and mount height are available upon request.

Refer to P.287 for switches.
Refer to P.315 for soldering conditions.

11 mm Size Metal Shaft Magnetic Type/Switch Specifications

Switch type		Momentary push switch
Contact arrangement		Single pole and single throw (Push-on)
Travel (mm)		$0.5 \pm \begin{smallmatrix} 0.3 \\ 0.2 \end{smallmatrix}$
Operating force		$5.5 \pm 3N$
Operating life		1,000,000 times
Electrical performance	Rating	5mA 5V DC (50mA 12V DC max. ratings)
	Contact resistance	500mΩ max. for initial period, 5Ω max. after operating life.
	Insulation resistance	100MΩ min. 100V DC
	Voltage proof	250V AC for 1 minute or 300V AC for 2 second

Encoders

Metal Shaft













Insulated Shaft

Hollow Shaft

Ring Type

Encoders

List of Varieties

Type		Metal shaft											
		11mm size						20mm size					
Series		EC111		EC11K		EC11J		EM11B	EC20A	EM20B			
Photo													
Output		Self-return switch			Incremental (Two phase A and B)								
Shaft types		Single-shaft											
Operating direction		Vertical											
Number of pulse / Number of detent		—		9/18 15/30			16/16		18/18	40/40			
Features		—		—		Surface Mount type		Magnetic type	—	Magnetic type			
Dimensions (mm)		W		11.7						10.8	20.2	20	
		D		13		12		14.2		11	19.2	22.25	
		H		5		4.5			7.5		10	13	
Operating temperature range		-40°C to +85°C						-30°C to +85°C	-30°C to +80°C	-10°C to +70°C			
Operating life		15,000 cycles		100,000 cycles			1,000,000 cycles		30,000 cycles	500,000 cycles			
Automotive use		●		●		●		●	●	—			
Life cycle (availability)													
Electrical performance		Rating		10mA 5V DC				10mA 5V±5% DC	1mA 5V DC	10mA 5V±5% DC			
		Max./min. operating current (Resistive load)		10mA / 1mA				15mA / —		—	15mA / —		
		Insulation resistance		100MΩ min. 250V DC						100MΩ min.100V DC	10MΩ min. 50V DC	100MΩ min. 250V DC	
		Voltage proof		300V AC for 1 minute or 360V AC for 2s		300V AC for 1 minute or 360V AC for 1s			250V AC for 1 minute or 300V AC for 2s	50V AC for 1 minute or 60V AC for 2s	300V AC for 1 minute or 360V AC for 2s		
Mechanical performance		Rotational torque (Without detent)		3 to 30mN·m		—		—	—	7mN·m max.			
		Detent torque		—		12±5mN·m		12±5mN·m (Initial) 10±4mN·m (After reflow)		10±5mN·m	40±20mN·m	8±5mN·m	
		Push-pull strength		100N									
Shaft configuration		Flat, Slotted, Serrated						Flat					
Terminal type		Insertion				Reflow		Insertion					
Switch Specifications		Switch type		Push-on switch									
		Contact arrangement		Single pole and single throw (Push-on)									
		Travel (mm)		0.5±0.3		1.5±0.5		0.5±0.3		1.5±0.5	0.5 ± _{0.2} ^{0.3}	1.5±0.5	0.5 ± _{0.3} ^{0.4}
		Operating force (N)		6 ± ₂ ²⁵		4±2		5±2		4±2	5±2	4±2	6±3
		Rating		0.1A 5V DC (500μA 5V DC min. ratings)		0.1A 5V DC (0.1mA 5V DC min. ratings)			5mA 5V DC (50mA 12V DC max. ratings)	0.5A 16V DC (1mA 16V DC min. ratings)	3A 16V DC (10mA 16V DC min. ratings)		
		Contact resistance		100mΩ max. for initial period, 200mΩ max. after operating life.						500mΩ max. for initial period, 5mΩ max. after operating life.	100mΩ max. for initial period, 200mΩ max. after operating life.		
		Operating life		20,000 times		1,000,000 times	100,000 times	1,000,000 times	100,000 times	1,000,000 times	20,000 times	25,000 times	
Page		276						286	288	291			

Encoders Soldering Conditions	315
Encoders Cautions	316

Note

● Indicates applicability to all products in the series.

Reference for Manual Soldering

Series	Tip temperature	Soldering time	No. of solders
EC05E, EC09E, EC10E, EC111, EC11B, EC11E, EC11G, EC11K, EC12D, EC12E, EC18A, EC21A, EC28A, EC35A, EC35AH, EC35B, EC40A, EC45A, EC50A, EC60B, EM11B, EM20B, EC21C, EC28C, EC35CH	350°C max.	3s max.	1 time
EC11J	350±10°C	3 ⁺¹ ₀ s	2 times

Reference for Dip Soldering

Series	Preheating		Dip soldering		No. of solders
	Soldering surface temperature	Heating time	Soldering temperature	Soldering time	
EC09E, EC11B, EC111, EC11E, EC11G, EC11K, EC18A, EC21A, EC28A, EC35A, EC35AH, EC35B, EC50A, EC60B	100°C max.	2 min. max.	260±5°C	5±1s	2 times max.
EC10E, EC12D, EC12E, EM11B	100°C max.	1 min. max.	260±5°C	3±1s	2 times max.
EC40A	110°C max.	1 min. max.	260°C max.	10s max.	1 time
EC45A	100°C max.	2 min. max.	260°C max.	5s max.	2 times max.
EM20B	80°C max.	1 min. max.	260°C max.	3s max.	2 times max.

Example of Reflow Soldering Condition

Temperature profile

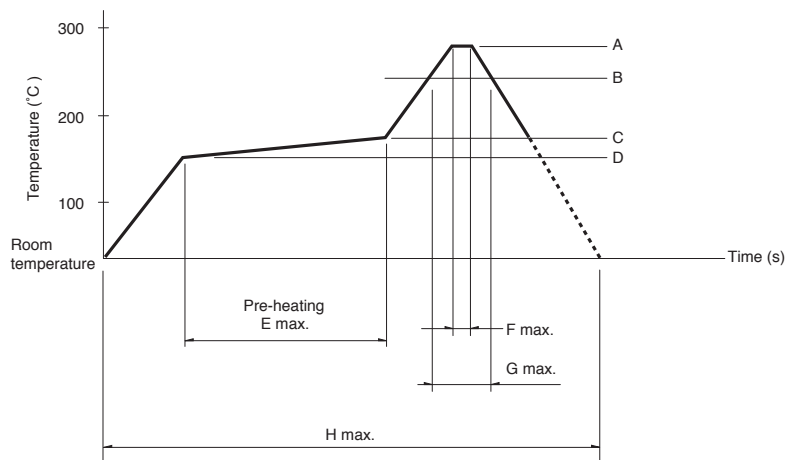

Series	A	B	C	D	E	F	G	H	No. of reflows
EC11J	260°C	230°C	180°C	150°C	2 min. max.	3s	40s	4 min. max.	2 times max.
EC05E	250°C min.	230°C min.	180°C	150°C	60s to 120s	—	30s to 40s	—	2 times max.
EC21C	230°C to 245°C	220°C	200°C	150°C	60s to 120s	—	25s to 60s	300s max.	1 time max.
EC28C, EC35CH	260°C	230°C	180°C	150°C	2 min. min.	3s	40s	230s max.	1 time max.

注記

- When using an infrared reflow oven, solder may sometimes not be applied. Be sure to use a hot air reflow oven or a type that uses infrared rays in combination with hot air.
- The temperatures given above are the maximum temperatures at the terminals of the encoder when employing a hot air reflow method. The temperature of the PC board and the surface temperature of the encoder may vary greatly depending on the PC board material, its size and thickness. Ensure that the surface temperature of the encoder does not rise to 250°C or greater.
- Conditions vary to some extent depending on the type of reflow bath used. Be sure to give due consideration to this prior to use.