

SX8663 Evaluation Kit

User's Guide

Table of Contents

1	Introduction.....	5
2	Getting Started.....	6
2.1	<i>Kit Contents.....</i>	6
2.2	<i>Installation/Quick Start.....</i>	7
2.3	<i>Other Demos.....</i>	9
2.4	<i>GUI Tooltips.....</i>	10
3	Hardware Description.....	11
3.1	<i>Overview.....</i>	11
3.1.1	USB Connector (#1).....	11
3.1.2	VREG (#2).....	11
3.1.3	EEPROM (#3).....	11
3.1.4	ON/OFF switch (#4).....	11
3.1.5	Application Jumpers (#5).....	12
3.1.6	Power Indication LED (#6).....	12
3.1.7	FT2232D (#7).....	12
3.1.8	Stand-alone Jumpers (#8).....	12
3.1.9	Header (#9).....	12
3.1.10	SX8663 (#10).....	13
3.1.11	Sensors and LEDs (#11).....	13
4	Guided Tour of the GUI/EVK.....	14
4.1	<i>Introduction.....</i>	14
4.2	<i>Operation Modes.....</i>	14
4.3	<i>LEDs Behavior.....</i>	14
4.4	<i>Capacitive Sensors.....</i>	15
5	GUI Description.....	17
5.1	<i>GUI Overview.....</i>	17
5.2	<i>File Menu.....</i>	17
5.2.1	Connect/Disconnect.....	17
5.2.2	Open SPM.....	18
5.2.3	Save SPM.....	18
5.2.4	Save SPM As.....	18
5.2.5	Exit.....	19
5.3	<i>Action Menu.....</i>	19
5.3.1	Refresh.....	19
5.3.2	Compensate Offset.....	19
5.3.3	Operating Mode.....	19
5.3.4	NVM Burn.....	19
5.4	<i>Help Menu.....</i>	20
5.4.1	Overview.....	20
5.4.2	Help.....	20
5.4.3	User's Guide.....	20
5.4.4	About SX8663 Evaluation Kit.....	21
5.5	<i>Toolbar.....</i>	22
5.6	<i>Status Bar.....</i>	23
5.7	<i>Sensor Status.....</i>	24
5.8	<i>GUI Tabs.....</i>	27
5.8.1	General Tab.....	27
5.8.2	Cap Sensors Tab.....	28
5.8.3	Buttons Tab.....	33

ADVANCED COMMUNICATIONS & SENSING

5.8.4	Proximity Tab.....	34
5.8.5	Buzzer Tab.....	35
5.8.6	GPIO Tab.....	36
5.8.7	SPM/I2C Tab.....	37
6	Schematics.....	39
7	Layout.....	41
8	References.....	43

Table of Figures

Figure 1: SX8663 Typical Application	5
Figure 2: EVK Contents.....	6
Figure 3: EVK Startup.....	7
Figure 4: EVK GUI Window	8
Figure 5: Button MK1 Touched.....	8
Figure 6: Tooltip Example.....	10
Figure 7: SX8663EVK Board Picture	11
Figure 8: Stand-alone Jumpers.....	12
Figure 9: Header	13
Figure 10: Operating Modes	14
Figure 11: GPIO Tab Modified.....	15
Figure 12: MK/Default Configuration.....	16
Figure 13: MK+PS Configuration	16
Figure 19: SX8663 GUI Overview.....	17
Figure 20: File Menu	17
Figure 21: SPM File Example (begin)	18
Figure 22: SPM File Example (end).....	18
Figure 23: Action Menu	19
Figure 24: Operating Mode.....	19
Figure 25: Confirm NVM Burn.....	20
Figure 26: Confirmation NVM is burned.....	20
Figure 27: GUI Help Menu.....	20
Figure 28: About Window	21
Figure 29: Toolbar.....	22
Figure 30: I2C Address.....	22
Figure 31: Status Bar.....	23
Figure 32: Status Bar with Error Message.....	23
Figure 33: Status Bar with SPM File	23
Figure 34: Sensor Status for SX8663 (both PS and PK Enabled).....	24
Figure 35: Example Proximity Detected and MK15 Touched.....	25
Figure 36: Sensor status for SX8663 (both PS and PK disabled)	26
Figure 37: General Tab	27
Figure 38: Cap Sensors Tab.....	28
Figure 39: Monitor Enabled	28
Figure 40: Monitor Summary Window.....	29
Figure 41: Show/Hide Monitor Signals.....	29
Figure 42: Superposing Threshold and Hysteresis of CAP11	30
Figure 43: Graph Window.....	31
Figure 44: Monitor Advanced Window	32
Figure 45: Buttons Tab.....	33
Figure 46: Proximity Tab	34
Figure 47: Buzzer Tab.....	35
Figure 48: GPIO Tab.....	36
Figure 49: SPM/I2C Tab.....	37
Figure 50: SPM Expanding General.....	38
Figure 51: SX8663EVK Schematics (1/2)	39
Figure 52: SX8663EVK Schematics (2/2)	40
Figure 53: SX8663EVK Top layer.....	41
Figure 54: SX8663EVK Mid Layer 1	41
Figure 55: SX8663EVK Mid Layer 2	42
Figure 56: SX8663EVK Bottom Layer.....	42

1 Introduction

The SX8663 Evaluation Kit enables the evaluation of the SX8662 and SX8663; Semtech's Capacitive Button Matrix (up to 36) and Proximity Controllers with Individual LED Drivers and Buzzer Output

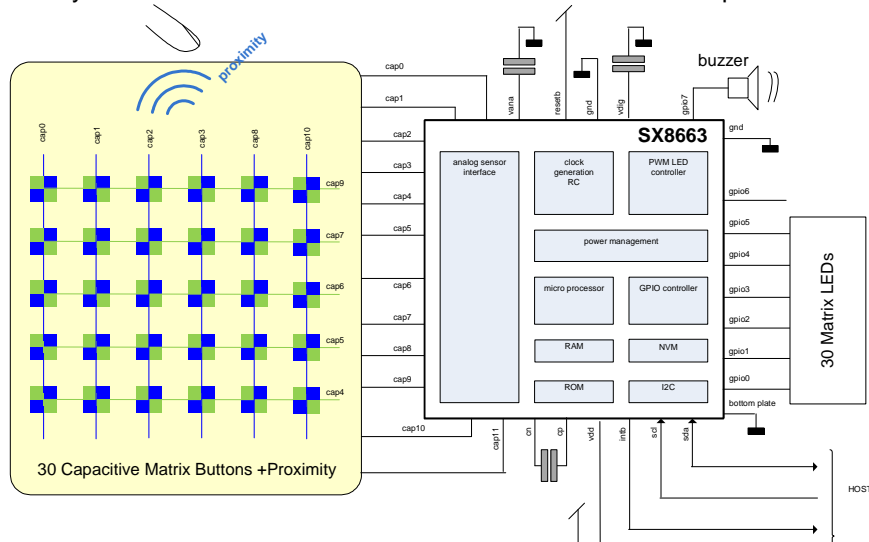


Figure 1: SX8663 Typical Application

SX8662/3 main features include:

- ◆ Complete Capacitive Touch-Button Solution
 - Up to 36 Matrix Buttons
 - Up to 36 LEDs Control for individual Visual Feedback with Auto Lightening
 - Configurable Single or Continuous Fading Mode
 - 256 steps PWM Linear and Logarithmic control
- ◆ Proximity Sensing up to several centimetres (SX8663)
- ◆ High Resolution Capacitive Sensing
 - Up to 100pF of Offset Cap. Compensation at Full Sensitivity
 - Capable of Sensing up thru 5mm thick Overlay Materials
- ◆ Support of buzzer for audible feedback
- ◆ User-selectable Button Reporting Configuration
- ◆ Extremely Low Power
 - 8uA (typ) in Sleep Mode
 - 100uA (typ) in Doze Mode (195ms)
 - 460uA (typ) in Active Mode (30ms)
- ◆ Programmable Scanning Period from 15ms to several seconds
- ◆ Auto Offset Compensation
 - Eliminates false triggers due to environmental factors (temperature, humidity)
 - Initiated on power-up and configurable intervals
- ◆ Multi-Time In-Field Programmable Firmware Parameters for Ultimate Flexibility
 - On-chip user programmable memory for fast, self contained start-up
- ◆ No External Components per Sensor Input
- ◆ Internal Clock Requires No External Components
- ◆ 400 KHz I²C Interface with Programmable Address

2 Getting Started

2.1 Kit Contents

As illustrated in the figure below, the Evaluation kit is composed of:

- SX8663EVK board with 2mm acrylic glass overlay.
- CDROM including all necessary PC software and documentation (requires min. Windows XP)
- Mini USB cable to connect the SX8663EVK board to the PC

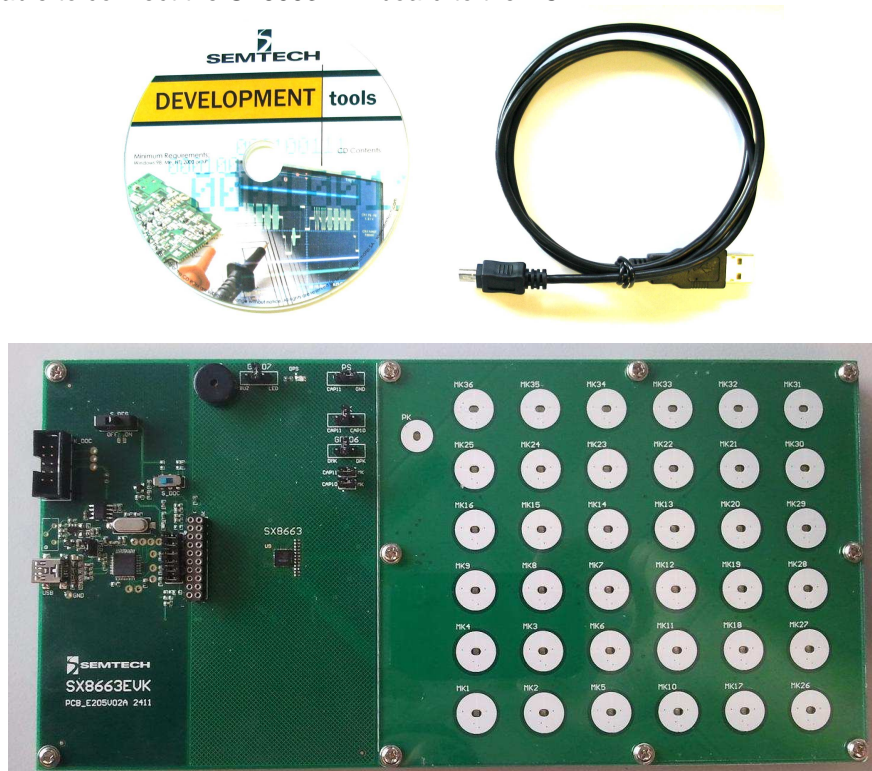


Figure 2: EVK Contents

2.2 Installation/Quick Start

- 1- Put the CDROM in your computer. If the installation does not start automatically, launch "SX8663EvaluationKitSetup.exe" manually.
- 2- Follow installation guidelines until the process is completed. Please note that .NET Framework 3.5 and the FTDI USB driver will be automatically downloaded and installed if not detected on your computer.
- 3- Set the ON/OFF switch (#4) to OFF (left position).
- 4- Connect the EVK board to the PC with the mini USB cable to connector #1.

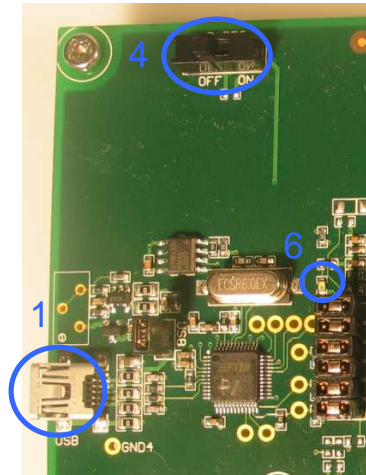



Figure 3: EVK Startup

- 5- The PC will recognize the EVK.
- 6- Set the ON/OFF switch (#4) to ON (right position).
- 7- The red LED (#6) will light up

The EVK is now ready to be used in stand-alone demo mode (without GUI).

By default the chip is configured for 6x6 button matrix operation; touching any matrix button (MKx) will turn ON its corresponding green LED (DMKx) while when the button is released the LED with fade OFF.

For more detailed evaluation and changing the default configuration of the EVK the GUI needs to be started.

- 8- Launch "SX8663EVK" from PC Start menu.
- 9- The EVK will be connected automatically and the following window will appear.
(In case the auto connect did not succeed: Click on "Disconnect/Connect" button  in toolbar or select 'Connect' in File menu)

ADVANCED COMMUNICATIONS & SENSING

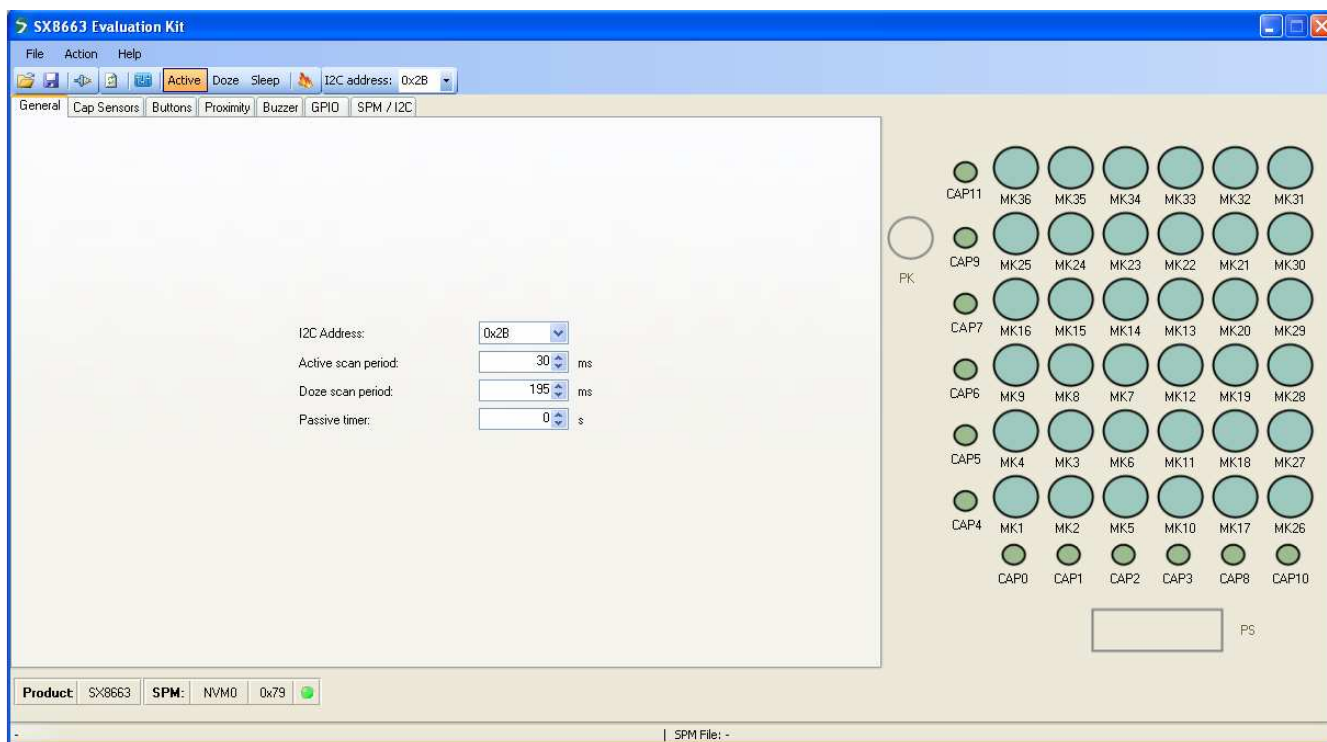


Figure 4: EVK GUI Window

The product 'SX8663' is shown in the left bottom corner of the GUI.

- 10- Touch with your finger any matrix button (e.g. MK1) on the EVK and the GUI shows MK1 is touched (white). DMK11 on the EVK will be turned on to the maximum intensity.

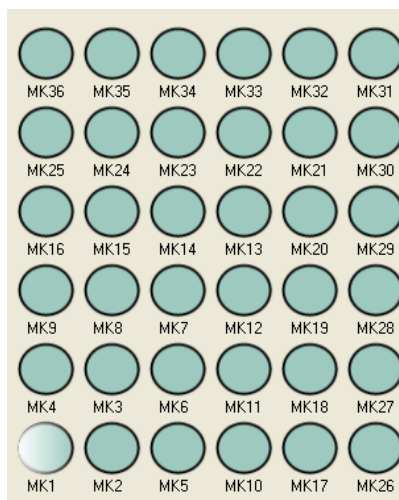


Figure 5: Button MK1 Touched

The EVK and GUI are now operational.

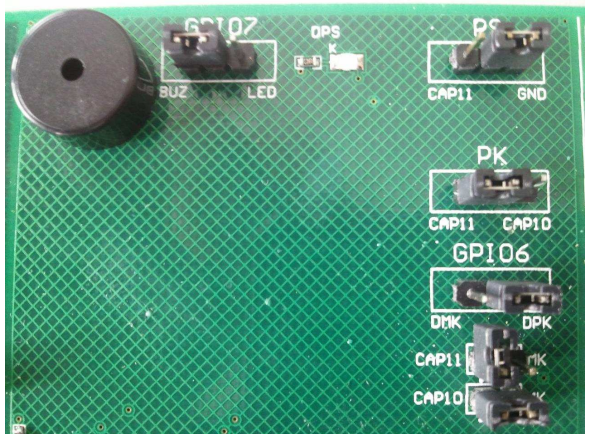
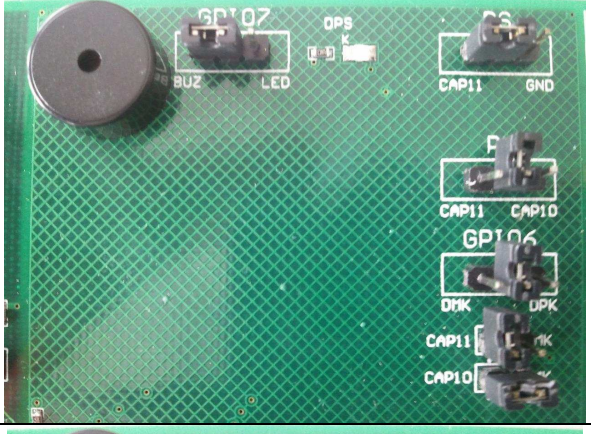
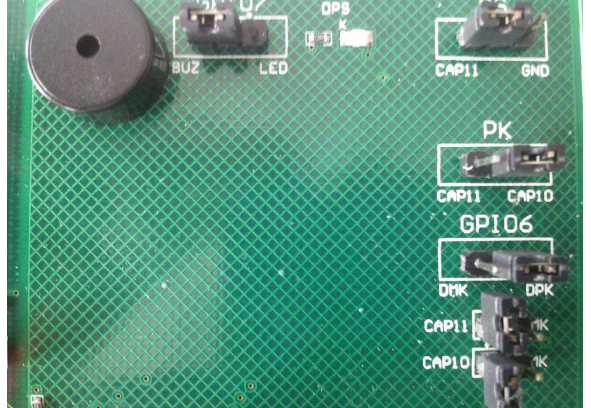
2.3 Other Demos

By default the EVK is preconfigured for a 6x6 matrix button demo (MK only).

The CD contains spm files which allow to quickly demonstrate/evaluate the three other possible sensors configurations: MK+PK; MK+PS; MK+PK+PS.

Assuming both EVK and GUI are operational/connected steps below must be performed:

- a) Set the application jumpers according to the desired configuration :

	Application jumpers (list)	Application jumpers (picture)
MK+PK	<ul style="list-style-type: none"> - PS = GND (right) - PK = CAP11 (left) - GPIO6 = DPK (right) - CAP11->MK = Open - CAP10->MK = ON - GPIO7 = BUZ (left) or Open 	
MK+PS	<ul style="list-style-type: none"> - PS = CAP11 (left) - PK = Open - GPIO6 = Open - CAP11->MK = Open - CAP10->MK = ON - GPIO7 = BUZ (left) or Open 	
MK+PK+PS	<ul style="list-style-type: none"> - PS = CAP11 (left) - PK = CAP10 (right) - GPIO6 = DPK (right) - CAP11->MK = Open - CAP10->MK = Open - GPIO7 = BUZ (left) or Open 	

b) In the GUI go to File->Open SPM... and open the file corresponding to the desired configuration :

- SX8663_MK.spm
- SX8663_MK_PK.spm
- SX8663_MK_PS_PK.spm

c) In the GUI go to Action->Compensate Offset

The EVK is now ready to be used in the new configuration.

Please note that in MK+PK+PS configuration MK26-30 are not active (Cf GUI) but their LEDs are still connected and hence indirectly controlled by the TSM matrix. Please ignore their states since in a real MK+PS+PK application these LEDs wouldn't exist.

2.4 GUI Tooltips

All GUI buttons, LEDs, scroll bars, icons have tooltips which explain briefly the functionality. The tooltips can be activated by the user by moving the mouse over the desired area (see example I2C address selection).

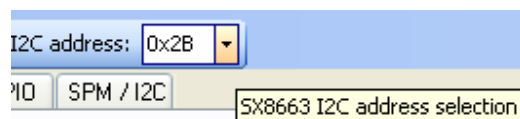


Figure 6: Tooltip Example

3 Hardware Description

The EVK board is described in this chapter. Please refer to the schematics and layout provided at the end of the document for more details about the exact hardware implementation.

3.1 Overview

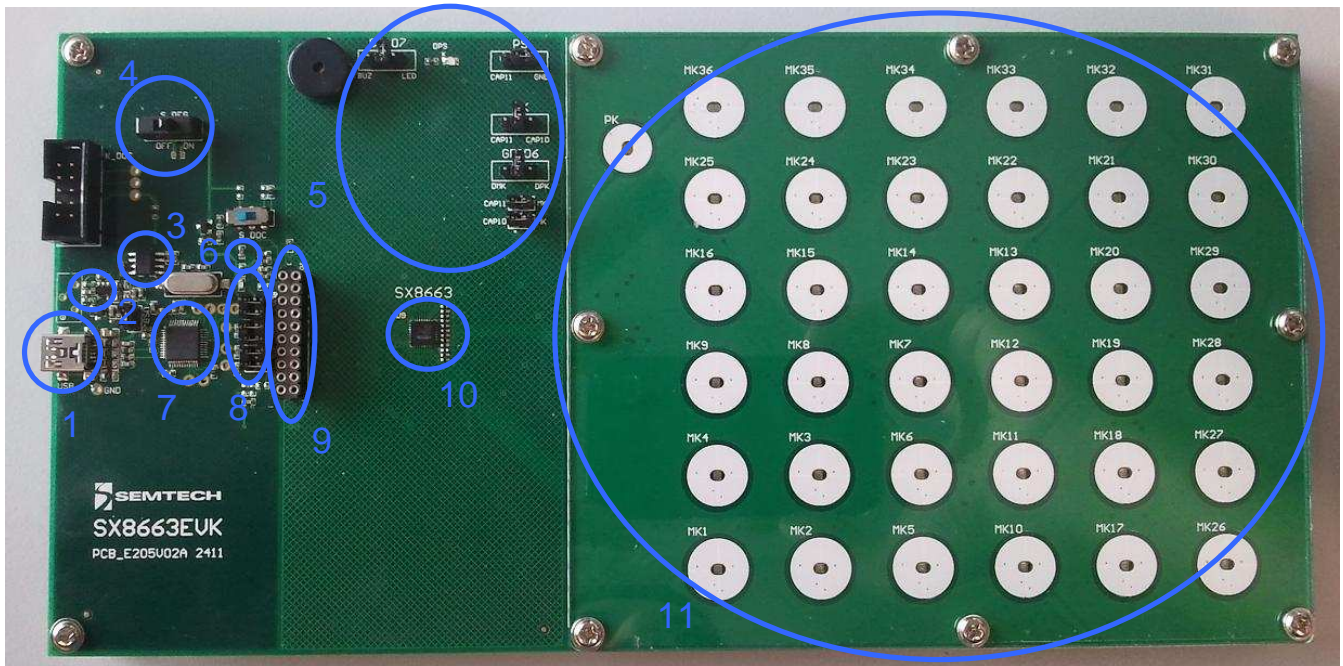


Figure 7: SX8663EVK Board Picture

3.1.1 USB Connector (#1)

The USB connector allows the EVK to be connected to a PC from which it will get its power and configuration/control commands via the dedicated software.

3.1.2 VREG (#2)

VREG is fixed to the typical operating voltage of 3.3V using the Semtech SC153 voltage regulator, ensuring correct I2C communication between the SX8663 and the FT2232D.

3.1.3 EEPROM (#3)

FT2232D is associated to an EEPROM which keeps the FTDI chip's parameters when power is turned off. The EEPROM is used to customize USB device description.

3.1.4 ON/OFF switch (#4)

The ON/OFF switch turns ON (right position) or OFF (left position) the supply for the SX8663 and at the same time the red power indication LED (#6).

ADVANCED COMMUNICATIONS & SENSING

3.1.5 Application Jumpers (#5)

The application jumpers are meant to adapt the physical connection of the sensors and GPIOs to the actual configuration programmed inside the chip

Default positions of application jumpers (6x6 button matrix with tri-state multiplexing):

- The PS jumper is in GND position (right)
- The PK jumper is open
- The GPIO6 jumper is in DMK position (left)
- The two lower jumpers (CAP11->MK; CAP10->MK) are ON.
- The GPIO7 jumper is open

3.1.6 Power Indication LED (#6)

The read LED indicates if the SX8663 is turned ON or OFF, according the position of switch (#4).

3.1.7 FT2232D (#7)

The FT2232D from FTDI will be used as a USB to I2C bridge between the PC and the SX8663; moreover it will also monitor and control RESETB and INTB signals (similar to what a host would do in a final application). The USB bridge is supplied directly over the USB cable.

3.1.8 Stand-alone Jumpers (#8)

These six jumpers are connecting the FT2232D bridge to the SX8663.

Their purpose is, as their name suggests, being able to disconnect the SX8663 from the rest of the circuitry to access it externally (with an external host, sharing another I2C bus, etc.).



Figure 8: Stand-alone Jumpers

3.1.9 Header (#9)

The header, 2x10 pins, allows the user connect to the different signals on the board e.g. for monitoring purposes.

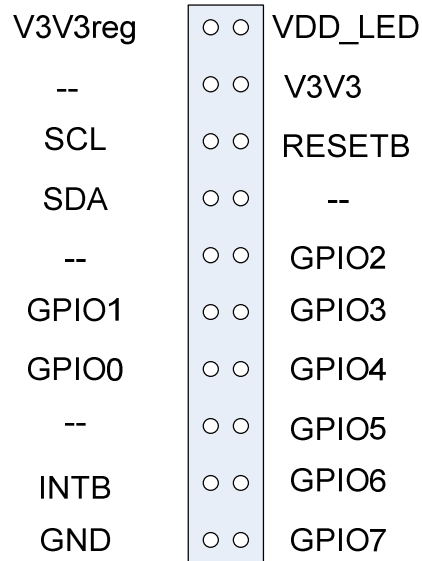


Figure 9: Header

3.1.10 SX8663 (#10)

The Semtech Capacitive Touch and Proximity Controller.

3.1.11 Sensors and LEDs (#11)

This section implements all the possible sensors (36 matrix buttons, 1 priority button and 1 proximity sensor) as well as one individual LED per button

4 Guided Tour of the GUI/EVK

4.1 Introduction

This section allows the user to get to know the basics of the SX8663 and its evaluation kit. More technical details are given in following chapters and in the product datasheet (reference [1]).

The steps in this chapter are straight forward and do not require a very detailed knowledge of the SX8663 neither of the EVK.

4.2 Operation Modes

Directly after a power up of the EVK the SX8663 will enter Active mode and sensor pins will be sensed every 30ms. The user can change the operation mode by clicking on the icons. The actual operation mode is then highlighted as shown below.

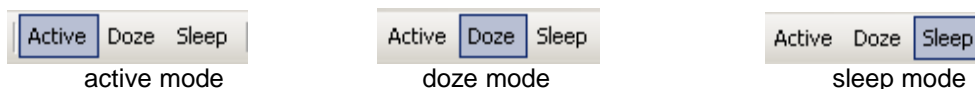


Figure 10: Operating Modes

The sensor pins are sensed every 195 ms in Doze Mode.
The sensor pins are not sensed at all in Sleep Mode.
There are 2 ways to change manually operating mode:
1) Using the Toolbar buttons
2) Using the Action menu

4.3 LEDs Behavior

Touching MK1 will change the LED DMK1 intensity on the EVK from OFF to maximum intensity. When MK1 is released the LED will slowly fade out until it's OFF.

DMK1 is driven using Triple State Multiplexing (TSM) technique so in order to change its behavior we first need to identify which GPIO drives it. Cf. EVK schematics DMK1 is connected between GPIO1 (anode) and GPIO0 (cathode) so to change its behavior we need to modify GPIO1 parameters.

Please note that in the TSM matrix each GPIO drives up to 6 LEDs so all of them will have the same behavior.

In the GPIO tab Dec time of column IO1 can be changed from 2ms (default) to OFF for example.

ADVANCED COMMUNICATIONS & SENSING

		I07	I06	I05	I04	I03	I02	I01	I00
SPM	Mode:	BUZ	GPO	GPO	GPO	GPO	GPO	GPO	GPO
	State after powerup:	OFF	OFF	OFF	OFF	OFF	OFF	OFF	OFF
	Autolight:	ON	ON	ON	ON	ON	ON	ON	ON
	Polarity:	Inverted	Normal	Normal	Normal	Normal	Normal	Normal	Normal
	ON intensity:	255	255	255	255	255	255	255	255
	OFF intensity:	0	0	0	0	0	0	0	0
	Function:	Log	Log	Log	Log	Log	Log	Log	Log
	Inc factor:	1	1	1	1	1	1	1	1
	Dec factor:	1	1	1	1	1	1	1	1
	Inc time:	OFF	OFF	OFF	OFF	OFF	OFF	OFF	OFF
	Dec time:	2.0 ms	2.0 ms	2.0 ms	2.0 ms	2.0 ms	2.0 ms	OFF	2.0 ms
	OFF delay:	OFF	OFF	OFF	OFF	OFF	OFF	OFF	OFF
	Pullup/Pulldown:	Disabled	Disabled	Disabled	Disabled	Disabled	Disabled	Disabled	Disabled
	--	None	None	None	None	None	None	None	None
	--	OFF	OFF	OFF	OFF	OFF	OFF	OFF	OFF
Fading Mode	Single	Single	Single	Single	Single	Single	Single	Single	
I2C	GPO control:	OFF	OFF	OFF	OFF	OFF	OFF	OFF	OFF
	GPP intensity:	0	0	0	0	0	0	0	0

Figure 11: GPIO Tab Modified

Each modification on this tab is immediately written to the EVK. After this is done, all the LEDs driven by GPIO1 (i.e. DMK1, DMK3, DMK11, DMK13 and DMK22) turn off directly after a release instead of fading out slowly.

4.4 Capacitive Sensors

The SX8663 starts up with 36 MK buttons (6x6 matrix) and no PK or PS. The right side of the GUI shows the current sensors configuration. Grey icons are disabled sensors/functions.

Important: For correct behavior the application jumpers on board must match the programmed MK/PK/PS configuration.

ADVANCED COMMUNICATIONS & SENSING

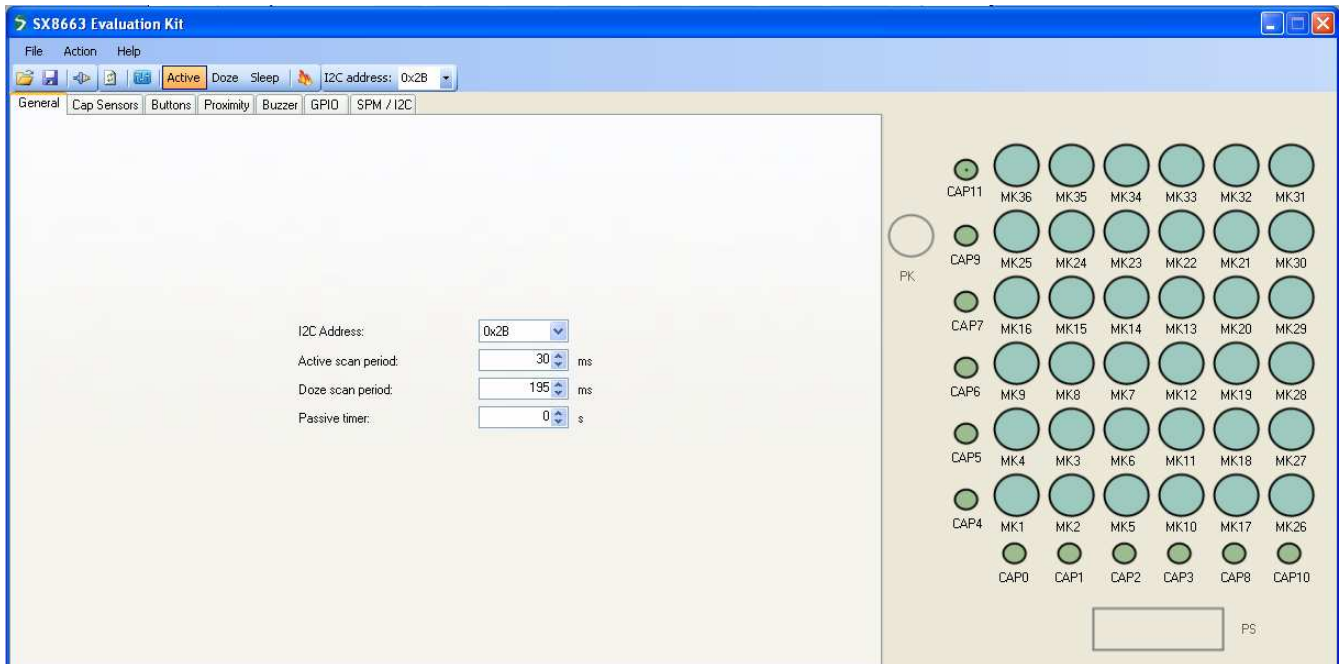


Figure 12: MK/Default Configuration

PK and PS can be enabled respectively in the “Buttons” and “Proximity” tabs. The screenshots below show a MK + PS configuration resulting from enabling proximity sensing in the relevant tab.

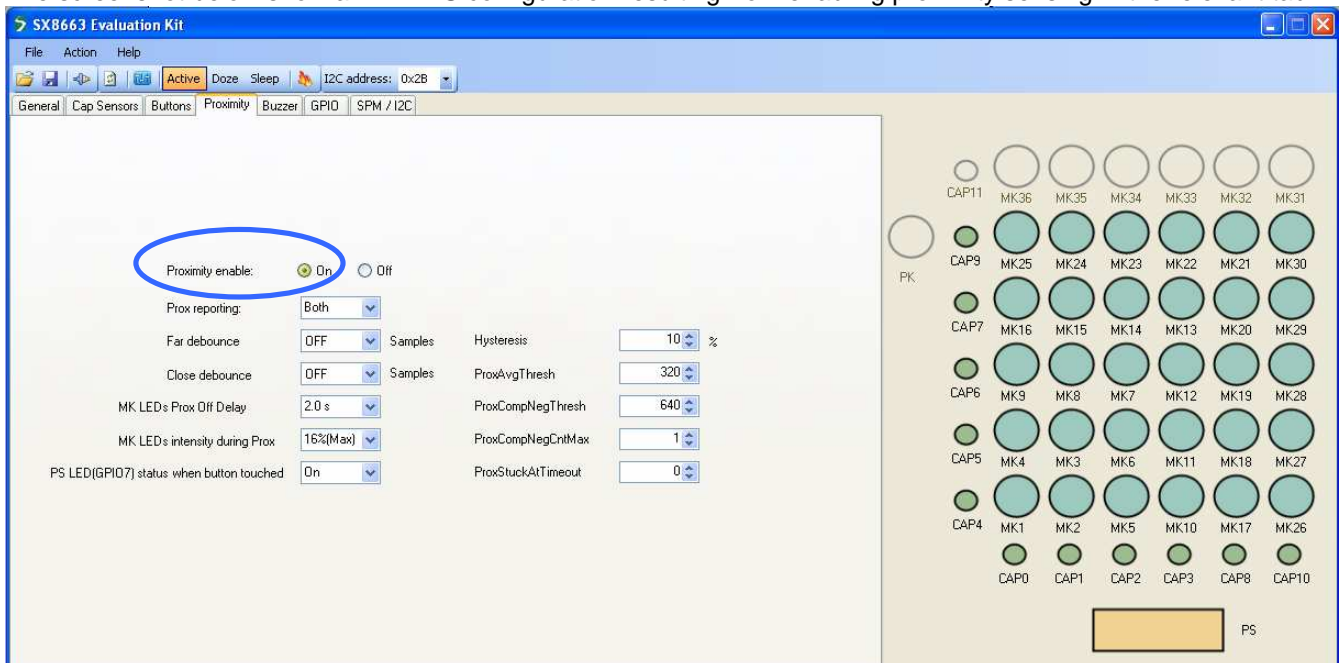


Figure 13: MK+PS Configuration

MK matrix is reduced to 5x6 since CAP11 is now allocated to proximity sensing.

5 GUI Description

5.1 GUI Overview

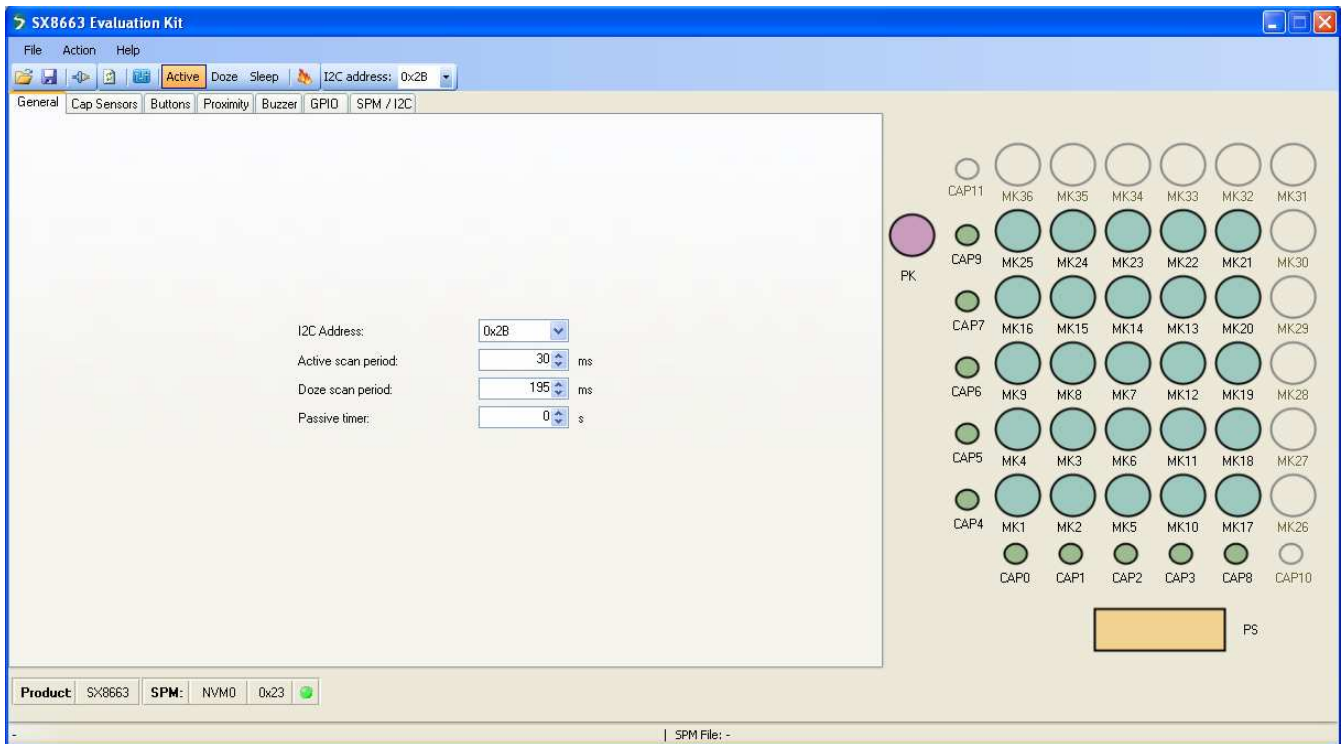


Figure 14: SX8663 GUI Overview

5.2 File Menu

File menu contains general purpose functions. Most of them can also be accessed on the toolbar by clicking directly on the icon.

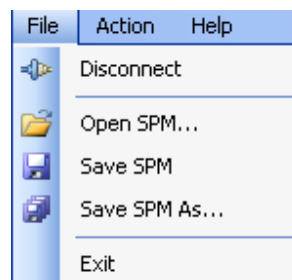



Figure 15: File Menu

5.2.1 Connect/Disconnect

This item is used to connect/disconnect the GUI to/from the EVK.


The icon and name of the menu item dynamically changes depending on the current connection state.

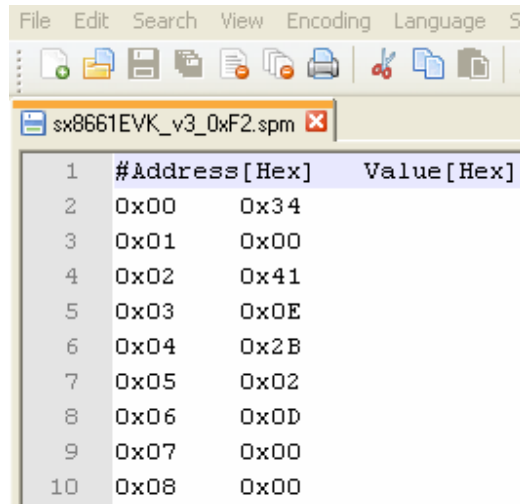
This feature is also available directly on the toolbar. 

5.2.2 Open SPM

The GUI offers the possibility to save/load the SPM parameters into/from a file.

The “Open SPM” feature reads a SPM file, stored on the PC, and copies the content to the SPM of the SX8663.

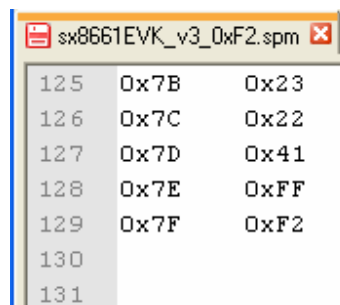
This feature is also available directly on the toolbar. 



	#Address [Hex]	Value [Hex]
1	0x00	0x34
2	0x01	0x00
3	0x02	0x41
4	0x03	0x0E
5	0x04	0x2B
6	0x05	0x02
7	0x06	0x0D
8	0x07	0x00
9	0x08	0x00
10	0x08	0x00

Figure 16: SPM File Example (begin)

The SPM files contain 128 data bytes for the address 0x00 to 0x7F. The end of the SPM file is shown below.




125	0x7B	0x23
126	0x7C	0x22
127	0x7D	0x41
128	0x7E	0xFF
129	0x7F	0xF2
130		
131		

Figure 17: SPM File Example (end)

5.2.3 Save SPM

This feature saves the current SPM from the SX8663 in the currently opened SPM file and overriding it (after confirmation by the user).

This feature is also available directly on the toolbar. 

5.2.4 Save SPM As

This is the standard derivate of the “Save SPM” feature used to save the current SPM to a different name.

ADVANCED COMMUNICATIONS & SENSING

5.2.5 Exit

This item closes the GUI.

5.3 Action Menu

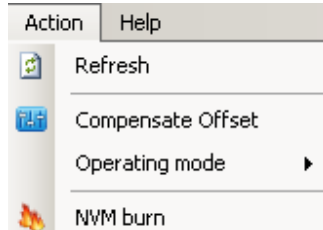



Figure 18: Action Menu

5.3.1 Refresh


This item is used to read values from the EVK to update the GUI in case these both are out of sync.

This feature is also available directly on the toolbar. 

5.3.2 Compensate Offset

This item is used to force a compensation of parasitic capacitances.

By clicking on the item the GUI issues the I2C command to start the compensating procedures in the SX8663. This

feature is also available directly on the toolbar. 

5.3.3 Operating Mode

This item is used to change the operating mode of the EVK.

This feature is also available directly on the toolbar.

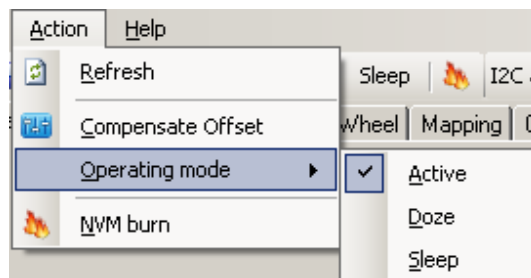



Figure 19: Operating Mode

5.3.4 NVM Burn

This item is used to write permanently the SPM content in the NVM.

This feature is also available directly on the toolbar. 

ADVANCED COMMUNICATIONS & SENSING

Important: The NVM can be burned three times only so the burn feature needs to be used with caution.

By selecting the item the user needs to confirm the NVM burn.
The burn is confirmed by entering the key "A55A" and by selecting the Yes button.

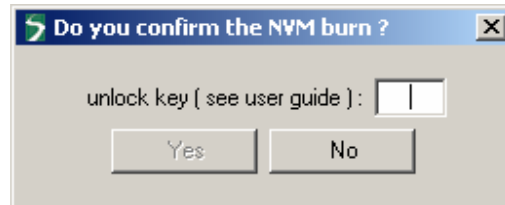


Figure 20: Confirm NVM Burn

After the NVM burn the GUI will inform the user the NVM burning is terminated.

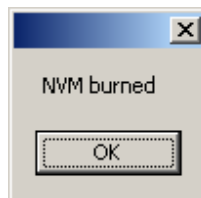


Figure 21: Confirmation NVM is burned

After a power down-power up sequence the EVK will start up with the new settings.

5.4 Help Menu

5.4.1 Overview

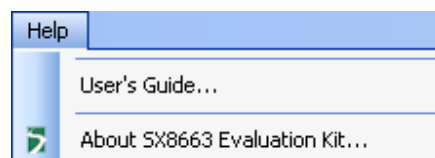


Figure 22: GUI Help Menu

5.4.2 Help

This item shows or hides the help window. The help window shows useful information when the user moves the mouse over GUI items, registers etc...

5.4.3 User's Guide

This item opens the User's guide (pdf).
The User's guide is found as well in the EVK installation directory.

5.4.4 About SX8663 Evaluation Kit

This item shows the versions of the GUI and SX8663.



Figure 23: About Window

5.5 Toolbar

The toolbar allows the user to choose rapidly an action without browsing through the file, action and help menu. The description of the items can be found in the previous menu sections.

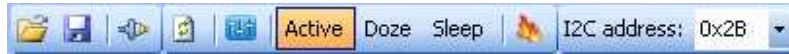


Figure 24: Toolbar

The I2C address is showing the address the GUI uses to communicate with the EVK (default address 0x2B). If a SX8663 with a different address is connected then the user can select the GUI address by typing directly the address value or by using the scroll bar.

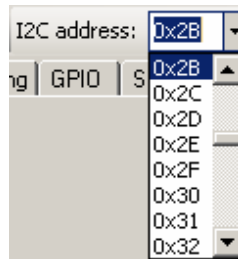


Figure 25: I2C Address

5.6 Status Bar

The status bar shows useful information on the status of the GUI and the EVK.

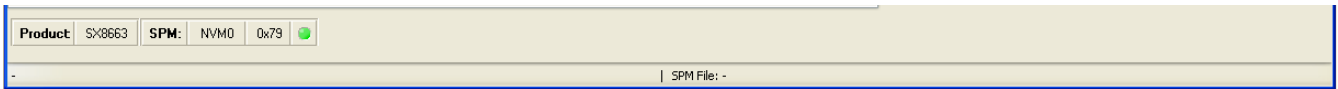



Figure 26: Status Bar

The **product** field shows the detected product on the EVK (SX8663).

The **SPM** field shows the origin of the SPM. This will be either QSM, NVM0, NVM1 or NVM2.

The last two fields show the CRC of the SPM calculated by the GUI and if that CRC corresponds to the CRC of the EVK.

A green LED shows both CRCs are identical.

An orange LED shows that the CRCs are different. Clicking the 'refresh'  item will synchronize the GUI and the EVK and the LED will turn green.

The fields at the bottom of the Status bar show error messages or the actual name of the used SPM file.

E.g. an error message will appear if the GUI tries to connect to an EVK which is not powered.

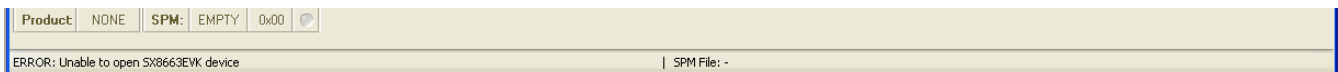


Figure 27: Status Bar with Error Message

In case the user opens or saves a SPM file then the current SPM file name appears at the right bottom side of the status bar.



Figure 28: Status Bar with SPM File

5.7 Sensor Status

The sensor status area shows MK, PK(if enabled) and PS(if enabled).



Figure 29: Sensor Status for SX8663 (both PS and PK Enabled)

The sensor status is taken from the I2C registers of the SX8663.

If a hand approaches the EVK the orange icon (PS) turns in to white.

If the user touches a button (MK or PK) then the GUI turns the corresponding button into white. Additionally when an MK button is touched its corresponding CAPx sensors also turn white.

ADVANCED COMMUNICATIONS & SENSING


Figure 30: Example Proximity Detected and MK15 Touched.

The GUI automatically displays MK/PK/PS according to the current configuration:

- When both PS and PK are OFF: PS and PK are greyed out
- When only PS is ON: PK, CAP11, and MK31-36 are greyed out
- When only PK is ON: PK, CAP11, and MK31-36 are greyed out
- When both PS and PK are ON: CAP11, CAP10 and MK26-36 are greyed out

Important: For correct behavior the application jumpers on board must match the programmed MK/PK/PS configuration.

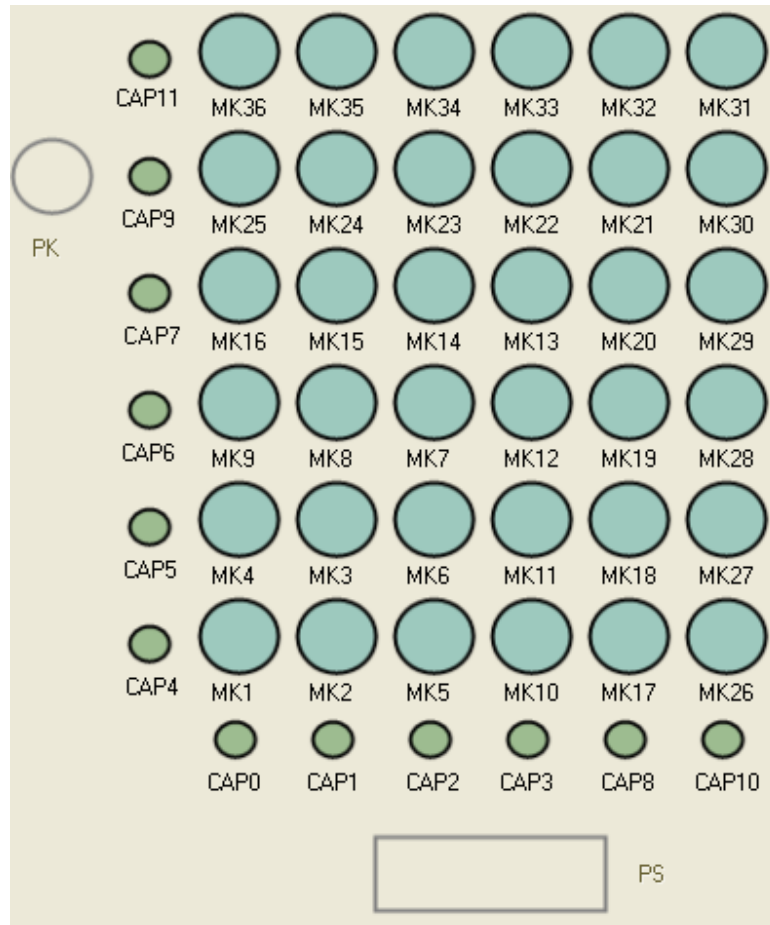
ADVANCED COMMUNICATIONS & SENSING


Figure 31: Sensor status for SX8663 (both PS and PK disabled)

5.8 GUI Tabs

The GUI uses seven tabs:

- General
- Cap Sensors
- Buttons
- Proximity
- Buzzer
- GPIO
- SPM/I2C

The content of the tabs allow the user to change the configuration of the SX8663.

The tabs are organized according to the sections of the SPM which are described in detail in the datasheet of the SX8663[1].

Each tab shows specific configuration data which can be changed by the user. The GUI assists the user by entering high level parameters so that it is not required to know the detailed hexadecimal information. Parameters will be greyed out if the user does not have to program them or if they do not apply.

In case the user prefers to enter direct hexadecimal data then this can be done in the SPM/I2C tab.

5.8.1 General Tab

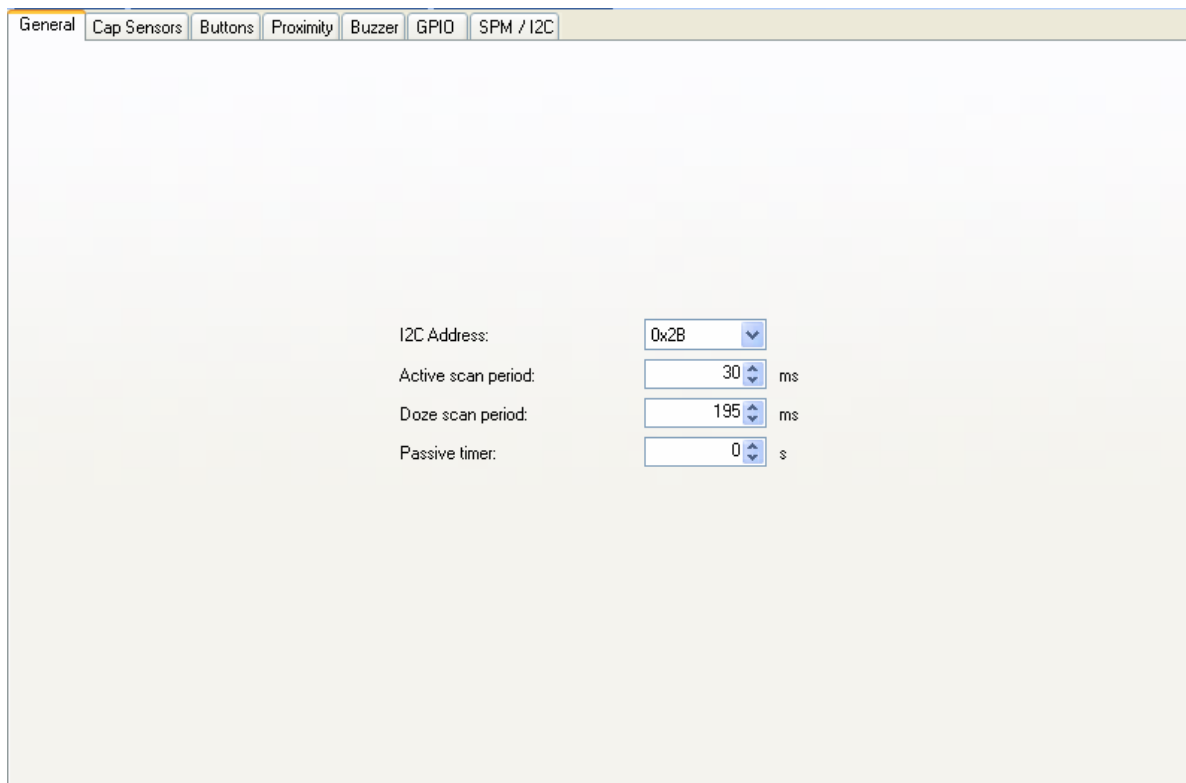
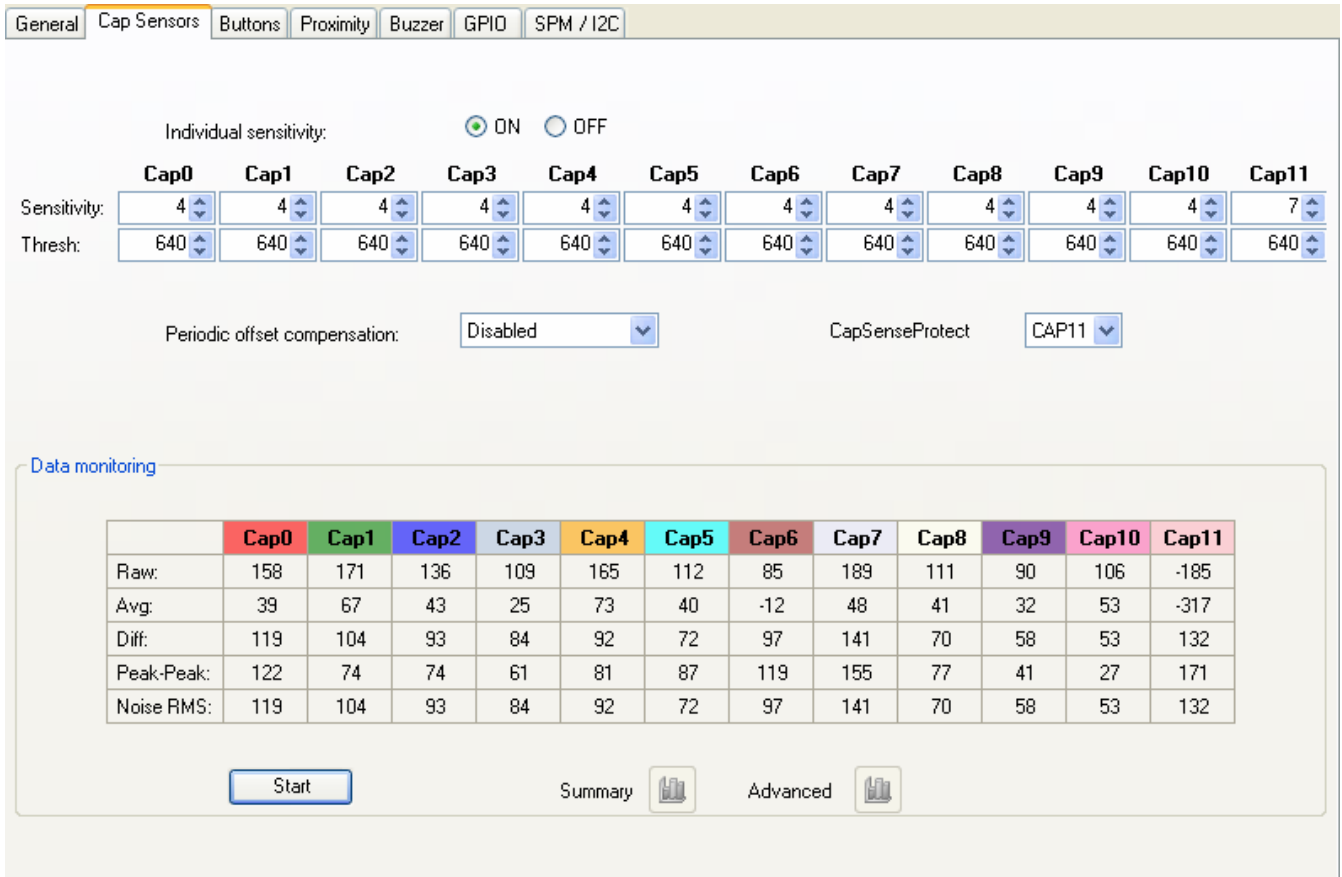


Figure 32: General Tab

The general tab allows the user to change general settings like I2C address or scan period.

ADVANCED COMMUNICATIONS & SENSING

5.8.2 Cap Sensors Tab



General **Cap Sensors** Buttons Proximity Buzzer GPIO SPM / I2C

Individual sensitivity: ON OFF

	Cap0	Cap1	Cap2	Cap3	Cap4	Cap5	Cap6	Cap7	Cap8	Cap9	Cap10	Cap11
Sensitivity:	4	4	4	4	4	4	4	4	4	4	4	7
Thresh:	640	640	640	640	640	640	640	640	640	640	640	640

Periodic offset compensation: Disabled
CapSenseProtect: CAP11

Data monitoring

	Cap0	Cap1	Cap2	Cap3	Cap4	Cap5	Cap6	Cap7	Cap8	Cap9	Cap10	Cap11
Raw:	158	171	136	109	165	112	85	189	111	90	106	-185
Avg:	39	67	43	25	73	40	-12	48	41	32	53	-317
Diff:	119	104	93	84	92	72	97	141	70	58	53	132
Peak-Peak:	122	74	74	61	81	87	119	155	77	41	27	171
Noise RMS:	119	104	93	84	92	72	97	141	70	58	53	132

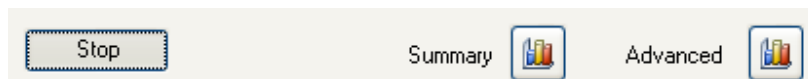
Start Summary Advanced

Figure 33: Cap Sensors Tab

The top of the cap sensor tab is dedicated to the parameters associated to the sensors pins CAP0 to CAP11 of the SX8663 (Sensitivity, Threshold, etc).

The bottom part of this tab allows the user to monitor the signals on each pin (Summary and/or Advanced). The monitor is enabled by clicking the 'Start' button.

The monitor icons will be enabled and the 'Start' button turns in to the 'Stop' button.



Stop Summary Advanced

Figure 34: Monitor Enabled

In monitor mode the capacitive sensors are scanned every 195ms as the data rate over the USB is increased.

By clicking on the monitor Summary icon the GUI opens the monitor summary window

ADVANCED COMMUNICATIONS & SENSING

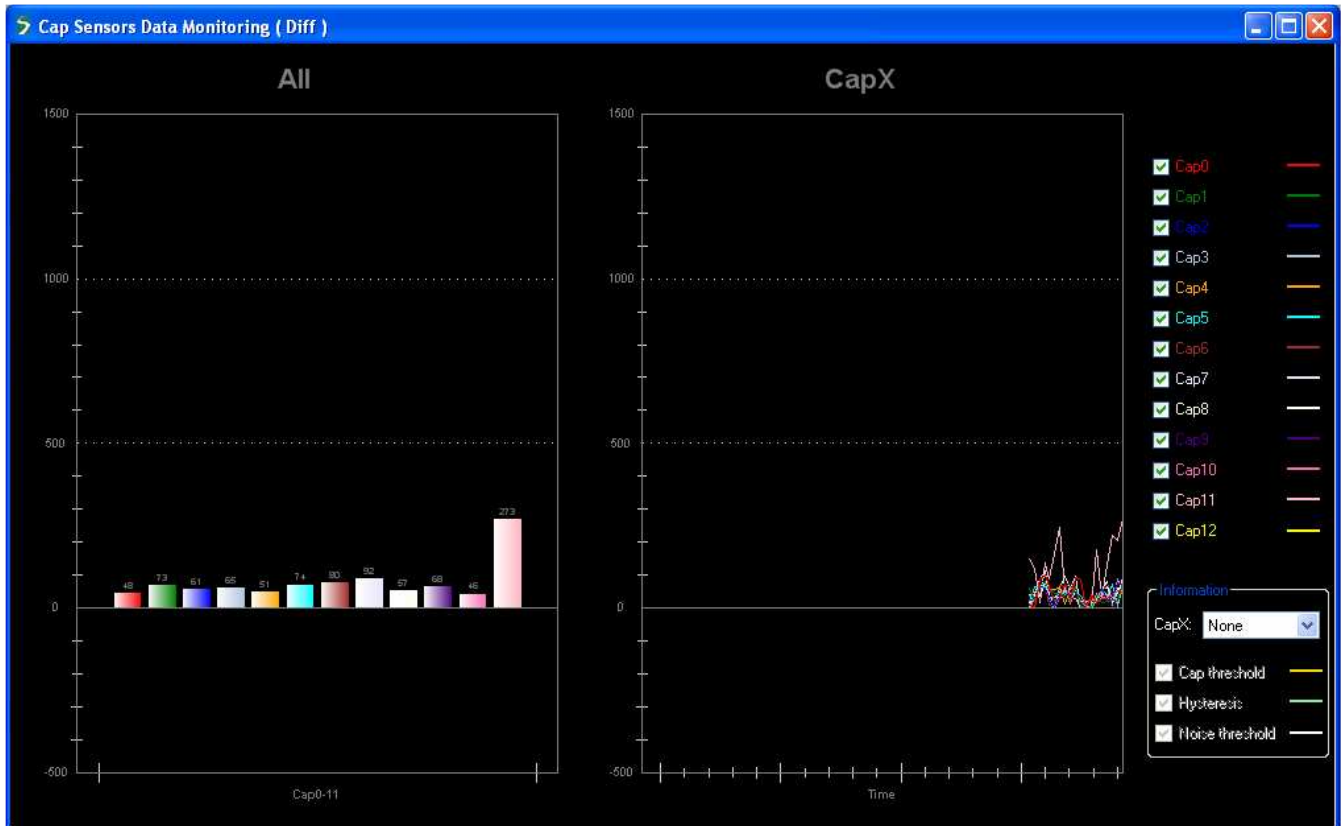


Figure 35: Monitor Summary Window

The monitor window shows the cap sensors (differential) data (see datasheet for details). The left side of the window (graph header 'All') shows the current value of all enabled cap sensors. The right side of the window (graph header 'CapX') shows the values of all enabled cap sensors over time.

User can also hide or show signals by checking the boxes next to the Cap text.

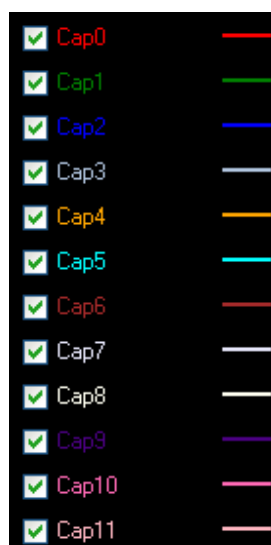


Figure 36: Show/Hide Monitor Signals

Thresholds of a specific sensor can also be superposed on the graphs.

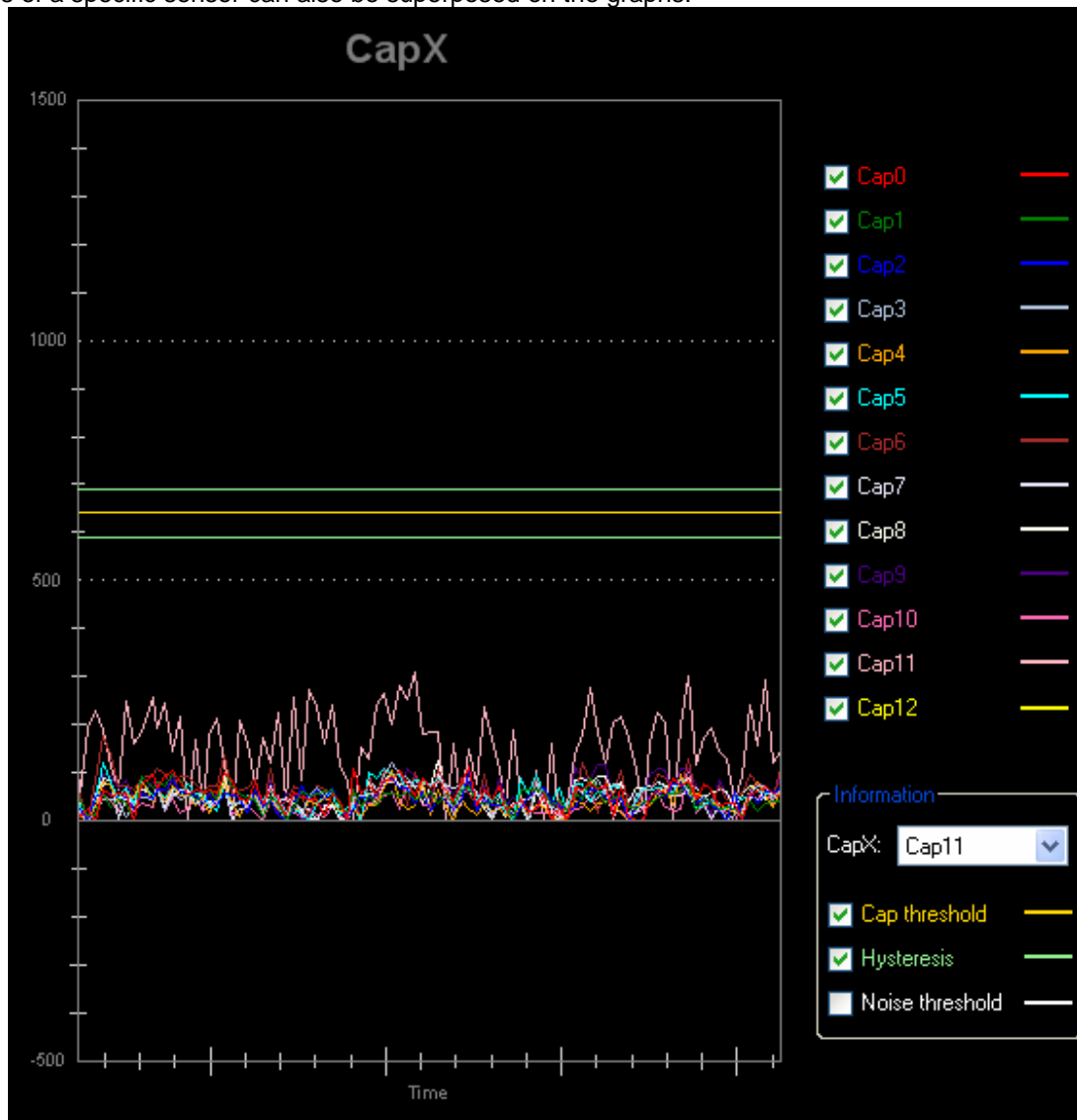


Figure 37: Superposing Threshold and Hysteresis of CAP11

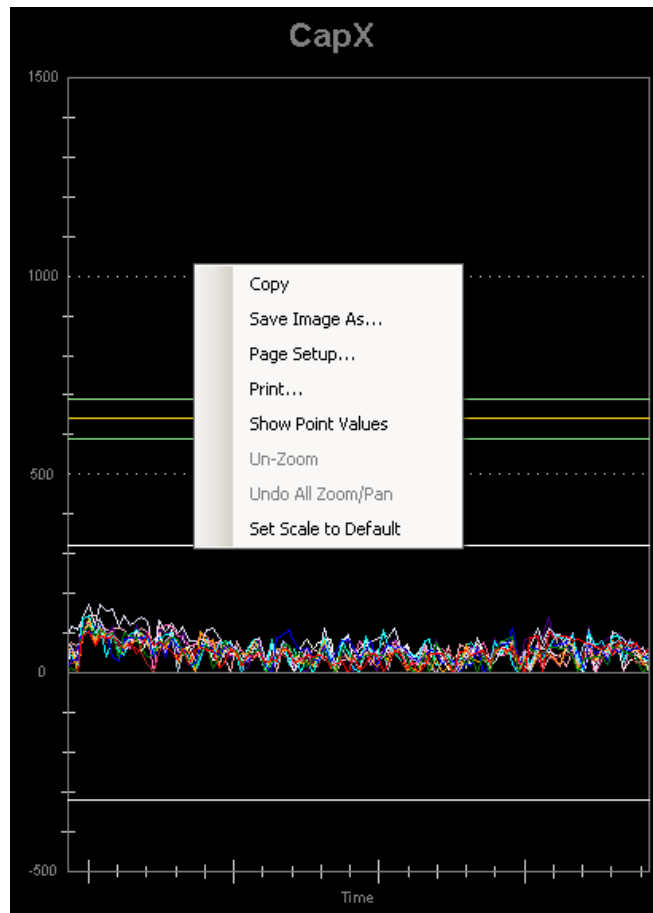


Figure 38: Graph Window

By a right button mouse click on the graph a pop up window appears which allows the user to copy, save and print the graph. Furthermore the user can zoom or un-zoom into specific graph regions of interest.

By clicking on the monitor Advanced icon the GUI opens the monitor Advanced window

ADVANCED COMMUNICATIONS & SENSING

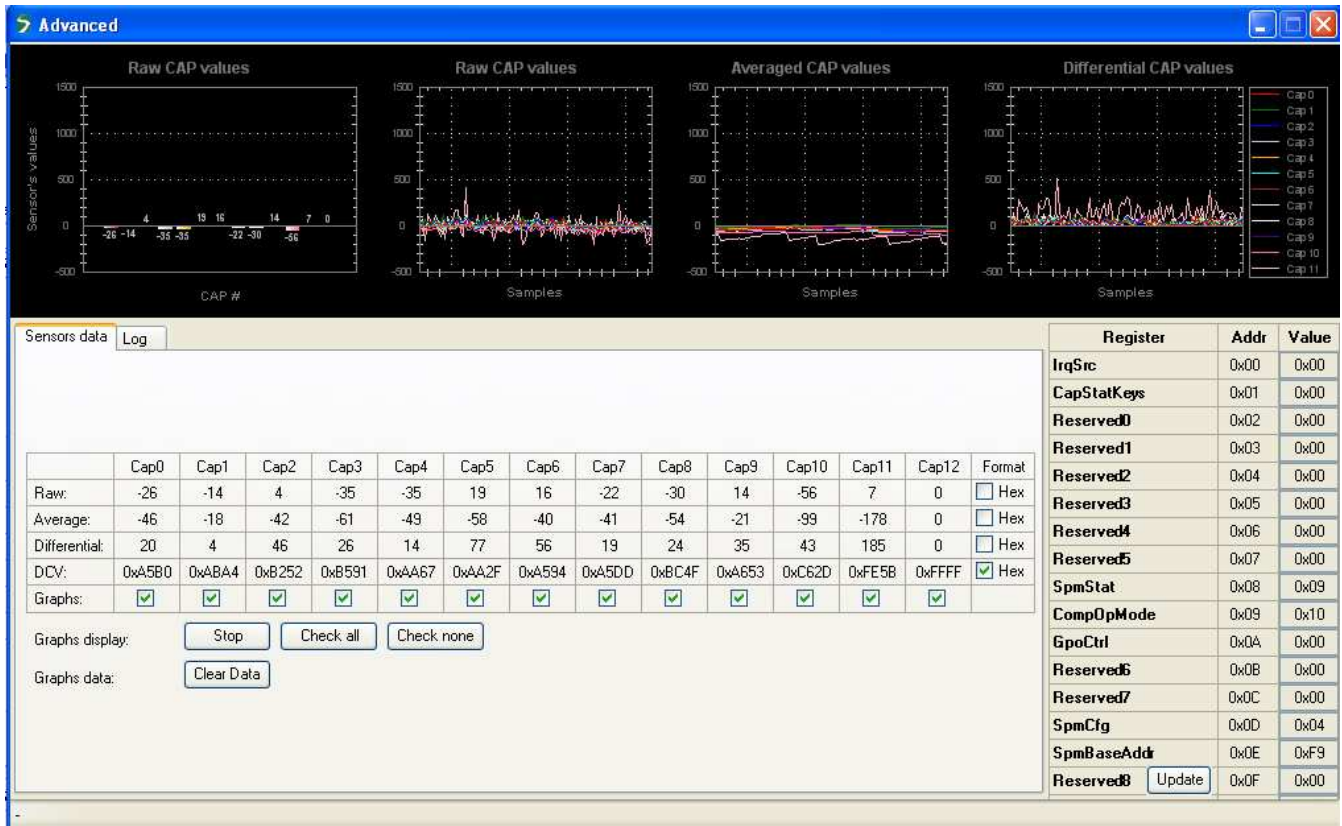


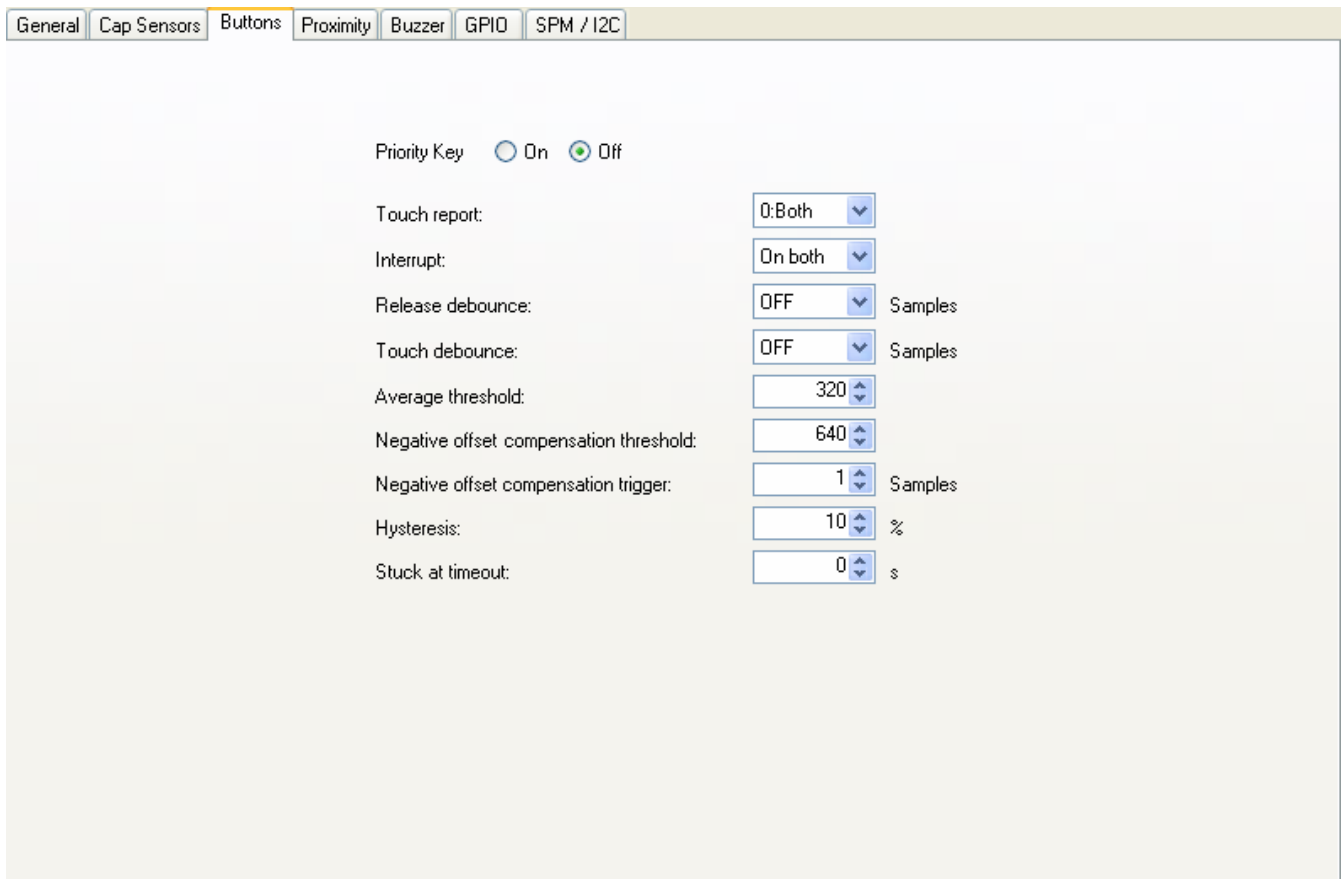
Figure 39: Monitor Advanced Window

The advanced window gives an overview of internal states of the SX8663. The datasheet describes the signals in the graphs (related to the analog sensing interface) in more details. DCV values are expected to be in the range of 0x5000 to 0xF000 for enabled sensors.

The monitor windows can be quit by clicking on the red cross on the right, top side of the windows.



5.8.3 Buttons Tab



General	Cap Sensors	Buttons	Proximity	Buzzer	GPIO	SPM / I2C
---------	-------------	---------	-----------	--------	------	-----------

Priority Key On Off

Touch report: 0:Both

Interrupt: On both

Release debounce: OFF Samples

Touch debounce: OFF Samples

Average threshold: 320

Negative offset compensation threshold: 640

Negative offset compensation trigger: 1 Samples

Hysteresis: 10 %

Stuck at timeout: 0 s

Figure 40: Buttons Tab

The buttons tab allows the user to change the configuration of the buttons.

5.8.4 Proximity Tab

General	Cap Sensors	Buttons	Proximity	Buzzer	GPIO	SPM / I2C
<p>Proximity enable: <input checked="" type="radio"/> On <input type="radio"/> Off</p> <p>Prox reporting: <input type="text" value="Both"/></p> <p>Far debounce: <input type="text" value="OFF"/> Samples Hysteresis: <input type="text" value="10"/> %</p> <p>Close debounce: <input type="text" value="OFF"/> Samples ProxAvgThresh: <input type="text" value="320"/></p> <p>MK LED's Prox Off Delay: <input type="text" value="2.0 s"/> ProxCompNegThresh: <input type="text" value="640"/></p> <p>MK LED's intensity during Prox: <input type="text" value="16%(Max)"/> ProxCompNegCntMax: <input type="text" value="1"/></p> <p>PS LED(GPIO7) status when button touched: <input type="text" value="On"/> ProxStuckAtTimeout: <input type="text" value="0"/></p>						

Figure 41: Proximity Tab

The proximity tab allows the user to change the configuration of the proximity sensing.

5.8.5 Buzzer Tab

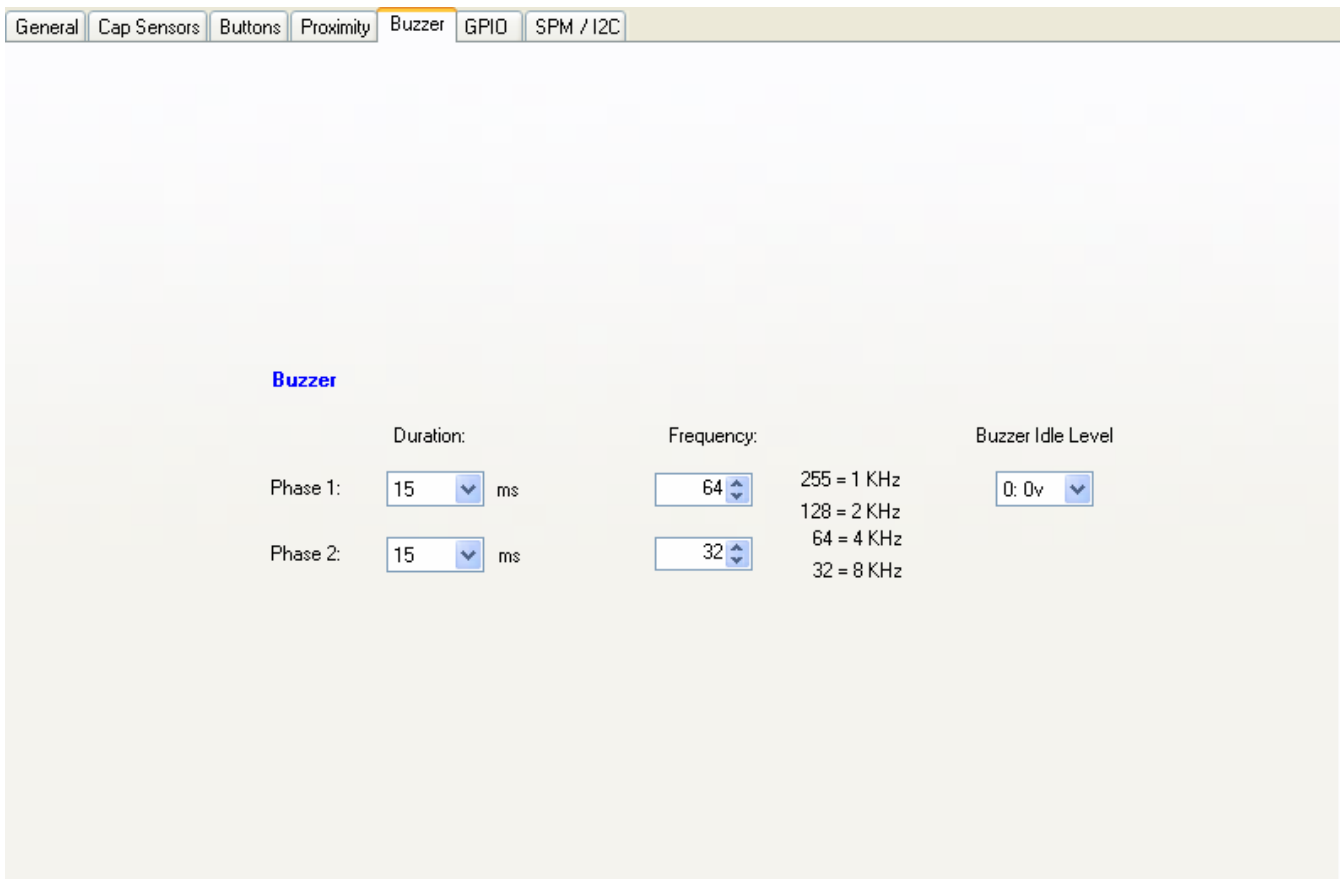


Figure 42: Buzzer Tab

The Buzzer tab allows the user to change the configuration of the Buzzer.

The Buzzer settings are only taken into account if GPIO7 is set to SPO/BUZ mode in the GPIO tab.

ADVANCED COMMUNICATIONS & SENSING

5.8.6 GPIO Tab

		IO7	IO6	IO5	IO4	IO3	IO2	IO1	IO0
SPM	Mode:	BUZ	GPO	GPO	GPO	GPO	GPO	GPO	GPO
	State after powerup:	OFF	OFF	OFF	OFF	OFF	OFF	OFF	OFF
	Autolight:	ON	ON	ON	ON	ON	ON	ON	ON
	Polarity:	Inverted	Normal	Normal	Normal	Normal	Normal	Normal	Normal
	ON intensity:	255	255	255	255	255	255	255	255
	OFF intensity:	0	0	0	0	0	0	0	0
	Function:	Log	Log	Log	Log	Log	Log	Log	Log
	Inc factor:	1	1	1	1	1	1	1	1
	Dec factor:	1	1	1	1	1	1	1	1
	Inc time:	OFF	OFF	OFF	OFF	OFF	OFF	OFF	OFF
	Dec time:	2.0 ms	2.0 ms	2.0 ms	2.0 ms	2.0 ms	2.0 ms	2.0 ms	2.0 ms
	OFF delay:	OFF	OFF	OFF	OFF	OFF	OFF	OFF	OFF
	..	disabled	disabled	disabled	disabled	disabled	disabled	disabled	disabled
	..	None	None	None	None	None	None	None	None
..	OFF	OFF	OFF	OFF	OFF	OFF	OFF	OFF	
Fading Mode	Single	Single	Single	Single	Single	Single	Single	Single	
I2C	GPO control:	OFF	OFF	OFF	OFF	OFF	OFF	OFF	OFF
	..	0	0	0	0	0	0	0	0

Figure 43: GPIO Tab

The GPIO tab allows the user to change the configuration of the GPIOs.

5.8.7 SPM/I2C Tab

General
Cap Sensors
Buttons
Proximity
Buzzer
GPIO
SPM / I2C

SPM

- General
- Cap Sensors
- Buttons
- Prox-Buzzer
- GPIO

General

I2C Registers

Register	Addr	Value
IrqSrc	0x00	0x02
CapStatKeys	0x01	0x00
Reserved0	0x02	0x00
Reserved1	0x03	0x00
Reserved2	0x04	0x00
Reserved3	0x05	0x00
Reserved4	0x06	0x00
Reserved5	0x07	0x00
SpmStat	0x08	0x09
CompOpMode	0x09	0x18
GpoCtrl	0x0A	0x00
Reserved6	0x0B	0x00
Reserved7	0x0C	0x00
SpmCfg	0x0D	0x00
SpmBaseAddr	0x0E	0x7F
Reserved8	0x0F	0x00
SpmKeyMsb	0xAC	0x00
SpmKeyLsb	0xAD	0x00
SoftReset	0xB1	0x00

Figure 44: SPM/I2C Tab

The SPM/I2C tab allows the user to change the configuration at low level.

The I2C registers can be directly written (white boxes). As soon as data is entered the data becomes red (indicating that the GUI is being updated but not yet the EVK) and is written to the EVK after the 'Enter' key (data becomes black again showing GUI and EVK are in sync).

The GUI reads the I2C registers at each interrupt from the EVK. A manual read/write of the I2C registers can be done by clicking the 'Update' button on the right side of this tab.

Rev 1 – 5th August 2011

37

www.semtech.com

ADVANCED COMMUNICATIONS & SENSING

The SPM is shown in this tab as hexadecimal values. Experienced users can enter data here directly without passing through the previous described tabs. The GUI ensures that entering data in this tab or in the other tabs remains coherent.

The details of the SPM can be shown by expanding each separate line (click on the '+' box).

SPM	
[-] General	
I2CAddress	0x2B
ActiveScanPeriod	0x02
DozeScanPeriod	0x0D
PassiveTimer	0x00
[+] Cap Sensors	
[+] Buttons	
[+] Prox-Buzzer	
[+] GPIO	
General	

Figure 45: SPM Expanding General

Hexadecimal values can be entered and will be written to the EVK immediately after the pushing the Enter key.

6 Schematics

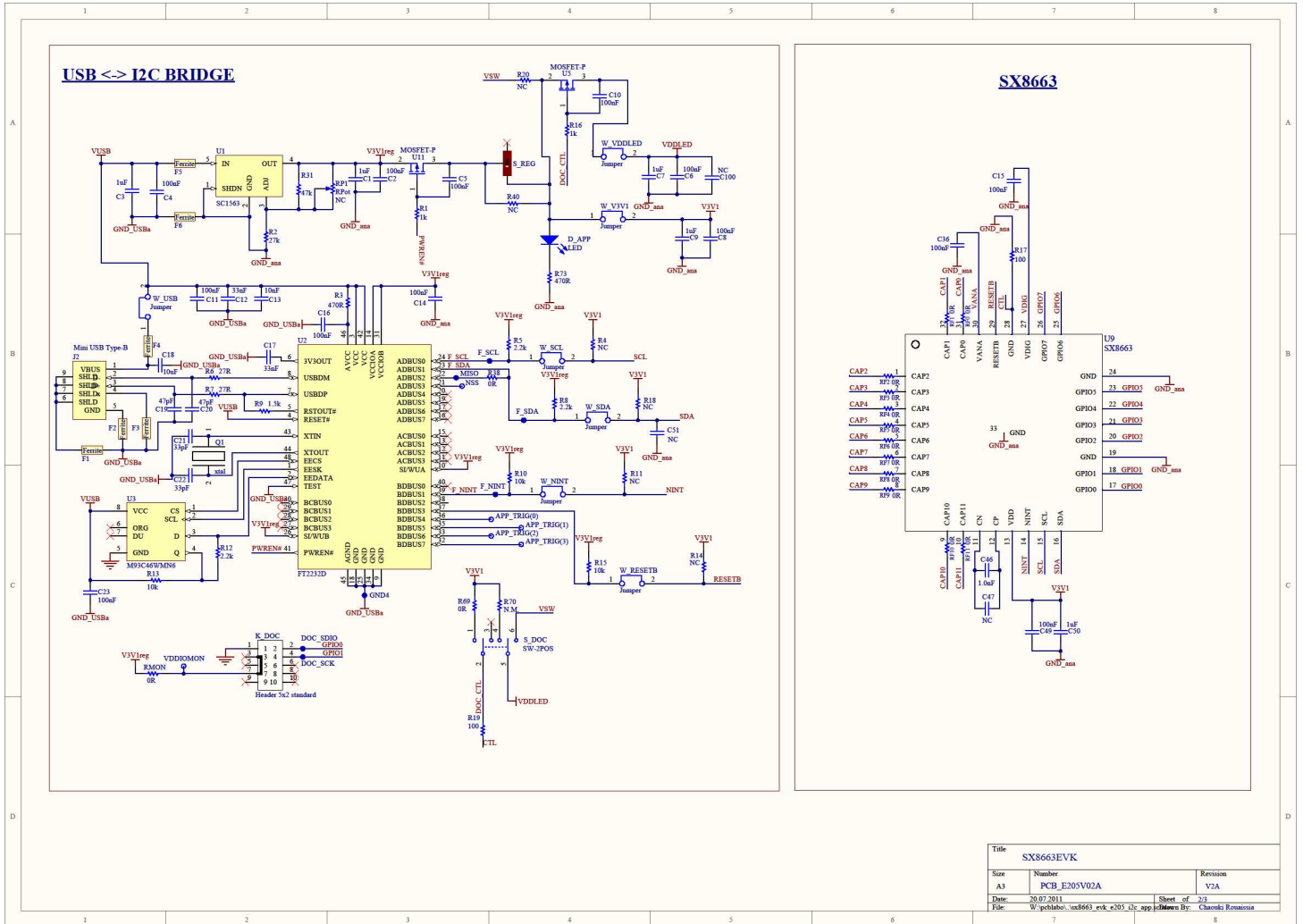


Figure 46: SX8663EVK Schematics (1/2)

ADVANCED COMMUNICATIONS & SENSING

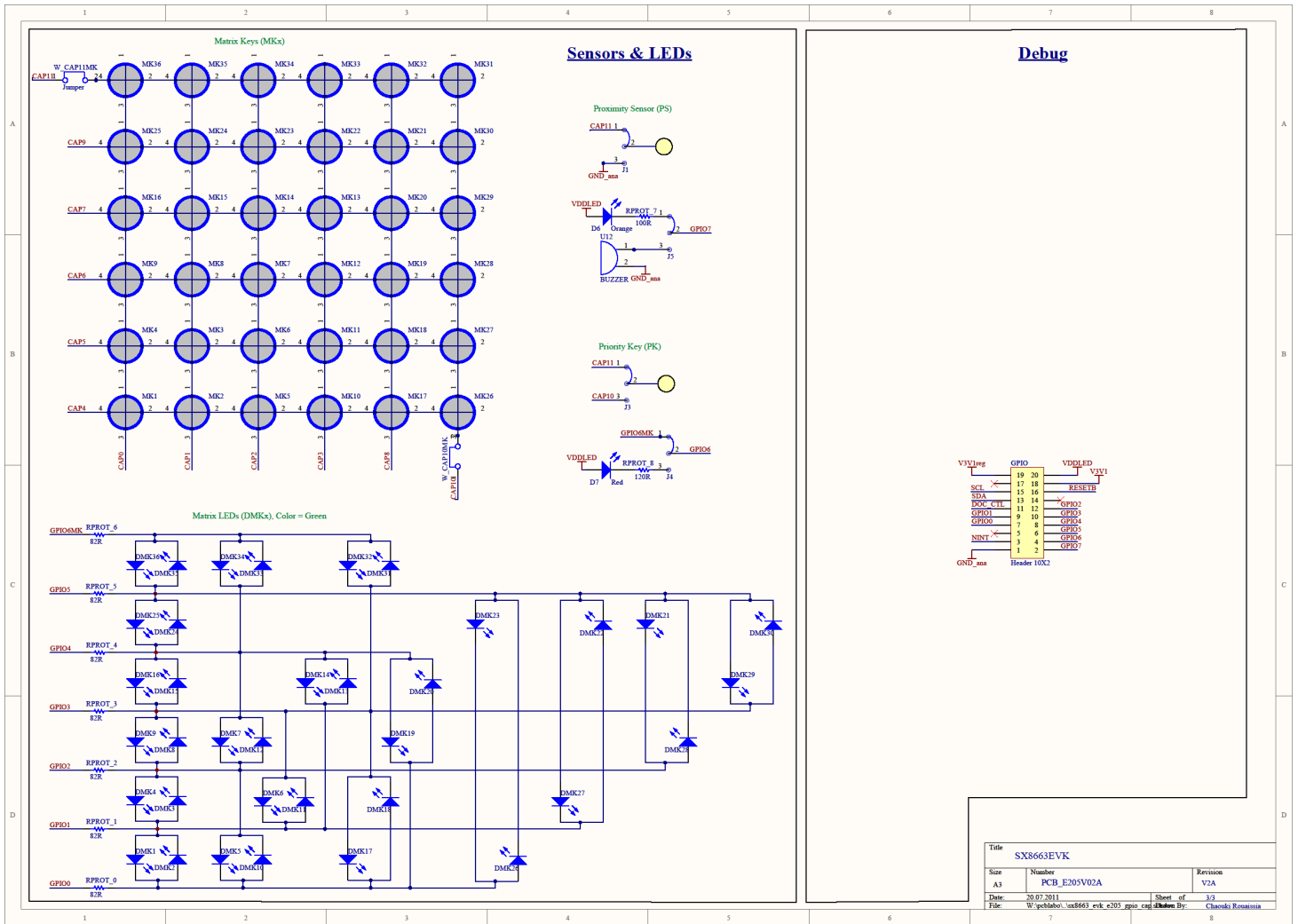


Figure 47: SX8663EVK Schematics (2/2)

7 Layout

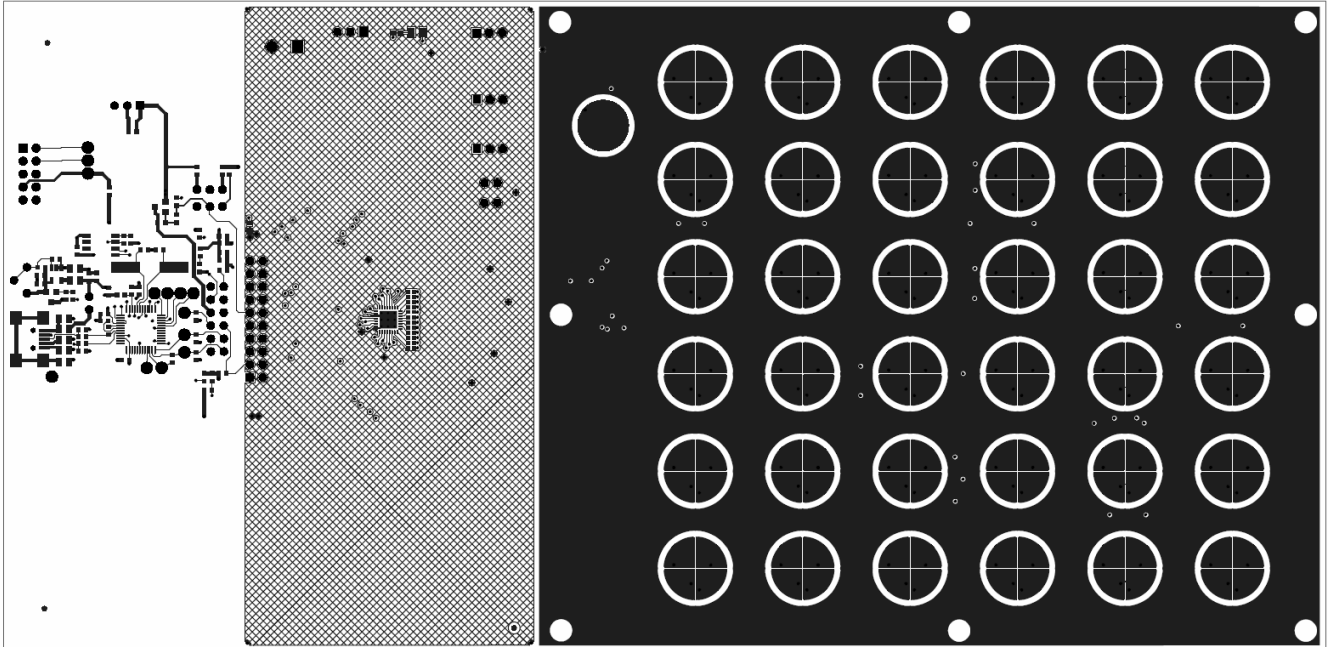


Figure 48: SX8663EVK Top layer

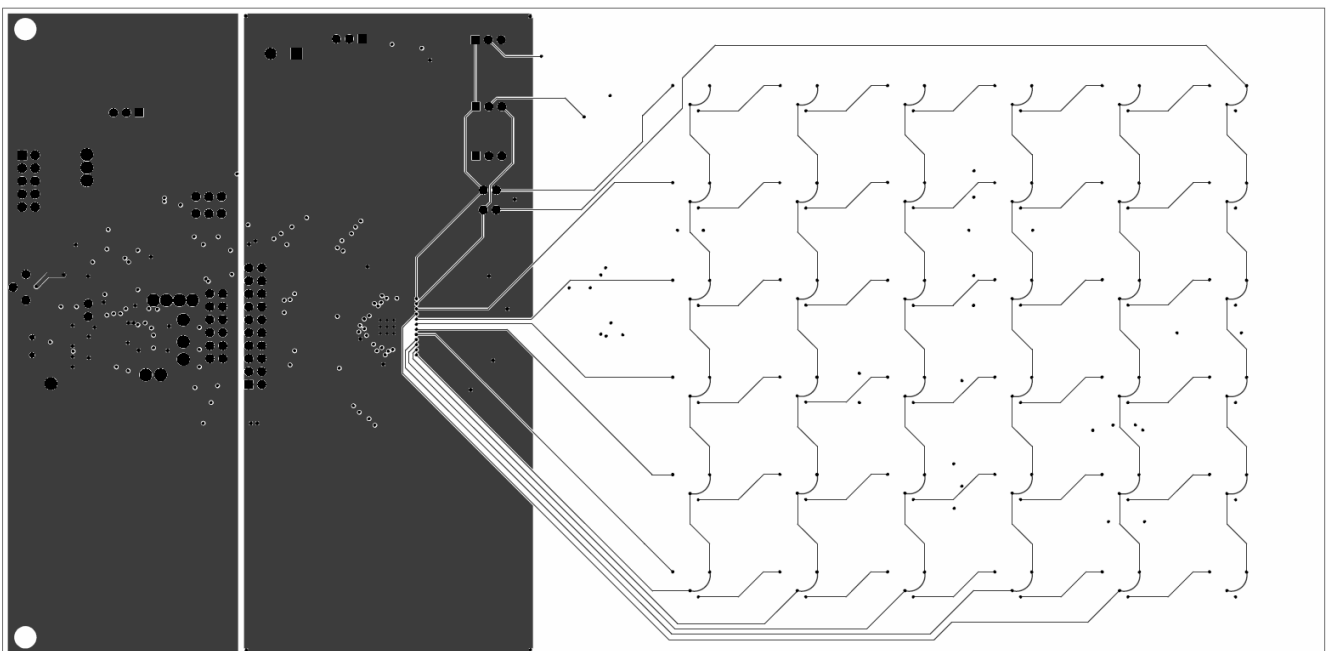


Figure 49: SX8663EVK Mid Layer 1

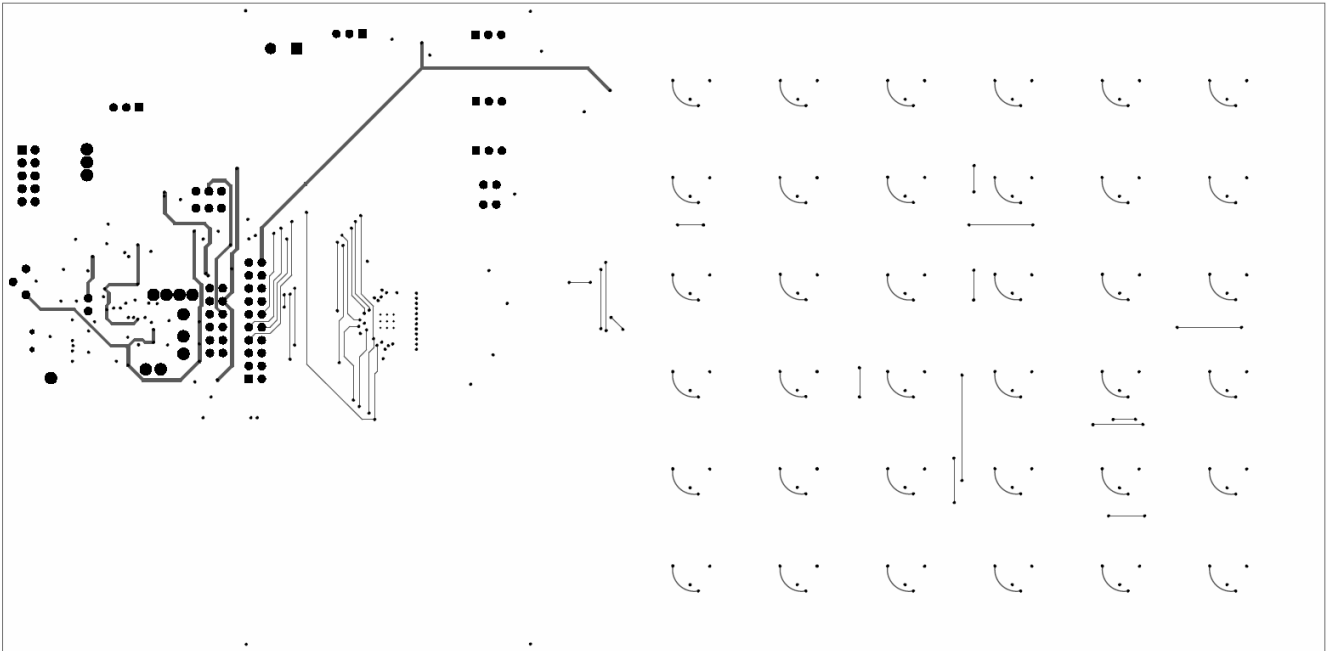
ADVANCED COMMUNICATIONS & SENSING

Figure 50: SX8663EVK Mid Layer 2

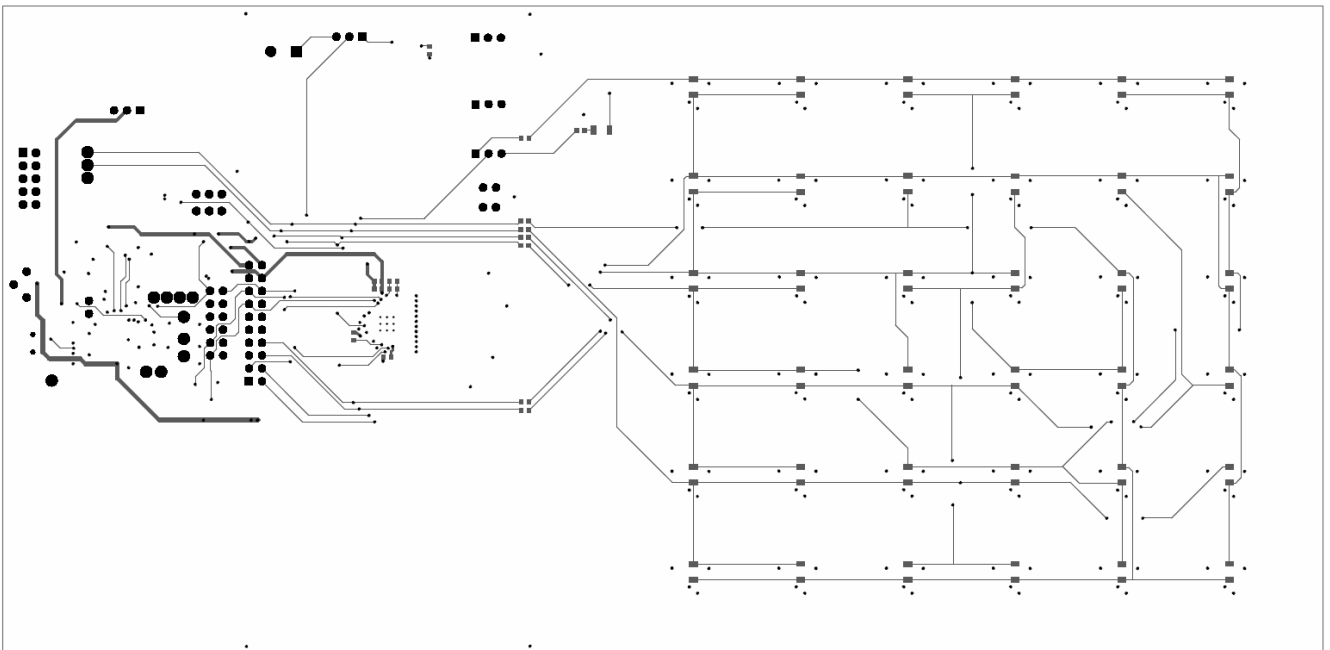


Figure 51: SX8663EVK Bottom Layer

8 References

- [1] SX8663 Datasheet

ADVANCED COMMUNICATIONS & SENSING

© Semtech 2011

All rights reserved. Reproduction in whole or in part is prohibited without the prior written consent of the copyright owner. The information presented in this document does not form part of any quotation or contract, is believed to be accurate and reliable and may be changed without notice. No liability will be accepted by the publisher for any consequence of its use. Publication thereof does not convey nor imply any license under patent or other industrial or intellectual property rights. Semtech assumes no responsibility or liability whatsoever for any failure or unexpected operation resulting from misuse, neglect improper installation, repair or improper handling or unusual physical or electrical stress including, but not limited to, exposure to parameters beyond the specified maximum ratings or operation outside the specified range.

SEMTECH PRODUCTS ARE NOT DESIGNED, INTENDED, AUTHORIZED OR WARRANTED TO BE SUITABLE FOR USE IN LIFE-SUPPORT APPLICATIONS, DEVICES OR SYSTEMS OR OTHER CRITICAL APPLICATIONS. INCLUSION OF SEMTECH PRODUCTS IN SUCH APPLICATIONS IS UNDERSTOOD TO BE UNDERTAKEN SOLELY AT THE CUSTOMER'S OWN RISK. Should a customer purchase or use Semtech products for any such unauthorized application, the customer shall indemnify and hold Semtech and its officers, employees, subsidiaries, affiliates, and distributors harmless against all claims, costs damages and attorney fees which could arise.

Notice: All referenced brands, product names, service names and trademarks are the property of their respective owners.

Contact Information

Semtech Corporation
Advanced Communications and Sensing Products Division
200 Flynn Road, Camarillo, CA 93012
Phone: (805) 498-2111 Fax: (805) 498-3804