

# Oscilloscope Probes and Probe Accessories

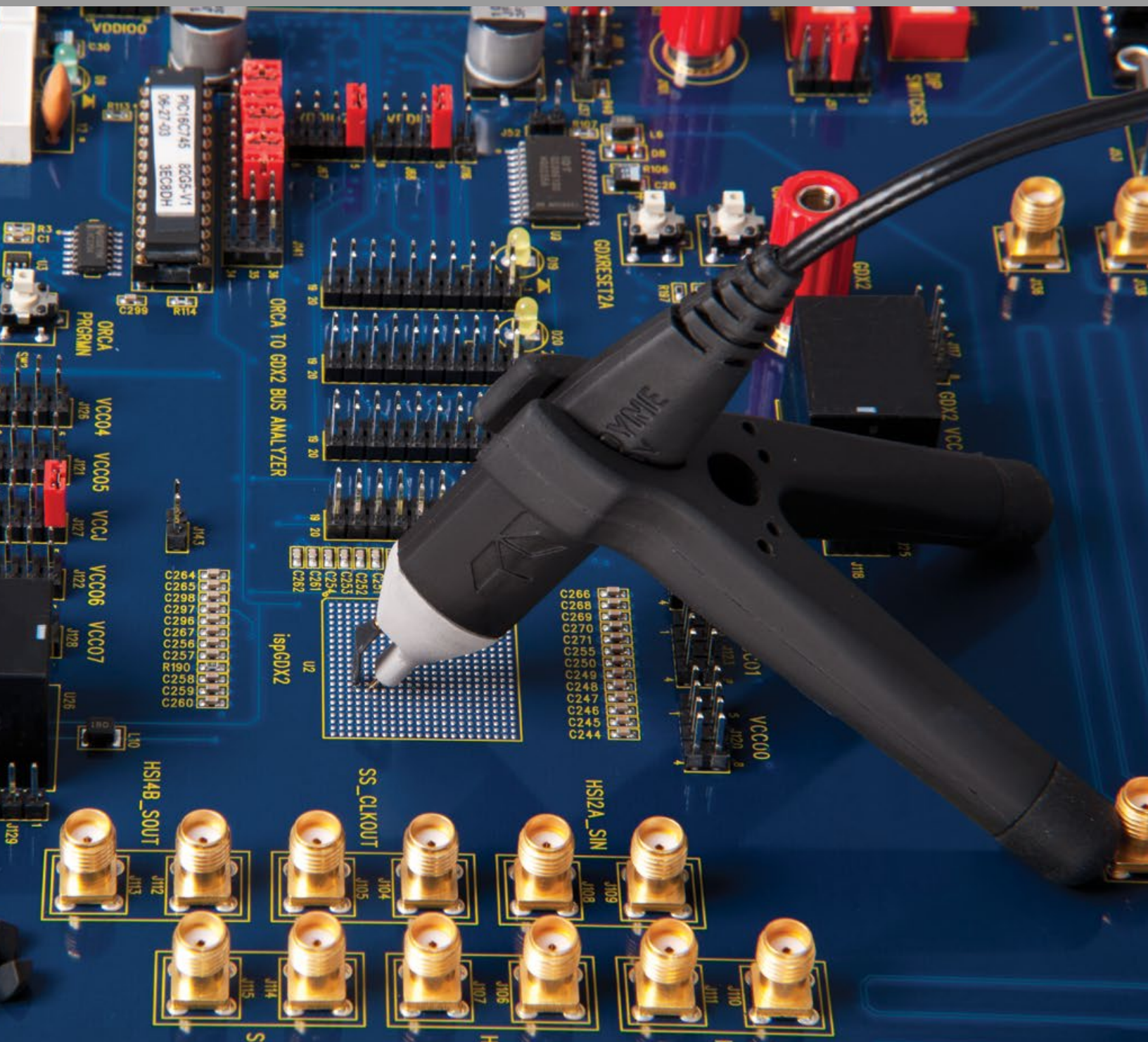

# PROBE SELECTION

Teledyne LeCroy has a wide variety of world class probes and amplifiers to compliment its product line. From the ZS high impedance active probes to the WaveLink differential probing system which offers bandwidths up to 25 GHz, Teledyne LeCroy probes and probe accessories provide optimum mechanical connections for signal measurement.



Front Cover:  
ZS Series High Impedance  
Active Probes

	WaveAce Oscilloscopes	WaveJet Oscilloscopes	WaveSurfer 3000 Oscilloscopes	WaveSurfer 10 / MXs-B / MSO MXs-B Oscilloscopes	HDO4000 / HDO4000-MS High Definition Oscilloscopes	WaveRunner 6 Zi Oscilloscopes	HDO6000 / HDO6000-MS High Definition Oscilloscopes	HDO8000 / HDO8000-MS High Definition Oscilloscopes	MDA800 Motor Drive Analyzers	HRO 12-bit Oscilloscopes	WavePro/SDA/DDA/7 Zi/7 Zi-A Oscilloscopes	WaveMaster/SDA/DDA/8 Zi/8 Zi-A Oscilloscopes	LabMaster 9 Zi-A Oscilloscopes	LabMaster 10 Zi-A Oscilloscopes
<b>Active Voltage Probes - p. 4 - 7</b>														
ZS1000		✓	✓	✓	✓	✓	✓	✓	✓	✓	✓	✓	✓	
ZS1500			✓	✓	✓	✓	✓	✓	✓	✓	✓	✓	✓	
ZS2500					✓						✓	✓	✓	✓
ZS4000					✓						✓	✓	✓	✓
<b>Current Probes - p. 8 - 11</b>														
CP030		✓	✓	✓	✓	✓	✓	✓	✓	✓	✓	✓	✓	✓
CP030A			✓	✓	✓	✓	✓	✓	✓	✓	✓	✓	✓	✓
CP031		✓	✓	✓	✓	✓	✓	✓	✓	✓	✓	✓	✓	✓
CP031A			✓	✓	✓	✓	✓	✓	✓	✓	✓	✓	✓	✓
CP150		✓	✓	✓	✓	✓	✓	✓	✓	✓	✓	✓	✓	✓
CP500		✓	✓	✓	✓	✓	✓	✓	✓	✓	✓	✓	✓	✓
<b>Differential Probes - p. 12 - 21</b>														
ZD200		✓	✓	✓	✓	✓	✓	✓	✓	✓	✓	✓	✓	✓
ZD500		✓	✓	✓	✓	✓	✓	✓	✓	✓	✓	✓	✓	✓
ZD1000		✓	✓	✓	✓	✓	✓	✓	✓	✓	✓	✓	✓	✓
ZD1500			✓	✓	✓	✓	✓	✓	✓	✓	✓	✓	✓	✓
AP033		✓	✓	✓	✓	✓	✓	✓	✓	✓	✓	✓	✓	✓
D410-PS					✓					✓	✓	✓	✓	✓
D420-PS					✓					✓	✓	✓	✓	✓
D400A-AT					✓					✓	✓	✓	✓	✓
D610-PS					✓					✓	✓	✓	✓	✓
D620-PS					✓					✓	✓	✓	✓	✓
D600A-AT					✓					✓	✓	✓	✓	✓
D830-PS											✓	✓	✓	✓
D1030-PS											✓	✓	✓	✓
D1330-PS											✓	✓	✓	✓
D1305-A-PS											✓	✓	✓	✓
D1605-A-PS											✓	✓	✓	✓
D2005-A-PS											✓	✓	✓	✓
D2505-A-PS											✓	✓	✓	✓
<b>High Voltage Differential Probes - p. 22 - 27</b>														
HVD3102		✓	✓	✓	✓	✓	✓	✓	✓	✓	✓	✓	✓	✓
HVD3106		✓	✓	✓	✓	✓	✓	✓	✓	✓	✓	✓	✓	✓
HVD3106-6M		✓	✓	✓	✓	✓	✓	✓	✓	✓	✓	✓	✓	✓
ADP300		✓	✓	✓	✓	✓	✓	✓	✓	✓	✓	✓	✓	✓
ADP305		✓	✓	✓	✓	✓	✓	✓	✓	✓	✓	✓	✓	✓
AP031	✓	✓	✓	✓	✓	✓	✓	✓	✓	✓	✓	✓	✓	✓

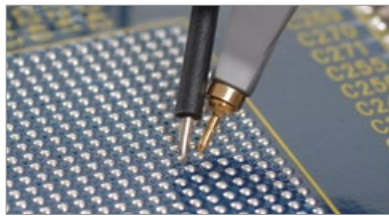
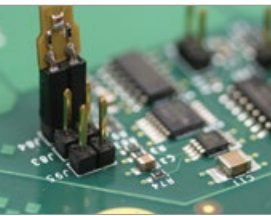

*WaveAce Oscilloscopes*  
*WaveJet Oscilloscopes*  
*WaveSurfer 3000 Oscilloscopes*  
*WaveSurfer 10 / MXs-B / MSO*  
*MXs-B Oscilloscopes*  
*HDO4000 / HDO4000-MS*  
*High Definition Oscilloscopes*  
*WaveRunner 6 Zi*  
*Oscilloscopes*  
*HDO6000 / HDO6000-MS*  
*High Definition Oscilloscopes*  
*HDO8000 / HDO8000-MS*  
*High Definition Oscilloscopes*  
*MDA800 Motor Drive Analyzers*  
*HRO 12-bit Oscilloscopes*  
*WavePro/SDA/DDA/7 Zi/7 Zi-A*  
*Oscilloscopes*  
*WaveMaster/SDA/DDA/8 Zi/8 Zi-A*  
*Oscilloscopes*  
*LabMaster 9 Zi-A Oscilloscopes*  
*LabMaster 10 Zi-A Oscilloscopes*

	<i>WaveAce Oscilloscopes</i>	<i>WaveJet Oscilloscopes</i>	<i>WaveSurfer 3000 Oscilloscopes</i>	<i>WaveSurfer 10 / MXs-B / MSO</i>	<i>MXs-B Oscilloscopes</i>	<i>HDO4000 / HDO4000-MS</i>	<i>High Definition Oscilloscopes</i>	<i>WaveRunner 6 Zi</i>	<i>Oscilloscopes</i>	<i>HDO6000 / HDO6000-MS</i>	<i>High Definition Oscilloscopes</i>	<i>HDO8000 / HDO8000-MS</i>	<i>High Definition Oscilloscopes</i>	<i>MDA800 Motor Drive Analyzers</i>	<i>HRO 12-bit Oscilloscopes</i>	<i>WavePro/SDA/DDA/7 Zi/7 Zi-A</i>	<i>Oscilloscopes</i>	<i>WaveMaster/SDA/DDA/8 Zi/8 Zi-A</i>	<i>Oscilloscopes</i>	<i>LabMaster 9 Zi-A Oscilloscopes</i>	<i>LabMaster 10 Zi-A Oscilloscopes</i>
<b>Differential Amplifiers - p. 28 - 31</b>																					
DXC200		✓	✓	✓	✓	✓	✓	✓	✓	✓	✓	✓	✓	✓	✓	✓	✓	✓	✓	✓	✓
DA101		✓	✓	✓	✓	✓	✓	✓	✓	✓	✓	✓	✓	✓	✓	✓	✓	✓	✓	✓	✓
DA1855A		✓	✓	✓	✓	✓	✓	✓	✓	✓	✓	✓	✓	✓	✓	✓	✓	✓	✓	✓	✓
DA1855A-PR2		✓	✓	✓	✓	✓	✓	✓	✓	✓	✓	✓	✓	✓	✓	✓	✓	✓	✓	✓	✓
DA1855A-PR2-RM		✓	✓	✓	✓	✓	✓	✓	✓	✓	✓	✓	✓	✓	✓	✓	✓	✓	✓	✓	✓
DA1855A-RM		✓	✓	✓	✓	✓	✓	✓	✓	✓	✓	✓	✓	✓	✓	✓	✓	✓	✓	✓	✓
DXC-5100		✓	✓	✓	✓	✓	✓	✓	✓	✓	✓	✓	✓	✓	✓	✓	✓	✓	✓	✓	✓
DXC100A		✓	✓	✓	✓	✓	✓	✓	✓	✓	✓	✓	✓	✓	✓	✓	✓	✓	✓	✓	✓
<b>High Voltage Probes - p. 32 - 37</b>																					
HVP120	✓	✓	✓	✓	✓	✓	✓	✓	✓	✓	✓	✓	✓	✓	✓	✓	✓	✓	✓	✓	✓
PPE1.2KV	✓	✓	✓	✓	✓	✓	✓	✓	✓	✓	✓	✓	✓	✓	✓	✓	✓	✓	✓	✓	✓
PPE2KV	✓	✓	✓	✓	✓	✓	✓	✓	✓	✓	✓	✓	✓	✓	✓	✓	✓	✓	✓	✓	✓
PPE4KV	✓	✓	✓	✓	✓	✓	✓	✓	✓	✓	✓	✓	✓	✓	✓	✓	✓	✓	✓	✓	✓
PPE5KV	✓	✓	✓	✓	✓	✓	✓	✓	✓	✓	✓	✓	✓	✓	✓	✓	✓	✓	✓	✓	✓
PPE6KV	✓	✓	✓	✓	✓	✓	✓	✓	✓	✓	✓	✓	✓	✓	✓	✓	✓	✓	✓	✓	✓
<b>Optical Probes - p. 38 - 41</b>																					
OE425							✓									✓	✓	✓	✓	✓	✓
OE455							✓									✓	✓	✓	✓	✓	✓
OE525																✓	✓	✓	✓	✓	✓
OE555																✓	✓	✓	✓	✓	✓
OE695G																✓	✓	✓	✓	✓	✓
<b>Passive Probes - p. 42 - 45</b>																					
PP006A		✓																			
PP007-WR																✓	✓	✓	✓	✓	✓
PP008					✓			✓							✓						
PP009					✓			✓							✓						
PP010		✓																			
PP011					✓											✓	✓	✓	✓	✓	✓
PP016	✓																				
PP017						✓															
PP018						✓				✓	✓	✓									
PP019					✓																
PP020					✓																
<b>Transmission Line Probes - p. 46 - 47</b>																					
PP066																✓	✓	✓	✓	✓	✓

Note: Some probes require purchase of the amplifier and platform/cable assembly separately – Reference detailed literature for more information.

# ACTIVE VOLTAGE PROBES

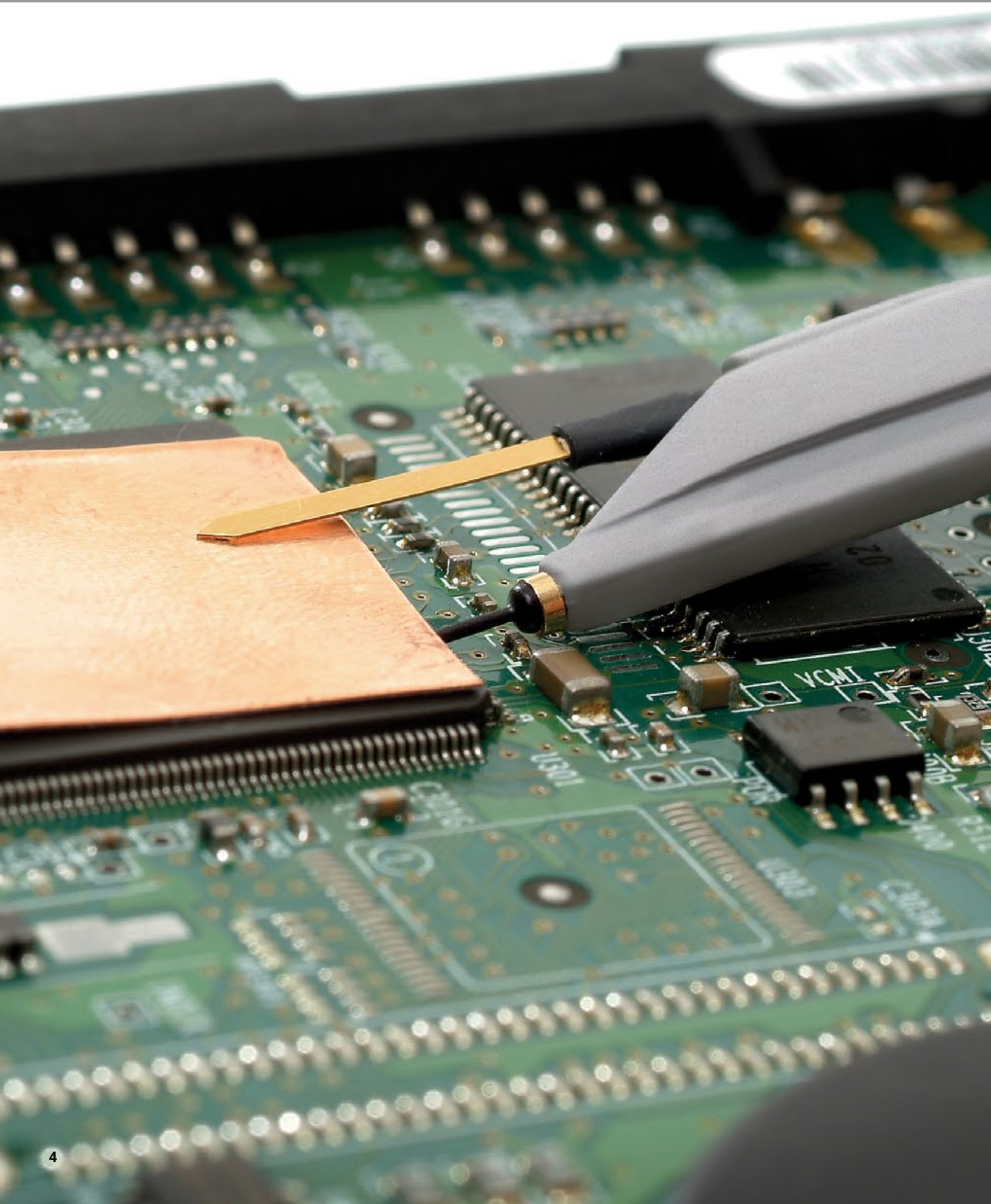

Engineers must commonly probe high-frequency signals with high signal fidelity. Typical passive probes with high input R and C provide good response at lower frequencies, but inappropriately load the circuit and distort signals at higher frequencies. Active voltage probes feature both high input R and low input C to reduce circuit loading across the entire probe/oscilloscope bandwidth. With low circuit loading and a form factor that allows probing in confined areas, the active voltage probe becomes the everyday probe for all different types of signals and connection points.

Teledyne LeCroy  
Active Voltage Probes  
Model Numbers:

ZS1000  
ZS1500  
ZS2500  
ZS4000

*Opposite page:  
ZS Series High Impedance Active Probe*

# ZS SERIES ACTIVE PROBES



Teledyne LeCroy  
Active Voltage Probe  
Model Numbers:

**ZS1000**  
**ZS1500**  
**ZS2500**  
**ZS4000**

The ZS Series probes are high impedance, low capacitance active probes that maintain high signal fidelity through 4 GHz. A small form factor and a wide variety of accessories ensures the ZS probe meets every difficult probing challenge.

Engineers must commonly probe high frequency signals with high signal fidelity. Typical passive probes with high input R and C provide good response at lower frequencies but inappropriately load the circuit and distort signals at higher frequencies. The ZS Series features both high input R (1 M $\Omega$ ) and low input C (0.6 pF and 0.9 pF) to reduce circuit loading across the entire probe/oscilloscope bandwidth. The ZS1000 is ideal for 200–600 MHz oscilloscopes. The ZS1500 is ideal for 1 GHz oscilloscopes, the ZS2500 is ideal for 2 GHz oscilloscopes, and the ZS4000 is ideal for 2.5 GHz and 4 GHz oscilloscopes.

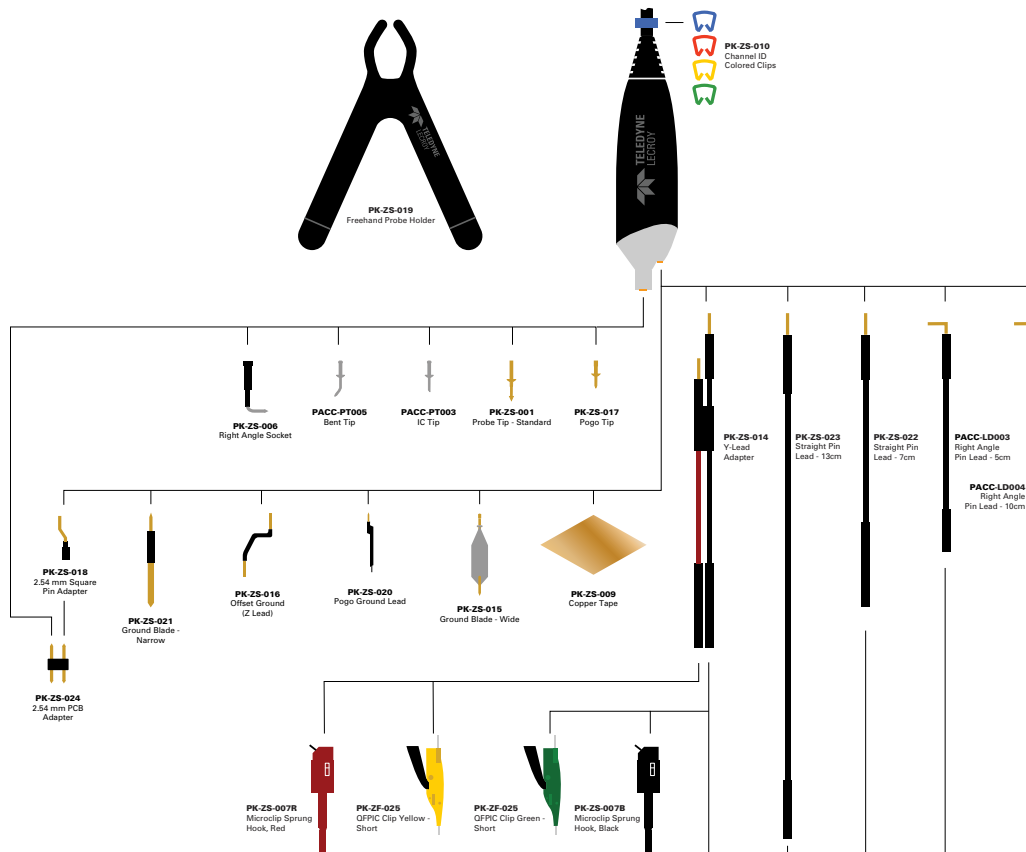

**ZS4000**

# ZS SERIES ACTIVE PROBES

ZS1000  
ZS1500  
ZS2500

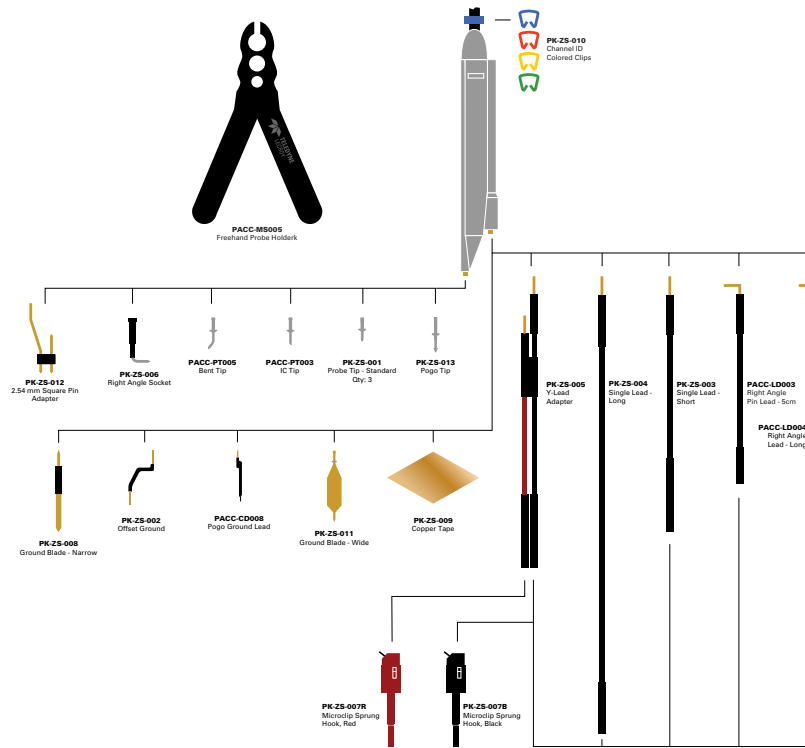

## Ordering Information

### Product Description

Product Description	Product Code
4 GHz, 0.6 pF, 1 M $\Omega$ High Impedance Active Probe	ZS4000
2.5 GHz, 0.9 pF, 1 M $\Omega$ High Impedance Active Probe	ZS2500
1.5 GHz, 0.9 pF, 1 M $\Omega$ High Impedance Active Probe	ZS1500
1 GHz, 0.9 pF, 1 M $\Omega$ High Impedance Active Probe	ZS1000
Set of 4 ZS2500, 2.5 GHz, 0.9 pF, 1 M $\Omega$ High Impedance Active Probes	ZS2500-QUADPAK
Set of 4 ZS1500, 1.5 GHz, 0.9 pF, 1 M $\Omega$ High Impedance Active Probes	ZS1500-QUADPAK
Set of 4 ZS1000, 1 GHz, 0.9 pF, 1 M $\Omega$ High Impedance Active Probes	ZS1000-QUADPAK

### Standard Accessory/Quantity

Accessory Description	Replacement Part Number	ZS1000	ZS1500	ZS2500	ZS4000
2.54 mm PCB Adaptor	PK-ZS-024				5
2.54mm Square Pin Adapter	PK-ZS-012	1			
2.54mm Square Pin Adaptor	PK-ZS-018				1
IC Tip	PACC-PT003	1	1		
Bent Tip	PACC-PT005	1	1		
Channel ID Clips (Set of 4 colors)	PK-ZS-010	4	1		
Copper Tape Pad	PK-ZS-009	2	2		
Freehand Probe Holder	PK-ZS-019				1
Freehand Probe Holder	PACC-MS005	1			
Ground Blade – Narrow	PK-ZS-008	1			
Ground Blade – Wide	PK-ZS-011	1			
Ground Blade, Narrow	PK-ZS-021				1
Ground Blade, Wide	PK-ZS-015				2
Micro-Grabber Pair	PK-ZS-007R and PK-ZS-007B	1			2
Offset Ground	PK-ZS-016				2

## Specifications ZS1000 ZS1500 ZS2500 ZS4000

### Electrical Characteristics

Electrical Characteristics	ZS1000	ZS1500	ZS2500	ZS4000
Probe Bandwidth	1 GHz	1.5 GHz	2.5 GHz	4 GHz
Input Capacitance		0.9 pF		0.6 pF
DC Input Resistance			1 M $\Omega$	
Probe Offset Range	N/A		$\pm 12$ V	
Attenuation			$\div 10$	
Input Dynamic Range			$\pm 8$ V	
Non-destruct Voltage			20 V	

### General Characteristics

Cable Length	1.3 m
--------------	-------

# CURRENT PROBES

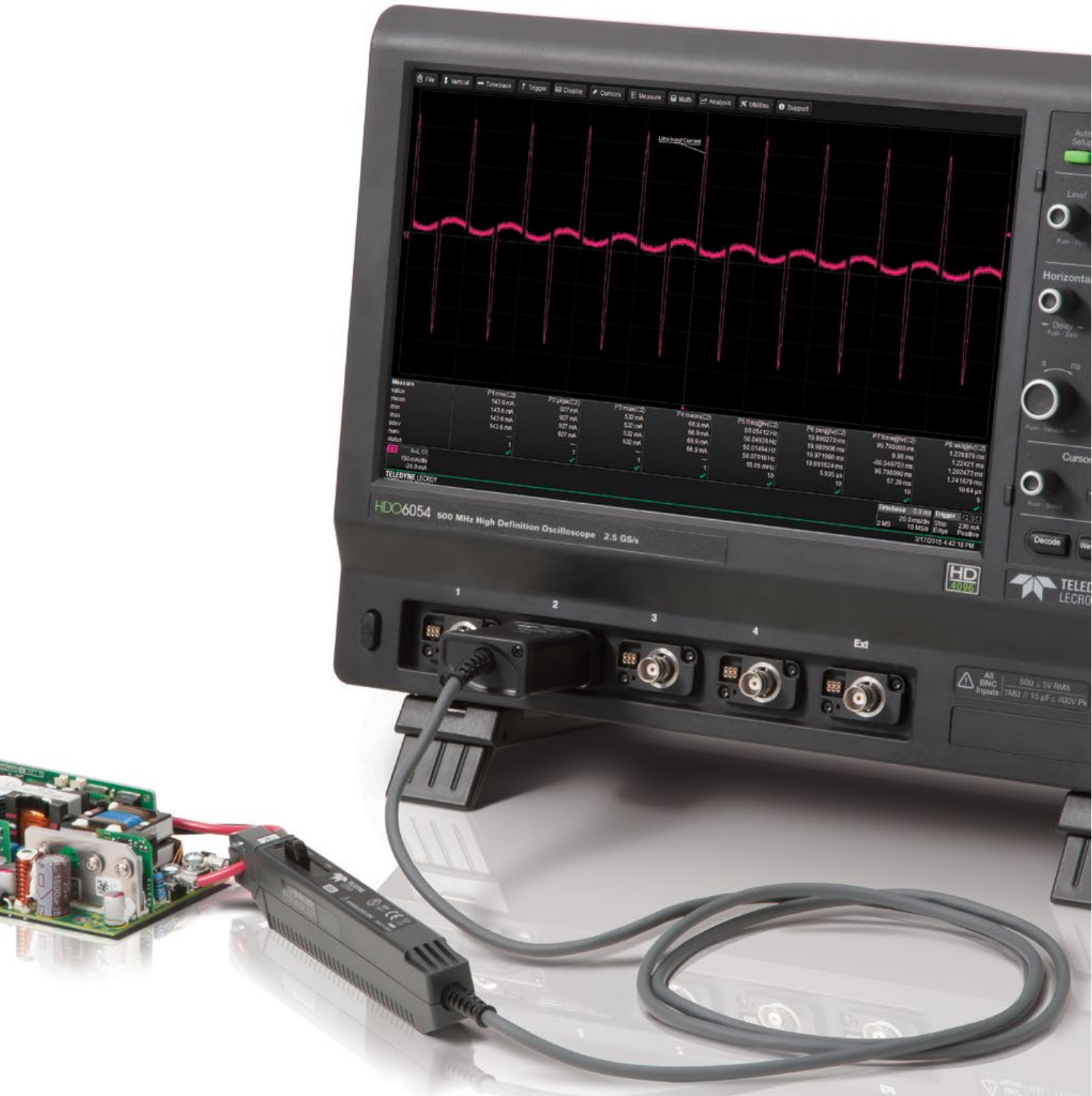



**Teledyne LeCroy current probes do not require the breaking of a circuit or the insertion of a shunt to make accurate and reliable current measurements. Based on a combination of Hall effect and transformer technology, Teledyne LeCroy current probes are ideal for making accurate AC, DC, and impulse current measurements.**

## Wide Range of Applications

Teledyne LeCroy current probes are available in a variety of models for a wide range of applications. The full range of Teledyne LeCroy current probes includes models with bandwidths up to 100 MHz, peak currents up to 700 A and sensitivities to 1 mA/div. Teledyne LeCroy current probes are often used in applications such as the design and test of switching power supplies, motor drives, electric vehicles, and uninterruptible power supplies.

## High Sensitivity

The CP030A and CP031A provide a high sensitivity of 1 mA/div. This allows for more precise low current measurements on Teledyne LeCroy oscilloscopes. When used with HDO high definition oscilloscopes with HD4096 technology, users will obtain highly accurate, low current waveforms with unmatched 12-bit resolution for improved debug and analysis.

## Fully Integrated

All Teledyne LeCroy current probes are powered through the Teledyne LeCroy ProBus® connection and require no additional hardware. Along with providing power, the ProBus connection allows the current probe and oscilloscope to communicate, resulting in current waveforms automatically displayed on screen in Amps, and calculated power traces scaled correctly in Watts. This full integration also allows for Degauss and Autozero functions to be done directly from the oscilloscope's user interface.

## Deskew Calibration Source

The DCS015 deskew calibration source has both voltage and current time-aligned signals, which enables the precise deskew of voltage and current probes. Most voltage probes along with the CP030, CP030A, CP031, and CP031A are compatible with the DSC015.

Teledyne LeCroy  
Current Probes  
Model Numbers:

CP030  
CP030A  
CP031  
CP031A  
CP150  
CP500  
DCS015

*Opposite page:  
CP031, 30A, 100 MHz Current Probe.*

# CURRENT PROBES



Teledyne LeCroy  
Current Probes  
Model Numbers:  
**CP030**  
**CP030A**  
**CP031**  
**CP031A**  
**CP150**  
**CP500**  
**DCS015**

## Features

- ProBus active probe interface with automatic scaling in A/div
- Autozero and degauss capabilities built into instrument's user interface
- Wide range of input currents and bandwidth capabilities



- **CP030**
  - 30 A<sub>rms</sub> continuous current
  - 50 A<sub>peak</sub> current
  - 50 MHz bandwidth



- **CP030A**
  - 30 A<sub>rms</sub> continuous current
  - 50 A<sub>peak</sub> current
  - 50 MHz bandwidth
  - 1 mA/div sensitivity



- **CP031**
  - 30 A<sub>rms</sub> continuous current
  - 50 A<sub>peak</sub> current
  - 100 MHz bandwidth



- **CP031A**
  - 30 A<sub>rms</sub> continuous current
  - 50 A<sub>peak</sub> current
  - 100 MHz bandwidth
  - 1 mA/div sensitivity



- **CP150**
  - 150 A<sub>rms</sub> continuous current
  - 500 A<sub>peak</sub> current
  - 10 MHz bandwidth



- **CP500**
  - 500 A<sub>rms</sub> continuous current
  - 700 A<sub>peak</sub> current
  - 2 MHz bandwidth



- **DCS015**
  - Precise deskew of voltage and current probes.
  - Compatible with the CP031, CP031A, CP030, and CP030A

Specifications	CP030 <sup>†</sup>	CP030A <sup>†</sup>	CP031 <sup>†</sup>	CP031A <sup>†</sup>	CP150	CP500
<b>Electrical Characteristics*</b>						
Max. Continuous Input Current	30 A <sub>rms</sub>				150 A <sub>rms</sub>	500 A <sub>rms</sub>
Bandwidth	50 MHz		100 MHz		10 MHz	2 MHz
Rise Time (typical)	≤ 7 ns		≤ 3.5 ns		≤ 35 ns	≤ 175 ns
Max. Peak Current (non-continuous)	50 A <sub>peak</sub>				300 A <sub>peak</sub>	700 A <sub>peak</sub>
Output Voltage	0.1 V/A	0.1 V/A & 1 V/A	0.1 V/A	0.1 V/A & 1 V/A	0.01 V/A	
Max Continuous Input Current at 1 V/A (100mA/div or less)	–	5 A	–	5 A	–	
Offset Range at 1V/A (100mA/div or less)	–	±5 A	–	±5 A	–	
Minimum Sensitivity	10 mA/div	1 mA/div	10 mA/div	1 mA/div	100 mA/div	
Low-Frequency Accuracy	1%					
AC Noise at 20 MHz BWL	≤ 2.5 mA	≤ 150 μA	≤ 2.5 mA	≤ 150 μA	≤ 6.0 mA	≤ 8.0 mA
Coupling	AC, DC, GND					

## General Characteristics

Cable Length	1.5 m				2 m	6 m
Weight	240 g	260 g	240 g	260 g	500 g	630 g
Max. Conductor Size (Diameter)	5 mm				20 mm	
Interface	ProBus, 1 MΩ only					
Usage Environment	Indoor					
Operating Temperature	0° C to 40° C					
Max. Relative Humidity	80%					
Max. Altitude	2000 m					
Maximum Insulated Wire Voltage	300 V CAT I				600 V CAT II, 300 V CAT III	

\* Electrical Characteristics Guaranteed at 23 °C ±3 °C

† The CP031 and CP030 require the Teledyne LeCroy oscilloscope to be running firmware version 4.3.1.1 or greater. The CP031A and CP030A require firmware version 7.7.1.Xa or greater. The CP030A and CP031A are not compatible with the WaveSurfer 3000 series.

## Ordering Information

Product Description	Product Code
30 A; 50 MHz Current Probe – AC/DC; 30 A <sub>rms</sub> ; 50 A Peak Pulse	CP030
30 A; 50 MHz High Sensitivity Current Probe – AC/DC; 30 A <sub>rms</sub> ; 50 A Peak Pulse	CP030A
30 A; 100 MHz Current Probe – AC/DC; 30 A <sub>rms</sub> ; 50 A Peak Pulse	CP031
30 A; 100 MHz High Sensitivity Current Probe – AC/DC; 30 A <sub>rms</sub> ; 50 A Peak Pulse	CP031A
150 A; 10 MHz Current Probe – AC/DC; 150 A <sub>rms</sub> ; 500 A Peak Pulse	CP150
500 A; 2 MHz Current Probe – AC/DC; 500 A <sub>rms</sub> ; 700 A Peak Pulse	CP500
Deskew Calibration Source for CP031,CP031A, CP030, CP030A and AP015	DCS015

# DIFFERENTIAL PROBES

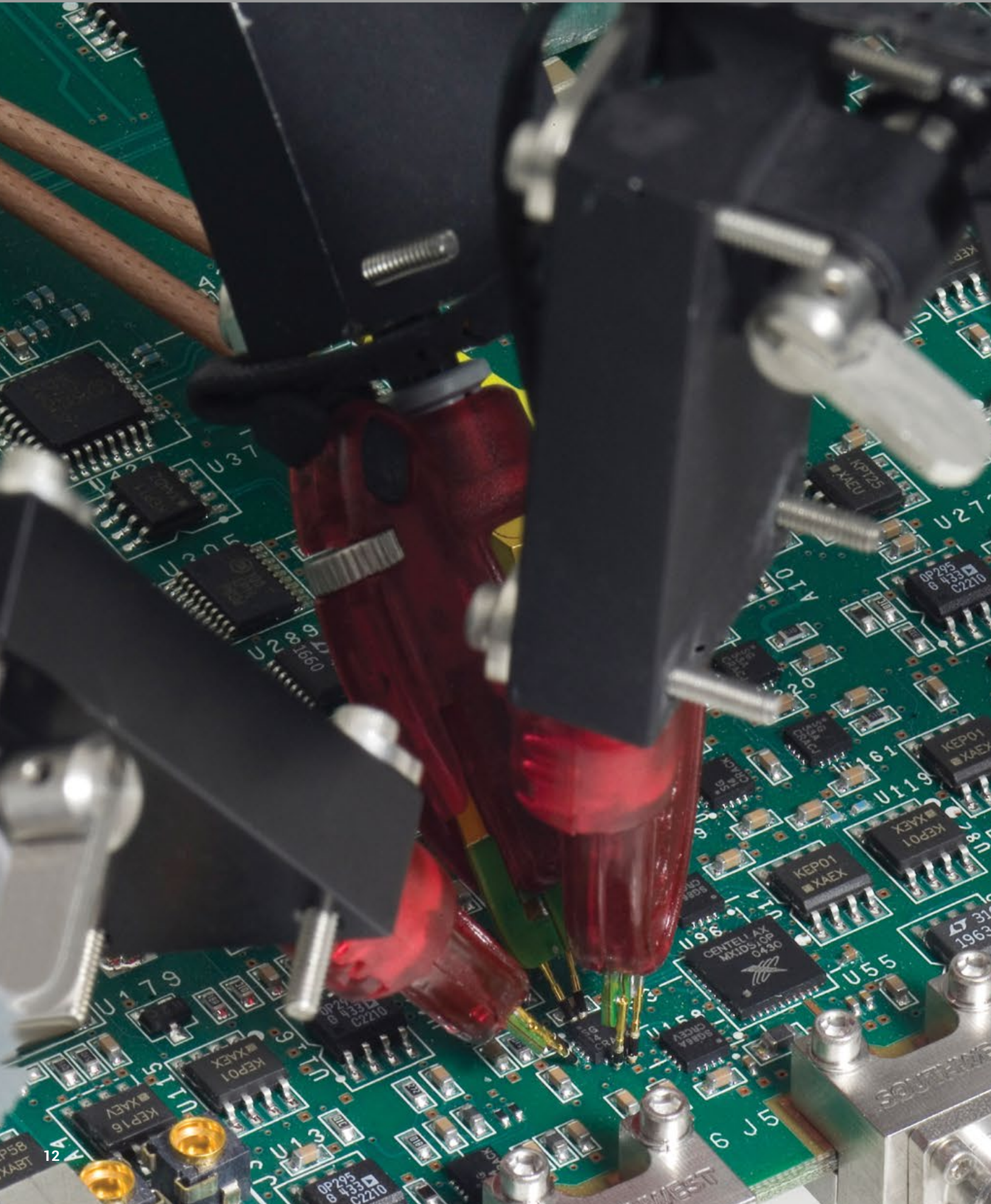

**Differential active probes are like two probes in one. Instead of measuring a test point in relation to a ground point (like single-ended active probes), differential probes measure the difference in voltage of a test point in relation to another test point.**

Teledyne LeCroy  
Differential Probes  
Model Numbers:

≤ 1.5 GHz

ZD200

ZD500

ZD1000

ZD1500

AP033

4 GHz - 6 GHz

D410-PS

D420-PS

D400A-AT

D610-PS

D620-PS

D600A-AT

8 GHz - 13 GHz

D830-PS

D1030-PS

D1330-PS

13 GHz - 25 GHz

D1305-PS

D1605-PS

D2005-PS

D2505-PS

*Opposite page:  
WaveLink® High Bandwidth Differential Probing System  
(13 GHz – 25 GHz)*

# ≤ 1.5 GHz DIFFERENTIAL PROBES



Teledyne LeCroy  
≤1.5 GHz  
Differential Probe  
Model Numbers:

**ZD200**  
**ZD500**  
**ZD1000**  
**ZD1500**  
**AP033**

The ZD Series probes provide wide dynamic range, excellent noise and loading performance and an extensive set of probe tips, leads, and ground accessories to handle a wide range of probing scenarios. The low 1 pF capacitance means this probe is ideal for all frequencies. The ZD Series differential probes provide full system bandwidth for all Teledyne LeCroy Oscilloscopes 1.5 GHz and lower.

## Fully Integrated

With the ProBus interface, the ZD500, 1000, and 1500 become an integral part of the oscilloscope. All probe gain and offset controls are transparent to the user, making it easier to probe the circuit without concern for which gain setting to choose. When used with a Teledyne LeCroy digital oscilloscope, no external power supply is required.

## Wide Dynamic Range

The ZD500, 1000, 1500 probes provide transparent probe attenuation so signals are always optimized for the display. The differential range is 18 V<sub>p-p</sub> with a differential offset of ±8V and common mode range of ±10 V, making these probes versatile for every probing application.

## Wide Applications

The wide dynamic range of 16 V<sub>p-p</sub> and offset range of ±8V suit this probe to a wide range of applications and signal types. The ZD differential probes are ideally suited for Automotive, Serial Data, power, and general purpose use.

## Specifications

### Electrical Characteristics

	ZD200	ZD500	ZD1000	ZD1500
Bandwidth (Warranted)	200 MHz	500 MHz	1000 MHz	1500 MHz
Bandwidth (Typical)	-	650 MHz	1200 MHz	1700 MHz
Risetime 10–90% (Typical)	1.75 ns	650 ps	375 ps	270 ps
Risetime 20–80% (Typical)	-	500 ps	280 ps	200 ps
LF Attenuation Accuracy (Warranted)	1%		2%	
Zero Offset (Typical) (within 15 minutes after autozero)	-		5 mV	
System Noise (Typical)	-	1.3 mV <sub>rms</sub>		1.75 mV <sub>rms</sub>
Probe Noise Density (Typical)	3 mV <sub>rms</sub>		38 nV/rt (Hz)	
Input Differential Range (Nominal)	± 20 V		±8 V (16 V <sub>p-p</sub> )	
Differential Offset Range (Nominal)	-		±18 V	
Offset Gain Accuracy (Typical)	-		2%	
Common Mode Range (Nominal)	± 60 V		±10 V	
Maximum Non-destruct Voltage (Nominal)	-		30 V	
CMRR (Typical)	80 dB @ 60 Hz 50 dB@10 MHz	60 dB 50/60 Hz 30 dB 20 MHz 25 dB 500 MHz	60 dB 50/60 Hz 30 dB 20 MHz 25 dB @ 1000 MHz	60 dB 50/60 Hz 30 dB 20 MHz 25 dB @ 1500 MHz
DC Input Resistance (Nominal)	250 kΩ (Common Mode) 1 MΩ (Differential Mode)		50 kΩ (Common Mode) 120 kΩ (Differential Mode)	
Differential Input Capacitance (Typical)	3.5 pF		< 1.0 pF	

## Ordering Information

### Product Description

Product Description	Product Code
200 MHz, 3.5 pF, 1 MΩ Active Differential Probe	ZD200
500 MHz, 1.0 pF, 1 MΩ Active Differential Probe	ZD500
1 GHz, 1.0 pF, 1 MΩ Active Differential Probe	ZD1000
1.5 GHz, 1.0 pF, 1 MΩ Active Differential Probe	ZD1500

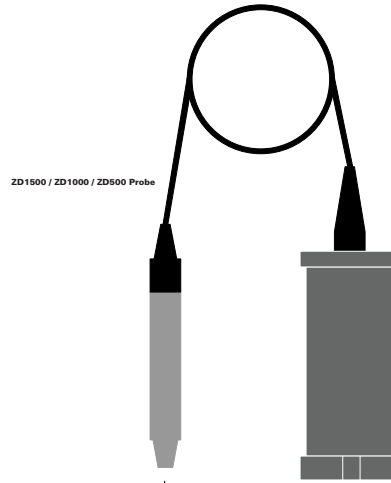

PCF200  
Probe Calibration Fixture

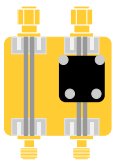

PACC-MS001  
Hands Free Probe Holder

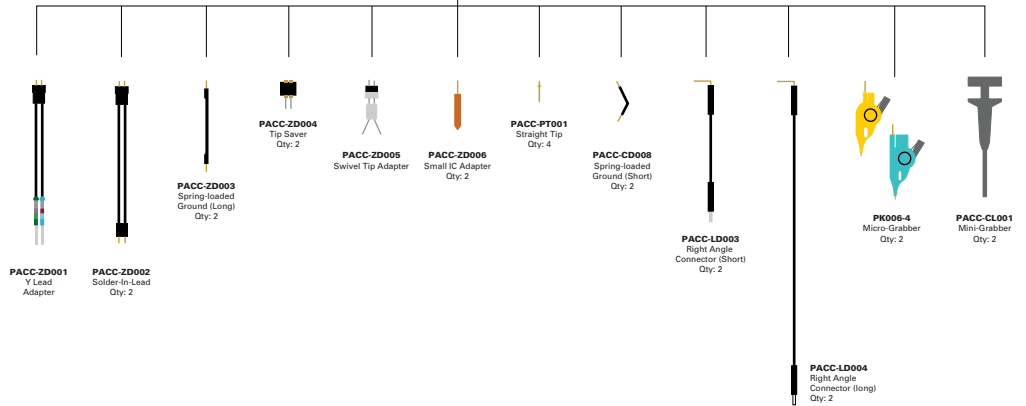
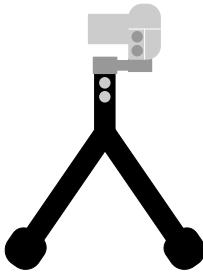

## AP033

High bandwidth, excellent common-mode rejection ratio (CMRR) and low noise make these active differential probes ideal for applications such as disk drive design and failure analysis, as well as wireless and data communication design.



## Specifications

Bandwidth	500 MHz
Gain	x10, x1, ÷10 (÷100 with plug-on ÷10 attenuator)
DC Accuracy	1% in x1 without external attenuator
Input Resistance	1 MΩ each input to ground 2 MΩ differential between inputs
Differential Mode Range	±400 mV (x1) ±40 mV (x10) ±4 V (÷10) ±40 V (÷100)
Offset Range	±400 mV (x1, x10) ±4 V (±10) ±40 V (±100)
Common-Mode Range	±42 V peak (±10) +4.2 V peak (±100)
CMRR	70 Hz 10,000:1 (80 dB) 100 kHz 10,000:1 (80 dB) 1 MHz 1000:1 (60 dB) 10 MHz 100:1 (40 dB) 250 MHz 5:1 (14 dB)

## Ordering Information

### Product Description

500 MHz Differential Probe

### Product Code

AP033

# 4 GHz - 6 GHz DIFFERENTIAL PROBES



Teledyne LeCroy  
4 GHz - 6 GHz  
Differential Probe  
Model Numbers:

**D410-PS**  
**D420-PS**  
**D400A-AT**  
**D610-PS**  
**D620-PS**  
**D600A-AT**

WaveLink® probes provide industry leading technology for wideband signal connection to test instruments. The first differential probes to employ SiGe technology, they deliver full system bandwidth when used with oscilloscopes up to 6 GHz.

WaveLink probes:

- Maintain good loading characteristics across the frequency span
- Optimized for gain, noise and bandwidth for optimal performance
- Offer broad range of dynamic range and noise over gain settings by incorporating automatic probe attenuation changes

WaveLink is the first differential probe to use a unique calibration process to achieve superb waveform fidelity for routine voltage measurements. Calibration coefficients “fine tune” the frequency response of each WaveLink probe and are individually determined during factory calibration and programmed into the probe. The oscilloscopes read this data and use it to digitally compensate the entire system response for superior fidelity.

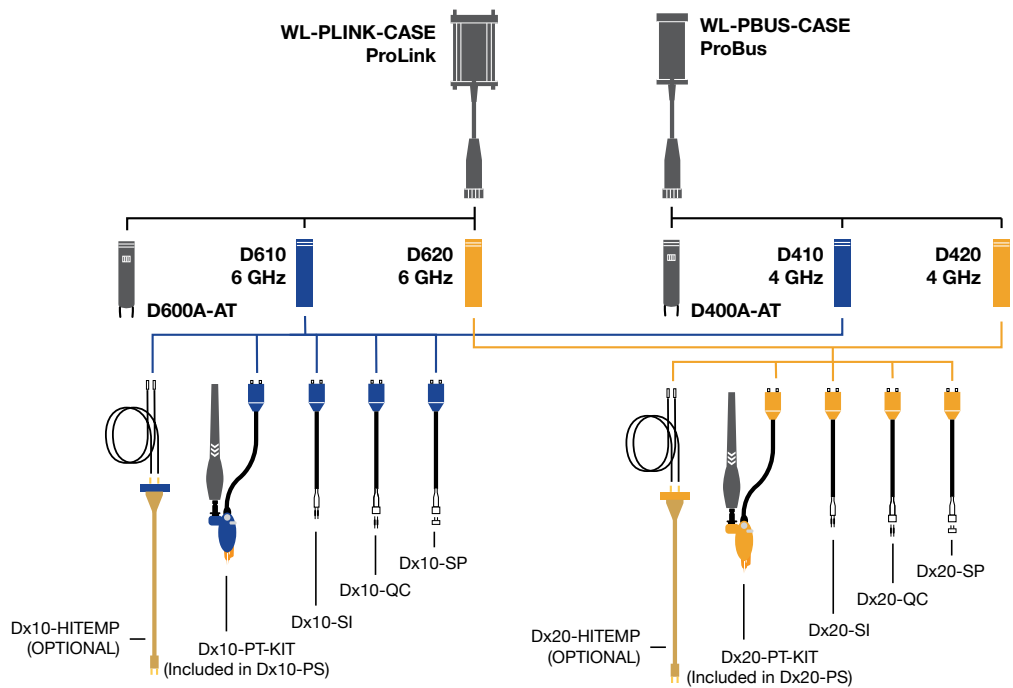



# 4 GHz - 6 GHz DIFFERENTIAL PROBES

	D610, D610-PS	D620, D620-PS	D410, D410-PS	D420, D420-PS	D600A-AT	D400A-AT
<b>Bandwidth* (Probe Only, Guaranteed) (System Bandwidth, Typical)</b>	<b>Dx10-SI and Dx10-PT Tips</b> 6 GHz <b>Dx10-HiTemp</b> 5 GHz <b>Dx10-QC Tip</b> 4 GHz <b>Dx10-SP Tip</b> 3 GHz	<b>Dx20-SI and Dx20-PT Tips</b> 6 GHz <b>Dx20-HiTemp</b> 5 GHz <b>Dx20-QC Tip</b> 4 GHz <b>Dx20-SP Tip</b> 3 GHz	<b>Dx10-SI, Dx10-HiTemp, Dx10-QC and Dx10-PT Tips</b> 4 GHz <b>Dx10-SP Tip</b> 3 GHz	<b>Dx20-SI, Dx20-HiTemp, Dx20-QC and Dx20-PT Tips</b> 4 GHz <b>Dx20-SP Tip</b> 3 GHz	6 GHz	4 GHz
<b>Rise Time* (10–90%)</b>	<b>Dx10-SI and Dx10-PT Tips</b> 75 ps (typical) <b>Dx10-HiTemp</b> 90 ps (typical) <b>Dx10-QC Tip</b> 122.5 ps (typical) <b>Dx10-SP Tip</b> 150 ps (typical)	<b>Dx20-SI and Dx20-PT Tips</b> 75 ps (typical) <b>Dx20-HiTemp</b> 90 ps (typical) <b>Dx20-QC Tip</b> 122.5 ps (typical) <b>Dx20-SP Tip</b> 150 ps (typical)	<b>Dx10-SI, Dx10-HiTemp, and Dx10-PT Tips</b> 112 ps (typical) <b>Dx10-QC Tip</b> 122.5 ps (typical) <b>Dx10-SP Tip</b> 150 ps (typical)	<b>Dx20-SI, Dx20-HiTemp, and Dx20-PT Tips</b> 112 ps (typical) <b>Dx20-QC Tip</b> 122.5 ps (typical) <b>Dx20-SP Tip</b> 150 ps (typical)	<75 ps (typical)	<112 ps (typical)
<b>Rise Time* (20–80%)</b>	<b>Dx10-SI and Dx10-PT Tips</b> 56 ps (typical) <b>Dx10-HiTemp</b> 67.5 ps (typical) <b>Dx10-QC Tip</b> 92 ps (typical) <b>Dx10-SP Tip</b> 113 ps (typical)	<b>Dx20-SI and Dx20-PT Tips</b> 56 ps (typical) <b>Dx20-HiTemp</b> 67.5 ps (typical) <b>Dx20-QC Tip</b> 92 ps (typical) <b>Dx20-SP Tip</b> 113 ps (typical)	<b>Dx10-SI, Dx10-HiTemp, and Dx10-PT Tips</b> 84 ps (typical) <b>Dx10-QC Tip</b> 92 ps (typical) <b>Dx10-SP Tip</b> 113 ps (typical)	<b>Dx20-SI, Dx20-HiTemp, and Dx20-PT Tips</b> 84 ps (typical) <b>Dx20-QC Tip</b> 92 ps (typical) <b>Dx20-SP Tip</b> 113 ps (typical)	56 ps (typical)	84 ps (typical)
<b>Noise (System)</b>	<36 nV/√Hz (2.8 mVrms) (typical) Referred to input, 6 GHz bandwidth	<61 nV/√Hz (4.8 mVrms) (typical) Referred to input, 6 GHz bandwidth	<36 nV/√Hz (2.3 mVrms) (typical) Referred to input, 4 GHz bandwidth	<67 nV/√Hz (4.3 mVrms) (typical) Referred to input, 4 GHz bandwidth	<74 nV/√Hz (5.8 mVrms) (typical) Referred to input, 6 GHz bandwidth	<74 nV/√Hz (4.1 mVrms) (typical) Referred to input, 4 GHz bandwidth
<b>Input</b>						
<b>Input Dynamic Range (Nominal)</b>	2.5Vpk-pk, ±1.25V	5Vpk-pk, ±2.5V	2.5Vpk-pk, ±1.25V	5Vpk-pk, ±2.5V	4.8Vpk-pk, ±2.4V	
<b>Input Common Mode Voltage Range (Nominal)</b>	±4 V				±2.4 Vmax	
<b>Input Offset Voltage Range</b>	±3 V Differential (nominal)				n/a	
<b>Non-destructive Input Range (Nominal)</b>	±20 V				±18 V	
<b>Attenuation</b>	1.7X / 1.0X (nominal)	3.2X / 1.9X (nominal)	1.7X / 1.0X (nominal)	3.2X / 1.9X (nominal)	2.5X	
<b>DC Input Resistance (Nominal)</b>	100 kΩ Differential 50 kΩ Common Mode				4 kΩ Differential 2 kΩ Common Mode	
<b>Impedance (Zmin, Typical)</b>	<b>Dx10-SI Lead, Dx10-HiTemp</b> >175 Ω Differential† <b>Dx10-PT Tip</b> >175 Ω Differential† <b>Dx10-QC Tip</b> >125 Ω Differential† <b>Dx10-SP Tip</b> >40 Ω Differential†	<b>Dx20-SI Lead, Dx20-HiTemp</b> >250 Ω Differential† <b>Dx20-PT Tip</b> >175 Ω Differential† <b>Dx20-QC Tip</b> >125 Ω Differential† <b>Dx20-SP Tip</b> >40 Ω Differential†	<b>Dx10-SI Lead, Dx10-HiTemp</b> >200 Ω Differential† <b>Dx10-PT Tip</b> >175 Ω Differential† <b>Dx10-QC Tip</b> >100 Ω Differential† <b>Dx10-SP Tip</b> >40 Ω Differential†	<b>Dx20-SI Lead, Dx20-HiTemp</b> >350 Ω Differential† <b>Dx20-PT Tip</b> >175 Ω Differential† <b>Dx20-QC Tip</b> >100 Ω Differential† <b>Dx20-SP Tip</b> >40 Ω Differential†	>200 Ω Differential	>450 Ω Differential through entire frequency range

\* All bandwidth and rise time measurements are made with an oscilloscope bandwidth greater or equal to the probe bandwidth  
† Through entire frequency range

## Product Description

### Complete Probe Systems

Product Description	Product Code
4 GHz Complete Probe System with Dx10-SI Solder-In Tip (Qty. 1), Dx10-SP Square Pin (Qty. 1), Dx10-QC Quick Connect (Qty. 1), and Dx10-PT-KIT Positioner Tip Browser (Qty. 1)	D410-PS
4 GHz Complete Probe System with Dx20-SI Solder-In Tip (Qty. 1), Dx20-SP Square Pin (Qty. 1), Dx20-QC Quick Connect (Qty. 1), and Dx20-PT-KIT Positioner Tip Browser (Qty. 1)	D420-PS
6 GHz Complete Probe System with Dx10-SI Solder-In Tip (Qty. 1), Dx10-SP Square Pin (Qty. 1), Dx10-QC Quick Connect (Qty. 1), and Dx10-PT-KIT Positioner Tip Browser (Qty. 1)	D610-PS
6 GHz Complete Probe System with Dx20-SI Solder-In Tip (Qty. 1), Dx20-SP Square Pin (Qty. 1), Dx20-QC Quick Connect (Qty. 1), and Dx20-PT-KIT Positioner Tip Browser (Qty. 1)	D620-PS

### Amplifier and Probe Tip Modules

WaveLink D410 4 GHz/2.5Vp-p Differential Probe Amplifier with Dx10-SI Solder-In Tip (Qty. 1), Dx10-SP Square Pin (Qty. 1), and Dx10-QC Quick Connect (Qty. 1)	D410
WaveLink D420 4 GHz/5Vp-p Differential Probe Amplifier with Dx20-SI Solder-In Tip (Qty. 1), Dx20-SP Square Pin (Qty. 1), and Dx20-QC Quick Connect (Qty. 1)	D420
WaveLink D610 6 GHz/2.5Vp-p Differential Probe Amplifier with Dx10-SI Solder-In Tip (Qty. 1), Dx10-SP Square Pin (Qty. 1), and Dx10-QC Quick Connect (Qty. 1)	D610
WaveLink D620 6 GHz/5Vp-p Differential Probe Amplifier with Dx20-SI Solder-In Tip (Qty. 1), Dx20-SP Square Pin (Qty. 1), Dx20-QC Quick Connect (Qty. 1)	D620

## Product Description

### Amplifier and Probe Tip Modules (cont'd)

Product Description	Product Code
WaveLink D300A-AT 4 GHz/4.8Vp-p Differential Amplifier Module with Adjustable Tip	D400A-AT
WaveLink D600A-AT 6 GHz/4.8Vp-p Differential Amplifier Module with Adjustable Tip	D600A-AT
<b>Positioner Tip (Browser) Kits</b>	
WaveLink Dx10-PT Adjustable Positioner Tip Kit. For use with Dx10 amplifiers.	Dx10-PT-KIT
WaveLink Dx20-PT Adjustable Positioner Tip Kit. For use with Dx20 amplifiers.	Dx20-PT-KIT
<b>Probe Platform/Cable Assemblies and Adapters</b>	
WaveLink ProLink Platform/Cable Assembly Kit with complete soft carrying case for all probe items.	WL-PLINK-CASE
WaveLink ProBus Platform/Cable Assembly Kit with complete soft carrying case for all probe items.	WL-PBUS-CASE

### Hi-Temp Leads

WaveLink Temperature Extension Cables for Dx10. Includes set of Matched 30" High Temperature Cables (Qty. 1) and solder-in lead set (Qty. 1)	Dx10-HiTemp
WaveLink Temperature Extension Cables for Dx20. Includes set of Matched 30" High Temperature Cables (Qty. 1) and solder-in lead set (Qty. 1)	Dx20-HiTemp

# 8 GHz - 13 GHz DIFFERENTIAL PROBES



Teledyne LeCroy  
8 GHz - 13 GHz  
Differential Probe  
Model Numbers:

**D830-PS**

**D1030-PS**

**D1330-PS**

## General Purpose Probe with Range of Capabilities

Teledyne LeCroy's WaveLink 8-13 GHz Differential Probes are a medium bandwidth, general purpose probing solution with high input dynamic range and offset range capability. These probes support solder-in, positioner (browser), square pin and SMA/SMP cabled tip/lead connections. The range of capabilities is ideal for a variety of high speed DDR signals where high dynamic range and large offset requirements are common.

## Features and Benefits

- Choice of 8, 10, or 13 GHz bandwidth models
- 3.5 V<sub>pk-pk</sub> dynamic range
- ±4 V offset range
- Ideal for DDR3, DDR4, LPDDR3
- Deluxe soft carrying case
- Wide variety of tips and leads
  - Solder-In Lead
  - Positioner (Browser) Tip
  - SMA/SMP Lead
  - Square Pin Lead
- SMA/SMP lead set accessory does not require purchase of a different amplifier

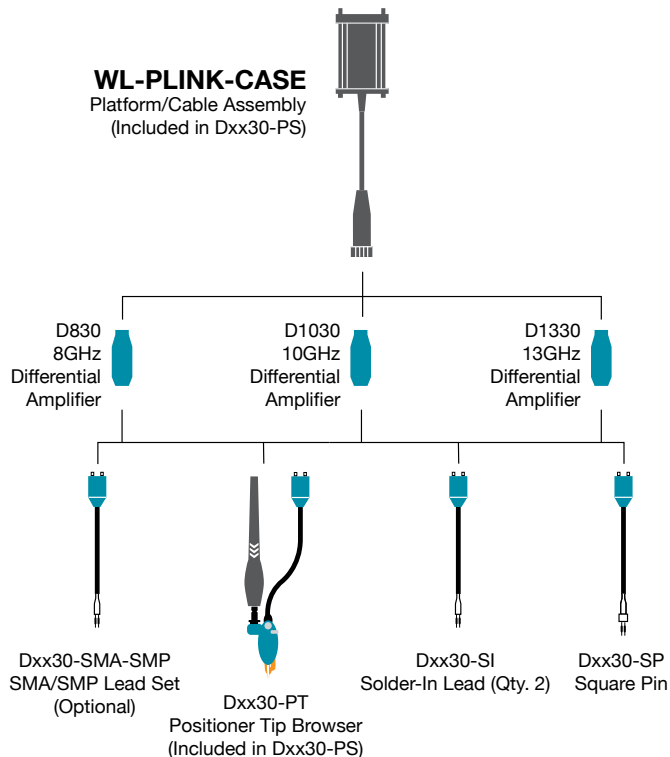

# 8 GHz - 13 GHz DIFFERENTIAL PROBES

	<b>D830, D830-PS</b>	<b>D1030, D1030-PS</b>	<b>D1330, D1330-PS</b>
<b>Bandwidth</b>	<b>Dxx30-SI, Dxx30-SMA-SMP, and Dxx30-PT Tips</b> 8 GHz (probe only, guaranteed) 8 GHz (system bandwidth, when used with 808Zi/Zi-A, typical)  <b>Dxx30-SP Tip</b> 3 GHz (probe only, guaranteed) 3 GHz (system bandwidth, when used with 808Zi/Zi-A, typical)	<b>Dxx30-SI, Dxx30-SMA-SMP, and Dxx30-PT Tips</b> 10 GHz (probe only, guaranteed) 10 GHz (system bandwidth, when used with 813Zi/Zi-A, typical)  <b>Dxx30-SP Tip</b> 3 GHz (probe only, guaranteed) 3 GHz (system bandwidth, when used with 813Zi/Zi-A, typical)	<b>Dxx30-SI and Dxx30-SMA-SMP Tips</b> 13 GHz (probe only, guaranteed) 13 GHz (system bandwidth, when used with 813Zi/Zi-A, typical)  <b>Dxx30-PT Tip</b> 10 GHz (probe only, guaranteed) 10 GHz (system bandwidth, when used with 813Zi/Zi-A, typical)  <b>Dxx30-SP Tip</b> 3 GHz (probe only, guaranteed) 3 GHz (system bandwidth, when used with 813Zi/Zi-A, typical)
<b>Rise Time (10–90%)</b>	<b>Dxx30-SI, Dxx30-SMA-SMP, and Dxx30-PT Tips</b> 50 ps (typical) System rise time measured with $\geq 8$ GHz oscilloscope  <b>Dxx30-SP Tip</b> 132 ps (typical) System rise time measured with $\geq 8$ GHz oscilloscope	<b>Dxx30-SI, Dxx30-SMA-SMP, and Dxx30-PT Tips</b> 40 ps (typical) System rise time measured with $\geq 13$ GHz oscilloscope  <b>Dxx30-SP Tip</b> 132 ps (typical) System rise time measured with $\geq 13$ GHz oscilloscope	<b>Dxx30-SI and Dxx30-SMA-SMP Tips</b> 35 ps (typical) System rise time measured with $\geq 13$ GHz oscilloscope  <b>Dxx30-PT Tip</b> 40 ps (typical) System rise time measured with $\geq 13$ GHz oscilloscope  <b>Dxx30-SP Tip</b> 132 ps (typical) System rise time measured with $\geq 13$ GHz oscilloscope
<b>Rise Time (20–80%)</b>	<b>Dxx30-SI, Dxx30-SMA-SMP, and Dxx30-PT Tips</b> 37.5 ps (typical) System rise time measured with $\geq 8$ GHz oscilloscope  <b>Dxx30-SP Tip</b> 100 ps (typical) System rise time measured with $\geq 8$ GHz oscilloscope	<b>Dxx30-SI, Dxx30-SMA-SMP, and Dxx30-PT Tips</b> 30 ps (typical) System rise time measured with $\geq 13$ GHz oscilloscope  <b>Dxx30-SP Tip</b> 100 ps (typical) System rise time measured with $\geq 13$ GHz oscilloscope	<b>Dxx30-SI and Dxx30-SMA-SMP Tips</b> 26 ps (typical) System rise time measured with $\geq 13$ GHz oscilloscope  <b>Dxx30-PT Tip</b> 30 ps (typical) System rise time measured with $\geq 13$ GHz oscilloscope  <b>Dxx30-SP Tip</b> 100 ps (typical) System rise time measured with $\geq 13$ GHz oscilloscope
<b>Noise (Probe)</b>	<48 nV/ $\sqrt{\text{Hz}}$ (4.3 mVrms) (typical) Referred to input, 8 GHz bandwidth.	<48 nV/ $\sqrt{\text{Hz}}$ (4.8 mVrms) (typical) Referred to input, 10 GHz bandwidth.	<48 nV/ $\sqrt{\text{Hz}}$ (5.5 mVrms) (typical) Referred to input, 13 GHz bandwidth.
<b>Noise (System)</b>	<52 nV/ $\sqrt{\text{Hz}}$ (4.6 mVrms) (typical) Referred to input, 8 GHz bandwidth.	<52 nV/ $\sqrt{\text{Hz}}$ (5.2 mVrms) (typical) Referred to input, 10 GHz bandwidth.	<52 nV/ $\sqrt{\text{Hz}}$ (5.9 mVrms) (typical) Referred to input, 13 GHz bandwidth.

<b>Input</b>	
<b>Input Dynamic Range</b>	3.5Vpk-pk, $\pm 1.75\text{V}$ (nominal)
<b>Input Common Mode Voltage Range</b>	$\pm 5\text{V}$ (nominal)
<b>Input Offset Voltage Range</b>	$\pm 4\text{V}$ Differential (nominal)
<b>Non-destructive Input Range</b>	$\pm 15\text{V}$ (nominal)
<b>Attenuation</b>	3.75x (nominal)
<b>DC Input Resistance (Nominal)</b>	200 k $\Omega$ Differential 50 k $\Omega$ Common mode
<b>Impedance (Zmin, Typical)</b>	>250 $\Omega$ Differential through entire frequency range using SI tip
<b>Impedance (Mid-Band, Typical)</b>	<b>Dxx30-SI Lead</b> 470 $\Omega$ at 4 GHz, 320 $\Omega$ at 6 GHz, 260 $\Omega$ at 8 GHz, 250 $\Omega$ at 9 GHz, 260 $\Omega$ at 10 GHz, 350 $\Omega$ at 13 GHz  <b>Dxx30-PT Tip</b> 155 $\Omega$ at 4 GHz, 210 $\Omega$ at 6 GHz, 140 $\Omega$ at 8 GHz, 80 $\Omega$ at 9 GHz, 40 $\Omega$ at 10 GHz

<b>Product Description</b>	<b>Product Code</b>
<b>Complete Probe Systems</b>	
8 GHz Complete Probe System with Dxx30-SI Solder-In Tip (Qty. 2), Dxx30-SP Square Pin (Qty. 1), and Dxx30-PT-KIT Positioner Tip Browser (Qty. 1)	D830-PS
10 GHz Complete Probe System with Dxx30-SI Solder-In Tip (Qty. 2), Dxx30-SP Square Pin (Qty. 1), and Dxx30-PT-KIT Positioner Tip Browser (Qty. 1)	D1030-PS
13 GHz Complete Probe System with Dxx30-SI Solder-In Tip (Qty. 2), Dxx30-SP Square Pin (Qty. 1), and Dxx30-PT-KIT Positioner Tip Browser (Qty. 1)	D1330-PS
<b>Amplifier and Probe Tip Modules</b>	
WaveLink D830 8 GHz/3.5V <sub>p-p</sub> Differential Probe Amplifier with Dxx30-SI Solder-In Tip (Qty. 2) and Dxx30-SP Square Pin (Qty. 1)	D830
WaveLink D1030 10 GHz/3.5V <sub>p-p</sub> Differential Probe Amplifier with Dxx30-SI Solder-In Tip (Qty. 2) and Dxx30-SP Square Pin (Qty. 1)	D1030
WaveLink D1330 13 GHz/3.5V <sub>p-p</sub> Differential Probe Amplifier with Dxx30-SI Solder-In Tip (Qty. 2) and Dxx30-SP Square Pin (Qty. 1)	D1330

<b>Product Description</b>	<b>Product Code</b>
<b>Positioner Tip (Browser) Kits</b>	
WaveLink Dxx30-PT (up to 10 GHz rating) Adjustable Positioner Tip Kit. For use with Dxx30 amplifiers.	Dxx30-PT-KIT
<b>Probe Platform/Cable Assemblies and Adapters</b>	
WaveLink ProLink Platform/Cable Assembly Kit with complete soft carrying case for all probe items.	WL-PLINK-CASE
<b>SMA/SMP Lead Set</b>	
Lead set consisting of WaveLink Dxx30-SMA-SMP-LEADS for use with Dxx30 amplifiers.	Dxx30-SMA-SMP-LEADS
<b>Accessories</b>	
Cascade Microtech EZ-Probe Positioner	EZ PROBE
Probe Deskw and Calibration Test Fixture	TF-DSQ
<b>Calibration Options</b>	
NIST Calibration for D830. Includes test data.	D830-CCNIST
NIST Calibration for D1030. Includes test data.	D1030-CCNIST
NIST Calibration for D1330. Includes test data.	D1330-CCNIST

# 13 GHz - 25 GHz DIFFERENTIAL PROBES



Teledyne LeCroy  
13 GHz - 25 GHz  
Differential Probe  
Model Numbers:

**D1305-A-PS**  
**D1605-A-PS**  
**D2005-A-PS**  
**D2505-A-PS**

## Ultra-wideband Architecture for Superior Signal Fidelity

Teledyne LeCroy's WaveLink® high bandwidth differential probes utilize advanced differential traveling wave (distributed) amplifier architecture to achieve superior high frequency true analog broadband performance. Traveling wave (distributed) amplifiers are commonly used in ultra high frequency broadband amplifiers. This multi-stage amplifier architecture maximizes gain per stage and minimizes probe attenuation, which provides very low probe noise and fast rise times.

## Features & Benefits

- Up to 25 GHz bandwidth (probe + oscilloscope)
- System rise time as fast as 13 ps (20–80%)
- 25 GHz Solder-in solution
- 22 GHz ultra-compact browser tip
- Superior probe impedance minimizes AC loading on device under test (DUT)
- Carbon-composite browser tips optimize signal fidelity and minimize loading
- Probe noise as low as 14 nV/√Hz (1.6 mV<sub>rms</sub>)
- Low probe attenuation
- Large operating voltage range
  - ±4 V common mode range
  - ±2.5 V offset range
  - 2.0 V<sub>pk-pk</sub> dynamic range
- Long length Solder-In tip with field replaceable resistors

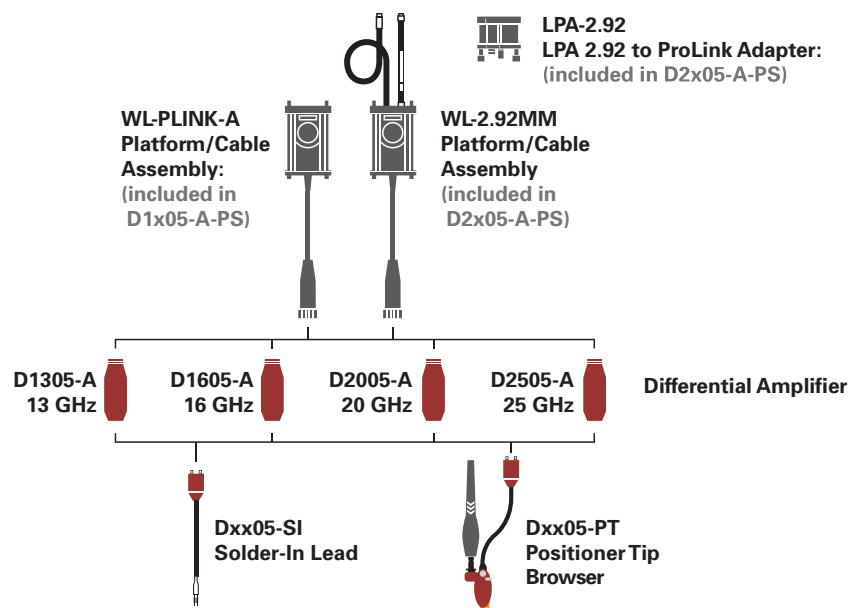

# 13 GHz - 25 GHz DIFFERENTIAL PROBES

	D1305-A, D1305-A-PS	D1605-A, D1605-A-PS	D2005-A, D2005-A-PS	D2505-A, D2505-A-PS
<b>Bandwidth</b>	<b>Dxx05-SI and Dxx05-PT Tips</b> 13 GHz (probe only, guaranteed) 13 GHz (system bandwidth, when used with 813Zi, typical)	<b>Dxx05-SI and Dxx05-PT Tips</b> 16 GHz (probe only, guaranteed) 16 GHz (system bandwidth, when used with 816Zi, typical)	<b>Dxx05-SI and Dxx05-PT Tips</b> 20 GHz (probe only, guaranteed) 20 GHz (system bandwidth, when used with 820Zi, typical)	<b>Dxx05-SI Lead</b> 25 GHz (probe only, guaranteed) 25 GHz (system bandwidth, when used with 825Zi, typical) <b>Dxx05-PT Tip</b> 22 GHz (system bandwidth, when used with 825Zi, typical) 20 GHz (probe only, guaranteed)
<b>Rise Time (10–90%)</b>	<b>Dxx05-SI and Dxx05-PT Tips</b> 32.5 ps (typical) System rise time measured with $\geq 13$ GHz oscilloscope	<b>Dxx05-SI and Dxx05-PT Tips</b> 28 ps (typical) System rise time measured with $\geq 16$ GHz oscilloscope	<b>Dxx05-SI and Dxx05-PT Tips</b> 20 ps (typical) System rise time measured with $\geq 20$ GHz oscilloscope	<b>Dxx05-SI Lead</b> 17.5 ps (typical) System rise time measured with $\geq 25$ GHz oscilloscope <b>Dxx05-PT Tip</b> 19 ps (typical) System rise time measured with $\geq 25$ GHz oscilloscope
<b>Rise Time (20–80%)</b>	<b>Dxx05-SI and Dxx05-PT Tips</b> 24.5 ps (typical) System rise time measured with $\geq 13$ GHz oscilloscope	<b>Dxx05-SI and Dxx05-PT Tips</b> 21 ps (typical) System rise time measured with $\geq 16$ GHz oscilloscope	<b>Dxx05-SI and Dxx05-PT Tips</b> 15 ps (typical) System rise time measured with $\geq 20$ GHz oscilloscope	<b>Dxx05-SI Lead</b> 13 ps (typical) System rise time measured with $\geq 25$ GHz oscilloscope <b>Dxx05-PT Tip</b> 14 ps (typical) System rise time measured with $\geq 25$ GHz oscilloscope
<b>Noise (Probe)</b>	< 14 nV/ $\sqrt{\text{Hz}}$ (1.6 mV <sub>rms</sub> ) (typical) Referred to input, 13 GHz bandwidth	< 14 nV/ $\sqrt{\text{Hz}}$ (1.8 mV <sub>rms</sub> ) (typical) Referred to input, 16 GHz bandwidth	< 18 nV/ $\sqrt{\text{Hz}}$ (2.5 mV <sub>rms</sub> ) (typical) Referred to input, 20 GHz bandwidth	< 18 nV/ $\sqrt{\text{Hz}}$ (2.8 mV <sub>rms</sub> ) (typical) Referred to input, 25 GHz bandwidth
<b>Noise (System)</b>	< 23 nV/ $\sqrt{\text{Hz}}$ (2.7 mV <sub>rms</sub> ) (typical) Referred to input, 13 GHz bandwidth	< 23 nV/ $\sqrt{\text{Hz}}$ (2.9 mV <sub>rms</sub> ) (typical) Referred to input, 16 GHz bandwidth	< 28 nV/ $\sqrt{\text{Hz}}$ (4.0 mV <sub>rms</sub> ) (typical) Referred to input, 20 GHz bandwidth	< 28 nV/ $\sqrt{\text{Hz}}$ (4.5 mV <sub>rms</sub> ) (typical) Referred to input, 25 GHz bandwidth

<b>Input</b>				
<b>Input Dynamic Range</b>	2.0 V <sub>pk-pk</sub> ( $\pm 1.0$ V) (nominal)			
<b>Input Common Mode Voltage Range</b>	$\pm 4$ V (nominal)			
<b>Input Offset Voltage Range</b>	$\pm 2.5$ V Differential (nominal)			
<b>Non-destructive Input Range</b>	$\pm 10$ V (nominal)			
<b>Attenuation</b>	3.5x (nominal)		4.5x (nominal)	
<b>DC Input Resistance (Nominal)</b>	1.1 k $\Omega$ Differential 100 k $\Omega$ Common mode			
<b>Impedance (Z<sub>min</sub>, typical)</b>	<b>Dxx05-SI Lead</b> > 300 $\Omega$ Differential through entire frequency range <b>Dxx05-PT Tip</b> > 160 $\Omega$ Differential through entire frequency range	<b>Dxx05-SI Lead</b> > 300 $\Omega$ Differential through entire frequency range <b>Dxx05-PT Tip</b> > 160 $\Omega$ Differential through entire frequency range	<b>Dxx05-SI Lead</b> > 230 $\Omega$ Differential through entire frequency range <b>Dxx05-PT Tip</b> > 160 $\Omega$ Differential through entire frequency range	<b>Dxx05-SI Lead</b> > 120 $\Omega$ Differential through entire frequency range <b>Dxx05-PT Tip</b> > 160 $\Omega$ Differential through entire frequency range
<b>Impedance (mid-band, typical)</b>	<b>Dxx05-SI Lead:</b> 300 $\Omega$ at 6 GHz, 525 $\Omega$ at 13 GHz, 600 $\Omega$ at 16 GHz, 300 $\Omega$ at 20 GHz, 120 $\Omega$ at 25 GHz <b>Dxx05-PT Tip:</b> 160 $\Omega$ at 6 GHz, 450 $\Omega$ at 13 GHz, 240 $\Omega$ at 16 GHz, 210 $\Omega$ at 20 GHz			

Product Description	Product Code
<b>Complete Probe Systems</b>	
13 GHz Complete Probe System with Solder-In Tip (13 GHz) and Positioner Tip Browser (13 GHz)	D1305-A-PS
16 GHz Complete Probe System with Solder-In Tip (16 GHz) and Positioner Tip Browser (16 GHz)	D1605-A-PS
20 GHz Complete Probe System with Solder-In Tip (20 GHz) and Positioner Tip Browser (20 GHz)	D2005-A-PS
25 GHz Complete Probe System with Solder-In Tip (25 GHz) and Positioner Tip Browser (22 GHz)	D2505-A-PS
<b>Amplifier and Probe Tip Modules</b>	
WaveLink D1305 13 GHz/1.6 V <sub>pk-pk</sub> Differential Probe Amplifier with Dxx05-SI Solder-In Tip (Qty. 2)	D1305-A
WaveLink D1605 16 GHz/1.6 V <sub>pk-pk</sub> Differential Probe Amplifier with Dxx05-SI Solder-In Tip (Qty. 2)	D1605-A
WaveLink D2005 20 GHz/1.6 V <sub>pk-pk</sub> Differential Probe Amplifier with Dxx05-SI Solder-In Tip (Qty. 2)	D2005-A
WaveLink D2505 25 GHz/1.6 V <sub>pk-p</sub> Differential Probe Amplifier with Dxx05-SI Solder-In Tip (Qty. 2)	D2505-A
<b>Positioner Tip (Browser) Kits</b>	
WaveLink Dxx05-PT (Up to 22 GHz Rating) Adjustable Positioner Tip Kit. For use with Dxx05 Amplifiers	Dxx05-PT-KIT
<b>Probe Platform/Cable Assemblies and Adapters</b>	
WaveLink ProLink Platform/Cable Assembly Kit for $\geq 13$ GHz WaveLink Probes	WL-PLINK-A-CASE
WaveLink 2.92 mm Platform/Cable Assembly Kit for $\geq 20$ GHz WaveLink Probes	WL-2.92MM-CASE
ProLink to 2.92 mm Adapter with Probe Power and Communication Pass Through	LPA-2.92

Product Description	Product Code
<b>Accessories</b>	
Cascade Microtech EZ-Probe Positioner	EZ PROBE
Probe Deskew and Calibration Test Fixture	TF-DSQ
<b>Calibration Options</b>	
NIST Calibration for D1305. Includes Test Data	D1305-A-CCNIST
NIST Calibration for D1605. Includes Test Data	D1605-A-CCNIST
NIST Calibration for D2005. Includes Test Data	D2005-A-CCNIST
NIST Calibration for D2505. Includes Test Data	D2505-A-CCNIST
<b>Replacement Parts</b>	
Replacement Dxx05-SI 13–25 GHz Solder-In Lead with Qty. 5 Spare Resistors	Dxx05-SI
Replacement SI Resistor Kit for Dxx05-SI Solder-In Tip	Dxx05-SI-RESISTORS
Replacement Dxx05-PT Positioner Tip	Dxx05-PT
Qty. 4 Replacement Carbon Composite Pogo-pin Tips	Dxx05-PT-TIPS
Replacement Probe Tip Holder Kit	PK600ST-3
Replacement Platform/Cable Assembly Mounting Kit	PK600ST-4
Qty. 1 Package of Black Adhesive Pads (10/pkg.) and Qty. 1 Package of White Adhesive Pads (10/pkg.)	Dxx05-PT-TAPE
Qty. 1 Package of Adhesive Probe Connection Guides (200 individual guides/package)	Dxx05-PT-GUIDES

# HIGH VOLTAGE DIFFERENTIAL PROBES



**Differential active probes are like two probes in one. Instead of measuring a test point in relation to a ground point (like single-ended active probes), differential probes measure the difference in voltage of a test point in relation to another test point.**

Teledyne LeCroy  
High Voltage  
Differential Probe  
Model Numbers:

**HVD3102**

**HVD3106**

**HVD3106-6M**

**ADP300**

**ADP305**

*Opposite page:  
HVD3000 Series High Voltage Differential Probes  
working with an HDO8000*

# HIGH VOLTAGE DIFFERENTIAL PROBES

Teledyne LeCroy  
High Voltage  
Differential Probe  
Model Numbers:

HVD3102

HVD3106

HVD3106-6M



The HVD3000 high voltage differential probes provide high CMRR over a broad frequency range to simplify the measurement challenges found in noisy, high common-mode power electronics environments. The probe's design is easy-to-use and enables safe, precise high voltage floating measurements.

## Features

- Differential voltage measurement capability up to 1000 Vrms
- Exceptional common-mode rejection ratio (CMRR) across a broad frequency range
- Wide differential voltage range of 1500 Vp-p, 2000 Vp-p before saturation for capture of short duration overshoots
- High offset capability at both high and low attenuation
- 1% DC and low frequency gain accuracy
- ProBus active probe interface with automatic scaling
- Auto-zero capabilities



# HIGH VOLTAGE DIFFERENTIAL PROBES

Specifications	HVD3102	HVD3106	HVD3106-6M
Bandwidth	25 MHz	120 MHz	80 MHz
Rise Time (10-90)	14 ns	2.9 ns	4.4 ns
Differential Voltage Range	<b>High Attenuation</b> 1500 V (DC + peak AC) from 7 to 400 V/div with up to 1500 V offset. 2000 V maximum typical measurable differential voltage before saturation <b>Low Attenuation</b> 27.6 V (DC + peak AC) from 100 mV/div to 6.9 V/div with up to 150 V offset.		
Common Mode Voltage Range	±1500 V (DC + peak AC), 1000 V <sub>rms</sub> (CAT III) (either input to ground)		
Maximum Input Voltage to Earth	1000 V <sub>rms</sub> (CAT III) (either input to ground)		
Max Safe Input	1000 V <sub>rms</sub> CAT III		
Sensitivity	100 mV/div to 6.9V/div (100X) 7V/div to 400V/div (1000X)	100 mV/div to 6.9V/div (50X) 7V/div to 400V/div (500X)	100 mV/div to 6.9V/div (50X) 7V/div to 400V/div (500X)
Gain Accuracy	1% (LF, guaranteed)		
Slew Rate	100 V/ns (maximum)	400 V/ns (maximum)	400 V/ns (maximum)
Attenuation	100x / 1000x	50x / 500x	50x / 500x
Input Impedance	10 MΩ    2.5 pF (between inputs), 5 MΩ    5.0 pF (either input to ground)		
Input Coupling	DC only		
Output Coupling	AC, DC, GND		
Output Termination	1 MΩ		
Interface	ProBus		
Input Lead Length	40 cm input lead length		
Cable Length (input lead to oscilloscope connection)	2.25 m		6.80 m

## Noise and Rejection

CMRR (Typical)	DC - 60 Hz: 80 dB 1 MHz: 65 dB 5 MHz: 40 dB 20 MHz: 30 dB	DC - 60 Hz: 80 dB 1 MHz: 65 dB 5 MHz: 40 dB 20 MHz: 30 dB 100 MHz: 30 dB	DC - 60 Hz: 80 dB 1 MHz: 65 dB 5 MHz: 40 dB 20 MHz: 30 dB 80 MHz: 30 dB
Noise (Probe)	100X: <15 mV <sub>rms</sub> 1000X: <85 mV <sub>rms</sub> (referred to input)	50X: <30 mV <sub>rms</sub> 500X: <150 mV <sub>rms</sub> (referred to input)	50X: <30 mV <sub>rms</sub> 500X: <150 mV <sub>rms</sub> (referred to input)

## Environmental

Temperature (Operating)	0°C to 50°C
Temperature (Non-Operating)	-40°C to 70°C
Humidity (Operating)	5% to 80% RH (Non-Condensing) up to 30°C, decreasing linearly to 50% RH at 50°C
Humidity (Non-Operating)	5% to 95% RH (Non-Condensing), 75% RH above 30°C, 45% RH above 40°C
Altitude (Operating)	2,000 m maximum (3,000 m maximum at 25°C)
Altitude (Non-Operating)	10,000 m
Pollution Degree	2, Indoor use only

## Ordering Information

Product Description	Product Code
25 MHz, High Voltage Differential Probe	HVD3102
120 MHz, High Voltage Differential Probe	HVD3106
80 MHz, High Voltage Differential Probe with 6m cable	HVD3106-6M
High Voltage Replacement Accessories Kit (Includes 2 each, 1 Black, 1 Red): Safety Alligator Clips, Plunger Pincer Clips, Plunger Hook Clips, Plunger Alligator Clips, Spade Terminals	PK-HV-001
Safety Alligator Clips (Quantity 2 - 1 Black, 1 Red)	PK-HVA-01
Plunger Pincer Clips (Quantity 2 - 1 Black, 1 Red)	PK-HVA-02
Plunger Hook Clips (Quantity 2 - 1 Black, 1 Red)	PK-HVA-03
Plunger Alligator Clips (Quantity 2 - 1 Black, 1 Red)	PK-HVA-04
Spade Terminals (Quantity 2 - 1 Black, 1 Red)	PK-HVA-05

# HIGH VOLTAGE DIFFERENTIAL PROBES

Teledyne LeCroy  
High Voltage  
Differential Probes  
Model Numbers:

AP031  
ADP300  
ADP305



The AP031 is a low cost, battery operated active differential probe intended for measuring higher voltages. The differential techniques employed permit measurements to be taken at two points in a circuit without reference to the ground, allowing the oscilloscope to be safely grounded without the use of opto-isolators or isolating transformers.

## Features

- Safe floating measurements
- 15 MHz bandwidth
- 700 V maximum input voltage
- Works with any 1 M $\Omega$  input oscilloscope

## AP031 Specifications

Attenuation	$\div 10 / \div 100$
Bandwidth	15 MHz
Input R	4 M $\Omega$
Differential Mode Range	$\pm 70$ V / $\pm 700$ V DC + Peak AC
Common Mode Range	$\pm 700$ V DC + Peak AC
CMRR	86 dB @ 50 Hz 56 dB @ 200 kHz

Power Requirements: four AA batteries

## Ordering Information

Product Description	Product Code
700 V, 15 MHz Differential Probe ( $\div 10, \div 100$ )	AP031
1,400 V, 20 MHz High-Voltage Differential Probe	AP300
1,400 V, 100 MHz High-Voltage Differential Probe	AP305

# HIGH VOLTAGE DIFFERENTIAL PROBES

ADP30X high-voltage active probes are safe, easy-to-use, and ideally suited for measuring power electronics. The ADP300 is designed for troubleshooting low-frequency power devices and other circuits where the reference potential is elevated from the ground or the location of the ground is unknown. The ADP305 is designed for measuring the high-speed floating voltages found in today's power electronics.



## Features

- 20 MHz and 100 MHz bandwidth
- 1,000 V<sub>rms</sub> common mode voltage
- 1,400 V<sub>peak</sub> differential voltage
- EN 61010 CAT III
- 80 dB CMRR at 50/60 Hz
- ProBus system
- Full remote control

## ADP30X Specifications

### Electrical Characteristics

Bandwidth	20 MHz (ADP300) 100 MHz (ADP305)
Differential Voltage	1,400 V peak
Common Mode Voltage	1,000 V rms CAT III
Low-Frequency Accuracy (Probe Only)	1% of Reading
CMRR	50/60 Hz 80 dB (10,000:1) 100 kHz 50 dB (300:1)
Max. Slew Rate (Referenced to Input)	60,000 V/μs (ADP300) 300,000 V/μs (ADP305)
AC Noise (Referenced to Input)	50 mV rms
Attenuation	÷100/÷1000 (automatically selected by scope)
Input Impedance	Between inputs 8 MΩ, 6 pF Each input to ground 4 MΩ, 1 pF
Sensitivity	1 V/div to 350 V/div (ADP300) 200 mV/div to 350 V/div (ADP305)
Interface	ProBus, 1 MΩ*

### General Characteristics

Overall Length	2 m
Input Connectors	4 mm Shrouded Banana Plug
Operating Temperature	0 °C to 50 °C
Warranty	1 year

\*Requires AP-1M for oscilloscopes with 50 Ω only inputs

# DIFFERENTIAL AMPLIFIERS

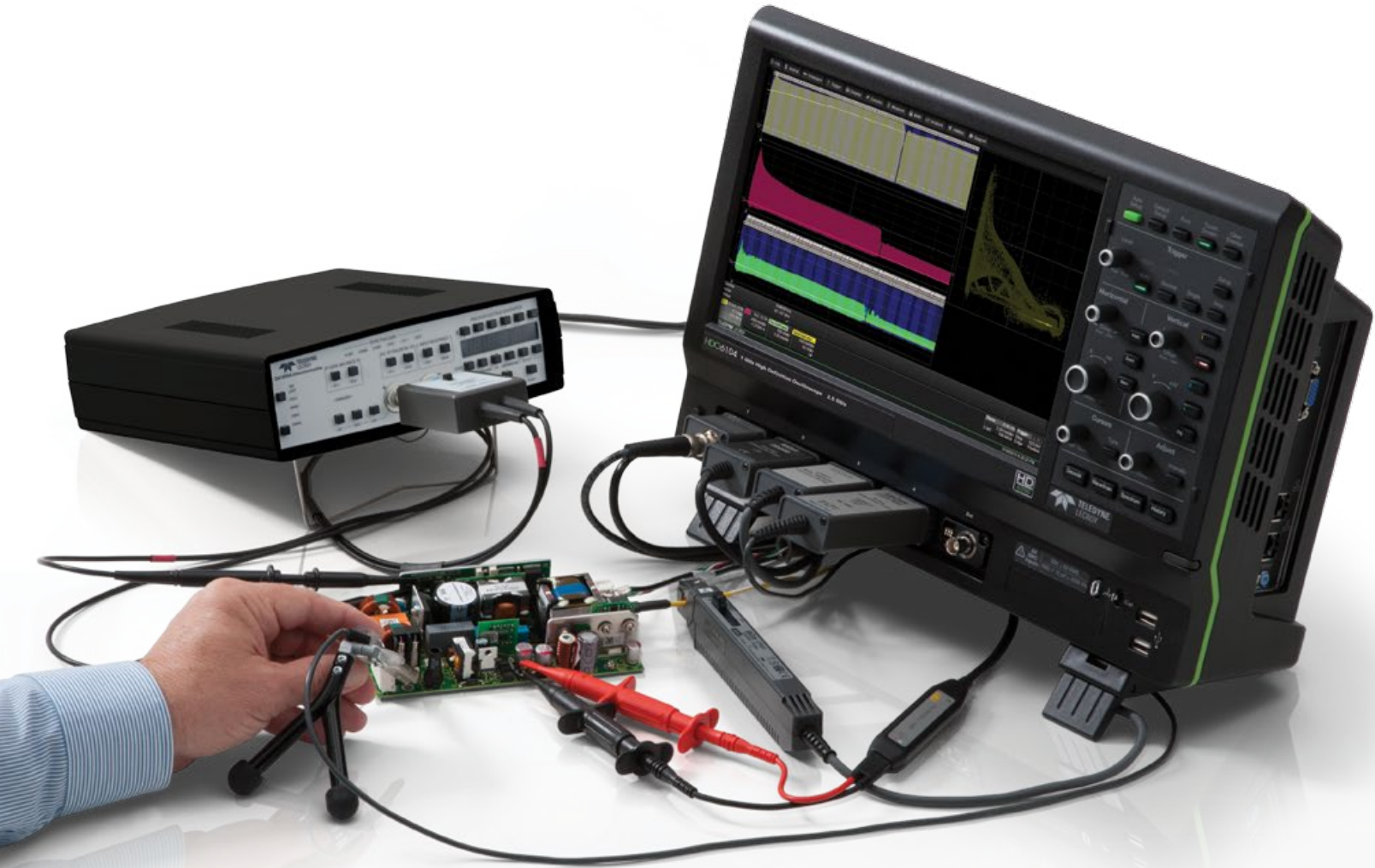

**Differential amplifiers are intended to act as signal conditioning preamplifiers for oscilloscopes and network and spectrum analyzers, providing differential measurement capability to instruments having only a single-ended input. The “-PR2” version of each amplifier is a dual channel unit. The DXC series differential input cables are matched to the characteristics of the amplifier.**

Teledyne LeCroy  
Differential Amplifier  
and Accessory  
Model Numbers:

DA1855A  
DA1855-PR2  
DA1855A-RM  
DA1855A-PR2-RM  
DXC5100  
DXC100A  
DXC200  
DA101

*Opposite page:  
DA1855A Differential Amplifier working with the  
HD06000 oscilloscope for power measurement.*

# DIFFERENTIAL AMPLIFIERS

Teledyne LeCroy  
Differential Amplifier  
and Accessory  
Model Numbers:

DA1855A  
DA1855-PR2  
DA1855A-RM  
DA1855A-PR2-RM  
DXC5100  
DXC100A  
DXC200  
DA101



## DA1855A

The DA1855A is a stand-alone, high-performance 100 MHz differential amplifier. It is intended to act as a signal conditioning preamplifier for oscilloscopes, digitizers and spectrum analyzers, providing differential measurement capability to instruments having only a single-ended input. When used with a DA1855A, oscilloscopes can obtain Common Mode Rejection Ratio (CMRR) and overdrive recovery performance levels previously unobtainable.

Amplifier gain can be set to 1 or 10. A built-in input attenuator can be separately set to attenuate signals by a factor of 10, providing gains of 10, 1, or 0.1 and common mode dynamic range of  $\pm 15.5 \text{ V} (\div 1)$  or  $\pm 155 \text{ V} (\div 10)$ . Optional probes increase the maximum input signal and common mode ranges

in proportion to their attenuation ratio but do not exceed their maximum input voltage rating. Effective gain of the DA1855A, including probe attenuation, amplifier gain and attenuator settings, is automatically displayed.

The DA1855A features a built-in Precision Voltage Generator (PVG) that can be set to any voltage between  $\pm 15.5 \text{ V}$  ( $\pm 10 \text{ V}$  in Differential Offset) with up to  $100 \mu\text{V}$  resolution. The PVG's output can be selected as an input to the inverting (-) input of the amplifier for operation as a differential comparator, or applied internally as a true differential offset voltage independent of oscilloscope offset. The differential amplifier is also available in a 2 channel model. In addition, a rackmount is available for each model for easy installation with other instruments.



## DXC100A

÷100 or ÷10 Selectable, 250 MHz Passive Differential Probe Pair

- DC to 100 MHz Bandwidth with DA1855A  
DC to 10 MHz Bandwidth with DA1822
- Max Input Voltage 500 V
- Selectable 10 or 100 Attenuation Factor
- 1.2 m Cable Length



## DXC200

÷1, 50 MHz, Passive Differential Probe Pair

- DC to 50 MHz with DA1855A  
DC to 10 MHz with DA1822A
- Max Input Voltage 500 V (Limited to Amplifier Max Input Voltage)
- x1 Differential Probe Pair
- 0.7 m Cable Length



## DXC5100

÷100, 2.5KV Passive High Voltage Probe Pair. Requires DA101 for full performance



## DA101

÷10, 1MΩ Passive Attenuator for DXC series probes

## Ordering Information

### Product Description

Product Description	Product Code
1 Ch, 100 MHz Differential Amplifier with Precision Voltage Source	DA1855A
2 Ch, 100 MHz Differential Amplifier with Precision Voltage Source	DA1855A-PR2
DA1855A with Rackmount	DA1855A-RM
DA1855A with Rackmount (must be ordered at time of purchase, no retrofit)	DA1855A-PR2-RM
÷100 or ÷10 Selectable, 250 MHz Passive Differential Probe Pair	DXC100A*
÷1, 50 MHz Passive Differential Probe Pair	DXC200*
÷100, 250 MHz 2.5 kV, High Voltage Probe Pair (requires DA101 for full performance)	DXC-5100*
÷10 1 MΩ Passive Attenuator for DXC Series Probes	DA101*

\*Must be used with DA Series Differential Amplifiers

# HIGH VOLTAGE PROBES

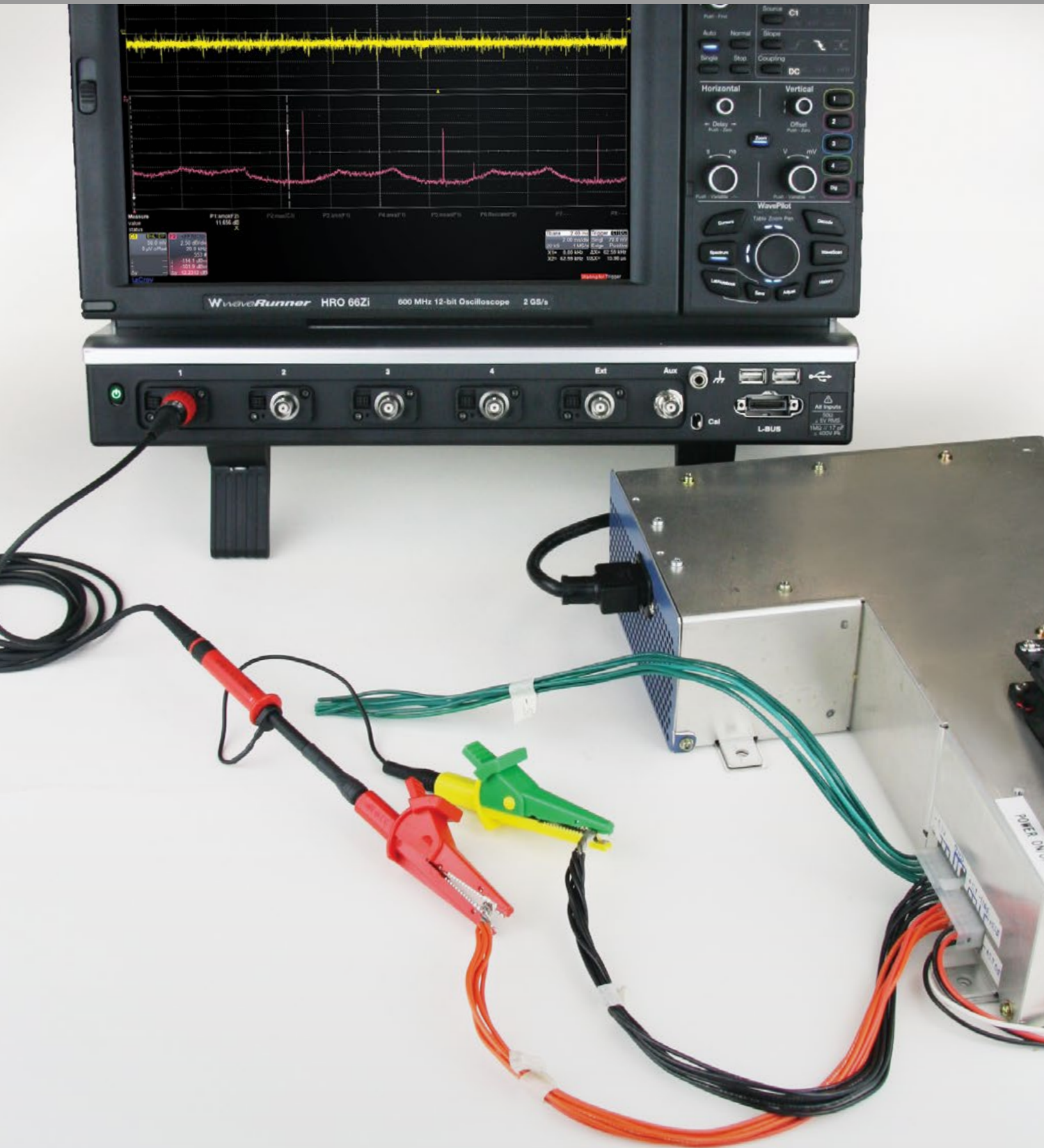



High voltage probes are suitable for a wide range of applications where high-voltage measurements must be made safely and accurately. There are several fixed attenuation probes covering a range from 1 kV to 6 kV and varying transient overvoltage ratings. All of these high voltage probes feature a spring loaded probe tip and a variety of standard accessories to make probing high voltages safe and easy. Additionally, all of the high voltage probe have a probe sense pin to automatically configure the oscilloscope for use with the probe.

Teledyne LeCroy  
High Voltage Probe  
Model Numbers:

HVP120  
PPE1.2KV  
PPE2KV  
PPE4KV  
PPE5KV  
PPE6KV

*Opposite page:  
PPE Series High Voltage Probe*

Teledyne LeCroy  
High Voltage Probe  
Model Number:  
**HVP120**



The HVP120 is a high voltage passive probe designed for probing up to 1,000 Vrms and capable of handling up to 6,000 V peak transients. Its fast rise time and excellent frequency response make it suitable for a wide variety of high voltage measurement applications. The HVP120 features a spring loaded probe tip and a variety of standard accessories to make probing high voltages safe and easy.

## Features

- 400 MHz probe bandwidth
- 900 ps rise time
- 1000 Vrms maximum input
- Up to 6 kV transient overvoltage

## Electrical Characteristics

Bandwidth	400 MHz
Risetime (10% - 90%)	900 ps (typical)
Maximum Input Voltage*	
Measurement Category II	1000 Vrms
Measurement Category I	4000V Transient Overvoltage at 1000 Vrms 6000V Transient Overvoltage at 0 Vrms
Pollution Degree*	2
Input Capacitance	7.5 pF (typical)
Compensation Range	10 pF - 50 pF (typical)
Attenuation Ratio	100:1 ± 2%

## Environmental

Temperature (Operating)	0°C to 50°C
Temperature (Non-Operating)	-40°C to 71°C
Humidity (Operating)	80% RH (Non-Condensing) up to 31°C, decreasing linearly to 40% RH at 50°C
Altitude (Operating)	up to 2,000 m
Altitude (Non-Operating)	up to 15,000 m

## General Characteristics

Weight (probe)	67 g (0.15 lbs)
Cable Length	2 m (6.56 ft)
Probe Tip Diameter	5 mm (0.20 inches)

\* As defined in IEC 61010-031

**Typical Voltage Derating HVP120  
Measurement Category I**

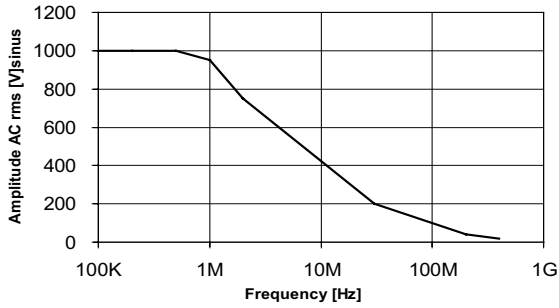

**HVP120 RMS vs. Peak Pulse Voltage  
Measurement Category I**

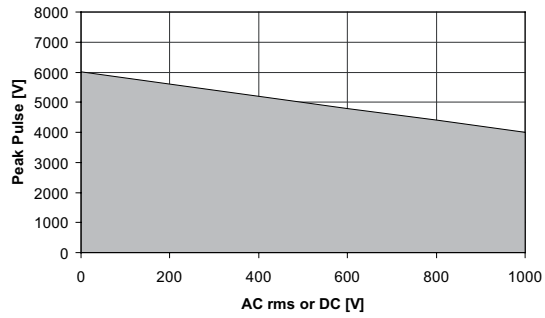

## Product Description

400 MHz, High Voltage Passive Probe  
High Voltage Replacement Accessories Kit

## Product Code

HVP120  
PK-HV-002

## Replacement Accessories

One of each of the following accessories are included with the HVP120. Replacement quantities are listed below.

Coding Rings (set) 4 Colors (Qty 3 also included standard)	PK1-5MM-106
Ground Lead 22 cm to 4 mm Banana plug (Qty 1)	PK1-5MM-122
Solid Tip 0.8 mm (Qty 5)	PK1-5MM-125
Spring Tip 0.8 mm (Qty 5)	PK1-5MM-126
BNC Adapter 5.0-L (Qty 1)	PK1-5MM-127
Insulating Cap 5.0-L (Qty 1)	PK1-5MM-128
Protection Cap 5.0-L (Qty 1)	PK1-5MM-129
Sprung Hook 5.0-L (Qty 1)	PK1-5MM-130
Adjustment Tool T (Qty 1)	PK1-5MM-131
Flexible Adapter 5.0-L (Qty 1)	PK1-5MM-132
Safety Alligator Clip red (Qty 1)	PK1-5MM-133
Ground Lead 22 cm (Qty 1)	PK1-5MM-134

# HIGH VOLTAGE PROBES

Teledyne LeCroy  
High Voltage Probe  
Model Numbers:

PPE1.2KV

PPE2KV

PPE4KV

PPE5KV

PPE6KV



The PPE series includes four fixed-attenuation probes covering a range from 2 kV to 6 kV, and one switchable probe providing  $\div 10/\div 100$  attenuation for voltage inputs up to 1.2 kV. All fixed-attenuation, standard probes automatically rescale compatible Teledyne LeCroy oscilloscopes for the appropriate attenuation of the probe.

## Features

- Safe, accurate high-voltage measurement
- 1.2 kV to 6 kV

## High-Voltage Probes Selection Guide Specifications

Types	Bandwidth (MHz)	Input R ( $\Omega$ )	Input C (pF)	Attenuation	Maximum Voltage	Probe Encoding	Cable
PPE1.2kV*	400	50 M	< 6	$\div 10 / \div 100$	600 V/1.2 kV	No	2 m
PPE2kV*	400	50 M	< 6	$\div 100$	2 kV	Yes	2 m
PPE4kV*	400	50 M	< 6	$\div 100$	4 kV	Yes	2 m
PPE5kV*	400	50 M	< 6	$\div 100$	5 kV	Yes	2 m
PPE6kV*	400	50 M	< 6	$\div 1000$	6 kV	Yes	2 m

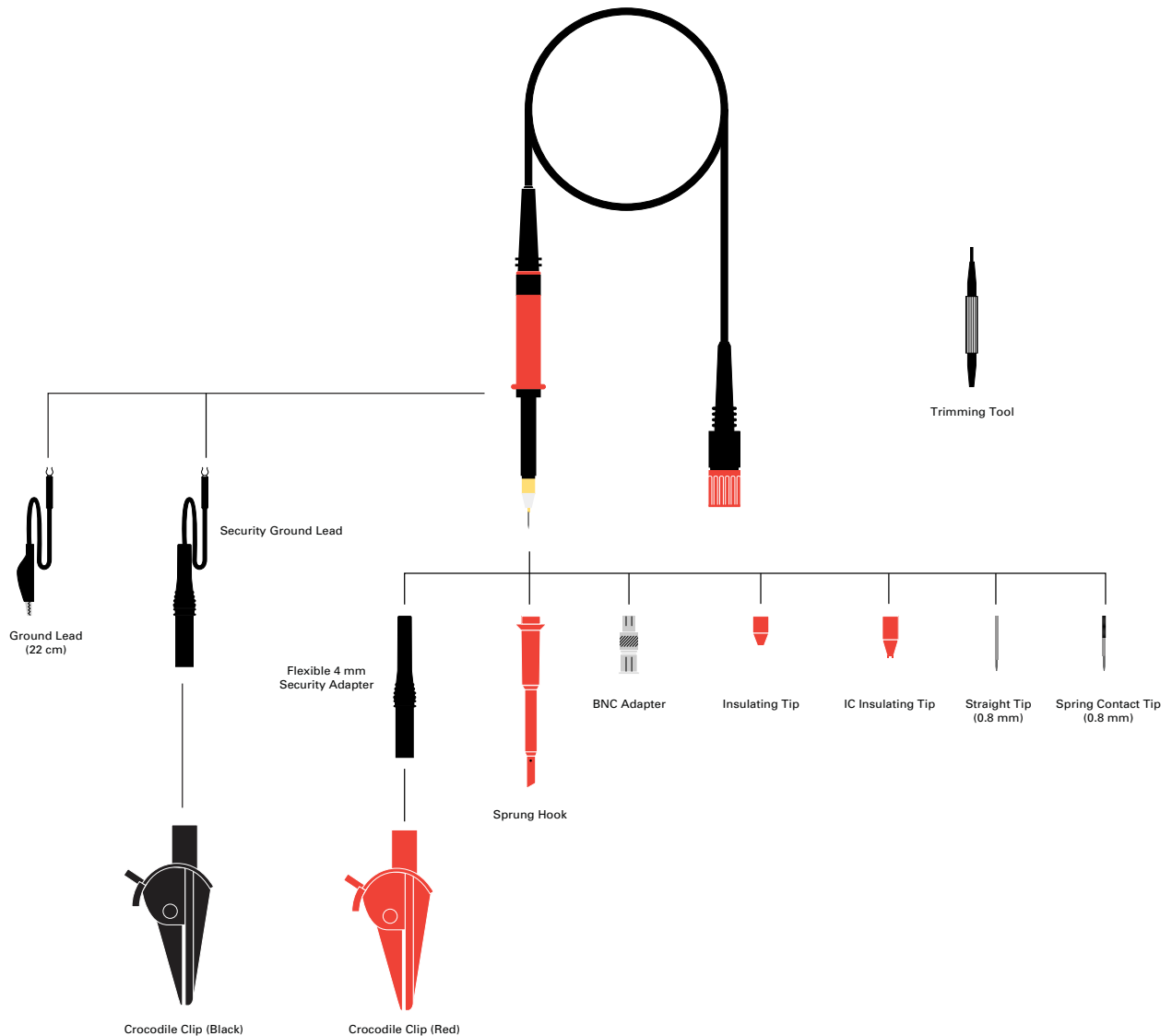

## Ordering Information

### Product Description

### Product Code

÷10/÷100; 200/300 MHz; 5 MΩ/50 MΩ High-Voltage Probe, 600 V/1.2 kV max. Voltage DC	PPE1.2KV
÷100; 400 MHz; 50 MΩ High-Voltage Probe, 2 kV max. Voltage DC and Peak AC	PPE2KV
÷100; 400 MHz; 50 MΩ High-Voltage Probe, 4 kV max. Voltage DC and Peak AC	PPE4KV
÷100; 400 MHz; 50 MΩ High-Voltage Probe, 5 kV max. Voltage DC and Peak AC	PPE5KV
÷1000; 400 MHz; 50 MΩ High-Voltage Probe, 6 kV max. Voltage DC and Peak AC	PPE6KV
Accessory Kit for PPE1.2kV, 2kV, 4kV, 5kV, and 6kV	PK103
Sprung Hook (red)	PK103-1
Ground Lead (22 cm)	PP005-GL22
Crocodile Clip	PK30x-2
Probe Tip to BNC Adapter	PP005-BNC
Spring Tip (0.8 mm)	PP005-ST8
Rigid Tip V2A	PP005-RT

### Supplied with probe:

\* Probe Kit: Trimming tool, ground lead, rigid tip, IC insulator, BNC adapter, tip insulator, sprung hook, red crocodile clip, 4 mm safety ground lead, and green/yellow crocodile clip.

# OPTICAL PROBES

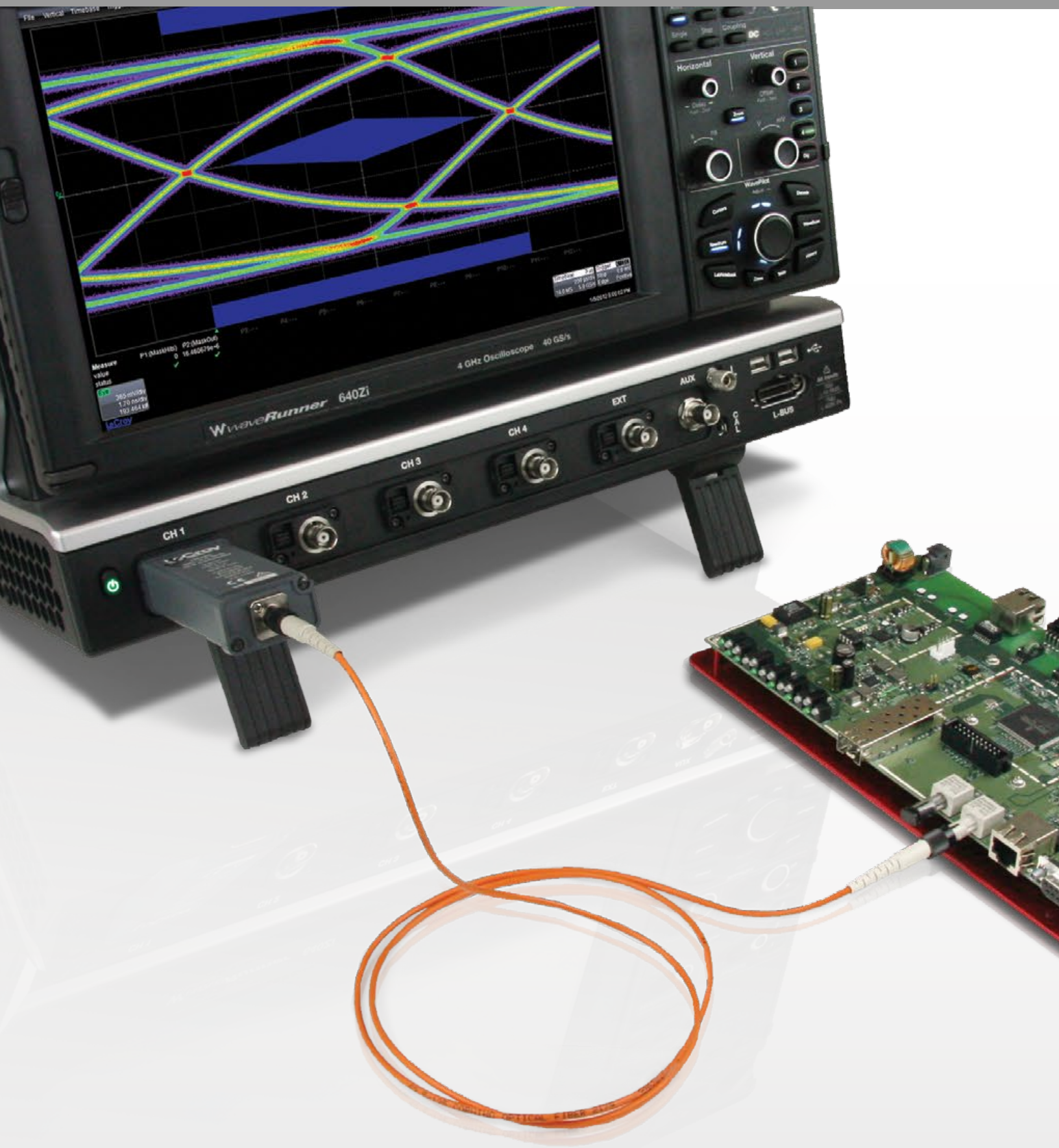

Teledyne LeCroy's wide-band multi-mode optical-to-electrical converters are designed for measuring optical communications signals. Their broad wavelength range and multi-mode input optics make these devices ideal for applications including Ethernet, Fibre Channel, and ITU telecom standards. Available to support optical data rates up to 11.3 Gb/s with reference receivers, or slightly higher without reference receivers.

These wide- band multi-mode optical-to-electrical converters are designed for measuring optical communications signals. They connect to Teledyne LeCroy real-time oscilloscopes and provide capability for physical layer signal assessment using a variety of oscilloscope tools, such as SDAIII-CompleteLinQ Serial Data Eye, Jitter, Noise and Crosstalk Analysis, mask testing, serial triggering and decoding, and other compliance and debug tools. Maximum data rate test capability is >11.317 Gb/s with reference receiver, or 12.5 Gb/s without.

Teledyne LeCroy  
Optical Probe  
Model Numbers:

OE695G

OE425

OE455

OE525

OE555

*Opposite page:  
OE455 Optical Probe working with a WaveRunner 640 Zi oscilloscope.*



Teledyne LeCroy  
Optical Probe  
Model Numbers:

**OE695G**  
**OE425**  
**OE455**  
**OE525**  
**OE555**

## OE695G

Teledyne LeCroy's OE695G wide-band optical-to-electrical converter is ideal for measuring optical datacom and telecom signals with data rates from 622 Mb/s to 12.5+ Gb/s. Connection to a real-time Teledyne LeCroy oscilloscope is through the 2.92mm interface, with a provided adapter to connect to ProLink interfaces.

### Features

- Compatible with Teledyne LeCroy WavePro 7 Zi/Zi-A, WaveMaster 8 Zi/Zi-A, LabMaster 9 Zi-A, and LabMaster 10 Zi oscilloscopes
- Frequency range DC to 9.5 GHz (electrical, -3 dB)
- Reference receiver support from 8GFC to 10GFC FEC, or Custom (<12.5Gb/s)
- Full bandwidth mode (no reference receiver applied)
- 62.5/125  $\mu\text{m}$  multi-mode or single-mode fiber input
- +7 dBm (5 mW) max peak optical power
- Low noise (as low as 25 pW/ $\sqrt{\text{Hz}}$ )
- Ideal for Eye Mask, Extinction Ratio, and Optical Modulation Amplitude (OMA) testing

### Specifications

Optical Wavelength Range	780 to 1550 nm (calibrated range) 750 to 1650 nm (usable range)
Maximum Modulation Bandwidth	DC to 8.625 GHz (-3 dBe, electrical) DC to 11.64 GHz (-3 dBo, optical) (Reference Receiver Applied) DC to 9.5 GHz (-3 dBe) DC to 12 GHz (-6 dBe) DC to 17 GHz (-14 dBe) (+/-1 dBe passband variations typical, no Reference Receiver Applied)
Reference Receiver Uncertainty	$\pm 1.6$ dBe up to Fref = 0.75*bit rate $\pm 4$ dBe 2*Fref setting (typical) $\pm 0.85$ dBe up to Fref = 0.75*bit rate $\pm 4$ dBe 2*Fref setting (on matched oscilloscope input channel 4 with 11, 17, 20, 30, 39, 50, 75, 90, or 100 mV/div gain ranges) with purchase of OE695G-REFCAL)
Reference Receiver Settings	8GFC, OC192/STM64,10GBASE-W,10GBASE-R, 10GFC, ITU-T G.975 FEC, ITU-T G.709 FEC, 10GbE FEC, 10GFC FEC, Custom (622 Mb/s to 12.5 Gb/s), None (Maximum Bandwidth)
Noise Equivalent Power	25 pW/ $\sqrt{\text{Hz}}$ @ 1310 nm (typical) 50 pW/ $\sqrt{\text{Hz}}$ @ 850 nm (typical) Average noise spectral density 0-10 GHz using most sensitive vertical scale
Rise Time (10-90%)	33 ps (typical, no reference receiver applied)
Connector Type	FC/PC, compatible with 62.5/125 $\mu\text{m}$ Multi-Mode fiber, or mechanically compatible Single-Mode fiber
Maximum Optical Linear Input (1 dB Compression Point)	-2 dBm (typical), -3 dBm (minimum) at 1550/1310 nm +4 dBm (typical), +3 dBm (minimum) at 850 nm
Maximum Optical Power	+7 dBm (5 mW) Peak
Conversion Gain (typical)	0.17 V/mW (785 nm) 0.21 V/mW (850 nm) 0.33 V/mW (1310 nm) 0.33 V/mW (1550 nm)



## OE425/OE455/OE525/OE555

The O/E converters contain calibration data that can be used to create optical reference receivers for SONET/SDH (up to OC48/STM16), Fibre Channel, Gigabit Ethernet, and other optical standards. This feature is available when the O/E is used on a supported oscilloscope. The universal reference receiver supports any data rate up to 3 GHz and remains calibrated on any channel of the oscilloscope.



### Features

- Frequency range to 5 GHz (6 GHz optical)
- 62.5  $\mu\text{m}$  or narrower multi-mode or single-mode fiber input
- Broad wavelength range:
  - 500–870 nm (OE425, OE525)
  - 950–1630 nm (OE455, OE555)
- High responsivity
- Low noise
- Included Accessories:
  - Multi-mode optical fiber jumper FC-FC
  - FC to ST adapter
  - FC to SC adapter

### Specifications

	OE425/OE525	OE455/OE555
Wavelength Range	500 – 870 nm 460 – 870 nm (0.1 V/mW)	950 – 1630 nm 800 – 1630 nm (0.1 V/mW)
Conversion Gain	0.5 V/mW	1.1 V/mW
Bandwidth	5 GHz (6 GHz optical)	3.5 GHz (4.5 GHz optical)
Equivalent Noise	2.2 $\mu\text{W}$ rms	1.0 $\mu\text{W}$ rms
Maximum Optical Power (at 5% Saturation)	2.2 mW	1.0 mW
Rise Time	90 ps	108 ps
Maximum Safe Input	5.5 mW	2.5 mW
Temperature Drift	0.00275 dB / °C	0.00275 dB / °C
Frequency Response Ripple	1.1 dB	1.1 dB
Connector Type	FC/PC	FC/PC

### Ordering Information

#### Product Description

#### Product Code

Optical-to-Electrical Converter, 785 to 1550 nm, 2.92 mm connector with ProLink adapter	OE695G
Optical-to-Electrical Converter, 500–870 nm ProBus BNC Connector	OE425
Optical-to-Electrical Converter, 950–1630 nm ProBus BNC Connector	OE455
Optical-to-Electrical Converter, 500–870 nm ProLink BMA Connector	OE525
Optical-to-Electrical Converter, 950–1630 nm ProLink BMA Connector	OE555

# PASSIVE PROBES

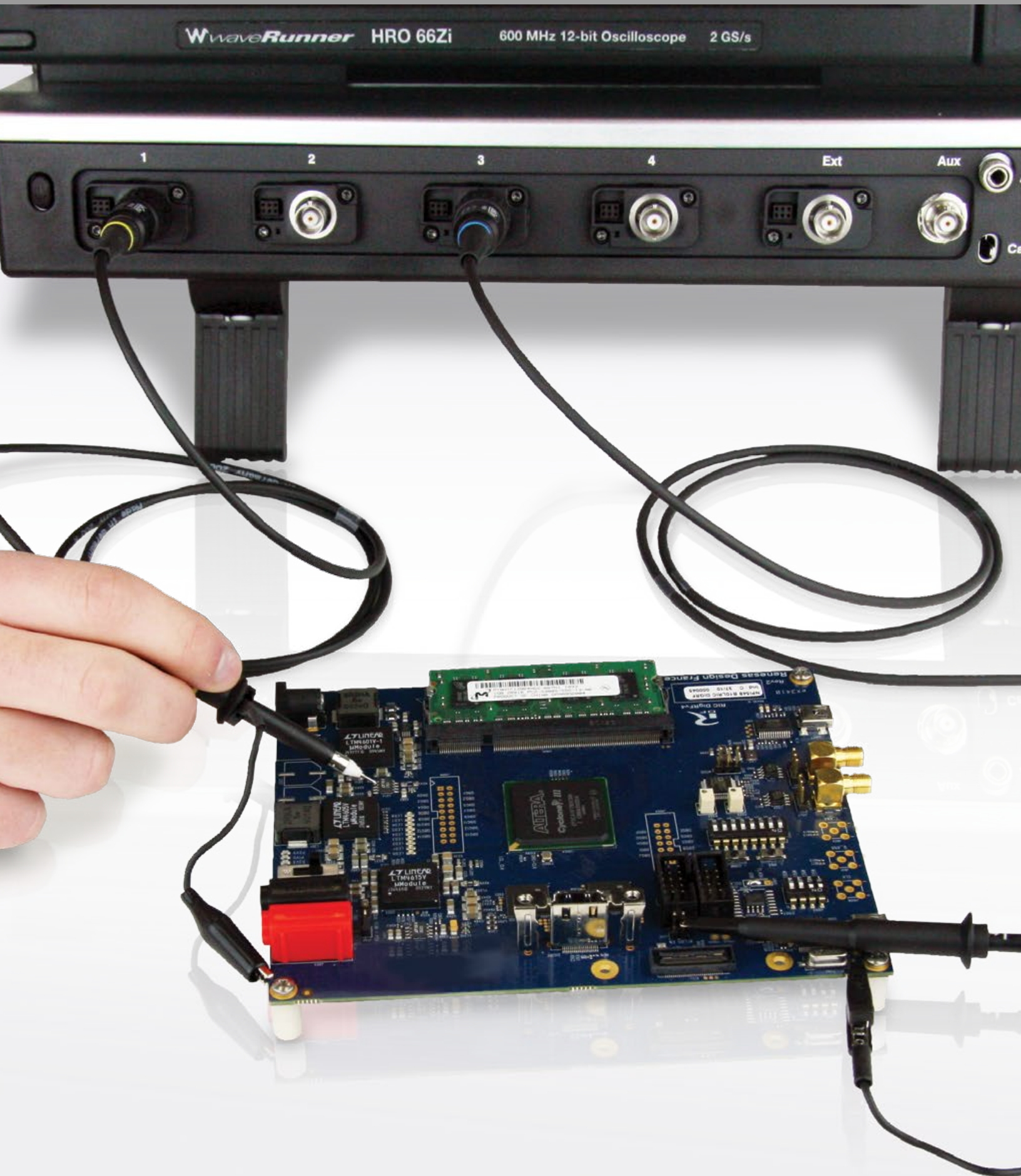

Passive probes are the standard probe provided with most oscilloscopes. Typical passive probes provide a  $\div 10$  attenuation and feature a high input resistance of 10 M $\Omega$ . This high input resistance means that passive probes are the ideal tool for low frequency signals since circuit loading at these frequencies is minimized. Passive probes are designed to handle voltages of at least 400 V, some as high as 600 V. Teledyne LeCroy passive probes feature an attenuation sense pin which tells the oscilloscope to scale the waveforms automatically requiring no user input.

Teledyne LeCroy  
Passive Probe  
Model Numbers:

PP006A  
PP007-WR  
PP008  
PP009  
PP010  
PP011  
PP016  
PP017  
PP018  
PP019  
PP020

# PASSIVE PROBES



Teledyne LeCroy  
Passive Probe  
Model Numbers:

PP006A  
PP007-WR  
PP008  
PP009  
PP010  
PP011  
PP016  
PP017  
PP018  
PP019  
PP020

Each passive probe is recommended for a certain oscilloscope, using the right passive probe with the right oscilloscope means that the probe can be properly compensated across the entire bandwidth. Using probes with a different oscilloscope will only let you compensate for low frequencies.

## Features

- Bandwidth from 200 MHz to 500 MHz
- Probe encoding ring for automatic scale factor readout on Teledyne LeCroy oscilloscopes

## Specifications

Types	Bandwidth	Input R	Input C	Attenuation	Maximum Voltage	Diameter
PP006A	500 MHz	10 M $\Omega$	12 pF	$\div 10$	600 V	5 mm
PP007-WR	500 MHz	10 M $\Omega$	9.5 pF	$\div 10$	400 V	2.5 mm
PP008	500 MHz	10 M $\Omega$	9.5 pF	$\div 10$	400 V	2.5 mm
PP009	500 MHz	10 M $\Omega$	9.5 pF	$\div 10$	400 V	2.5 mm
PP010	500 MHz	10 M $\Omega$	9.5 pF	$\div 10$	400 V	2.5 mm
PP011	50 MHz	10 M $\Omega$	9.5 pF	$\div 10$	400 V	5 mm
PP016	300 MHz/ 10 MHz	10 M $\Omega$ / 1 M $\Omega$	12 pF/ 46 pF	$\div 10$ / $\div 1$	600 V	5 mm
PP017	200 MHz	10 M $\Omega$	12 pF	$\div 10$	600 V	5 mm
PP018	500 MHz	10 M $\Omega$	10 pF	$\div 10$	600 V	5 mm
PP019	200 MHz	10 M $\Omega$	12 pF	$\div 10$	500 V	5 mm
PP020	500 MHz	10 M $\Omega$	11 pF	$\div 10$	500 V	5 mm

## Ordering Information

Product Description	Product Code
$\div 10$ , 500 MHz 10 M $\Omega$ Passive Probe	PP006A
$\div 10$ , 500 MHz 10 M $\Omega$ Passive Probe	PP007-WR
$\div 10$ , 500 MHz 10 M $\Omega$ Passive Probe	PP008
$\div 10$ , 500 MHz 10 M $\Omega$ Passive Probe	PP009
$\div 10$ , 200 MHz 10 M $\Omega$ Passive Probe	PP010
$\div 10$ , 500 MHz 10 M $\Omega$ Passive Probe	PP011
$\div 10$ , 300 MHz 10 M $\Omega$ Passive Probe	PP016
$\div 10$ , 250 MHz 10 M $\Omega$ Passive Probe	PP017
$\div 10$ , 500 MHz 10 M $\Omega$ Passive Probe	PP018
$\div 10$ , 200 MHz 10 M $\Omega$ Passive Probe	PP019
$\div 10$ , 500 MHz 10 M $\Omega$ Passive Probe	PP020

## Passive Probe Accessories for PP009, and PP011 Series

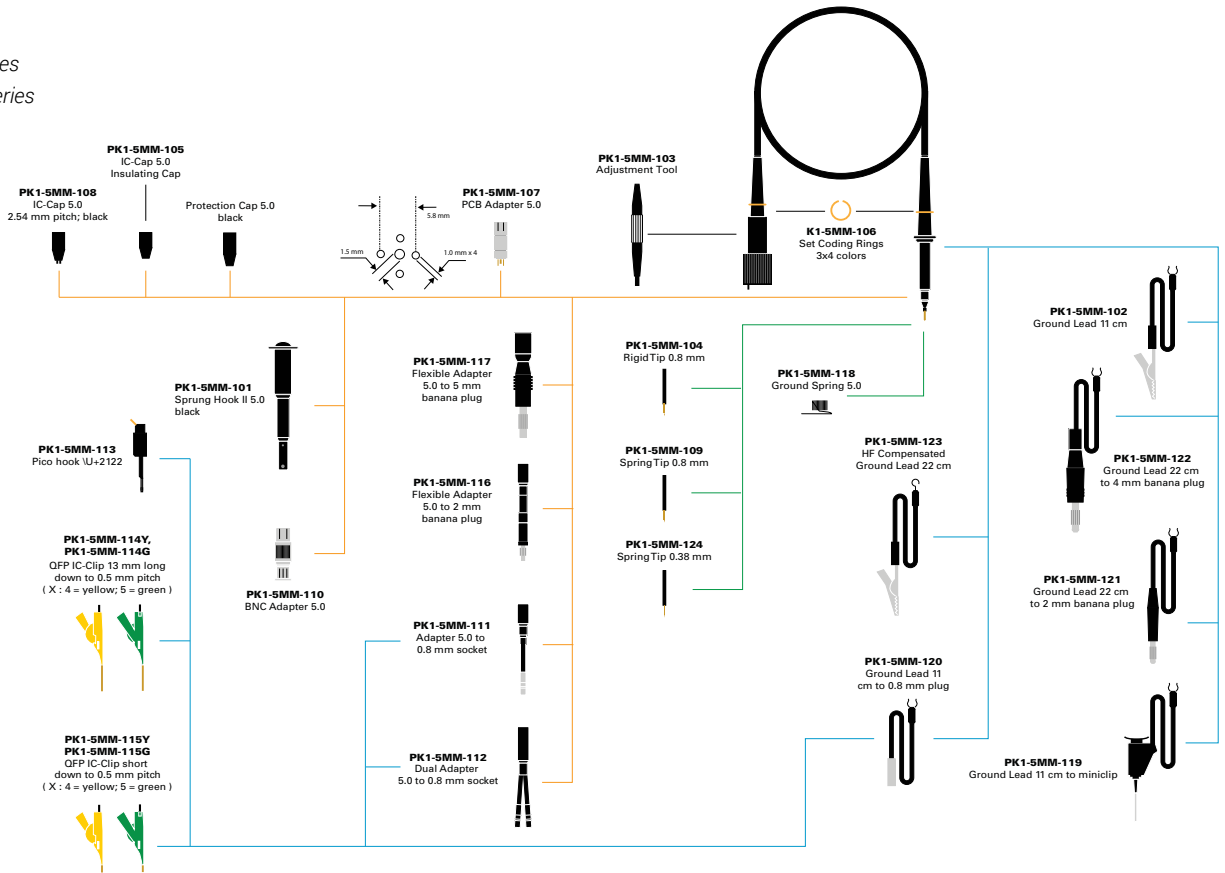

## Passive Probe Accessories for PP007 and PP008 Series

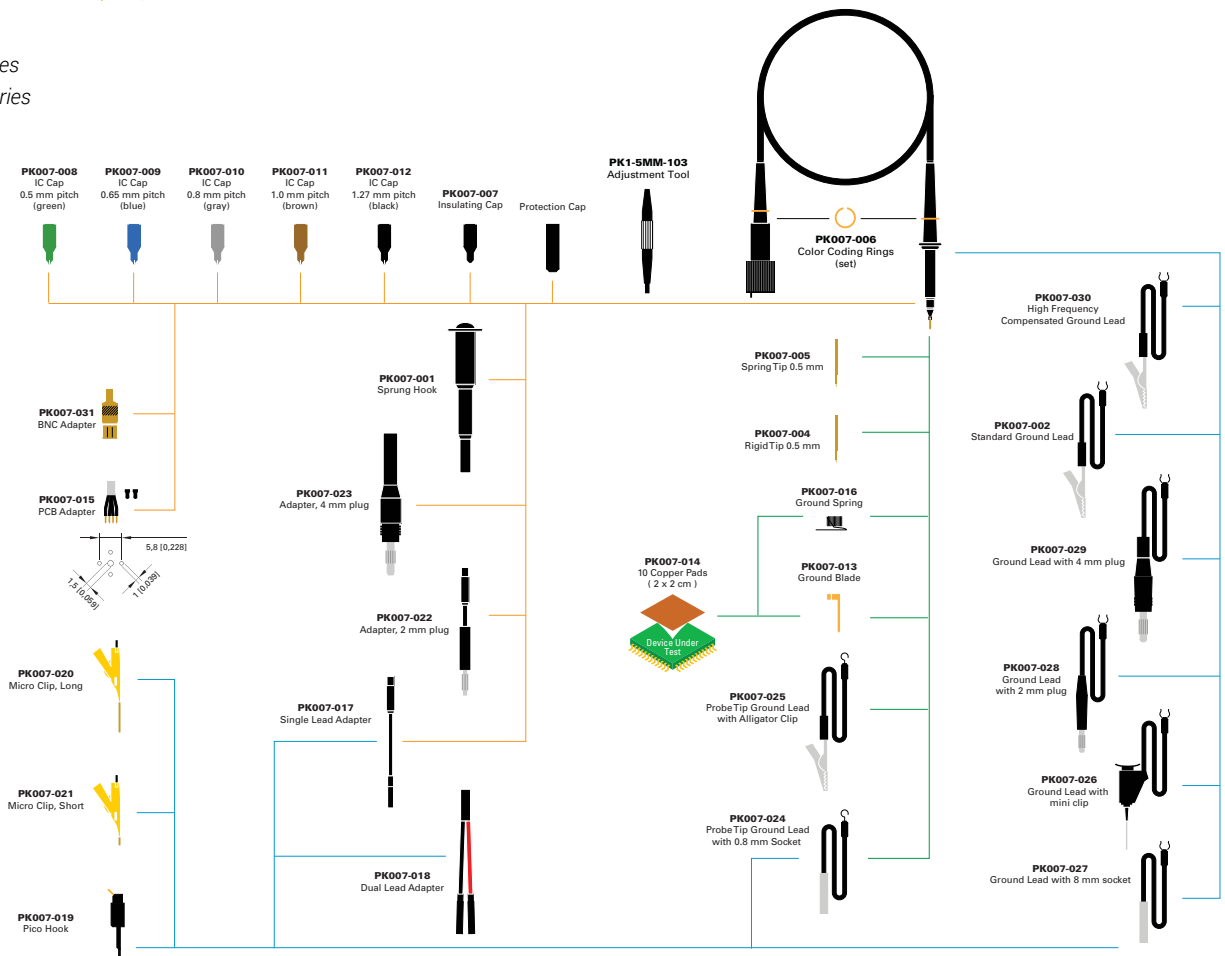

# TRANSMISSION LINE PROBES

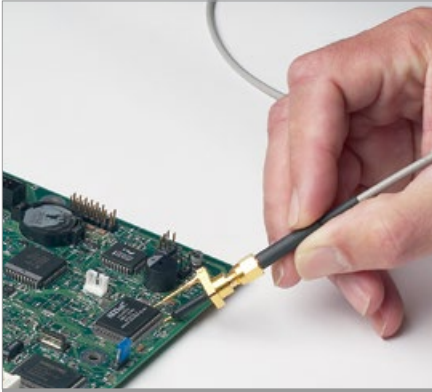

Teledyne LeCroy  
Transmission Line Probe  
Model Number:  
PP066

Transmission line probes are a special type of passive probe designed for use at very high frequencies. They replace the high impedance probe cable found in a traditional passive probe with a precision transmission line, with a characteristic impedance that matches the oscilloscope input ( $50 \Omega$ ). This greatly reduces the input capacitance to a fraction of a picofarad, minimizing the loading of high frequency signals. A matching network at the tip increases the DC input resistance. While they have lower DC input resistance than a traditional passive probe (usually  $500 \Omega$  to  $5 \text{ k}\Omega$ ), the input impedance of these probes remains nearly constant over their entire frequency range. A traditional  $\div 10$  passive probe will have a  $10 \text{ M}\Omega$  input impedance at DC, however this impedance drops rapidly with frequency, passing below the input impedance of a transmission line probe at less than 100 MHz.

In some applications, transmission line probes offer advantages over active probes. In addition to being less expensive, their passive design is more robust to over voltage and ESD exposure. They are useful in applications producing fast rising, narrow pulses with amplitudes which exceed the dynamic range of active probes. They also tend to have less parasitic effects on frequency response.

## PP066

The PP066 is a high-bandwidth passive probe designed for use with the WaveMaster and other high-bandwidth oscilloscopes with 50  $\Omega$  input termination. This very low capacitance probe provides an excellent solution for higher frequency applications, especially the probing of transmission lines with 20–100  $\Omega$  impedance. The PP066 accommodates a wide range of applications, including probing of analog and digital ICs commonly found in computer, communications, data storage, and other high-speed designs.

### Features:

- Interchangeable attenuator tips
- Signal integrity at high bandwidth
- Standard SMA cable connection
- Ultra low capacitance

## PP066 Specifications

### Electrical Characteristics

Bandwidth	DC to 7.5 GHz
Risetime	< 47 ps
Input Capacitance	< 0.20 pF
Input Resistance	500 $\Omega$ ( $\div 10$ cartridge) 1000 $\Omega$ ( $\div 20$ cartridge)
Maximum Voltage	15 V rms
Cable Length	1 m

## Ordering Information

### Product Description

7.5 GHz Low Capacitance Passive Probe  
( $\div 10$ , 1 k $\Omega$ ;  $\div 20$ , 500  $\Omega$ )

### Product Code

PP066

### Included with PP0066

PACC-AD001, SMA to BNC Adapter





**1-800-5-LeCroy**  
**teledynelecroy.com**

**Local sales offices are located throughout the world.**  
**Visit our website to find the most convenient location.**