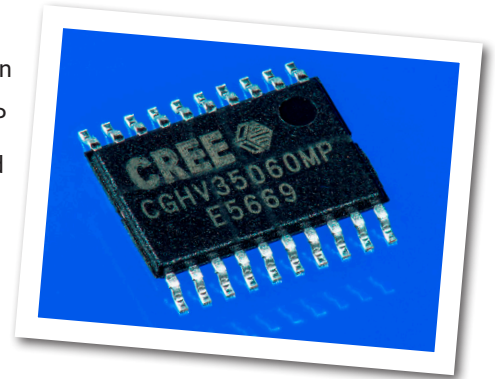


# CGHV35060MP

60W, 2700-3800 MHz, 50V, GaN HEMT for S Band Radar and LTE base stations

Cree's CGHV35060MP is a 60W input matched, gallium nitride (GaN) high electron mobility transistor (HEMT) optimized for S Band performance. The CGHV35060MP is suitable for typical bands of 2.7-3.1GHz and 3.1-3.5GHz while the input matched transistor provides optimal gain, power and efficiency in a small 6.5mm x 4.4mm plastic surface mount (SMT) package. The typical performance plots in the datasheet are derived with CGHV35060MP matched into a 3.1-3.5 GHz high power amplifier.



PN: CGHV35060MP

## Typical Performance Over 3.1 - 3.5 GHz ( $T_c = 25^\circ\text{C}$ ) of Demonstration Amplifier

Parameter	3.1 GHz	3.3 GHz	3.5 GHz	Units
Gain	14.5	14.3	13.8	dB
Output Power	88	88	75	W
Drain Efficiency	61	67	64	%

**Note:**

Measured in the CGHV35060MP-TB1 amplifier circuit, under 100  $\mu\text{s}$  pulse width, 10% duty cycle,  $P_{IN} = 35\text{ dBm}$ .

## Features

- Reference design amplifier 3.1 - 3.5 GHz
- 75W Typical output power
- 14.5 dB power gain
- 67% Drain efficiency
- Internally pre-matched on input, unmatched output



## Absolute Maximum Ratings (not simultaneous) at 25°C Case Temperature

Parameter	Symbol	Rating	Units	Conditions
Drain-Source Voltage	$V_{DSS}$	125	Volts	25°C
Gate-to-Source Voltage	$V_{GS}$	-10, +2	Volts	25°C
Storage Temperature	$T_{STG}$	-65, +150	°C	
Operating Junction Temperature	$T_J$	225	°C	
Maximum Forward Gate Current	$I_{GMAX}$	10.4	mA	25°C
Maximum Drain Current <sup>1</sup>	$I_{DMAX}$	6.3	A	25°C
Soldering Temperature <sup>2</sup>	$T_S$	245	°C	
CW Thermal Resistance, Junction to Case <sup>3</sup>	$R_{\theta JC}$	2.6	°C/W	85°C, $P_{DISS} = 52$ W
Pulsed Thermal Resistance, Junction to Case	$R_{\theta JC}$	1.95	°C/W	85°C, $P_{DISS} = 62$ W, 100 $\mu$ sec 10%
Case Operating Temperature <sup>4</sup>	$T_C$	-40, +107	°C	CW

Note:

<sup>1</sup> Current limit for long term, reliable operation.

<sup>2</sup> Refer to the Application Note on soldering at <http://www.cree.com/rf/document-library>

<sup>3</sup> Measured for the CGHV35060MP

<sup>4</sup> See also, the Power Dissipation De-rating Curve on Page 4.

## Electrical Characteristics ( $T_C = 25^\circ\text{C}$ )

Characteristics	Symbol	Min.	Typ.	Max.	Units	Conditions
<b>DC Characteristics<sup>1</sup></b>						
Gate Threshold Voltage	$V_{GS(th)}$	-3.8	-3.0	-2.3	$V_{DC}$	$V_{DS} = 10$ V, $I_D = 10.4$ mA
Gate Quiescent Voltage	$V_{GS(Q)}$	-	-2.7	-	$V_{DC}$	$V_{DS} = 50$ V, $I_D = 125$ mA
Saturated Drain Current <sup>2</sup>	$I_{DS}$	8.4	10.4	-	A	$V_{DS} = 6.0$ V, $V_{GS} = 2.0$ V
Drain-Source Breakdown Voltage	$V_{BR}$	150	-	-	$V_{DC}$	$V_{GS} = -8$ V, $I_D = 10.4$ mA
<b>RF Characteristics<sup>4</sup> (<math>T_C = 25^\circ\text{C}</math>, <math>F_0 = 3.225</math> GHz unless otherwise noted)</b>						
Saturated Output Power <sup>3,7</sup>	$P_{SAT}$	-	75	-	W	$V_{DD} = 50$ V, $I_{DQ} = 125$ mA, $P_{IN} = 34.5$ dBm
Pulsed Drain Efficiency <sup>3,7</sup>	$\eta$	-	59.1	-	%	$V_{DD} = 50$ V, $I_{DQ} = 125$ mA, $P_{IN} = 34.5$ dBm
Gain <sup>3,7</sup>	G	-	14.3	-	dB	$V_{DD} = 50$ V, $I_{DQ} = 125$ mA, $P_{IN} = 34.5$ dBm
Gain <sup>5,7</sup>	G	-	16.3	-	dB	$V_{DD} = 50$ V, $I_{DQ} = 125$ mA, $P_{OUT} = 41.5$ dBm
WCDMA Linearity <sup>5</sup>	ACLR	-	-35	-	dBc	$V_{DD} = 50$ V, $I_{DQ} = 125$ mA, $P_{OUT} = 41.5$ dBm
Drain Efficiency <sup>5</sup>	$\eta$	-	35	-	%	$V_{DD} = 50$ V, $I_{DQ} = 125$ mA, $P_{OUT} = 41.5$ dBm
Output Mismatch Stress <sup>3</sup>	VSWR	-	-	10:1	$\Psi$	No damage at all phase angles, $V_{DD} = 50$ V, $I_{DQ} = 125$ mA, $P_{OUT} = 60$ W Pulsed
<b>Dynamic Characteristics</b>						
Input Capacitance <sup>6</sup>	$C_{GS}$	-	32.16	-	pF	$V_{DS} = 50$ V, $V_{GS} = -8$ V, $f = 1$ MHz
Output Capacitance <sup>6</sup>	$C_{DS}$	-	4.4	-	pF	$V_{DS} = 50$ V, $V_{GS} = -8$ V, $f = 1$ MHz
Feedback Capacitance	$C_{GD}$	-	0.5	-	pF	$V_{DS} = 50$ V, $V_{GS} = -8$ V, $f = 1$ MHz

Notes:

<sup>1</sup> Measured on wafer prior to packaging.

<sup>2</sup> Scaled from PCM data.

<sup>3</sup> Pulse Width = 100  $\mu$ s, Duty Cycle = 10%

<sup>4</sup> Measured in CGHV35060MP-TB high volume test fixture.

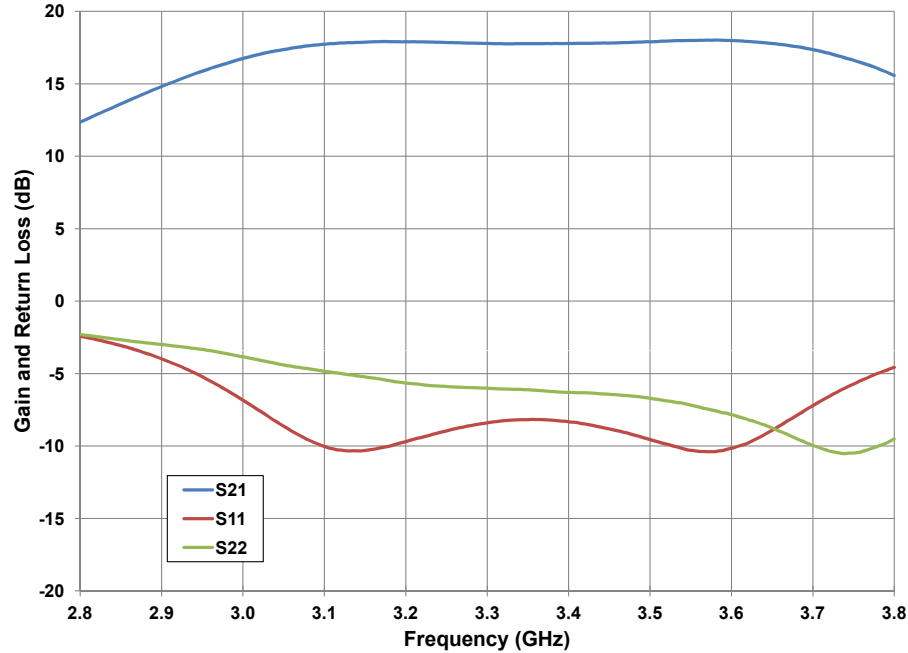
<sup>5</sup> Single Carrier WCDMA, 3GPP Test Model 1, 64 DPCH, 45% Clipping, PAR = 7.5 dB @ 0.01% Probability on CCDF,  $V_{DD} = 50$  V.

<sup>6</sup> Includes package.

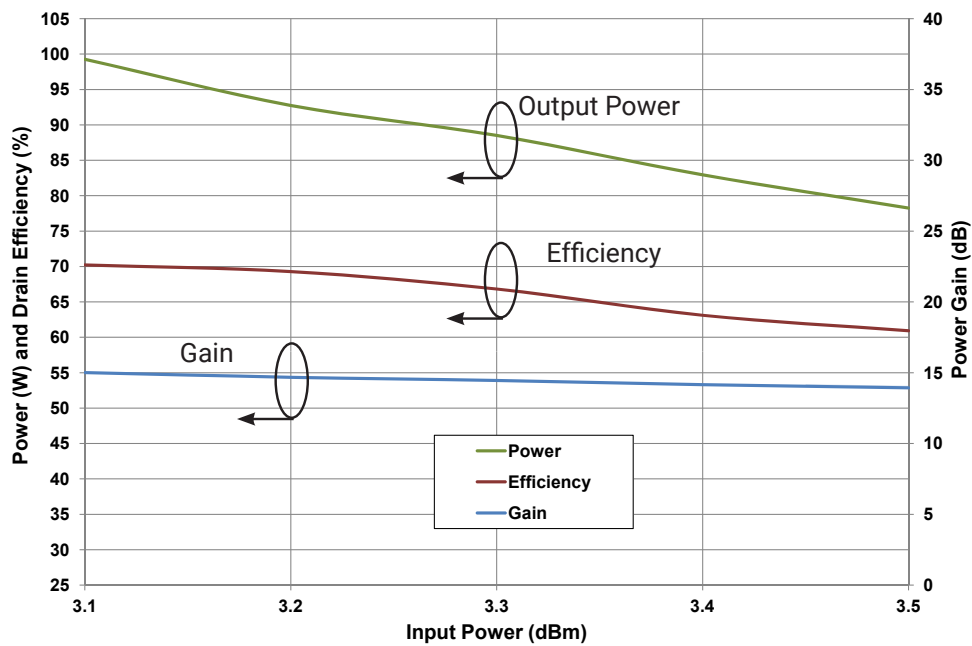
<sup>7</sup> Includes offsets correlating data taken in high volume test fixture to data taken in application circuit with device soldered down.

## Typical Performance

**Figure 1. - Small Signal Gain and Return Losses of the CGHV35060MP Measured in Demonstration Amplifier Circuit CGHV35060MP-TB1**

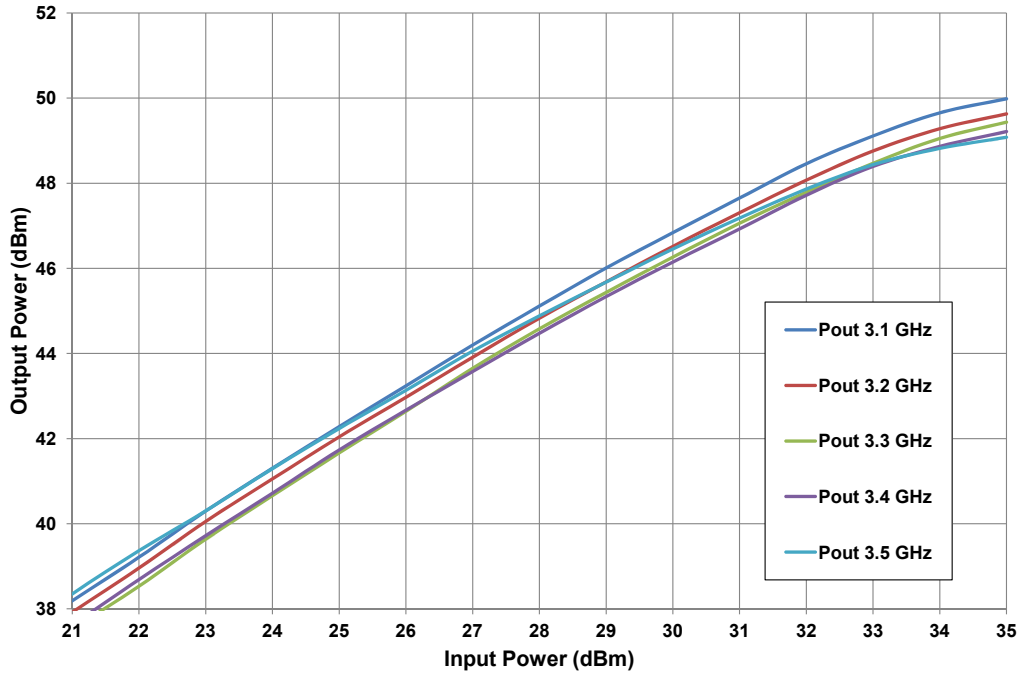


**Figure 2. - CGHV35060MP-TB1 Gain, Efficiency & Output Power**  
 $V_{DD} = 50\text{ V}$   $I_{DQ} = 125\text{ mA}$ , Pulse Width = 100 us, Duty Cycle = 10%,  $T_{case} = 25^\circ\text{C}$



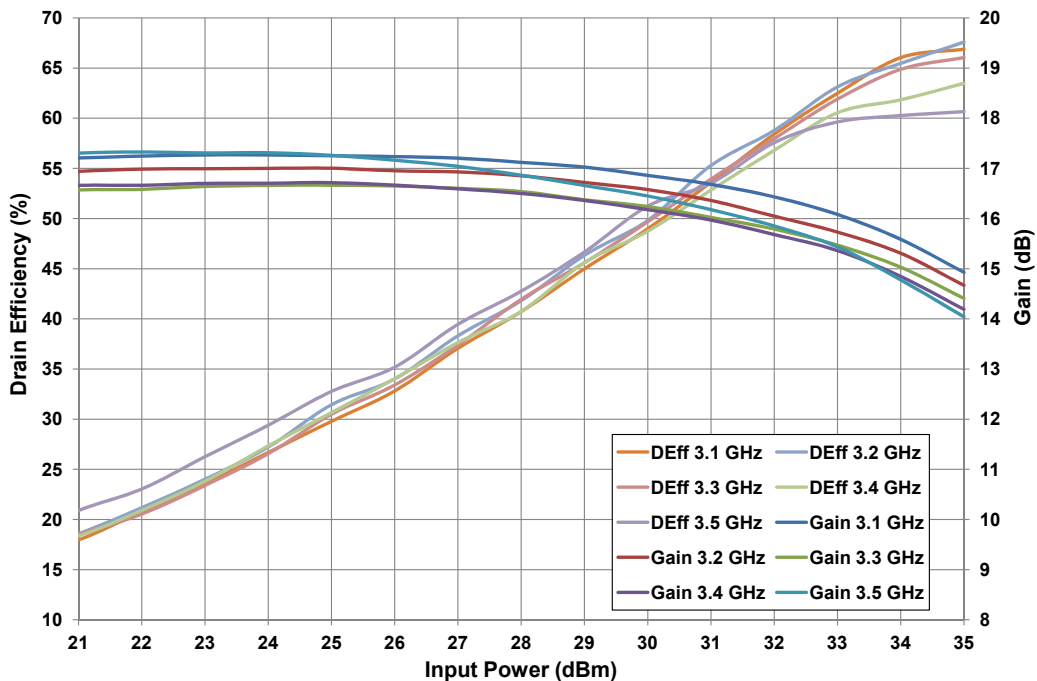
## Typical Performance

**Figure 3. - CGHV35060MP-TB1 Output Power vs. Input Power**  
 $V_{DD} = 50\text{ V}$   $I_{DQ} = 125\text{ mA}$ , Pulse Width = 100 us, Duty Cycle = 10%,  $T_{case} = 25^\circ\text{C}$



**Figure 4. - CGHV35060MP-TB1 Gain & Efficiency vs Input Power**

$V_{DD} = 50\text{ V}$   $I_{DQ} = 125\text{ mA}$ , Pulse Width = 100 us, Duty Cycle = 10%,  $T_{case} = 25^\circ\text{C}$



## Typical Performance

Figure 5. - CGHV35060MP-TB1 T<sub>j\_rise</sub> vs. Input Power

V<sub>DD</sub> = 50 V I<sub>DQ</sub> = 125 mA, Pulse Width = 100 us, Duty Cycle = 10%, T<sub>case</sub> = 25°C

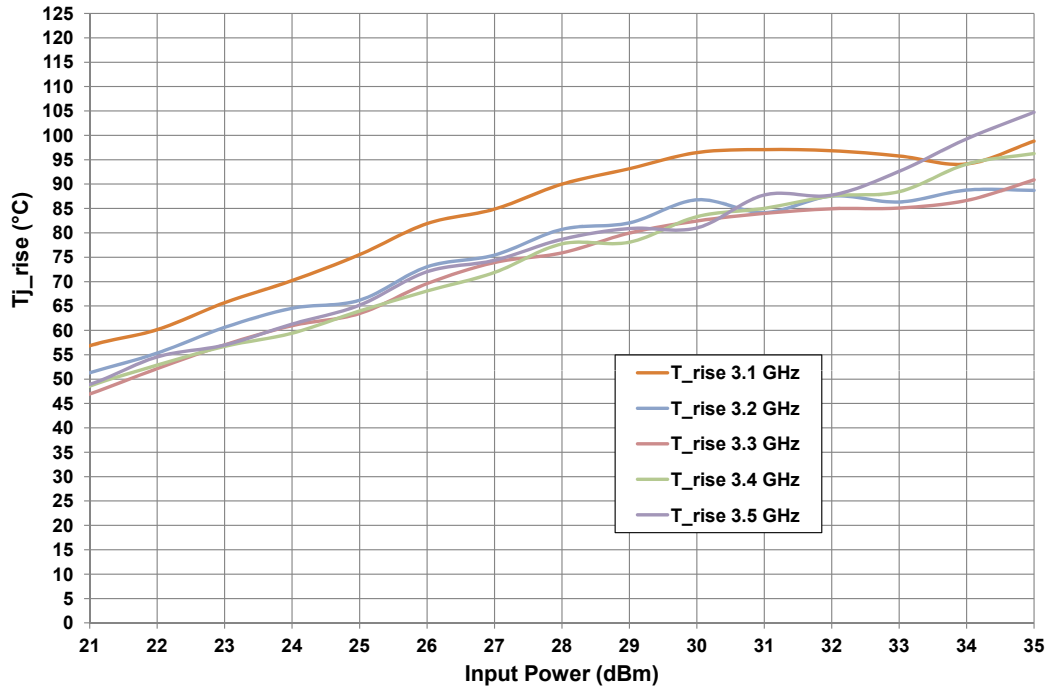
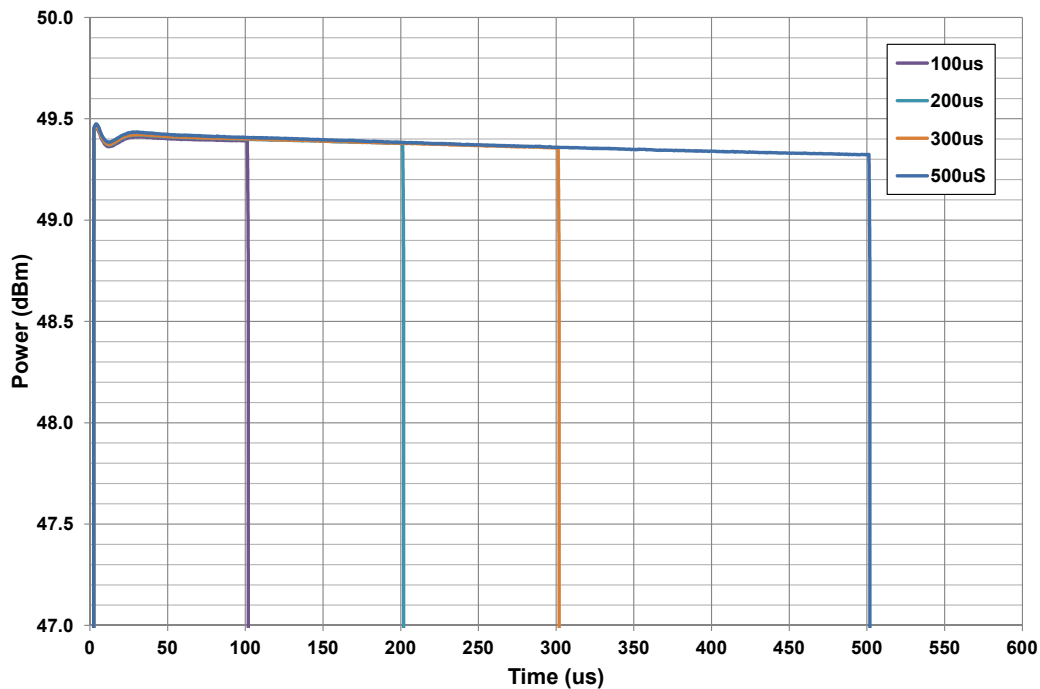
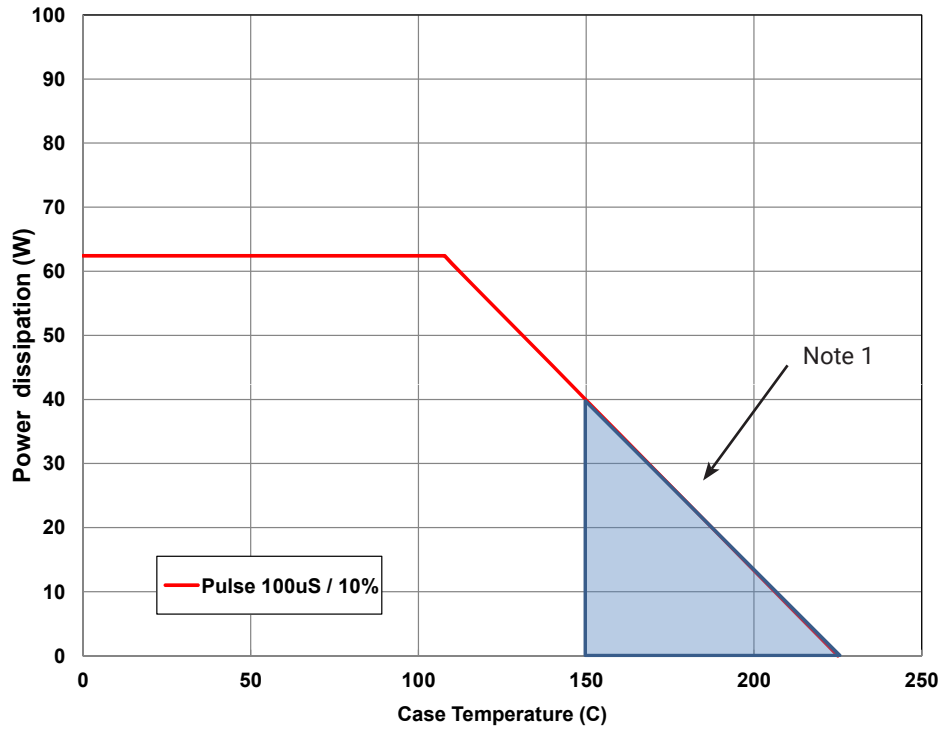


Figure 6. - CGHV35060MP-TB1 Output Power vs. Time, Varying Pulse Lengths

V<sub>DD</sub> = 50 V P<sub>IN</sub> = 35 dBm, Duty Cycle = 10%

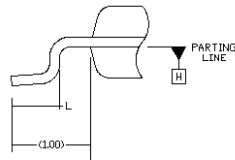
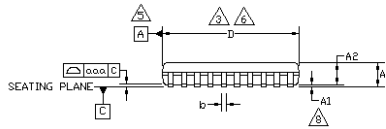
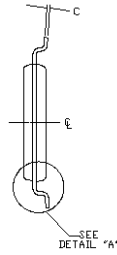
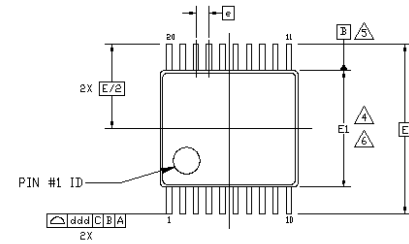


## CGHV35060MP Power Dissipation De-rating Curve

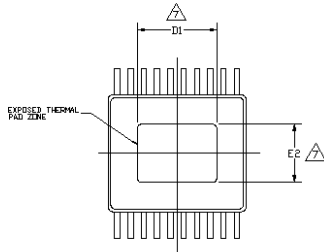


Note 1. Area exceeds Maximum Case Temperature (See Page 2).

## Product Dimensions CGHV35060MP (4.4 mm TSSOP 20-Lead Package)



DETAIL 'A'  
(VIEW ROTATED 90° C.W.)



### NOTES:

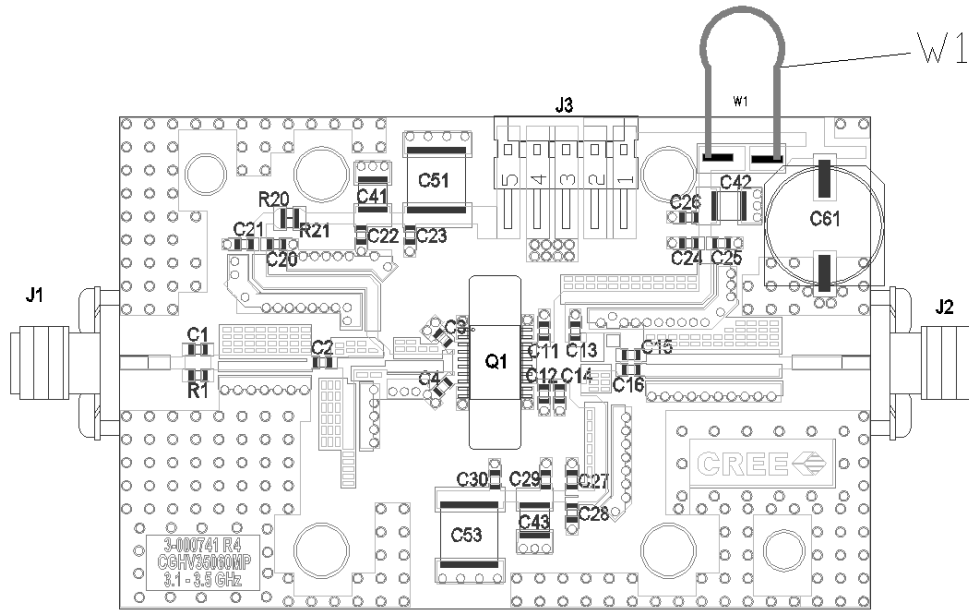
1. ALL DIMENSIONS ARE IN MILLIMETERS (ANGLES IN DEGREES).
2. DIMENSIONING & TOLERANCES PER ASME, Y14.5M-1994.
3. DIMENSION 'D' DOES NOT INCLUDE MOLD FLASH, PROTRUSIONS OR GATE BURRS. MOLD FLASH, PROTRUSIONS OR GATE BURRS SHALL NOT EXCEED 0.15 PER SIDE.
4. DIMENSION 'E1' DOES NOT INCLUDE INTERLEAD FLASH OR PROTRUSION. INTERLEAD FLASH OR PROTRUSION SHALL NOT EXCEED 0.25 PER SIDE.
5. DATUMS A AND B TO BE DETERMINED AT DATUM PLANE H.
6. DIMENSIONS 'D' AND 'E1' TO BE DETERMINED AT DATUM PLANE H.
7. 'D1' AND 'E2' DIMENSIONS DO NOT INCLUDE MOLD FLASH.
8. A1 IS DEFINED AS THE VERTICAL CLEARANCE FROM THE SEATING PLANE TO THE LOWEST POINT ON THE PACKAGE BODY.

### PINOUT TABLE

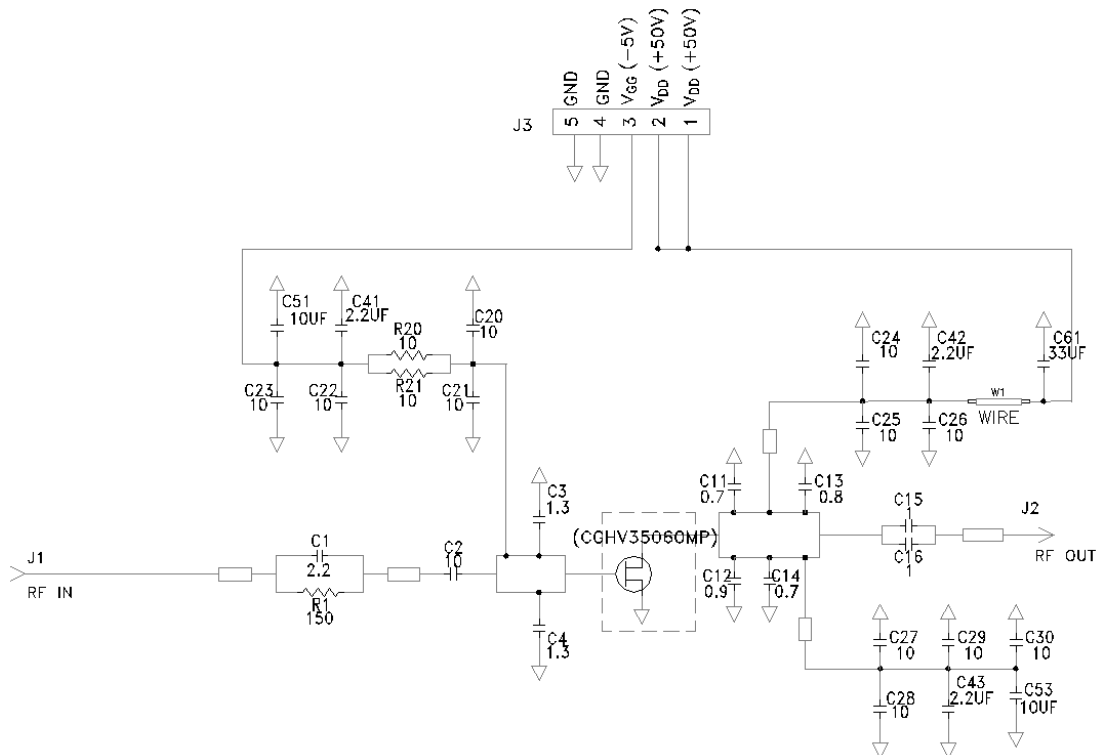
Symbol	COMMON DIMENSIONS			N <sub>D</sub> T <sub>E</sub>
	MIN.	NOM.	MAX.	
A			1.10	
A <sub>1</sub>	0.05		0.15	8
A <sub>2</sub>	0.85	0.90	0.95	
aaa	0.076			
b	0.19	-	0.30	
c	0.09	-	0.20	
D	6.40	6.50	6.60	3,6
E1	4.30	4.40	4.50	4,6
e	0.65 BSC			
E	6.40 BSC			
L	0.50	0.60	0.70	
D1	4.10	4.20	4.30	7
E2	2.90	3.00	3.10	7
ddd	0.20			

PIN	FUNCTION
1	GND
2	GND
3	RF INPUT
4	RF INPUT
5	RF INPUT
6	RF INPUT
7	RF INPUT
8	RF INPUT
9	GND
10	GND
11	GND
12	GND
13	RF OUTPUT
14	RF OUTPUT
15	RF OUTPUT
16	RF OUTPUT
17	RF OUTPUT
18	RF OUTPUT
19	GND
20	GND

## CGHV35060MP-AMP1 Application Circuit Outline

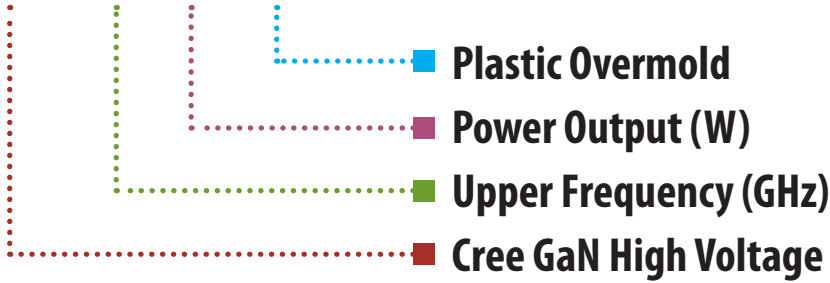


## CGHV35060MP-AMP1 Application Circuit Schematic





### CGHV35060MP



Parameter	Value	Units
Upper Frequency <sup>1</sup>	3.5	GHz
Power Output	60	W
Package	MP	-

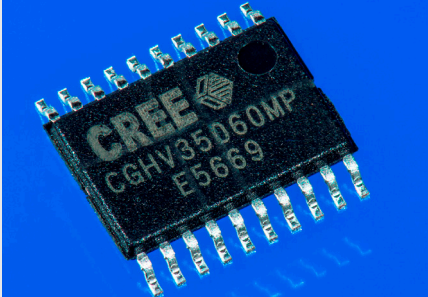
**Table 1.**

**Note<sup>1</sup>:** Alpha characters used in frequency code indicate a value greater than 9.9 GHz. See Table 2 for value.

Character Code	Code Value
A	0
B	1
C	2
D	3
E	4
F	5
G	6
H	7
J	8
K	9
Examples:	1A = 10.0 GHz 2H = 27.0 GHz

**Table 2.**

## Product Ordering Information

Order Number	Description	Unit of Measure	Image
CGHV35060MP	GaN HEMT	Each	
CGHV35060MP-AMP1	Test board with GaN HEMT installed	Each	
CGHV35060MP	GaN HEMT	Tape and Reel	



## Disclaimer

Specifications are subject to change without notice. Cree, Inc. believes the information contained within this data sheet to be accurate and reliable. However, no responsibility is assumed by Cree for any infringement of patents or other rights of third parties which may result from its use. No license is granted by implication or otherwise under any patent or patent rights of Cree. Cree makes no warranty, representation or guarantee regarding the suitability of its products for any particular purpose. "Typical" parameters are the average values expected by Cree in large quantities and are provided for information purposes only. These values can and do vary in different applications and actual performance can vary over time. All operating parameters should be validated by customer's technical experts for each application. Cree products are not designed, intended or authorized for use as components in applications intended for surgical implant into the body or to support or sustain life, in applications in which the failure of the Cree product could result in personal injury or death or in applications for planning, construction, maintenance or direct operation of a nuclear facility.

For more information, please contact:

Cree, Inc.  
4600 Silicon Drive  
Durham, North Carolina, USA 27703  
[www.cree.com/rf](http://www.cree.com/rf)

Sarah Miller  
Marketing  
Cree, RF Components  
1.919.407.5302

Ryan Baker  
Marketing & Sales  
Cree, RF Components  
1.919.407.7816

Tom Dekker  
Sales Director  
Cree, RF Components  
1.919.407.5639