

**S1D13748 Mobile Graphics Engine**

**S5U13748P00C100**  
**Evaluation Board User**  
**Manual**

## NOTICE

---

No part of this material may be reproduced or duplicated in any form or by any means without the written permission of Seiko Epson. Seiko Epson reserves the right to make changes to this material without notice. Seiko Epson does not assume any liability of any kind arising out of any inaccuracies contained in this material or due to its application or use in any product or circuit and, further, there is no representation that this material is applicable to products requiring high level reliability, such as, medical products. Moreover, no license to any intellectual property rights is granted by implication or otherwise, and there is no representation or warranty that anything made in accordance with this material will be free from any patent or copyright infringement of a third party. This material or portions thereof may contain technology or the subject relating to strategic products under the control of the Foreign Exchange and Foreign Trade Law of Japan and may require an export license from the Ministry of International Trade and Industry or other approval from another government agency.

All other product names mentioned herein are trademarks and/or registered trademarks of their respective companies.

©SEIKO EPSON CORPORATION 2007-2008, All rights reserved.

---

# Table of Contents

<b>Chapter 1 Introduction</b>	<b>5</b>
<b>Chapter 2 Features</b>	<b>6</b>
<b>Chapter 3 Installation and Configuration</b>	<b>7</b>
3.1 Configuration DIP Switch	7
3.2 Configuration Jumpers	8
<b>Chapter 4 Technical Description</b>	<b>12</b>
4.1 Power	12
4.1.1 Power Requirements	12
4.1.2 Voltage Regulators	12
4.1.3 S1D13748 Power	12
4.2 Clocks	13
4.3 Reset	13
4.4 Host Interface	14
4.4.1 Direct Host Bus Interface Support	14
4.4.2 Connecting to the Epson S5U13U00P00C100 USB Adapter Board	15
4.5 LCD Panel Interface	16
4.6 GPIO Connections	17
<b>Chapter 5 Parts List</b>	<b>18</b>
<b>Chapter 6 Schematic Diagrams</b>	<b>20</b>
<b>Chapter 7 Board Layout</b>	<b>23</b>
<b>Chapter 8 References</b>	<b>25</b>
8.1 Documents	25
8.2 Document Sources	25



# Chapter 1 Introduction

This manual describes the setup and operation of the S5U13748P00C100 Evaluation Board. The evaluation board is designed as an evaluation platform for the S1D13748 Mobile Graphics Engine.

The S5U13748P00C100 evaluation board can be used with many native platforms via the host connector which provides the appropriate signals to support a variety of CPUs. The S5U13748P00C100 evaluation board can also connect to the S5U13U00P00C100 USB Adapter board so that it can be used with a laptop or desktop computer, via USB 2.0.

This user manual is updated as appropriate. Please check the Epson Research and Development Website at [www.erd.epson.com](http://www.erd.epson.com) for the latest revision of this document before beginning any development.

We appreciate your comments on our documentation. Please contact us via email at [documentation@erd.epson.com](mailto:documentation@erd.epson.com).

## Chapter 2 Features

The S5U13748P00C100 Evaluation Board includes the following features:

- 144-pin QFP20 S1D13748 Mobile Graphics Engine
- Header with all S1D13748 Host Bus Interface signals
- Headers for connection to the S5U13U00P00C100 USB Adapter board
- Headers for connecting to LCD panels
- Header for S1D13748 GPIO pins (optional)
- On-board 4MHz oscillator
- 14-pin DIP socket (if a clock other than 4MHz must be used)
- 3.3V input power
- On-board voltage regulator with 1.5V output
- On-board voltage regulator with adjustable 12~25V output, 60~100mA max., to provide power for LED back-light of LCD panels.

## Chapter 3 Installation and Configuration

The S5U13748P00C100 evaluation board incorporates a DIP switch, jumpers, and 0 ohm resistors which allow it to be used with a variety of different configurations.

### 3.1 Configuration DIP Switch

The S1D13748 has 2 configuration inputs (CNF[2:1]). A DIP switch (SW1) is used to configure CNF[2:1] as described below.

*Table 3-1: Configuration DIP Switch Settings*

SDU13748P00C100 SW1-[2:1] Config	S1D13748 CNF[2:1] Config	Power-On/Reset State	
		1 (ON)	0 (OFF)
SW1-[2]	CNF2	Big Endian	Little Endian
SW1-[1]	CNF1	Indirect 68	Indirect 80

**Yellow background cells** = Required settings when using S5U13U00P00C100 USB Adapter board

The following figure shows the location of DIP switch SW1 on the S5U13748P00C100 board.

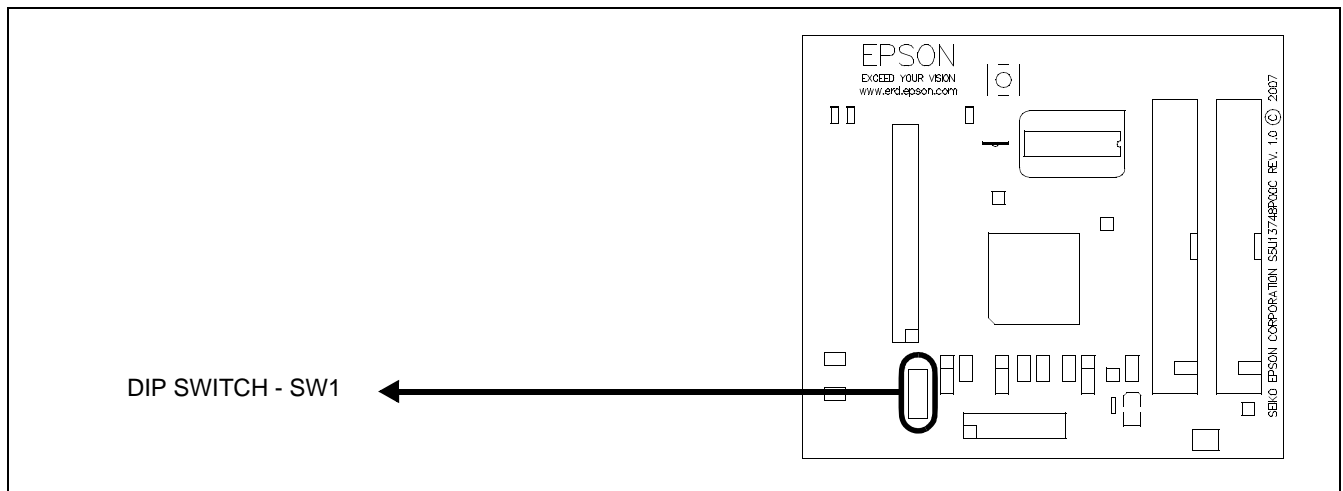

*Figure 3-1: Configuration DIP Switch (SW1) Location*

## 3.2 Configuration Jumpers

The S5U13748P00C100 has 8 jumpers which configure various board settings. The jumper positions for each function are shown below.

*Table 3-2: Configuration Jumper Settings*

Jumper	Function	Position 1-2	Position 2-3	No Jumper
JP1	COREVDD	Normal	—	COREVDD current measurement
JP2	PLLVD	Normal	—	PLLVD current measurement
JP3	HIOVDD	Normal	—	HIOVDD current measurement
JP4	HIOVDD Source	H1 connector, pin 32	3.3VDD	—
JP5	PIOVDD	Normal	—	PIOVDD current measurement
JP6	PIOVDD Source	H4 connector, pin 2	3.3VDD	—
JP7	GIOVDD	Normal	—	GIOVDD current measurement
JP8	GIOVDD Source	H4 connector, pin 6	3.3VDD	—

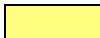
 = Required settings when using S5U13U00P00C100 USB Adapter board



## JP1, JP2, JP3, JP5, JP7 - Power Supplies for the S1D13748

JP1, JP2, JP3, JP5, and JP7 can be used to measure the current consumption of each S1D13748 power supply. When the jumper is at position 1-2, normal operation is selected.

When no jumper is installed, the current consumption for each power supply can be measured by connecting an ammeter to pin 1 and 2 of the jumper.

The jumper associated with each power supply is as follows:

JP1 for COREVDD

JP2 for PLLVDD

JP3 for HIOVDD

JP5 for PIOVDD

JP7 for GIOVDD

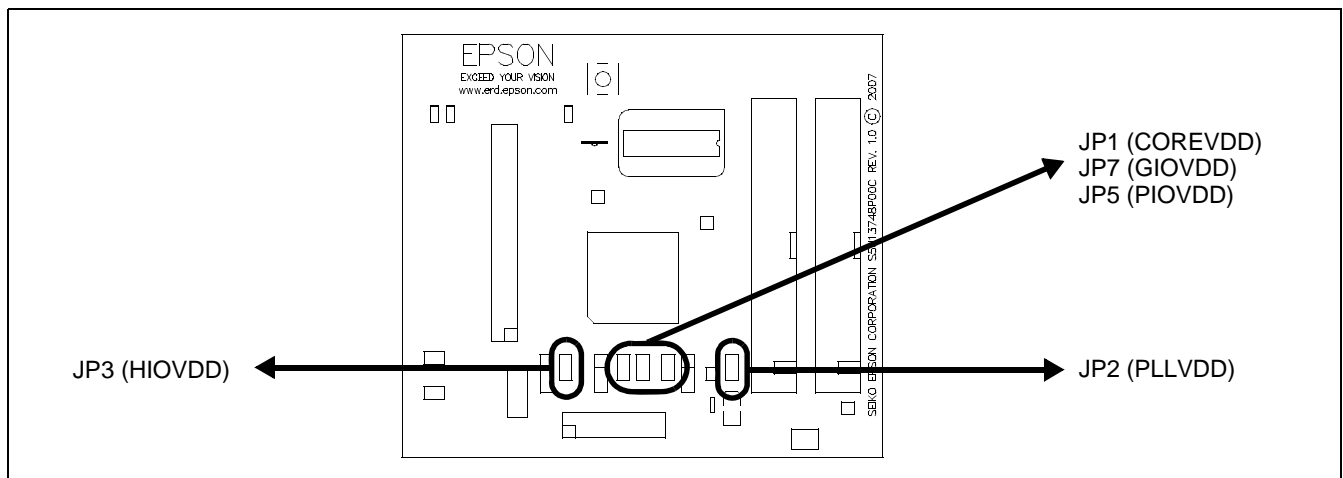

Figure 3-2: Configuration Jumper Locations (JP1, JP2, JP3, JP5, JP7)

## JP4 - HIOVDD Source

JP4 is used to select the source for the HIOVDD supply voltage.

When the jumper is at position 1-2, the HIOVDD voltage must be provided to pin 32 on the H1 connector.

When the jumper is at position 2-3, the HIOVDD voltage is provided by the 3.3V power supply of the board.

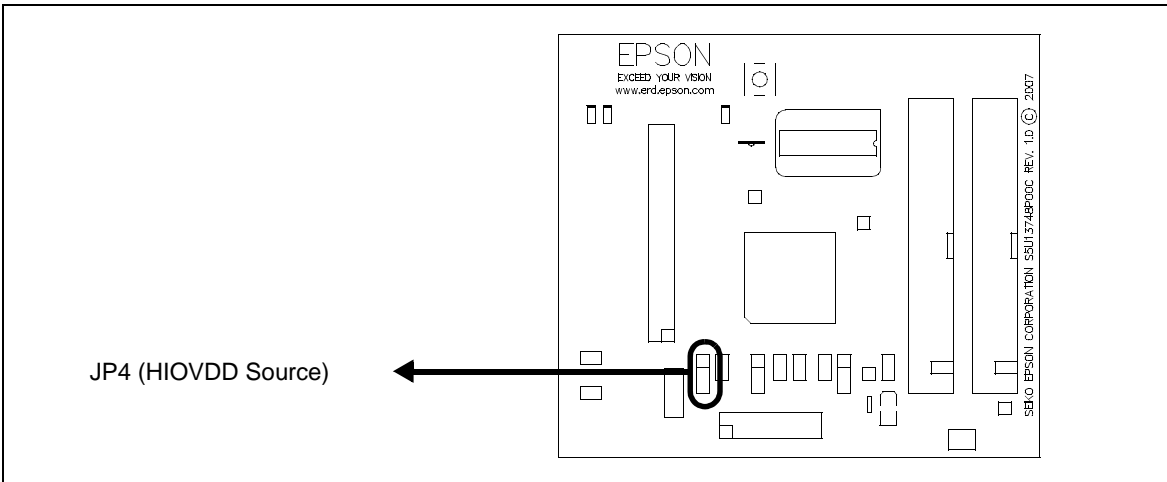

Figure 3-3: Configuration Jumper Location (JP4)

## JP6 - PIOVDD Source

JP6 is used to select the source for the PIOVDD supply voltage.

When the jumper is at position 1-2, the PIOVDD voltage must be provided to pin 2 on the H4 connector.

When the jumper is at position 2-3, the PIOVDD voltage is provided by the 3.3V power supply of the board.

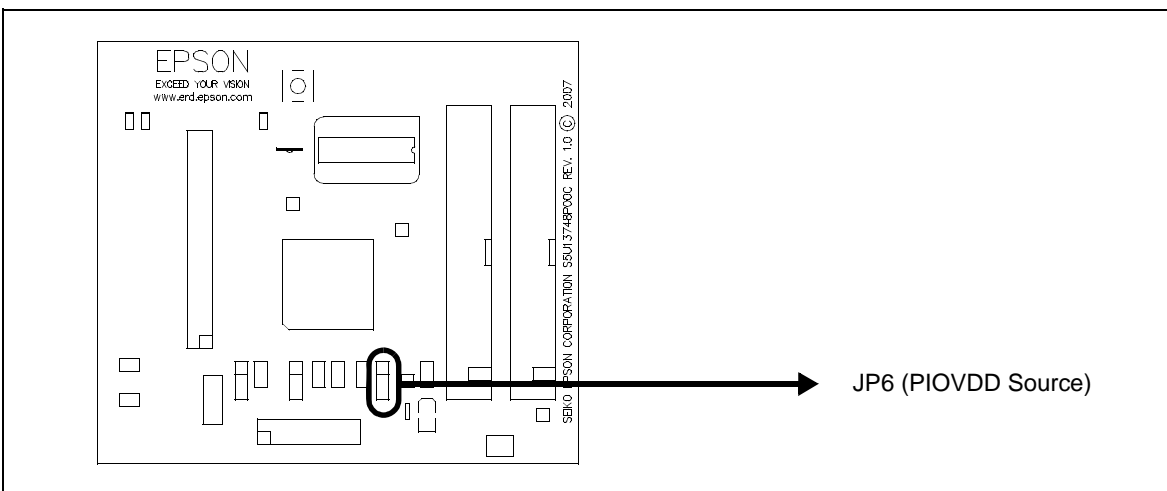

Figure 3-4: Configuration Jumper Location (JP6)

## JP8 - GIOVDD Source

JP8 is used to select the source for the GIOVDD supply voltage.

When the jumper is at position 1-2, the GIOVDD voltage must be provided to pin 6 on the H4 connector.

When the jumper is at position 2-3, the GIOVDD voltage is provided by the 3.3V power supply of the board.

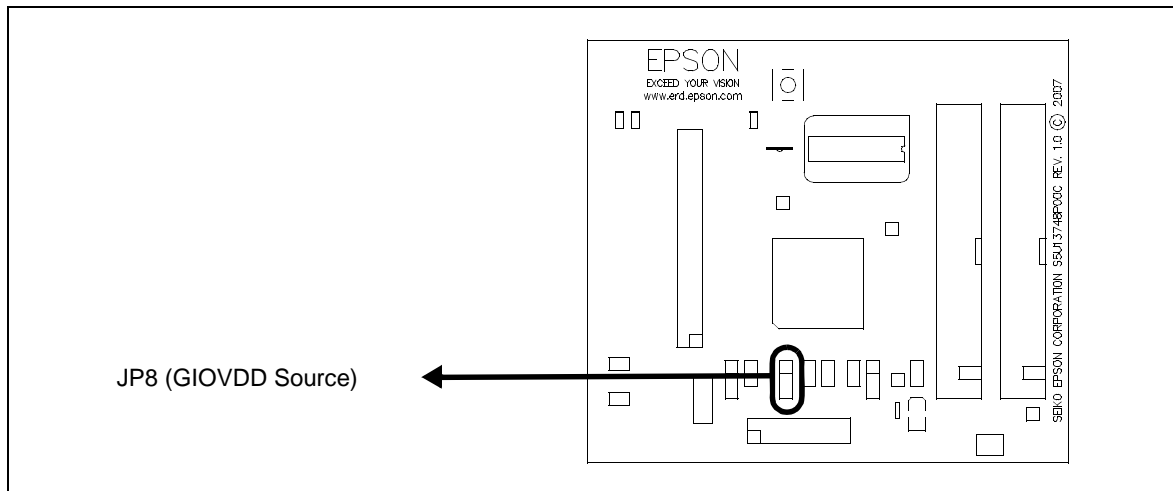

*Figure 3-5: Configuration Jumper Location (JP8)*

# Chapter 4 Technical Description

## 4.1 Power

### 4.1.1 Power Requirements

The S5U13748P00C100 evaluation board requires an external regulated power supply (3.3V / 1A). The power is supplied to the evaluation board through pin 34 of the H1 header, or pin 5 of the P2 header.

The green LED “3.3V Power” is turned on when 3.3V power is applied to the board.

### 4.1.2 Voltage Regulators

The S5U13748P00C100 evaluation board has an on-board linear regulator to provide the 1.5V power required by the S1D13748 Mobile Graphics Engine. It also has a step-up switching voltage regulator to generate adjustable 12~25V, which can be used to power the LED backlight on some LCD panels.

### 4.1.3 S1D13748 Power

The S1D13748 Mobile Graphics Engine requires 1.5V and 1.65~3.6V power supplies.

1.5V power for COREVDD and PLLVDD is provided by an on-board linear voltage regulator.

HIOVDD can range from 1.65V to 3.6V. When JP4 is set to the 2-3 position, HIOVDD is connected to 3.3V. If a different voltage is required for HIOVDD, set JP4 to the 1-2 position and connect the external power supply to pin 32 of connector H1.

#### **Note**

If the HIOVDD voltage is less than 3.0V, an oscillator working at the selected HIOVDD voltage must be used.

PIOVDD is the power used by the LCD interface and GPIO[23:8] and can range from 1.65V to 3.6V. When JP6 is set to the 2-3 position, PIOVDD is connected to 3.3V. If a different voltage is needed for PIOVDD because of the LCD panel requirements, set JP6 to the 1-2 position and connect the external power supply to pin 2 of connector H4.

GIOVDD is the power used by GPIO[7:0] and can range from 1.65V to 3.6V. When JP8 is set to the 2-3 position, GIOVDD is connected to 3.3V. If a different voltage is needed for GIOVDD, set JP8 to the 1-2 position and connect the external power supply to pin 6 of connector H4.

## 4.2 Clocks

The clock for the S1D13748 Mobile Graphics Engine is provided by a 4MHz oscillator.

The S5U13748P00C100 evaluation board has a DIP14 footprint for an optional second oscillator, Y2. This is provided for cases requiring a different clock frequency for the S1D13748 Mobile Graphics Engine. To use Y2, an oscillator must be populated in the Y2 footprint and the following board modifications must be made.

1. Remove R9 (33 ohm resistor, size 0402) to cut the output of Y1.
2. Populate R11 with a 33 ohm resistor, size 0402, to connect the output of Y2 to the CLKI input of the S1D13748 Mobile Graphics Engine.

### Note

If the board is configured for an HIOVDD voltage below 3.0V, an oscillator working at the selected HIOVDD voltage must be used at Y2. The on-board 4MHz oscillator is not specified to work below a 3.0V supply voltage.

## 4.3 Reset

The S1D13748 Mobile Graphics Engine on the S5U13748P00C100 evaluation board can be reset using a push-button switch (SW2), or via an active low reset signal from the host development platform (pin 33 on the H1 connector).

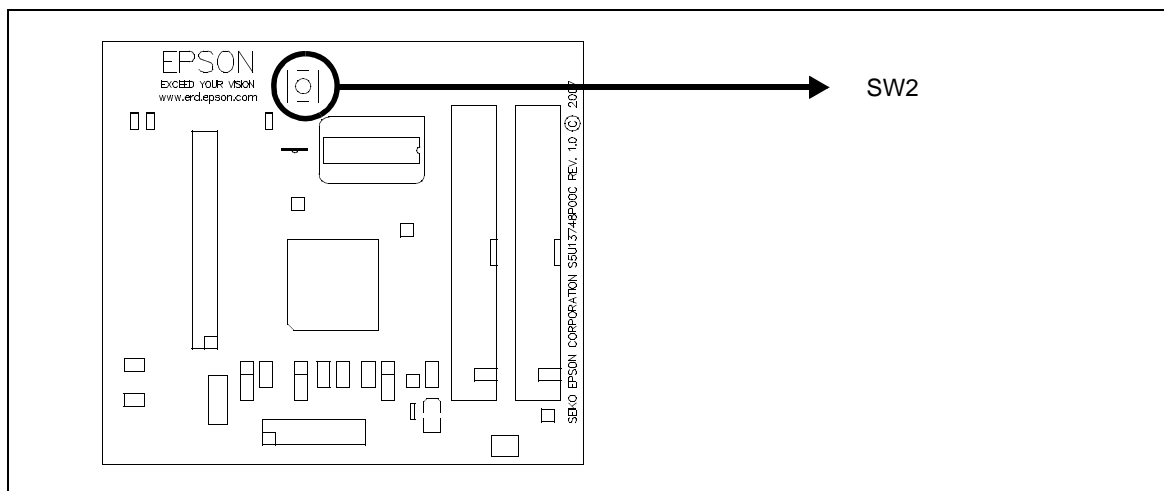

Figure 4-1: Reset Switch (SW2)

## 4.4 Host Interface

### 4.4.1 Direct Host Bus Interface Support

All S1D13748 host interface pins are available on connector H1 which allows the S5U13748P00C100 evaluation board to be connected to a variety of development platforms. For detailed S1D13748 pin mapping, refer to the *S1D13748 Hardware Functional Specification*, document number X80A-A-001-xx.

The following figure shows the location of host bus connector H1. H1 is a 0.1” x 0.1” 34-pin header (17 x 2).

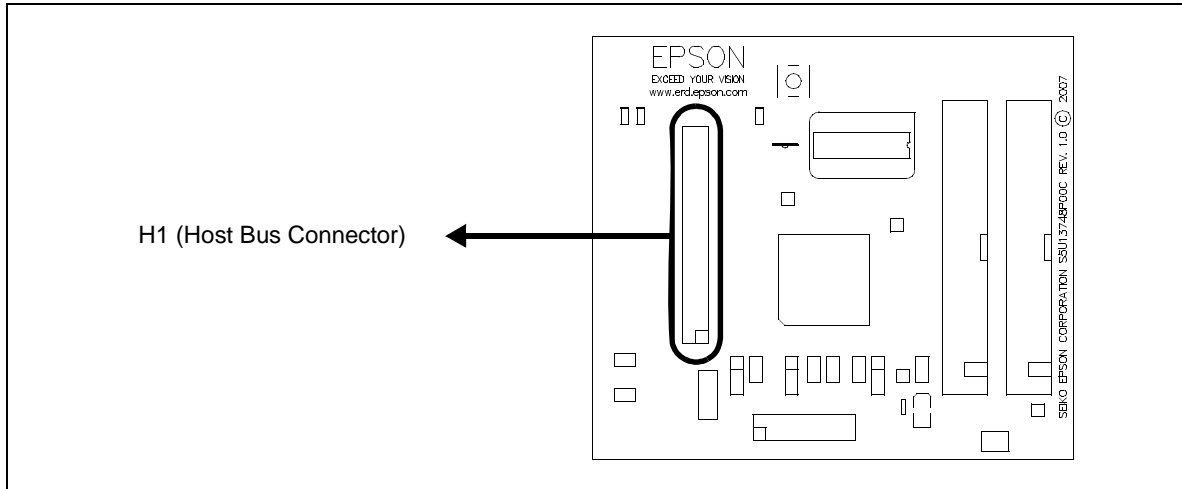

Figure 4-2: Host Bus Connector Location (H1)

For the pinout of connector H1, see Section Chapter 6, “Schematic Diagrams” on page 20.

#### 4.4.2 Connecting to the Epson S5U13U00P00C100 USB Adapter Board

The S5U13748P00C100 evaluation board is designed to connect to a S5U13U00P00C100 USB Adapter Board. The USB adapter board provides a simple connection to any computer via a USB 2.0 connection. The S5U13748P00C100 directly connects to the USB adapter board through connectors P1 and P2.

The USB adapter board also supplies the 3.3V power required by the S5U13748P00C100. HIOVDD should be selected for 3.3V and JP4 should be set to the 2-3 position.

When the S5U13748P00C100 is connected to the S5U13U00P00C100 USB Adapter board, there are 2 LEDs on the S5U13748P00C100 which provide a quick visual status of the USB adapter. LED1 blinks to indicate that the USB adapter board is active. LED2 turns on to indicate that the USB has been enumerated by the PC.

The following diagram shows the location of connectors P1 and P2. P1 and P2 are 2mm x 2mm, 40-pin headers (20 x 2).

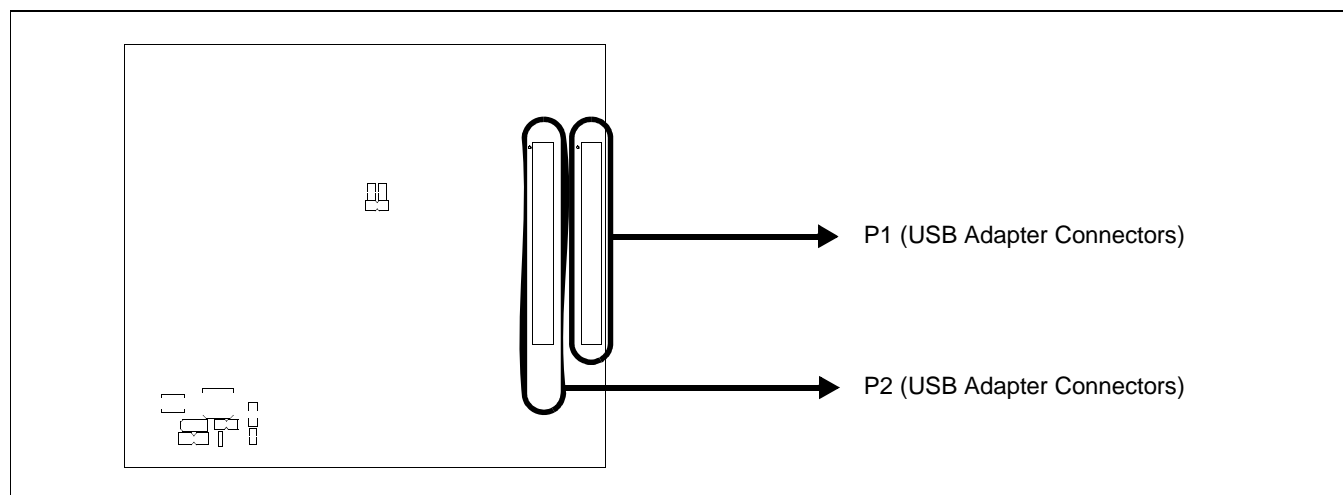

*Figure 4-3: USB Adapter Connector Locations (P1 and P2)*

For the pinout of connectors P1 and P2, see Section Chapter 6, “Schematic Diagrams” on page 20.

#### Note

A windows driver must be installed on the PC when the S5U13748P00C100 is used with the S5U13U00P00C100 USB Adapter Board. The S1D13xxxUSB driver is available at [www.erd.epson.com](http://www.erd.epson.com).

## 4.5 LCD Panel Interface

The LCD interface signals are available on connectors H2 and H3. Two signals used for LCD bypass are available on pin 1 and pin 3 of connector H4. Note that connector H4 is not populated on the S5U13748P00C100 evaluation board.

For S1D13748 LCD interface pin mapping, refer to the *S1D13748 Hardware Functional Specification*, document number X80A-A-001-xx.

On the evaluation board there is an adjustable 12~25V power supply. At 12V, the maximum current available is 100mA. At 25V, the maximum current available is 60mA. This power supply is intended for use to power the LED backlight on some LCD panels. The voltage is adjusted by the R20 pot.

### Note

For LCD panels that use a CCFL backlight, an external power supply must be used to provide power to the inverter for the CCFL backlight. Usually, the inverter current consumption is higher than the maximum 100mA current available from the on-board voltage regulator.

Connectors H2 and H3 are 0.1" x 0.1", 40-pin headers (20 x 2). Connector H4 is a 0.1" x 0.1", 16-pin header (16 x 2). The following diagram shows the location of connectors H2, H3, and H4.

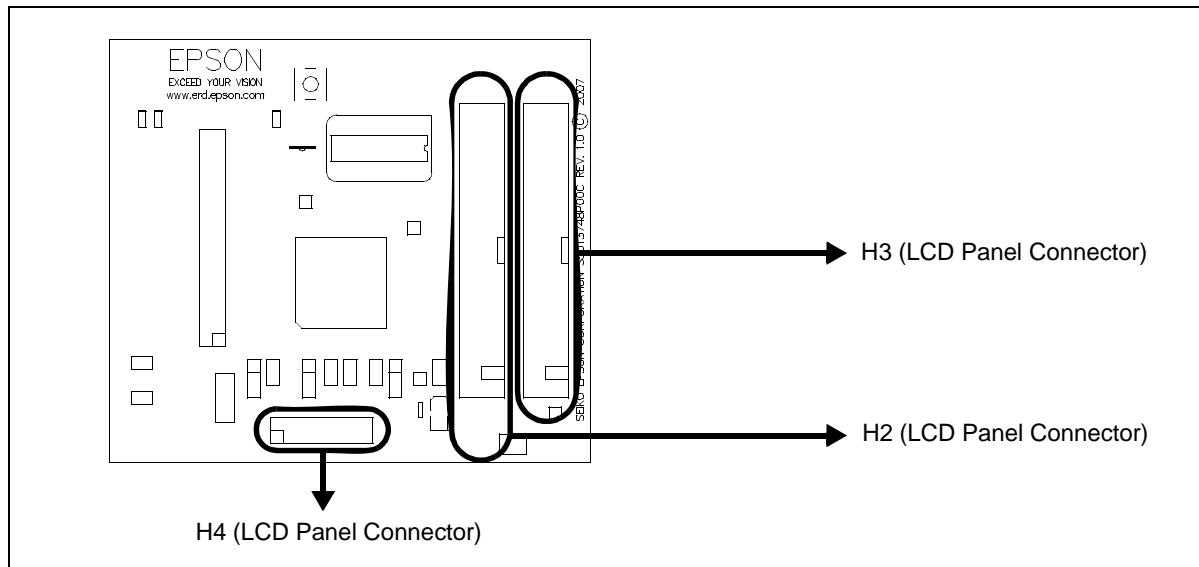

Figure 4-4: LCD Panel Connectors Location (H2, H3, H4)

For the pinout of connectors H2, H3 and H4, see Section Chapter 6, “Schematic Diagrams” on page 20.



## 4.6 GPIO Connections

The S1D13748 Mobile Graphics Engine has 24 GPIO pins. The GPIO[23:8] pins have dual functions and are selectable between a LCD output or GPIO function. They are powered from PIOVDD. For S1D13748 LCD interface pin mapping, refer to the *S1D13748 Hardware Functional Specification*, document number X80A-A-001-xx.

The GPIO[7:0] pins only function as GPIOs and are powered from GIOVDD. All the GPIO pins are available on the H3 and H4 connectors. Note that connector H4 is not populated on the S5U13748P00C100 evaluation board.

Connector H3 is a 0.1" x 0.1", 40-pin header and connector H4 is a 0.1" x 0.1", 16-pin header (8 x 2). The following figure shows the location of the connector H3 and H4.

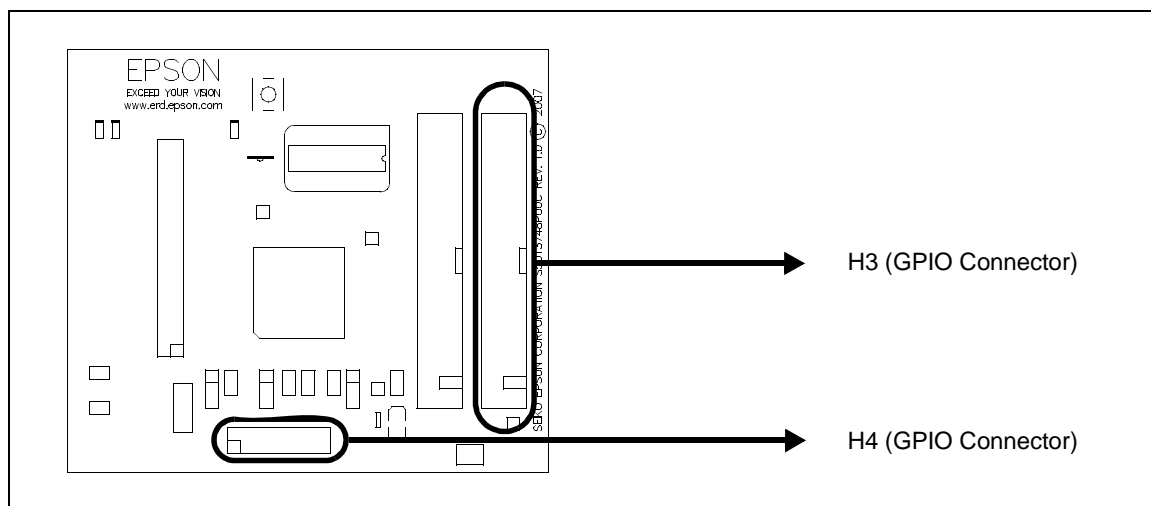

Figure 4-5: GPIO Connector Location (H3, H4)

For the pinout of connector H3 and H4, see Section Chapter 6, “Schematic Diagrams” on page 20.

# Chapter 5 Parts List

Table 5-1: S5U13748P00C100 Parts List

Item	Qty	Reference	Part	Description	Manufacturer Part No
1	38	C1, C2, C3, C4, C5, C6, C7, C8, C9, C10, C11, C12, C13, C27, C30, C31, C32, C33, C34, C35, C36, C37, C46, C47, C48, C49, C50, C51, C52, C53, C54, C55, C66, C67, C70, C71, C73, C75	0.1uF	C0402	Yageo America 04022F104Z7B20D
2	35	C14, C15, C16, C17, C18, C19, C20, C21, C22, C23, C24, C25, C26, C38, C39, C40, C41, C42, C43, C44, C45, C56, C57, C58, C59, C60, C61, C62, C63, C64, C65, C68, C69, C74, C76	0.01uF	C0402	Kemet C0402C103K4RACTU
3	1	C28	1nF	C0402	Yageo America 04022R102K9B20D
4	1	C29	10uF	C0805	Panasonic - ECG ECJ-CV50J106M
5	1	C72	4.7uF 10V T	CAPACITOR TANT 4.7UF 10V 10% SMD C3528	Kemet T494B475K010AT
6	1	C77	2.2uF 10V	CAP CER 2.2UF 10V X7R 0805 C0805	Taiyo Yuden LMK212BJ225KG-T
7	1	C78	150pF	C0402	Panasonic - ECG ECJ-0EC1H151J
8	1	C79	10uF 35V	CAP CER 10UF 35V X5R 1210 C1206	Taiyo Yuden GMK325BJ106KN-T
9	3	D1, D2, D3		LED GREEN SS TYPE LOW CUR SMD LED0603	Panasonic - SSG LNJ308G8LRA
10	1	D4	MBR0540	SOD-123	Micro Commercial Co. MBR0540-TP
11	1	F1	ACH32C-333-T	FILTER 3-TERM 10MHZ to 300MHz SMD	TDK ACH32C-333-T
12	1	F2	ACF451832-222	FILTER 3-TERM 60MHZ 300MA SMD	TDK ACF451832-222
13	1	H1	Host Connector		Samtec TSW-117-07-G-D
14	2	H2, H3			Samtec TST-120-01-G-D
15	0	H4	GPIO Connector		Samtec TSW-108-07-G-D
16	5	JP1, JP2, JP3, JP5, JP7		CONN HEADER VERT 2POS .100 TIN or GENERIC SIP2	
17	3	JP4, JP6, JP8		CONN HEADER VERT 3POS .100 TIN or GENERIC SIP3	
18	2	L1, L2	Ferrite	FERRITE 200MA 938 OHMS 0603 SMD R0603	Steward HZ0603B751R-10

Table 5-1: S5U13748P00C100 Parts List (Continued)

Item	Qty	Reference	Part	Description	Manufacturer Part No
19	1	L3	10uH	COIL 10UH 1300MA CHOKE SMD IND_ELL6	Panasonic - ECG ELL-6SH100M
20	2	P1, P2	HEADER_20X2	HDR2X20/2MM	3M 151240-8422-RB
21	3	R1, R2, R18	10k	R0402	
22	3	R3, R6, R15	0	R0603	
23	1	R4	150k 1%	R0402	
24	3	R5, R7, R8	0	R0402	
25	1	R9	33 1%	R0402	
26	0	R10, R11	NP	R0402	
27	3	R12, R13, R14	270 1%	R0402	
28	1	R16	56k	R0402	
29	1	R17	120k	R0402	
30	1	R19	13.3k 1%	R0402	
31	1	R20	200k	POT 200K OHM 3MM CARBON TRIM SMD	Panasonic - ECG EVN-5ESX50B25
32	8	SH1, SH2, SH3, SH4, SH5, SH6, SH7, SH8	.100 in. Jumper Shunt	JUMPER SHORTING TIN	Sullins Electronics Corp. STC02SYAN
33	1	SW1	SW2_DIPSW2	SWITCH DIP HALF PITCH 2POS DIPSW2	CTS Corp 218-2LPST
34	1	SW2	SW TACT-SPST	SWITCH TACT SILVER PLT GULLWING SW_EVQQW	ITT Industries KSC241GLFS
35	2	TPGND1, TP3.3VDD1	TP_SMT	PC TEST POINT MINIATURE SMT TP_1206	Keystone 5015
36	1	U1	S1D13748QFP144		
37	1	U2	TPS76915DBVT	IC 1.5V 100MA LDO REG SOT-23-5	Texas Instruments TPS76915DBVT
38	1	U3	LM2733Y	IC CONV BOOST 40V FET SW SOT23-5	National Semiconductor LM2733YMF/NOPB
39	1	Y1	4M OSC	OSC 4.0000MHz 3.3V 50ppm SMD	Connor-Winfield CWX823-4.0M
40	0	Y2	14-Pin DIP		AMP 2-641609-1

# Chapter 6 Schematic Diagrams

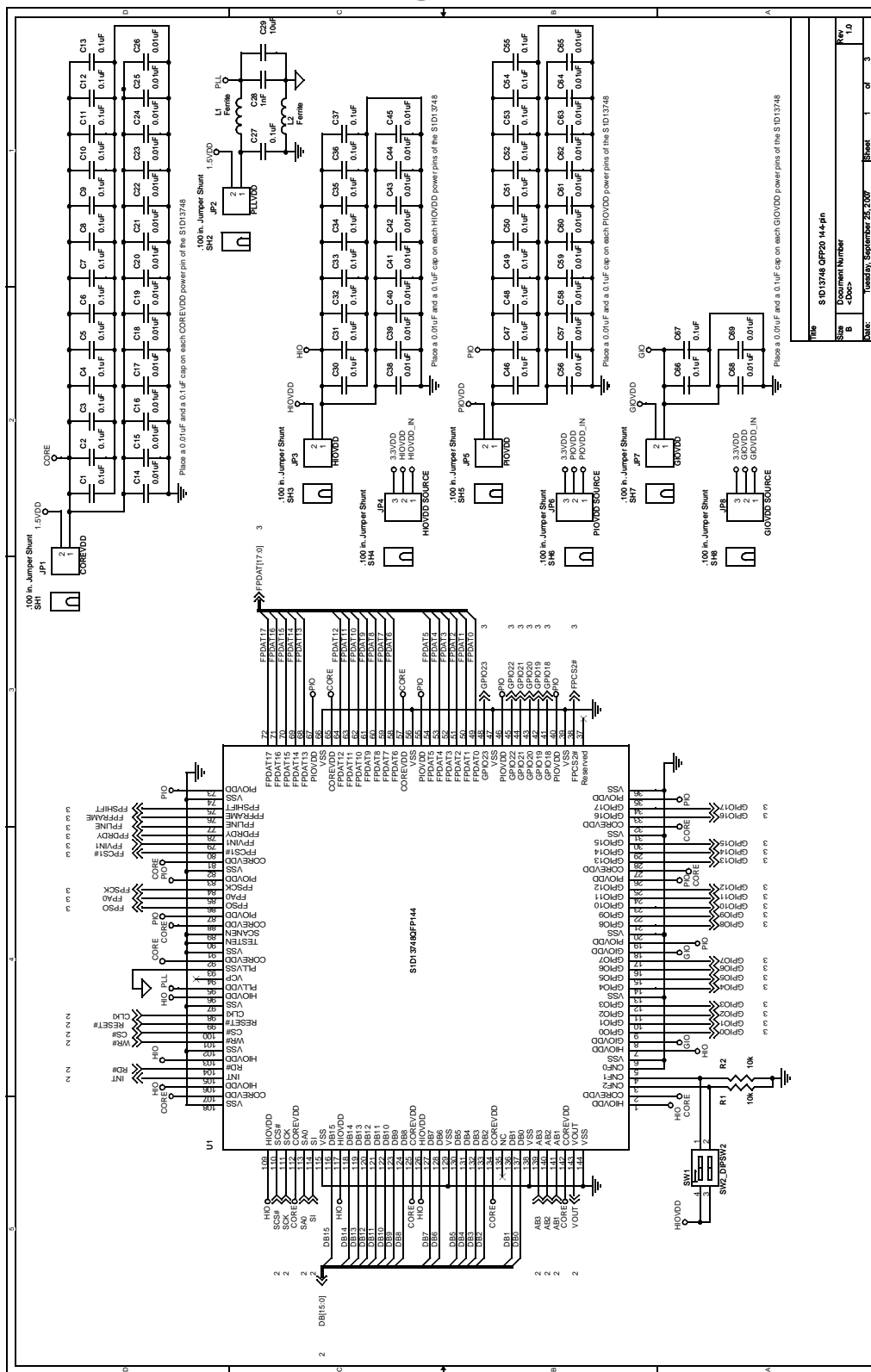

Figure 6-1: S5U13748P00C100 Schematics (1 of 3)

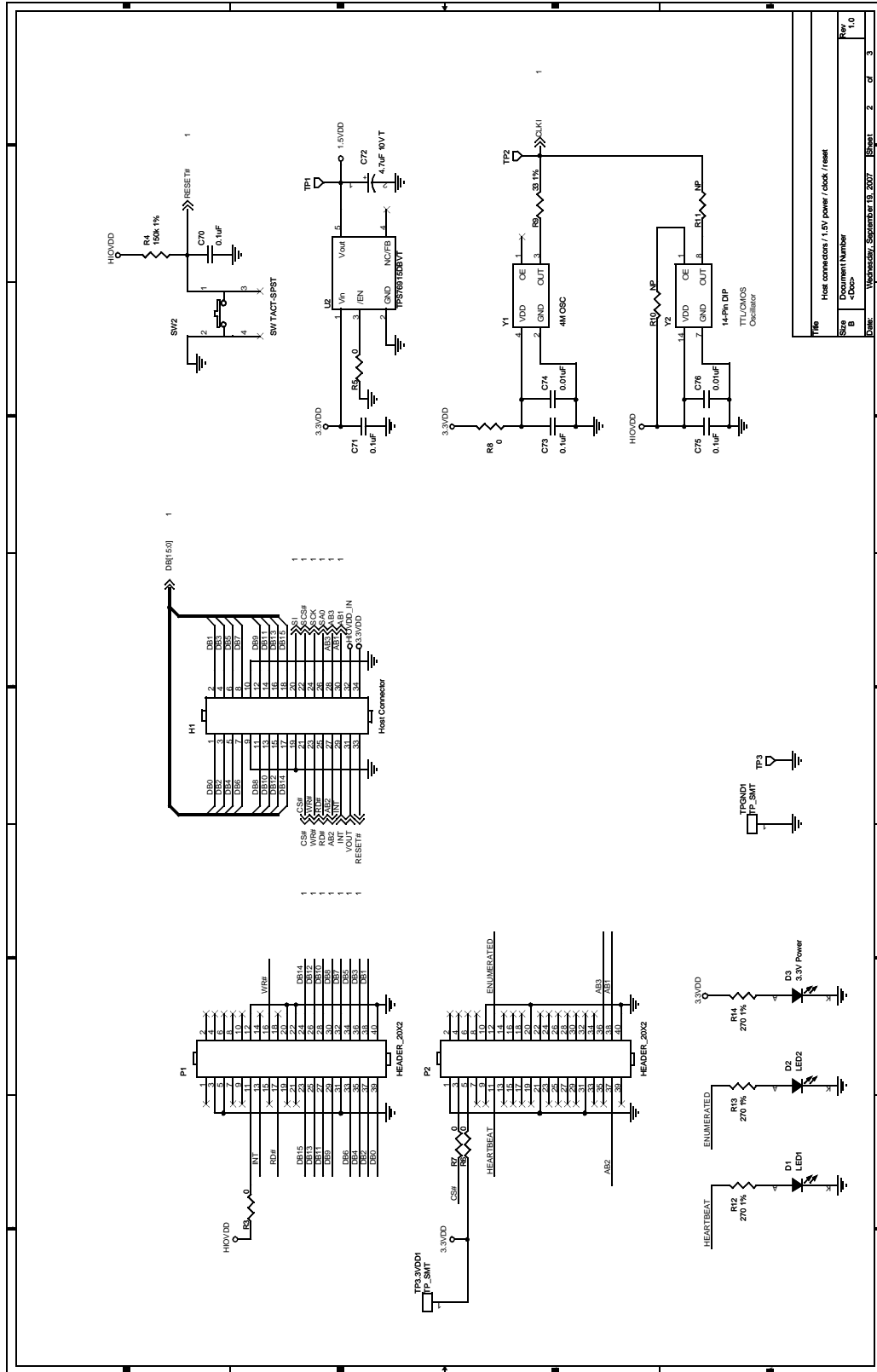

Figure 6-2: S5U13748P00C100 Schematics (2 of 3)



# Chapter 7 Board Layout

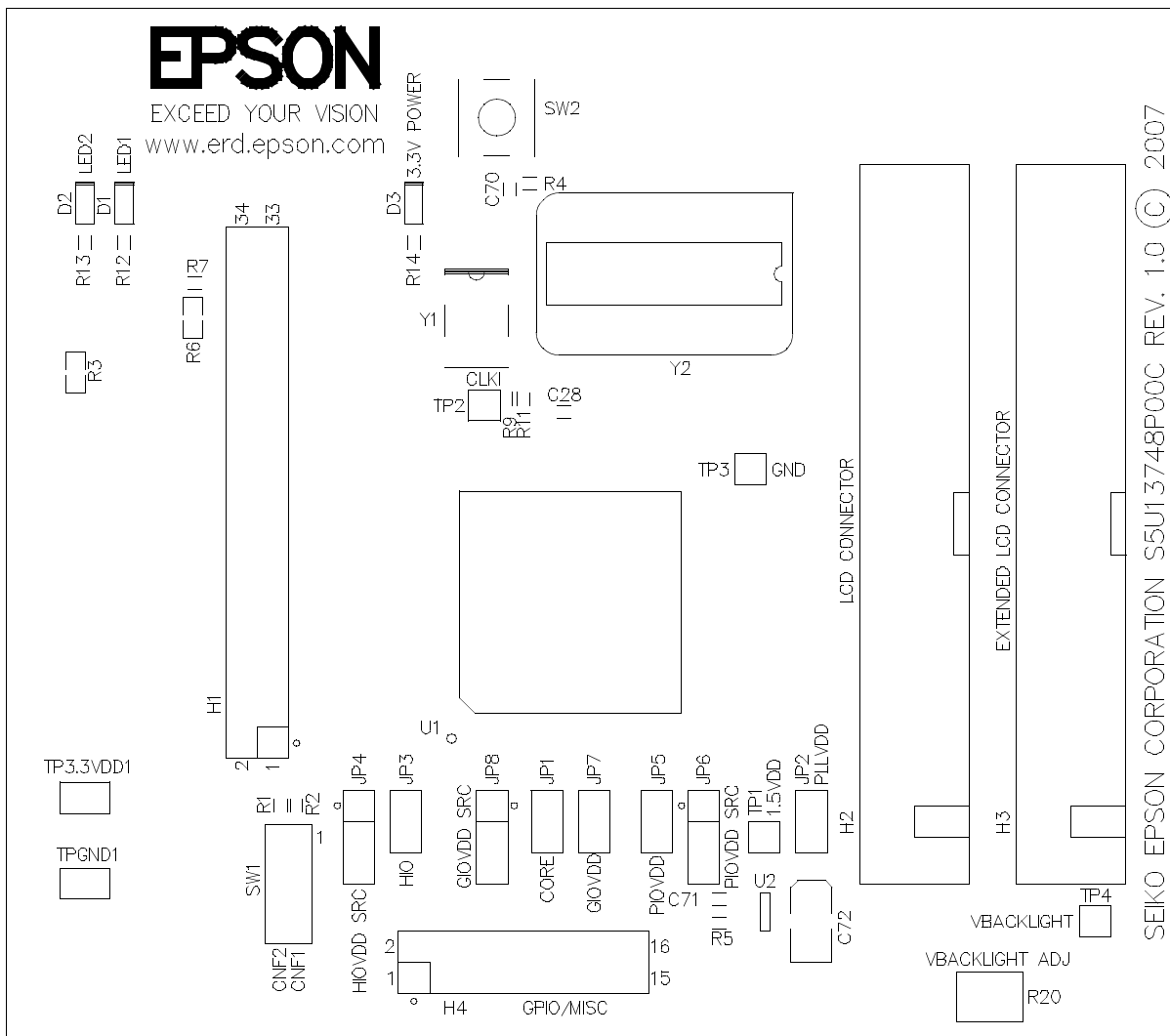

Figure 7-1: S5U13748P00C100 Board Layout - Top View

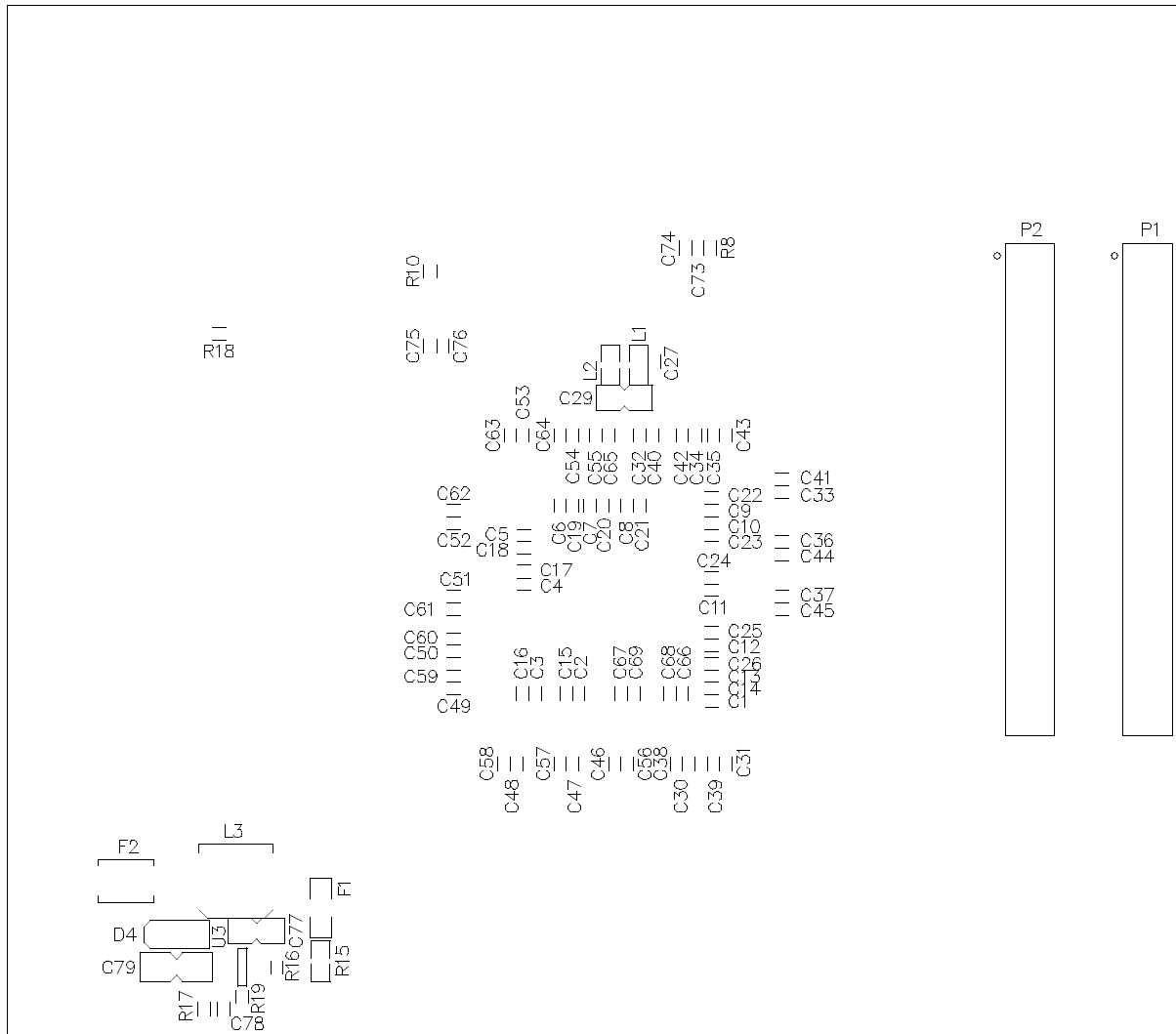

Figure 7-2: S5U13748P00C100 Board Layout - Bottom View



## Chapter 8 References

### 8.1 Documents

- Epson Research and Development, Inc., *S1D13748 Hardware Functional Specification*, document number X80A-A-001-xx.

### 8.2 Document Sources

- Epson Research and Development Website: <http://www.erd.epson.com>.

## Change Record

### **X80A-G-001-01 Revision 1.1 - Issued: January 31, 2008**

- section 2, fixed typo on-board voltage regulator should be 12~25V
- section 5, for Parts List F1 and F2 are now separate line items, F1 is now a TDK ACH32C-333-T
- section 6, for Schematic diagram 3 of 3, updated the part used for F1 to a TDK ACH32C-333-T

### **X80A-G-001-01 Revision 1.0 - Issued: December 03, 2007**

- section 2, changed voltage range for the on-board voltage regulator
- sections 3 and 4, added the Dip Switch, Jumper, and Connector location diagrams
- section 4.1.2, changed the voltage range for the step up voltage regulator to “12~25V”
- section 4.5, updated the description of the 12~25V power supply
- section 5, for the parts list changed item 10 from “MBR0530” to “MBR0540”
- section 5, for the parts list changed item 27 from quantity 2 to quantity 1 and added new item 28 for R17
- section 6, for schematic 2 of 3 changed references from “IOVDD” to “HIOVDD”
- section 6, for schematic 3 of 3 changed item description for D4, changed value for R17, and updated note about “Adjustable Step Up Power Supply...”
- section 7, added top and bottom board layouts

### **X80A-G-001-00 Revision 0.02 - Issued: September 26, 2007**

- globally change “40mA” to “100mA”
- globally change “0.5A” to “1A”
- section 5 Parts List - replace parts list
- section 6 Schematic Diagrams - replace all schematic diagrams

### **X80A-G-001-00 Revision 0.01 - Issued: September 19, 2007**

- first draft of this manual

### AMERICA

---

**EPSON ELECTRONICS AMERICA, INC.****HEADQUARTERS**

2580 Orchard Parkway  
San Jose, CA 95131, USA  
Phone: +1-800-228-3964      FAX: +1-408-922-0238

**SALES OFFICES****Northeast**

301 Edgewater Place, Suite 210  
Wakefield, MA 01880, U.S.A.  
Phone: +1-800-922-7667      FAX: +1-781-246-5443

### EUROPE

---

**EPSON EUROPE ELECTRONICS GmbH****HEADQUARTERS**

Riesstrasse 15  
80992 Munich, GERMANY  
Phone: +49-89-14005-0      FAX: +49-89-14005-110

### ASIA

---

**EPSON (CHINA) CO., LTD.**

23F, Beijing Silver Tower 2# North RD DongSanHuan  
ChaoYang District, Beijing, CHINA  
Phone: +86-10-6410-6655      FAX: +86-10-6410-7320

**SHANGHAI BRANCH**

7F, High-Tech Bldg., 900, Yishan Road,  
Shanghai 200233, CHINA  
Phone: +86-21-5423-5522      FAX: +86-21-5423-5512

**EPSON HONG KONG LTD.**

20/F., Harbour Centre, 25 Harbour Road  
Wanchai, Hong Kong  
Phone: +852-2585-4600      FAX: +852-2827-4346  
Telex: 65542 EPSCO HX

**EPSON Electronic Technology Development (Shenzhen) LTD.**

12/F, Dawning Mansion, Keji South 12th Road,  
Hi-Tech Park, Shenzhen  
Phone: +86-755-2699-3828      FAX: +86-755-2699-3838

**EPSON TAIWAN TECHNOLOGY & TRADING LTD.**

14F, No. 7, Song Ren Road,  
Taipei 110  
Phone: +886-2-8786-6688      FAX: +886-2-8786-6660

**EPSON SINGAPORE PTE., LTD.**

1 HarbourFront Place,  
#03-02 HarbourFront Tower One, Singapore 098633  
Phone: +65-6586-5500      FAX: +65-6271-3182

**SEIKO EPSON CORPORATION****KOREA OFFICE**

50F, KLI 63 Bldg., 60 Yoido-dong  
Youngdeungpo-Ku, Seoul, 150-763, KOREA  
Phone: +82-2-784-6027      FAX: +82-2-767-3677

**GUMI OFFICE**

2F, Grand B/D, 457-4 Songjeong-dong,  
Gumi-City, KOREA  
Phone: +82-54-454-6027      FAX: +82-54-454-6093

---

**SEIKO EPSON CORPORATION****SEMICONDUCTOR OPERATIONS DIVISION****IC Sales Dept.****IC International Sales Group**

421-8, Hino, Hino-shi, Tokyo 191-8501, JAPAN  
Phone: +81-42-587-5814      FAX: +81-42-587-5117