



Common Mode Filters

For ultra high-speed differential signal line (HDMI, DVI, USB3.0)

MCZ-DH Series

MCZ1210DH Type

MCZ1210DH [0504 inch]*

* Dimensions Code JIS[EIA]

REMINDERS FOR USING THESE PRODUCTS

Before using these products, be sure to request the delivery specifications.

SAFETY REMINDERS

Please pay sufficient attention to the warnings for safe designing when using these products.

REMINDERS

- The storage period is less than 12 months. Be sure to follow the storage conditions (Temperature: 5 to 40°C, Humidity: 10 to 75% RH or less).
If the storage period elapses, the soldering of the terminal electrodes may deteriorate.
- Do not use or store in locations where there are conditions such as gas corrosion (salt, acid, alkali, etc.).
- Before soldering, be sure to preheat components.
The preheating temperature should be set so that the temperature difference between the solder temperature and chip temperature does not exceed 150°C.
- Soldering corrections after mounting should be within the range of the conditions determined in the specifications.
If overheated, a short circuit, performance deterioration, or lifespan shortening may occur.
- When embedding a printed circuit board where a chip is mounted to a set, be sure that residual stress is not given to the chip due to the overall distortion of the printed circuit board and partial distortion such as at screw tightening portions.
- Self heating (temperature increase) occurs when the power is turned ON, so the tolerance should be sufficient for the set thermal design.
- Carefully lay out the coil for the circuit board design of the non-magnetic shield type.
A malfunction may occur due to magnetic interference.
- Use a wrist band to discharge static electricity in your body through the grounding wire.
- Do not expose the products to magnets or magnetic fields.
- Do not use for a purpose outside of the contents regulated in the delivery specifications.
- The products listed on this catalog are intended for use in general electronic equipment (AV equipment, telecommunications equipment, home appliances, amusement equipment, computer equipment, personal equipment, office equipment, measurement equipment, industrial robots) under a normal operation and use condition.
The products are not designed or warranted to meet the requirements of the applications listed below, whose performance and/or quality require a more stringent level of safety or reliability, or whose failure, malfunction or trouble could cause serious damage to society, person or property.
If you intend to use the products in the applications listed below or if you have special requirements exceeding the range or conditions set forth in the each catalog, please contact us.

- (1) Aerospace/Aviation equipment
- (2) Transportation equipment (cars, electric trains, ships, etc.)
- (3) Medical equipment
- (4) Power-generation control equipment
- (5) Atomic energy-related equipment
- (6) Seabed equipment
- (7) Transportation control equipment

- (8) Public information-processing equipment
- (9) Military equipment
- (10) Electric heating apparatus, burning equipment
- (11) Disaster prevention/crime prevention equipment
- (12) Safety equipment
- (13) Other applications that are not considered general-purpose applications

When designing your equipment even for general-purpose applications, you are kindly requested to take into consideration securing protection circuit/device or providing backup circuits in your equipment.

Common Mode Filters

Product compatible with RoHS directive
Halogen-free

For ultra high-speed differential signal line (HDMI, DVI, USB3.0) Compatible with lead-free solders

Overview of MCZ1210DH Type

FEATURES

- Compact multilayer common mode filter.
- Widened frequency range for differential mode transmission up to 6.0GHz while ensuring common mode impedance.
Suppresses common mode noise without influencing the high-speed differential transmission line signal.
- Characteristics impedance for differential mode is 100Ω.
Optimal for high-speed differential transmission lines, especially HDMI sink devices.

APPLICATION

- High-speed interfaces for electronic equipment (HDMI, DVI, USB3.0)
- TVs, DVCs, Mobile phones, PCs, DSCs, portable game machines, etc.

PART NUMBER CONSTRUCTION

MCZ	1210		DH	120		L2		T		A0G
Series name	LxWxT Dimensions (mm)		Product internal code	Impedance (Ω) at 100MHz		Number of lines		Packaging style		Internal code
	1210	1.25x1.0x0.5	DH	120	12	L2	2 lines	T	Taping	A0G
				500	50					
				900	90					

OPERATING TEMPERATURE RANGE, PACKAGE QUANTITY, PRODUCT WEIGHT

Type	Temperature range		Package quantity (pieces/reel)	Individual weight (mg)
	Operating temperature (°C)	Storage temperature* (°C)		
MCZ1210DH	-40 to +85	-40 to +85	4,000	3.0

* The Storage temperature range is for after the circuit board is mounted.

- RoHS Directive Compliant Product: See the following for more details related to RoHS Directive compliant products. <http://product.tdk.com/en/environment/rohs/>
- Halogen-free: Indicates that Cl content is less than 900ppm, Br content is less than 900ppm, and that the total Cl and Br content is less than 1500ppm.

 Please be sure to request delivery specifications that provide further details on the features and specifications of the products for proper and safe use. Please note that the contents may change without any prior notice due to reasons such as upgrading.

MCZ1210DH Type

RECOMMENDED REFLOW PROFILE

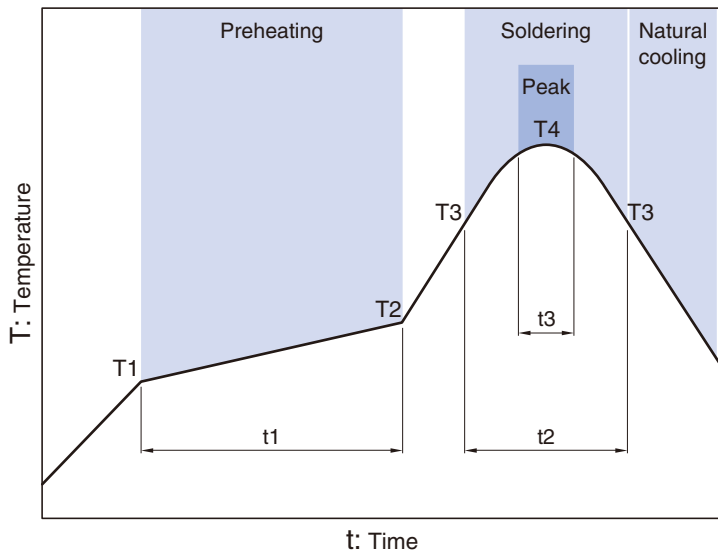

Preheating			Soldering		Peak	
Temp.	Temp.	Time	Temp.	Time	Temp.	Time
T1	T2	t1	T3	t2	T4	t3
150°C	180°C	60 to 120s	230°C	30 to 60s	250 to 260°C	10s max.

 Please be sure to request delivery specifications that provide further details on the features and specifications of the products for proper and safe use. Please note that the contents may change without any prior notice due to reasons such as upgrading.

MCZ1210DH Type

SHAPE & DIMENSIONS

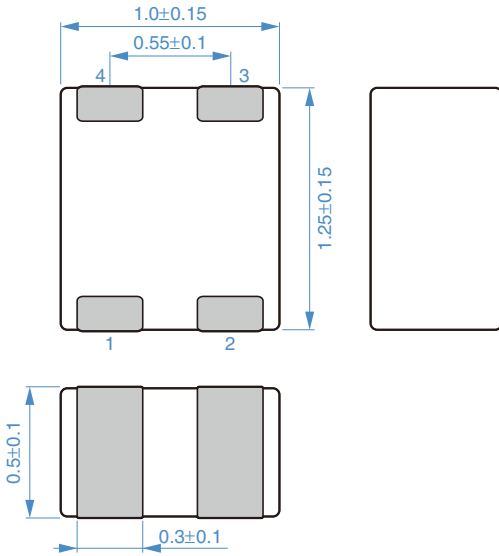

Dimensions in mm

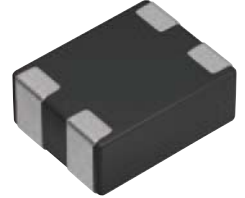

RECOMMENDED LAND PATTERN

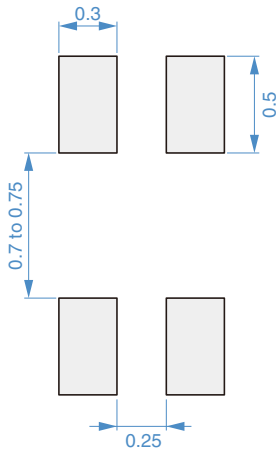

Dimensions in mm

CIRCUIT DIAGRAM

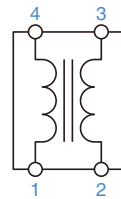

• No polarity

MCZ1210DH Type

ELECTRICAL CHARACTERISTICS

CHARACTERISTICS SPECIFICATION TABLE

Common mode impedance		DC resistance	Rated current	Rated voltage	Insulation resistance	Part No.
[100MHz] (Ω)	Tolerance	[1 line] (Ω)max.	(mA)max.	(V)max.	(M Ω)min.	
12	$\pm 5\Omega$	1.50	100	5	10	MCZ1210DH120L2TA0G
50	$\pm 25\%$	2.50	100	5	10	MCZ1210DH500L2TA0G
90	$\pm 25\%$	3.00	100	5	10	MCZ1210DH900L2TA0G

Measurement equipment

Measurement item	Product No.	Manufacturer
Common mode impedance	E4991A+16192A	Keysight Technologies
DC resistance	Type-7561	Yokogawa
Insulation resistance	4339B	Keysight Technologies

* Equivalent measurement equipment may be used.

IMPEDANCE VS. FREQUENCY CHARACTERISTICS

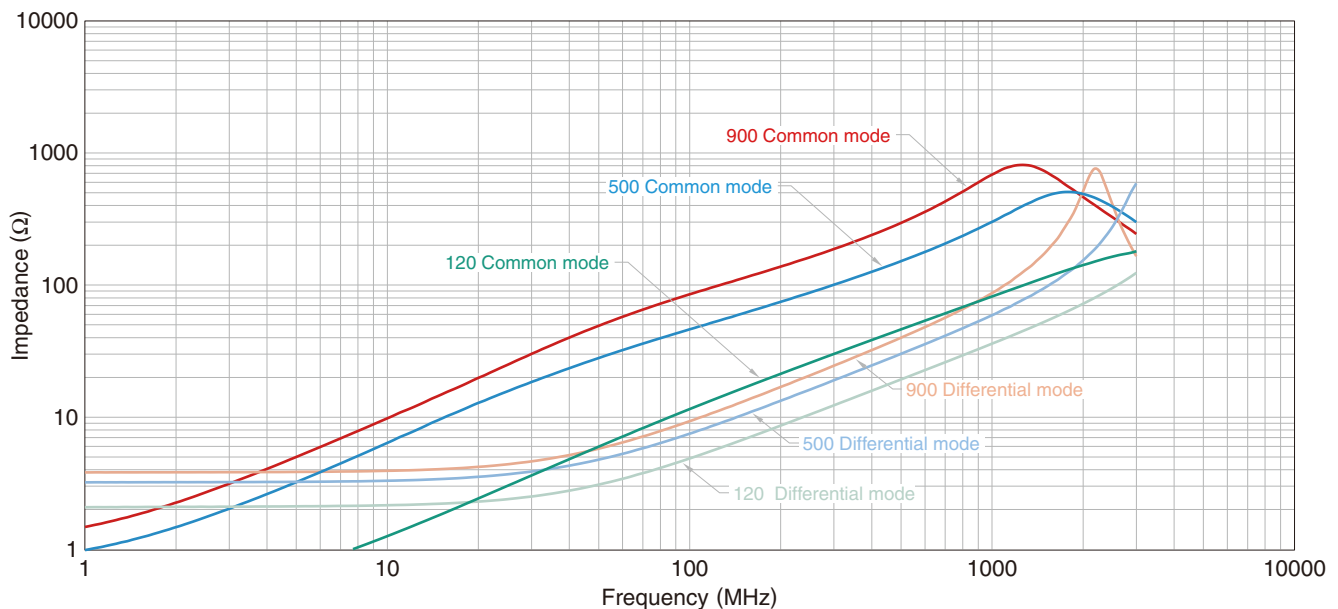

Measurement equipment

Product No.	Manufacturer
E4991A+16192A	Keysight Technologies

* Equivalent measurement equipment may be used.

Please be sure to request delivery specifications that provide further details on the features and specifications of the products for proper and safe use. Please note that the contents may change without any prior notice due to reasons such as upgrading.

MCZ1210DH Type

PACKAGING STYLE

REEL DIMENSIONS

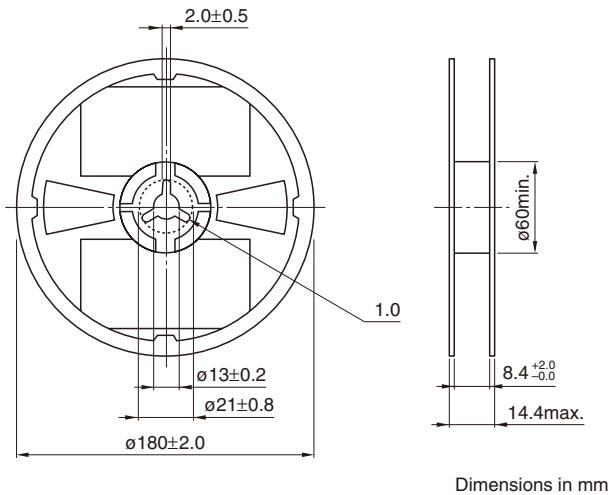

Dimensions in mm

TAPE DIMENSIONS

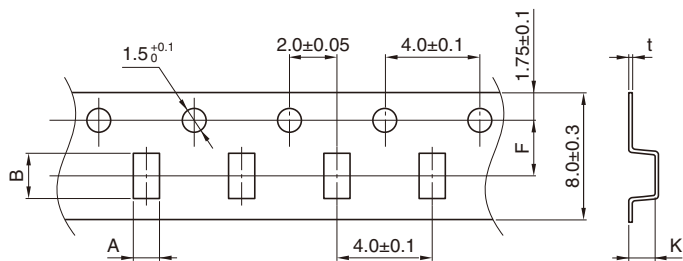

Dimensions in mm

Type	A	B	K	t
MCZ1210DH	1.15±0.1	1.4±0.1	1.0max.	0.25±0.05

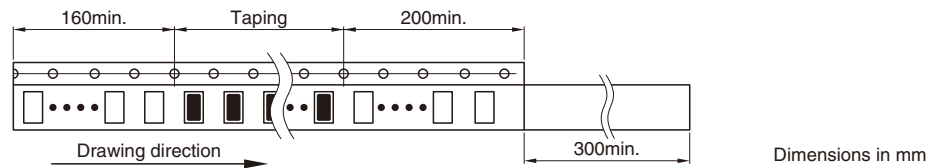

Dimensions in mm

 Please be sure to request delivery specifications that provide further details on the features and specifications of the products for proper and safe use. Please note that the contents may change without any prior notice due to reasons such as upgrading.