



**GPS / GNSS Receiver Master
Development System
User's Guide**

Wireless made simple®

 **Warning:** Some customers may want Linx radio frequency (“RF”) products to control machinery or devices remotely, including machinery or devices that can cause death, bodily injuries, and/or property damage if improperly or inadvertently triggered, particularly in industrial settings or other applications implicating life-safety concerns (“Life and Property Safety Situations”).

NO OEM LINX REMOTE CONTROL OR FUNCTION MODULE SHOULD EVER BE USED IN LIFE AND PROPERTY SAFETY SITUATIONS. No OEM Linx Remote Control or Function Module should be modified for Life and Property Safety Situations. Such modification cannot provide sufficient safety and will void the product’s regulatory certification and warranty.

Customers may use our (non-Function) Modules, Antenna and Connectors as part of other systems in Life Safety Situations, but only with necessary and industry appropriate redundancies and in compliance with applicable safety standards, including without limitation, ANSI and NFPA standards. It is solely the responsibility of any Linx customer who uses one or more of these products to incorporate appropriate redundancies and safety standards for the Life and Property Safety Situation application.

Do not use this or any Linx product to trigger an action directly from the data line or RSSI lines without a protocol or encoder/decoder to validate the data. Without validation, any signal from another unrelated transmitter in the environment received by the module could inadvertently trigger the action.

All RF products are susceptible to RF interference that can prevent communication. RF products without frequency agility or hopping implemented are more subject to interference. This module does not have a frequency hopping protocol built in.

Do not use any Linx product over the limits in this data guide. Excessive voltage or extended operation at the maximum voltage could cause product failure. Exceeding the reflow temperature profile could cause product failure which is not immediately evident.

Do not make any physical or electrical modifications to any Linx product. This will void the warranty and regulatory and UL certifications and may cause product failure which is not immediately evident.

Table of Contents

- 1 [Introduction](#)
- 2 [Ordering Information](#)
- 3 [Receiver Development Board](#)
- 3 [Board Objects](#)
- 4 [Initial Setup](#)
- 4 [Troubleshooting](#)
- 5 [The Prototyping Area](#)
- 6 [The Receiver Section](#)
- 7 [The USB Section](#)
- 8 [The Display Section](#)
- 9 [Master Development Software](#)
- 10 [Schematics](#)

GPS/GNSS Master Development System

User's Guide

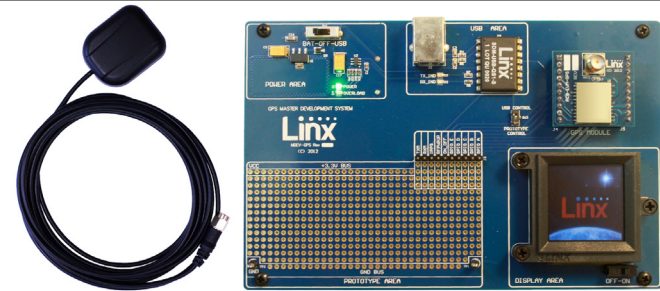

Figure 1: GPS / GNSS Master Development System

Introduction

The Linx GPS and GNSS modules offer a simple, efficient and cost-effective method of adding GPS or GNSS capabilities to any product. The Master Development System is intended to give a designer all the tools necessary to correctly incorporate the modules into an end product. The development boards themselves serve several important functions:

- **Rapid Module Evaluation:** The boards allow the performance of the modules to be evaluated quickly in a user's environment.
- **Application Development:** An onboard prototyping area allows for the development of custom circuits directly on the development board. All signal lines are available on a header for easy access.
- **Design Benchmark:** The boards provide a known benchmark against which the performance of a custom design may be judged.

The Master Development System includes one assembled development board, one receiver module on an evaluation board, one spare receiver module for use on your first prototype, one SH Series active GPS antenna, 4 AAA batteries and full documentation.

Ordering Information

Ordering Information	
Part Number	Description
MDEV-GPS-R4	R4 Series Master Development System
MDEV-GPS-F4	F4 Series Master Development System
MDEV-GPS-RM	RM Series Master Development System
MDEV-GPS-FM	FM Series Master Development System
MDEV-GNSS-GM	GM Series Master Development System
MDEV-GNSS-TM	TM Series Master Development System
EVM-GPS-R4	R4 Series Evaluation Module
EVM-GPS-F4	F4 Series Evaluation Module
EVM-GPS-RM	RM Series Evaluation Module
EVM-GPS-FM	FM Series Evaluation Module
EVM-GNSS-GM	GM Series Evaluation Module
EVM-GNSS-TM	TM Series Evaluation Module
RXM-GPS-R4-x	R4 Series GPS Receiver Module
RXM-GPS-F4-x	F4 Series GPS Receiver Module
RXM-GPS-RM-x	RM Series GPS Receiver Module
RXM-GPS-FM-x	FM Series GPS Receiver Module
RXM-GNSS-GM-x	GM Series GNSS Receiver Module
RXM-GNSS-TM-x	TM Series GNSS Receiver Module

Figure 2: Ordering Information

Receiver Development Board

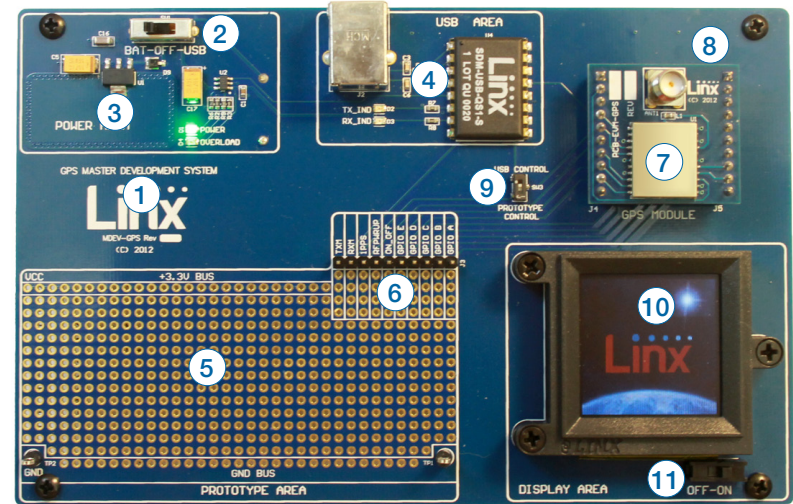

Figure 3: Receiver Development Board

Board Objects

1. Four AAA Batteries (on back)
2. Power Switch
3. Voltage Regulator
4. USB Interface Module
5. Prototype Area
6. Break-Out Header
7. Receiver Evaluation Board
8. CR2032 Backup Battery (on back)
9. Module Data Routing Switch
10. OLED Display
11. OLED Display Power Switch

Initial Setup

Unpack the development system and install the AAA and coin-cell batteries. Connect the external GPS antenna. The power switch selects between the battery pack or USB power if the board is plugged into a USB bus. To use the display, turn the OLED display power switch on. The development board is now ready for use. After turning on the power, the module determines its current position. Please note, the time required for an initial fix or after long periods of storage is considerably greater than in subsequent operation. Please refer to the module's data guide for complete information regarding Time-To-First-Fix (TTFF). To protect the display and extend its life, turn off the display before turning off the board.

Troubleshooting

If the boards fail to work out of the box, then try the following:

- Check the batteries to make sure they are not dead
- Check to make sure that the power switch is in the correct position
- Check that the antenna is installed correctly
- Check that the data routing switch is set appropriately

If all of these appear to be in order, please call +1 800 736 6677 or e-mail techsupport@linxtechnologies.com for technical support.

The Prototyping Area

In addition to its evaluation functions, the board may also be used for actual product development. It features a prototyping area to facilitate the addition of application-specific circuitry. The prototyping area contains a large area of plated through-holes so that external circuitry can be placed on the board. The holes are set at 0.100" on center with a 0.040" diameter, making it easy to add most industry-standard SIP and DIP packages.

External circuitry can be easily interfaced with the receiver through the breakout header (J3) on the upper right of the prototyping area. A switch controls the routing of data into the receiver module. By default the switch is set for operation with the on-board USB module. When communicating with the module from the prototyping area this switch should be set to Prototype Control. At the bottom of the prototyping area is a row connected to ground and at the top is a row connected to the 3.3V power supply.

Note: The on-board 3.3-volt regulator has approximately 300mA of headroom available for additional circuitry. If added circuitry requires a higher current, the user must add an additional regulator to the prototype area or power the board from an external supply.

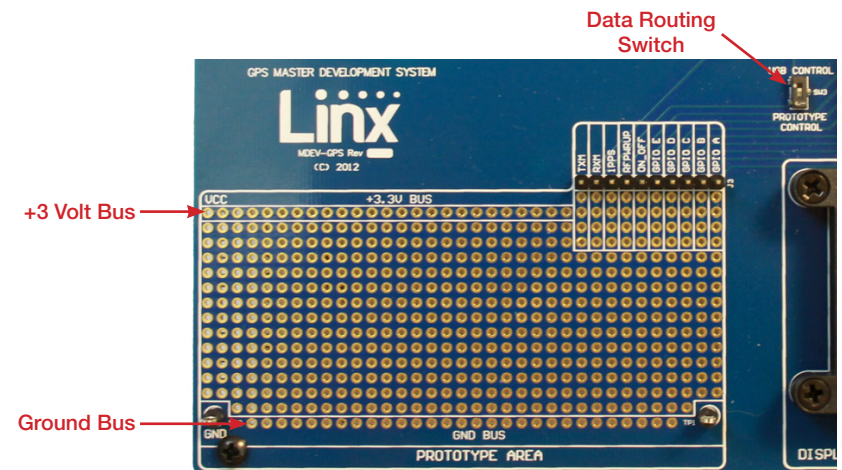

Figure 4: The Development Board Prototyping Area

The Receiver Section

The receiver module is mounted on an evaluation board which plugs into headers on the main development board. The evaluation board has an SMA antenna connector to allow the attachment of many different styles of GPS antennas, including the included SH Series active GPS antenna. Each receiver module has its own evaluation board, but all of them are designed to fit into the same socket on the main board.

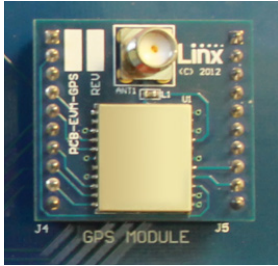

Figure 5: The Development Board Receiver Section

On the bottom of the main board is a CR2032 coin cell battery that provides power to the Real Time Clock (RTC) and SRAM when the receiver is powered down. This allows the receiver to start up and obtain a position fix faster. This cell provides about two years of operation.

The USB Section

The development board features a Linx QS Series USB module for interface to a PC. This allows the board to be used with the supplied development software or with custom software developed by the user.

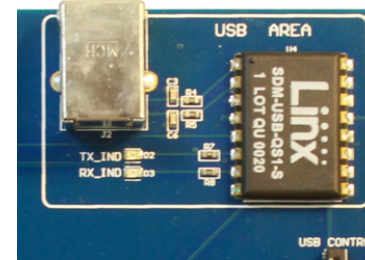

Figure 6: The Development Board USB Section

Drivers for the USB module are included on the software CD in the kit or may be downloaded from www.linxtechnologies.com. Additional information on using the QS Series USB module can also be found on the website.

The USB connection also allows the board to be powered by the USB bus instead of batteries. This can be convenient during development to eliminate the need for frequent battery replacement.

The Display Section

The Master Development System features an OLED screen that displays the navigation information from the receiver module. This allows the development board to act as a stand-alone evaluation system without the need for any additional software.



Figure 7: The Development Board Display Section

The display is driven by an on-board microcontroller located under the display. Data from the receiver module is connected directly to this microcontroller. The microcontroller receives data at the receiver's default 9,600bps.

Note: If the receiver's baud rate is changed, it will not be able to communicate with the microcontroller.

The display and microcontroller pull about 100mA when fully powered, so a power switch is supplied to deactivate the display area when not in use, saving battery life. To protect the display and extend its life, be sure to turn the display section off before turning off the main power to the board.

Master Development Software

The development system is supplied with Windows-based software that communicates with the development board through the USB module. This software displays the information from the receiver module in the different NMEA formats and the satellite information, signal strength, and positions are displayed graphically. If the PC is connected to the internet, the software plots the current location on Google Maps. Full details are in the software's User's Guide.

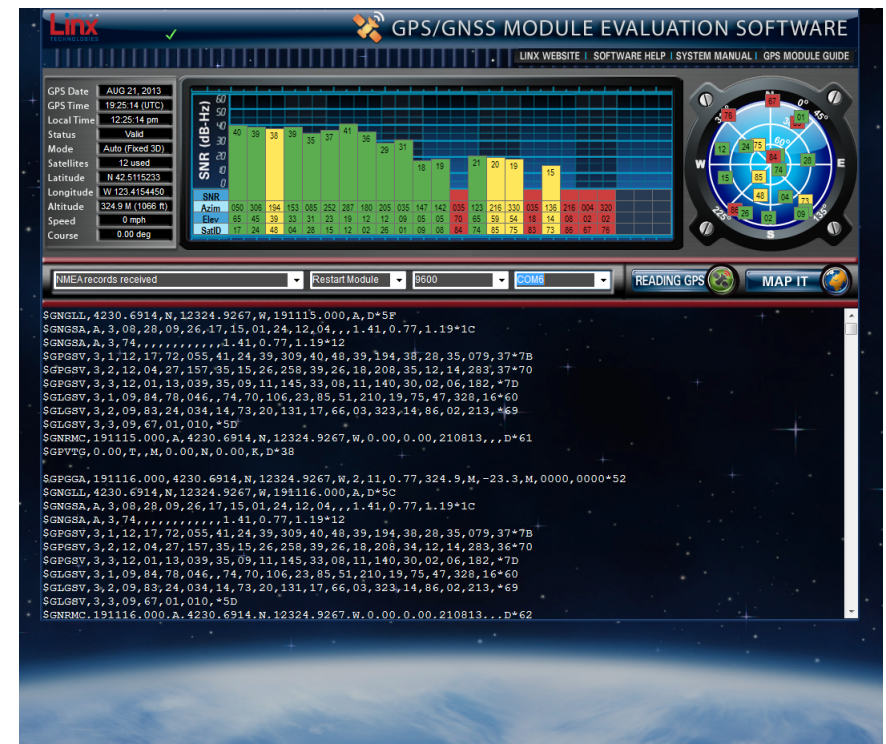

Figure 8: Master Development Software

Schematics

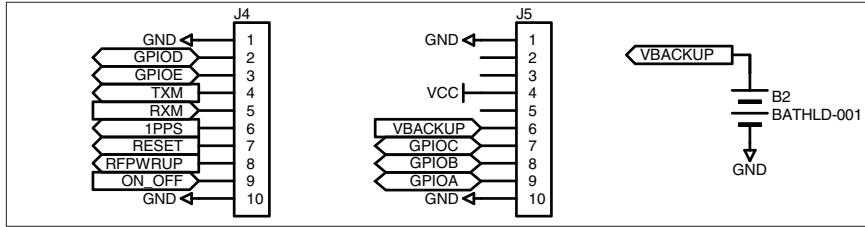

Figure 9: Receiver Section Schematic

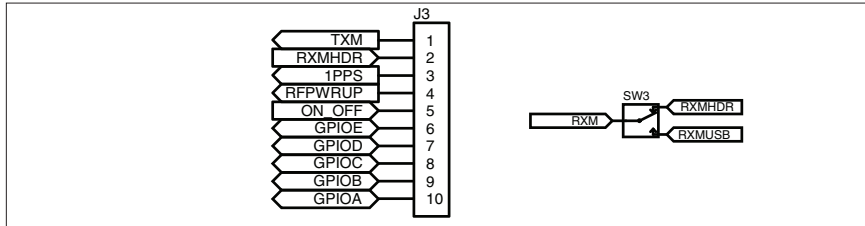

Figure 10: Header Section Schematic

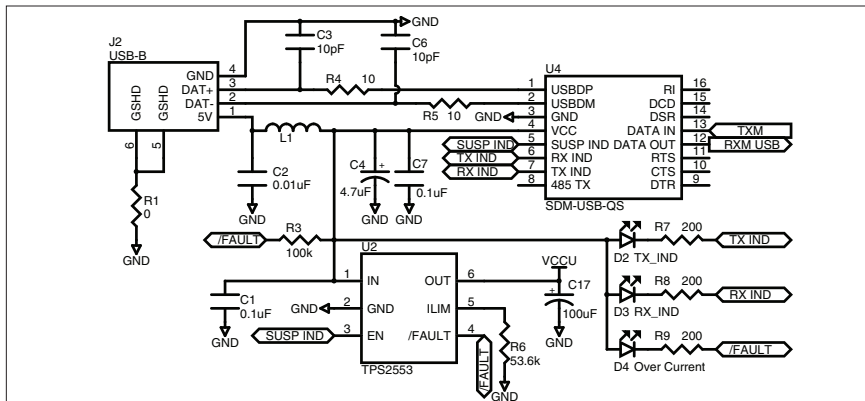

Figure 11: USB Section Schematic

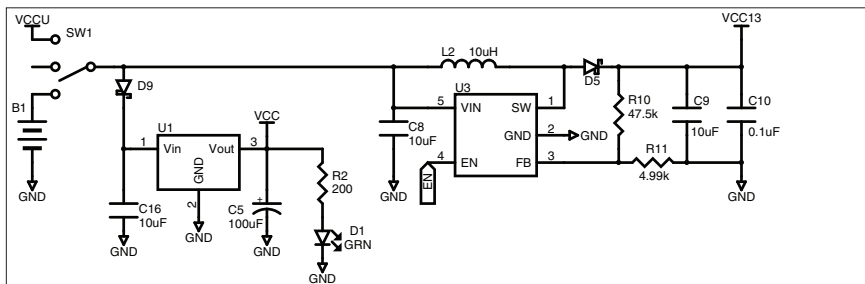

Figure 12: Power Supply Schematic

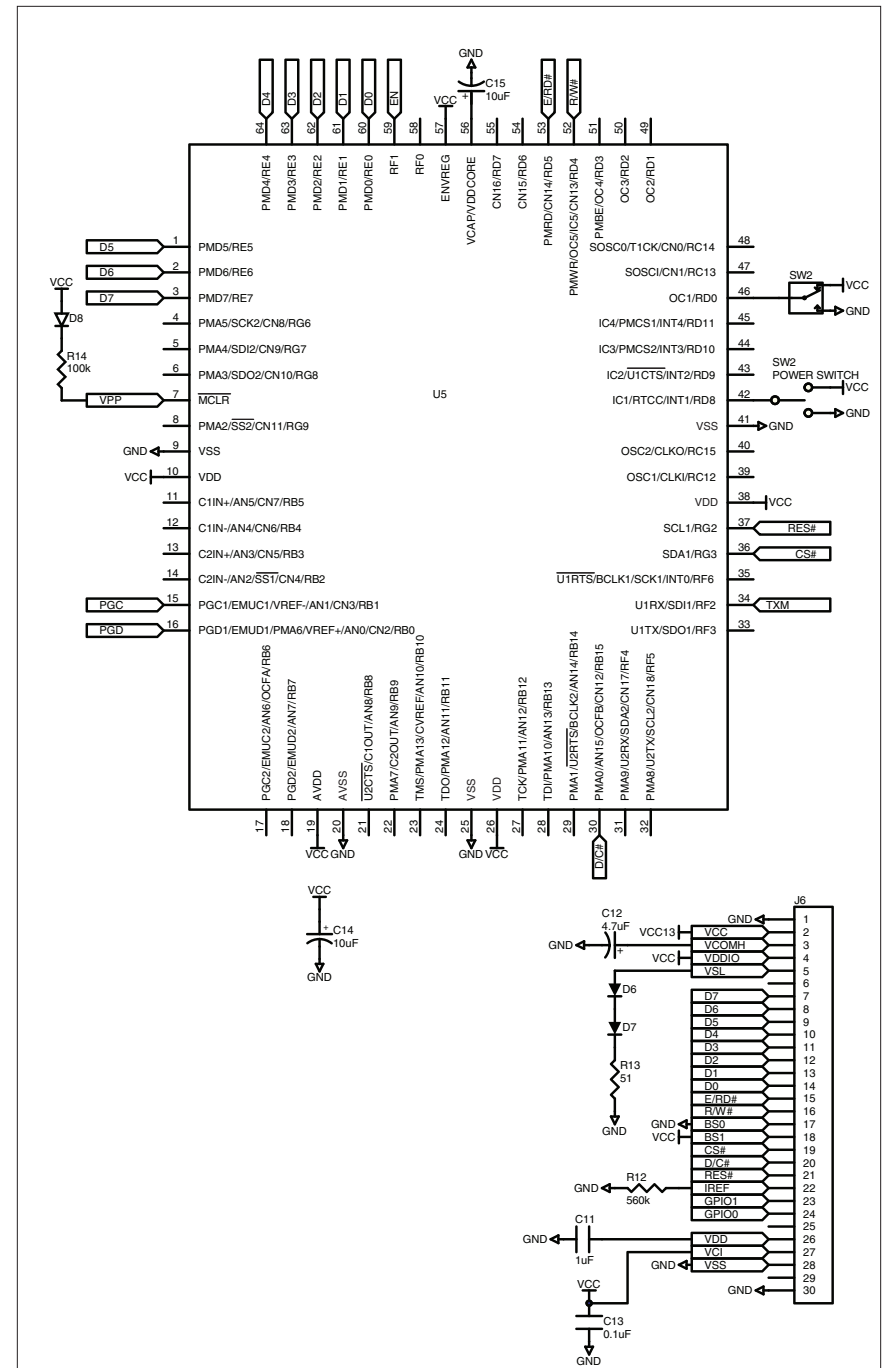

Figure 13: Display Section Schematic



Linx Technologies
159 Ort Lane
Merlin, OR, US 97532

Phone: +1 541 471 6256
Fax: +1 541 471 6251

www.linxtechnologies.com

Disclaimer

Linx Technologies is continually striving to improve the quality and function of its products. For this reason, we reserve the right to make changes to our products without notice. The information contained in this Data Guide is believed to be accurate as of the time of publication. Specifications are based on representative lot samples. Values may vary from lot-to-lot and are not guaranteed. "Typical" parameters can and do vary over lots and application. Linx Technologies makes no guarantee, warranty, or representation regarding the suitability of any product for use in any specific application. It is the customer's responsibility to verify the suitability of the part for the intended application. **NO LINX PRODUCT IS INTENDED FOR USE IN ANY APPLICATION WHERE THE SAFETY OF LIFE OR PROPERTY IS AT RISK.**

Linx Technologies **DISCLAIMS ALL WARRANTIES OF MERCHANTABILITY AND FITNESS FOR A PARTICULAR PURPOSE. IN NO EVENT SHALL LINX TECHNOLOGIES BE LIABLE FOR ANY OF CUSTOMER'S INCIDENTAL OR CONSEQUENTIAL DAMAGES ARISING IN ANY WAY FROM ANY DEFECTIVE OR NON-CONFORMING PRODUCTS OR FOR ANY OTHER BREACH OF CONTRACT BY LINX TECHNOLOGIES.** The limitations on Linx Technologies' liability are applicable to any and all claims or theories of recovery asserted by Customer, including, without limitation, breach of contract, breach of warranty, strict liability, or negligence. Customer assumes all liability (including, without limitation, liability for injury to person or property, economic loss, or business interruption) for all claims, including claims from third parties, arising from the use of the Products. The Customer will indemnify, defend, protect, and hold harmless Linx Technologies and its officers, employees, subsidiaries, affiliates, distributors, and representatives from and against all claims, damages, actions, suits, proceedings, demands, assessments, adjustments, costs, and expenses incurred by Linx Technologies as a result of or arising from any Products sold by Linx Technologies to Customer. Under no conditions will Linx Technologies be responsible for losses arising from the use or failure of the device in any application, other than the repair, replacement, or refund limited to the original product purchase price. Devices described in this publication may contain proprietary, patented, or copyrighted techniques, components, or materials. Under no circumstances shall any user be conveyed any license or right to the use or ownership of such items.

©2015 Linx Technologies. All rights reserved.

The stylized Linx logo, Wireless Made Simple, WISE, CipherLinx and the stylized CL logo are trademarks of Linx Technologies.