

Features

Regulated Converter

- Wide input range 85-264VAC
- Standby mode optimized PSU (ENER Lot 6)
- Ultra-high efficiency over entire load range
- Operating temperature range: -40°C to +85°C
- Class II installations (without FG)
- EMC compliant without external components
- No load power consumption 40mW typ.

RECOM

AC/DC Converter

RAC20-K

20 Watt
2" x 1"
Single and Dual Output

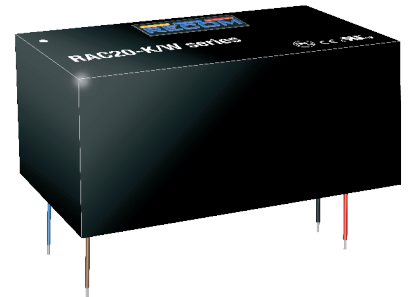

IEC/EN62368-1 certified
UL62368-1 certified
CAN/CSA-C22.2 No. 62368-1-14 certified
IEC/EN60335 certified
IEC/EN61558-1 certified
IEC/EN61558-2-16 certified
IEC/EN61204-3 compliant
EN55032/14 compliant
EN55024 compliant
CB Report

Description

The RAC20-K series are highly efficient PCB-mount power conversion modules with ultra-low energy losses especially in light load conditions, making them a benchmark for always-on and standby mode operations, which are typically coming along with IoT and smart applications. The power supply units cover worldwide mains input range of 85VAC up to 264VAC and come with international safety certifications for industrial, AV and ITE as well as household standards. These AC/DC modules operate in a temperature range of -40°C to +85°C and offer fully protected single or dual outputs as well as EMC class B compliance without the need of any external components.

Selection Guide

| Part Number | Input Voltage Range [VAC] | Output Voltage [VDC] | Output Current [mA] | Efficiency typ ⁽¹⁾ [%] | Max. Capacitive Load ⁽²⁾ [µF] |
|---------------------------|---------------------------|----------------------|---------------------|-----------------------------------|--|
| RAC20-05SK ⁽³⁾ | 85-264 | 5 | 4000 | 84 | 10000 |
| RAC20-12SK ⁽³⁾ | 85-264 | 12 | 1670 | 86 | 8000 |
| RAC20-15SK ⁽³⁾ | 85-264 | 15 | 1333 | 86 | 1500 |
| RAC20-24SK ⁽³⁾ | 85-264 | 24 | 840 | 85 | 1000 |
| RAC20-48SK ⁽³⁾ | 85-264 | 48 | 420 | 85 | 330 |
| RAC20-12DK | 85-264 | ±12 | ±833 | 84 | ±1200 |
| RAC20-15DK | 85-264 | ±15 | ±670 | 84 | ±1000 |

Notes:

Note1: Efficiency is tested at 230VAC input and constant resistive load at +25°C ambient

Note2: Max Cap Load is tested at nominal input and full resistive load

Model Numbering



Notes:

Note3: Add suffix „W“ for wired version (only single output) without suffix, standard pin version

Ordering Examples:

| | | | | |
|--------------|-------|--------|---------------|----------------------|
| RAC20-05SK | 5Watt | 5Vout | Single Output | standard pin version |
| RAC20-05SK/W | 5Watt | 5Vout | Single Output | wired version |
| RAC20-12DK | 5Watt | 12Vout | Dual Output | standard pin version |

Specifications (measured @ Ta= 25°C, nom. Vin, full load and after warm-up unless otherwise stated)

BASIC CHARACTERISTICS

| Parameter | Condition | Min. | Typ. | Max. |
|--|--|------------------|--------------|----------------------|
| Internal Input Filter | | | | Pi type |
| Input Voltage Range ^(4,5) | nom. Vin= 230VAC | 85VAC 120VDC | 230VAC | 264VAC 370VDC |
| Input Current | 115VAC 230VAC | | | 450mA 400mA |
| Inrush Current | cold start at +25°C | 115VAC 230VAC | | 20A 40A |
| No Load Power Consumption | 230VAC | | 40mW | |
| ErP Lot 6 Standby Mode Conformity (Output Load Capability) | 0.5W Input Power = 1.0W 2.0W | | | 0.3W 0.7W 1.6W |
| Input Frequency Range | AC Input | 47Hz | | 63Hz |
| Minimum Load ⁽⁷⁾ | single dual (required for regulation on both outputs) | 0% | 10% | |
| Power Factor | 115VAC 230VAC | 0.6 0.5 | | |
| Start-up Time | | | 150ms | |
| Rise Time | | | 40ms | |
| Hold-up Time | 115VAC 230VAC | | 15ms 90ms | |
| Internal Operating Frequency | | | | 100kHz |
| Output Ripple and Noise ⁽⁶⁾ | 20MHz BW | | 100mVp-p | |

Notes:

Note4: The products were submitted for safety files at AC-Input operation

Note5: Refer to "Line Derating"

Note6: Measurements are made with a 1.0µF MLCC across output (low ESR)

Efficiency vs. Load

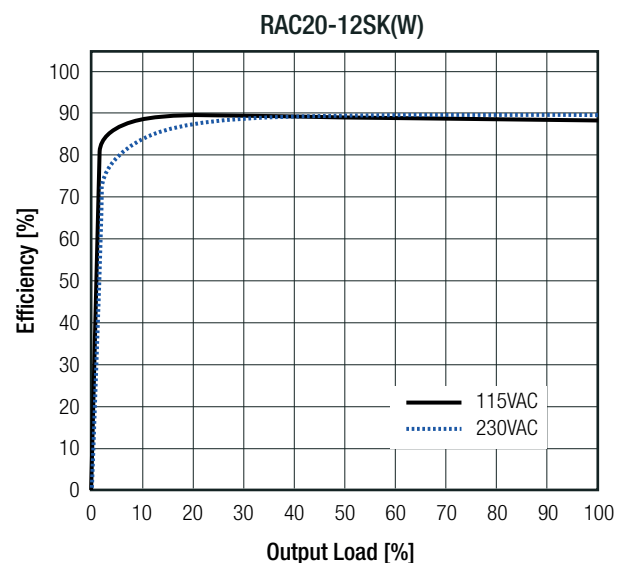
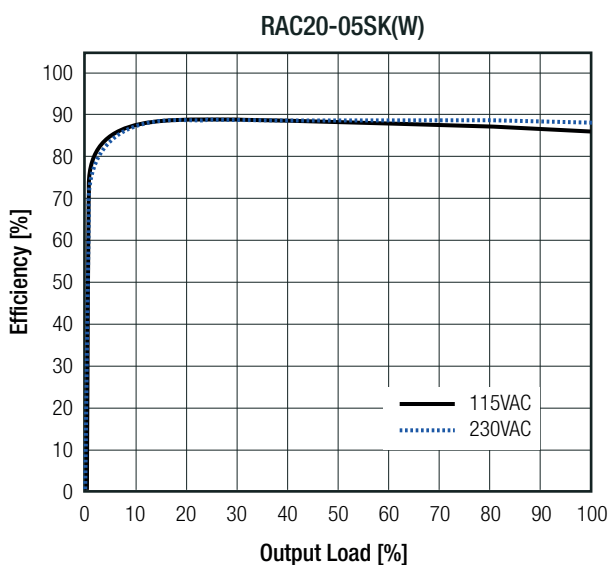

continued on next page

Specifications (measured @ Ta= 25°C, nom. Vin, full load and after warm-up unless otherwise stated)

Efficiency vs. Load



REGULATIONS

| Parameter | Condition | Value |
|--------------------------------|---------------------------------------|-------------------------|
| Output Accuracy | | ±2.0% typ. |
| Line Regulation | low line to high line | ±0.5% typ. |
| Load Regulation ⁽⁷⁾ | 10% to 100% load | ±2.0% typ. |
| Cross Regulation | dual output only | ±10.0% typ. |
| Transient Response | 25% load step change recovery time | 4.0% max. 500µs typ. |

Notes:

Note7: Operation below 10% load will not harm the converter, but specifications may not be met

Deviation vs. Load

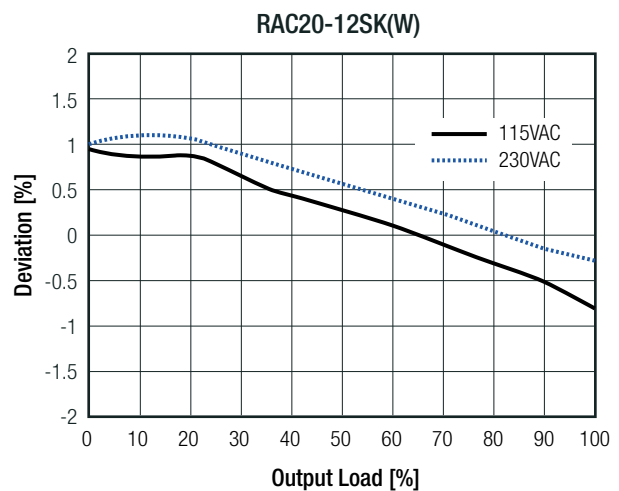
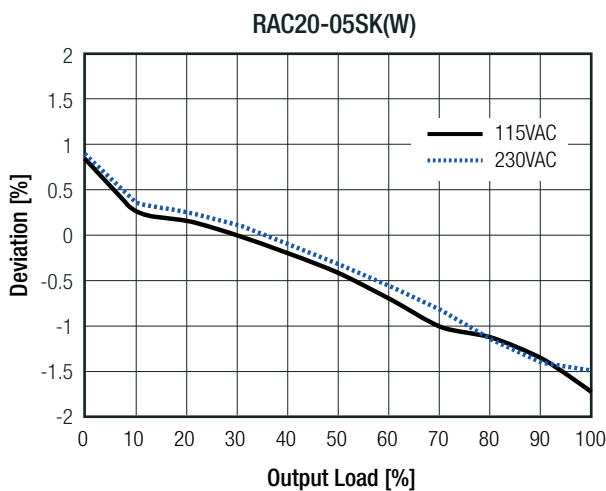

continued on next page

Specifications (measured @ Ta= 25°C, nom. Vin, full load and after warm-up unless otherwise stated)

Deviation vs. Load



PROTECTIONS

| Parameter | Type | Value |
|----------------------------------|-------------|-----------------------------|
| Input Fuse ⁽⁸⁾ | internal | T3.15A, slow blow type |
| Short Circuit Protection (SCP) | below 100mΩ | hiccup, auto recovery |
| Over Voltage Protection (OVP) | | 150% - 195%, latch off mode |
| Over Current Protection (OCP) | | 110% - 130%, hiccup mode |
| Over Voltage Category | | OVCII |
| Class of Equipment | | Class II |
| Isolation Voltage ⁽⁹⁾ | I/P to O/P | tested for 1 minute |
| Isolation Resistance | | V _{iso} = 500VDC |
| Isolation Capacitance | | 100pF max. |
| Insulation Grade | | reinforced |
| Leakage Current | | 0.25mA max. |

Notes:

Note8: Refer to local safety regulations if input over-current protection is also required

Note9: For repeat Hi-Pot testing, reduce the time and/or the test voltage

ENVIRONMENTAL

| Parameter | Condition | Value |
|-----------------------------|----------------------------------|--|
| Operating Temperature Range | @ natural convection 0.1m/s | full load: -40°C to +55°C |
| | | refer to derating graph: -40°C to +85°C |
| Maximum Case Temperature | | +95°C |
| Temperature Coefficient | | 0.05%/K |
| Operating Altitude | | 3000m |
| Operating Humidity | non-condensing | 20% - 90% RH max. |
| IP Rating | | IP20 |
| Pollution Degree | | PD2 |
| Vibration | according to MIL-STD-202G | 10-500Hz, 2G 10min./1cycle, period 60min. along x,y,z axes |
| Design Lifetime | +25°C | 130 x 10 ³ hours |
| | +55°C | 16 x 10 ³ hours |
| MTBF | according to MIL-HDBK-217F, G.B. | +25°C |
| | | +55°C |
| | | >450 x 10 ³ hours |
| | | >56 x 10 ³ hours |

continued on next page

Specifications (measured @ Ta= 25°C, nom. Vin, full load and after warm-up unless otherwise stated)

Derating Graph

(@ Chamber and natural convection 0.1 m/s)

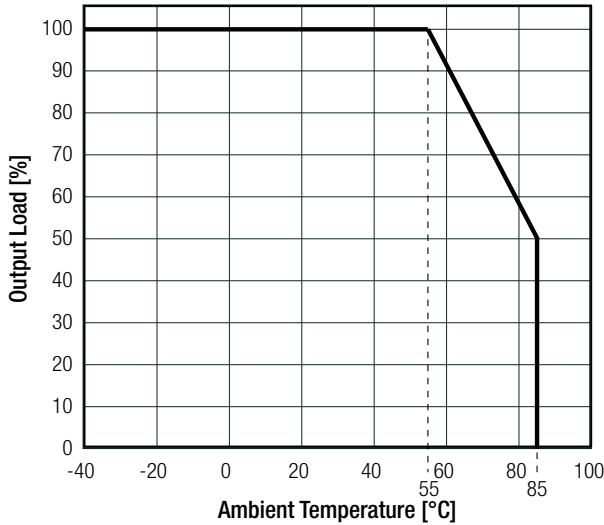

Line Derating



SAFETY AND CERTIFICATIONS

| Certificate Type (Safety) | Report / File Number | Standard |
|--|----------------------|---|
| Audio/Video, information and communication technology equipment - Safety requirements | E224736 | UL62368-1, 2nd Edition, 2014 CAN/CSA C22.2 Nr. 62368-1-14, 2nd Ed. 2014 |
| Audio/Video, information and communication technology equipment - Safety requirements (CB Scheme) | E491408-A6008-CB-1 | IEC62368-1:2014 2nd Edition |
| Audio/Video, information and communication technology equipment - Safety requirements (LVD) | | EN62368-1:2014 + A11:2017 |
| Household and similar electrical appliances – Safety – Part 1: General requirements | LCS180508046AS | IEC60335-1:2010 + AMD2:2016 + COR1:2016 EN60335-1:2012 + A11:2014 + A13:2017 |
| Safety of power transformers, power supplies, reactors and similar products for supply voltages up to 1100 V (CB Scheme) | 50198090 001 | IEC61558-1:2005 2nd Edition + A1:2009 |
| Safety of power transformers, power supplies, reactors and similar products for supply voltages up to 1100 V | | EN61558-1:2005 + A1:2009 |
| Safety of power transformers, power supplies, reactors and similar products for supply voltages up to 1100 V Part 2: Particular requirements (CB Scheme) | 50198090 001 | IEC61558-2-16:2009 1st Edition + A1:2013 |
| Safety of power transformers, power supplies, reactors and similar products for supply voltages up to 1100 V Part 2: Particular requirements | | EN61558-2-16:2009 + A1:2013 |
| RoHS2+ | | RoHS-2011/65/EU + AM-2015/863 |

| EMC Compliance | Condition | Standard / Criterion |
|---|---|--|
| Low voltage power supplies, d.c. output Part 3: Electromagnetic compatibility (EMC) | | IEC/EN61204-3:2018, Class B |
| Electromagnetic compatibility of multimedia equipment - Emission requirements | without external filter | EN55032:2015, Class B |
| Electromagnetic compatibility of household appliances, electric tools and similar apparatus - Emission Requirements | | EN55014-1:2006 + A2:2011 |
| Information technology equipment - Immunity characters - Limits and methods of measurement | | EN55024:2010 + A1:2015 |
| Electromagnetic compatibility of household appliances, electric tools and similar apparatus - Immunity Requirements | | EN55014-2:2015 |
| ESD Electrostatic discharge immunity test | Air ±8kV, Contact ±4kV | EN61000-4-2:2009, Criteria B |
| Radiated, radio-frequency, electromagnetic field immunity test | 80MHz - 6GHz: 10V/m 1.4GHz - 2GHz: 3V/m 2.0GHz - 2.7GHz: 1V/m | EN61000-4-3:2006 + A1:2008, Criteria A |
| Fast Transient and Burst Immunity | AC Port: ±2.0kV DC Port: ±2.0kV | EN61000-4-4:2012, Criteria B |

continued on next page

Specifications (measured @ Ta= 25°C, nom. Vin, full load and after warm-up unless otherwise stated)

| EMC Compliance | Condition | Standard / Criterion |
|---|--|---|
| Surge Immunity | AC Port: L-N ±1.0kV DC Port: ±0.5kV | EN61000-4-5:2014 + A1:2017, Criteria B |
| Immunity to conducted disturbances, induced by radio-frequency fields | AC Port: 10V DC Port: 10V | EN61000-4-6:2014, Criteria A |
| Power Magnetic Field Immunity | 50Hz, 30A/m | EN61000-4-8:2010, Criteria A |
| Voltage Dips and Interruptions | Voltage Dips 20% Voltage Dips 30% Voltage Dips 60% Voltage Dips 100% Voltage Interruptions > 95% | EN61000-4-11:2004 + A1:2017, Criteria C EN61000-4-11:2004 + A1:2017, Criteria C EN61000-4-11:2004 + A1:2017, Criteria C EN61000-4-11:2004 + A1:2017, Criteria B EN61000-4-11:2004 + A1:2017, Criteria C |
| Limits of Voltage Fluctuations & Flicker | | EN61000-3-3:2013 |
| Limitations on the amount of electromagnetic interference allowed from digital and electronic devices | | FCC 47 CFR Part 15 Subpart B, Class B |
| American National Standard for Methods of Measurement of Radio-Noise Emissions from Low-Voltage Electrical and Electronic Equipment in the Range of 9 kHz to 40 GHz | | ANSI C63.4-2014, Class B |
| Notes: Note9: If output is connected to GND, please contact RECOM tech support for advice | | |

DIMENSION AND PHYSICAL CHARACTERISTICS

| Parameter | Type | Value |
|-------------------|-------------------------------------|---|
| Material | case potting PCB baseplate | black plastic, (UL94V-0) silicone, (UL94V-0) FR4, (UL94V-0) black plastic, (UL94V-0) |
| Dimension (LxWxH) | | 52.5 x 27.4 x 23.0mm |
| Weight | pin wired | 60g typ. 65g typ. |

Dimension Drawing (mm)

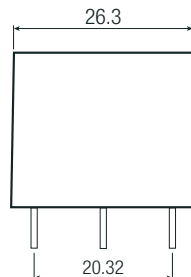
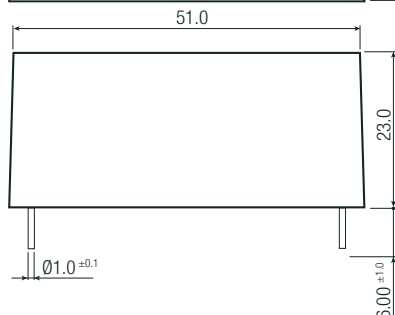
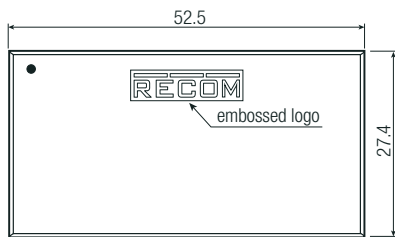
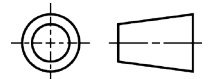

Pinning information

| Pin # | Single | Dual |
|-------|------------|------------|
| 1 | VAC in (N) | VAC in (N) |
| 2 | VAC in (L) | VAC in (L) |
| 3 | no pin | -Vout |
| 4 | -Vout | Com |
| 5 | +Vout | +Vout |

Tolerance: xx.x= ±0.5mm
xx.xx= ±0.25mm

Recommended Footprint Details

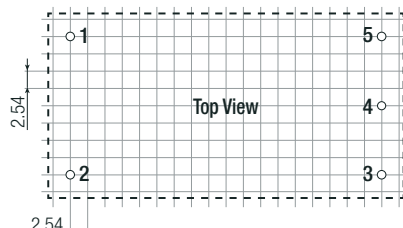
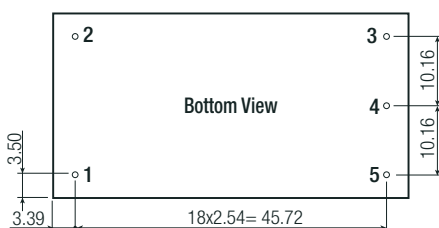

continued on next page

Specifications (measured @ Ta= 25°C, nom. Vin, full load and after warm-up unless otherwise stated)

Dimension Drawing Single Wired (mm)

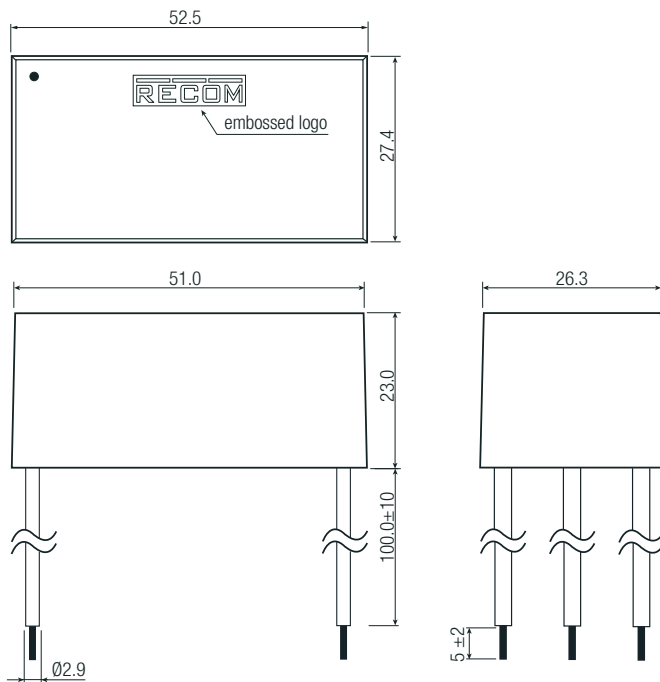
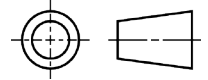

Wired information

| # | Function | Wire color | Type | AWG |
|---|------------|------------|---------|-----|
| 1 | VAC in (N) | blue | UL-1015 | 18 |
| 2 | VAC in (L) | brown | UL-1015 | 18 |
| 4 | -Vout | black | UL-1015 | 18 |
| 5 | +Vout | red | UL-1015 | 18 |

Tolerance: xx.x= ±0.5mm
xx.xx= ±0.25mm

PACKAGING INFORMATION

| Parameter | Type | | Value |
|-----------------------------|-----------|----------------|------------------------|
| | pin wired | tube tray | |
| Packaging Dimension (LxWxH) | | | 490.0 x 56.0 x 40.0mm |
| | | | 488.0 x 202.0 x 47.0mm |
| Packaging Quantity | | tube tray | 15pcs |
| | | tray | 20pcs |
| Storage Temperature Range | | | -40°C to +85°C |
| Storage Humidity | | non-condensing | 20% to 90% RH max. |

The product information and specifications may be subject to changes even without prior written notice. The product has been designed for various applications; its suitability lies in the responsibility of each customer. The products are not authorized for use in safety-critical applications without RECOM's explicit written consent. A safety-critical application is an application where a failure may reasonably be expected to endanger or cause loss of life, inflict bodily harm or damage property. The applicant shall indemnify and hold harmless RECOM, its affiliated companies and its representatives against any damage claims in connection with the unauthorized use of RECOM products in such safety-critical applications.