

Multiband Active GNSS (GPS/GLONASS/BEIDOU) External Antenna



AEARBD048014-SG3



48.5 x 47.0 x 14.0 mm
 RoHS/RoHS II Compliant
 MSL = N/A: Not Applicable

Features

- External Multiband GNSS antenna
- GPS/GLONASS/BEIDOU support
- Active antenna with integrated LNA
- Low VSWR across bands
- SMA connector
- Magnetic mounting

Applications

- GPS/GLONASS applications
- IoT
- M2M
- Surveillance
- Fleet management and asset tracking
- Autonomous driving
- Telematics
- Agriculture
- Instrumentation
- Survey

Electrical Specifications

Parameters	BeiDou	GPS	GLONASS	Units	Notes
Operating Frequency	1561.098 ± 2.046	1575.420 ± 1.023	1602.000 ± 8.000	MHz	
VSWR	2.0				Max.
Peak Gain	5.78	4.27	5.65	dBi	Typ.
Impedance	50			Ω	
Polarization	RHCP				

LNA

Parameters	BeiDou	GPS	GLONASS	Units	Notes
Operating Frequency	1561.098 ± 2.046	1575.420 ± 1.023	1602.000 ± 8.000	MHz	
VSWR	2.0				Max.
Gain	28			dB	Typ.
Noise Figure	1.5			dB	Typ. @ 25°C
	1.8				Max. @ 85°C
Impedance	50			Ω	
Input Voltage (DC)	1.8			V	Min.
	3.0				Typ.
	5.5				Max.

Multiband Active GNSS (GPS/GLONASS/BEIDOU) External Antenna



AEARBD048014-SG3



48.5 x 47.0 x 14.0 mm
RoHS/RoHS II Compliant
MSL = N/A: Not Applicable

System Set-up

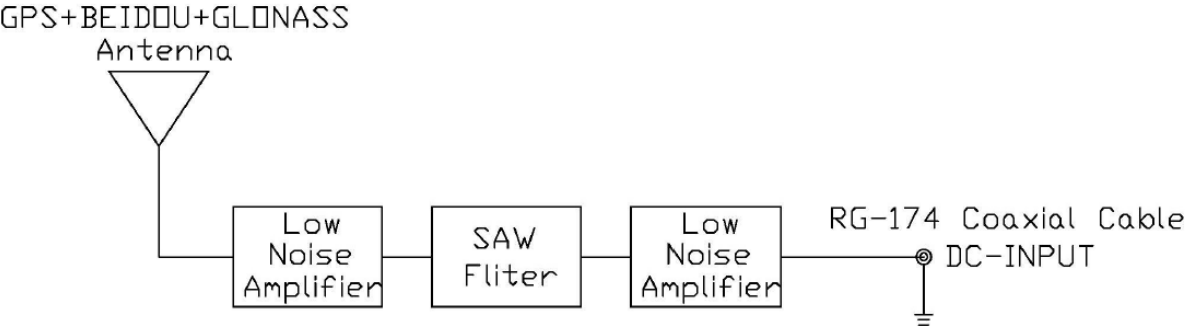

Parameters	BeiDou	GPS	GLONASS	Units	Notes
Operating Frequency	1561.098 ± 2.046	1575.420 ± 1.023	1602.000 ± 8.000	MHz	
VSWR	2.0				Max.
Gain	28			dBic	@Zenith - Cable Loss (@ 3.0 V DC input)
Input Voltage (DC)	1.8			V	Min.
	3.0				Typ.
	5.5				Max.
Impedance	50			Ω	
Cable Loss	-1.4			dB/m	Max.

Mechanical Specification

Parameters	Description	Notes
RF Cable	Ø2.7 ± 0.2 mm	Color : Black
Cable Length (L)	5 ± 0.05 m	
RF Connector	SMA - M	
Mounting Type	Magnet	

Environmental Specification

Parameters	Description
Operating Temperature	-40°C to +85°C
Storage Temperature	-40°C to +105°C
Relative Humidity	40% to 95%

Multiband Active GNSS (GPS/GLONASS/BEIDOU) External Antenna



AEARBD048014-SG3



48.5 x 47.0 x 14.0 mm
RoHS/RoHS II Compliant
MSL = N/A: Not Applicable

Product Dimensions

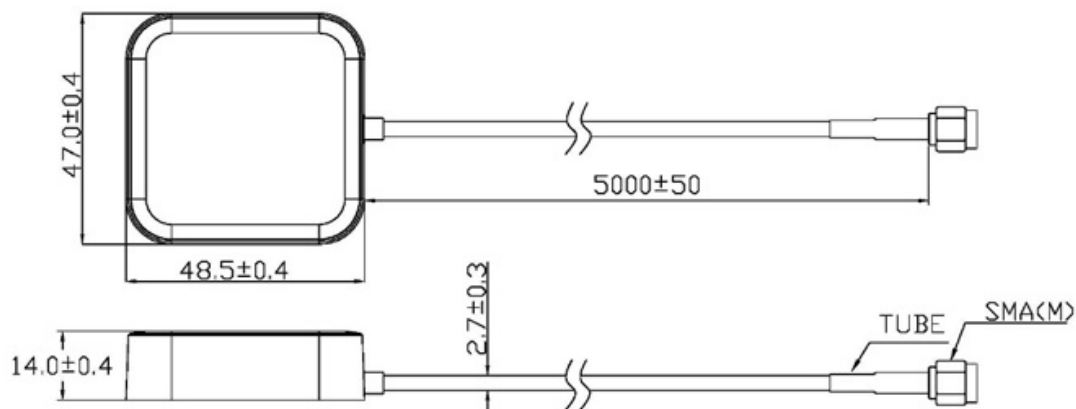

Unit : mm



AEARBD048014-SG3



48.5 x 47.0 x 14.0 mm
RoHS/RoHS II Compliant
MSL = N/A: Not Applicable

Return Loss and Impedance Characteristics

Frequency (MHz)	Return Loss (dB)	Impedance (Ω)	VSWR
1561	-36.58	52.73 - j02.00	1.06
1575	-18.77	44.64 + j06.58	1.24
1602	-16.98	43.96 - j38.40	1.25

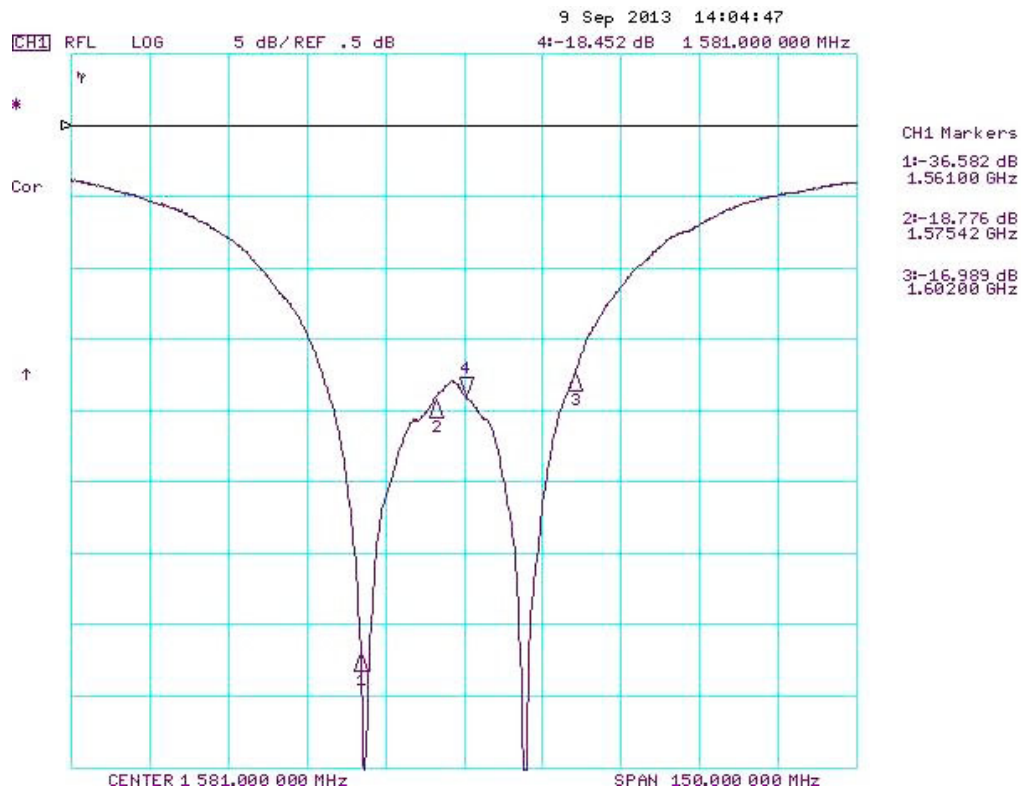



AEARBD048014-SG3



48.5 x 47.0 x 14.0 mm
RoHS/RoHS II Compliant
MSL = N/A: Not Applicable

Return Loss and Impedance Characteristics

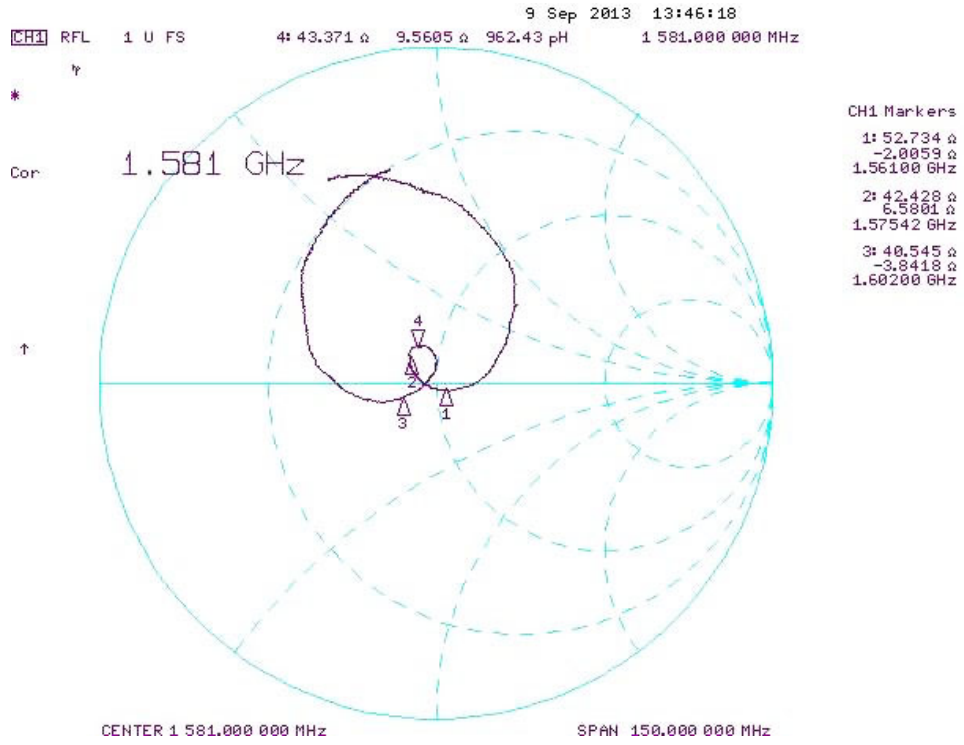

Multiband Active GNSS (GPS/GLONASS/BEIDOU) External Antenna



AEARBD048014-SG3



48.5 x 47.0 x 14.0 mm
RoHS/RoHS II Compliant
MSL = N/A: Not Applicable

Radiation Pattern

XZ - Plane

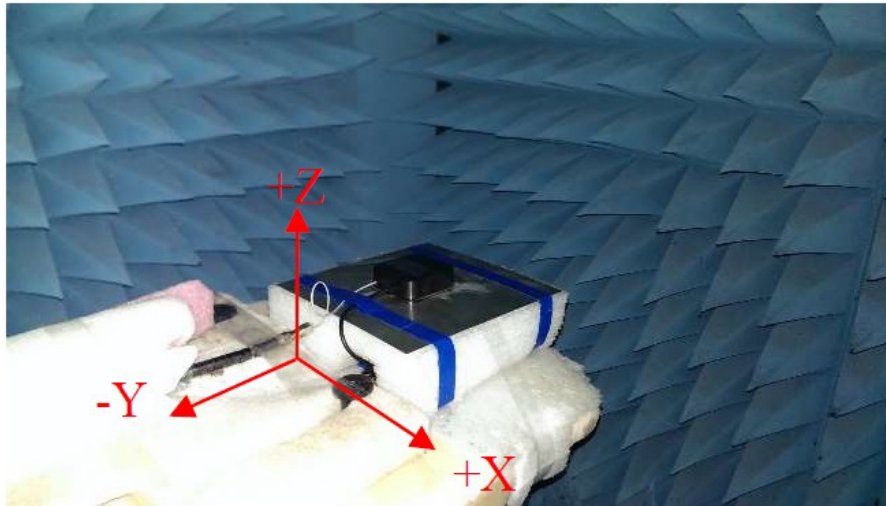

YZ - Plane

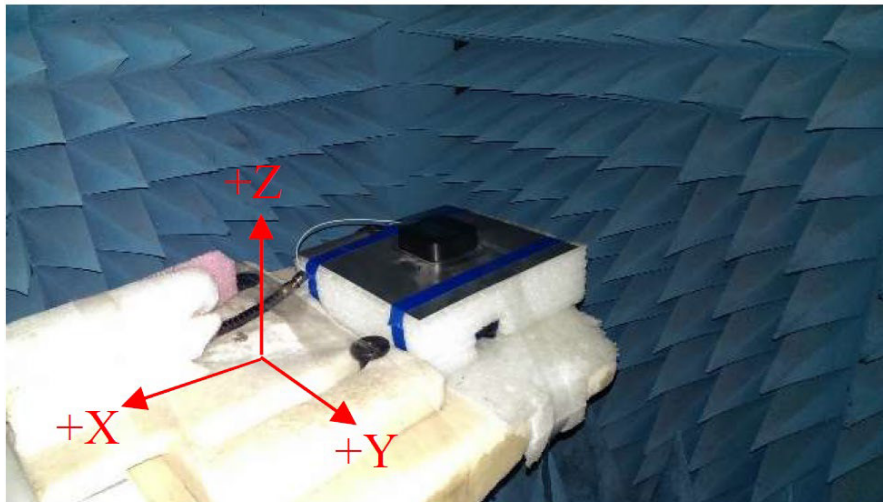

Multiband Active GNSS (GPS/GLONASS/BEIDOU) External Antenna



AEARBD048014-SG3



48.5 x 47.0 x 14.0 mm
 RoHS/RoHS II Compliant
 MSL = N/A: Not Applicable

Radiation Pattern

BeiDou : 1561 MHz

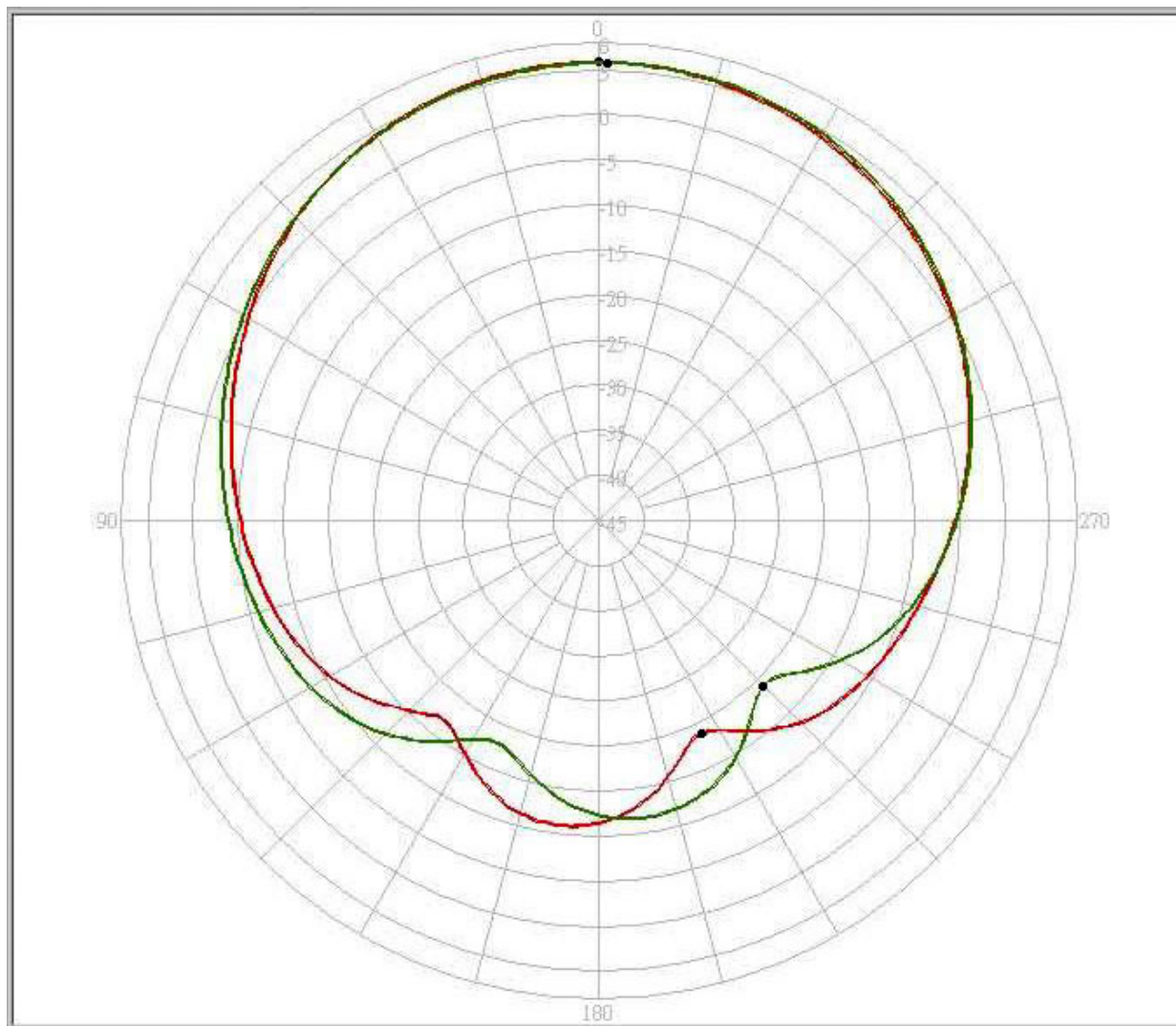

1561 MHz	Peak Gain (dBi)	Zenith Gain (dBi)
XZ	5.81	5.81
YZ	5.78	5.78

Multiband Active GNSS (GPS/GLONASS/BEIDOU) External Antenna



AEARBD048014-SG3



48.5 x 47.0 x 14.0 mm
 RoHS/RoHS II Compliant
 MSL = N/A: Not Applicable

Radiation Pattern

GPS : 1575.42 MHz

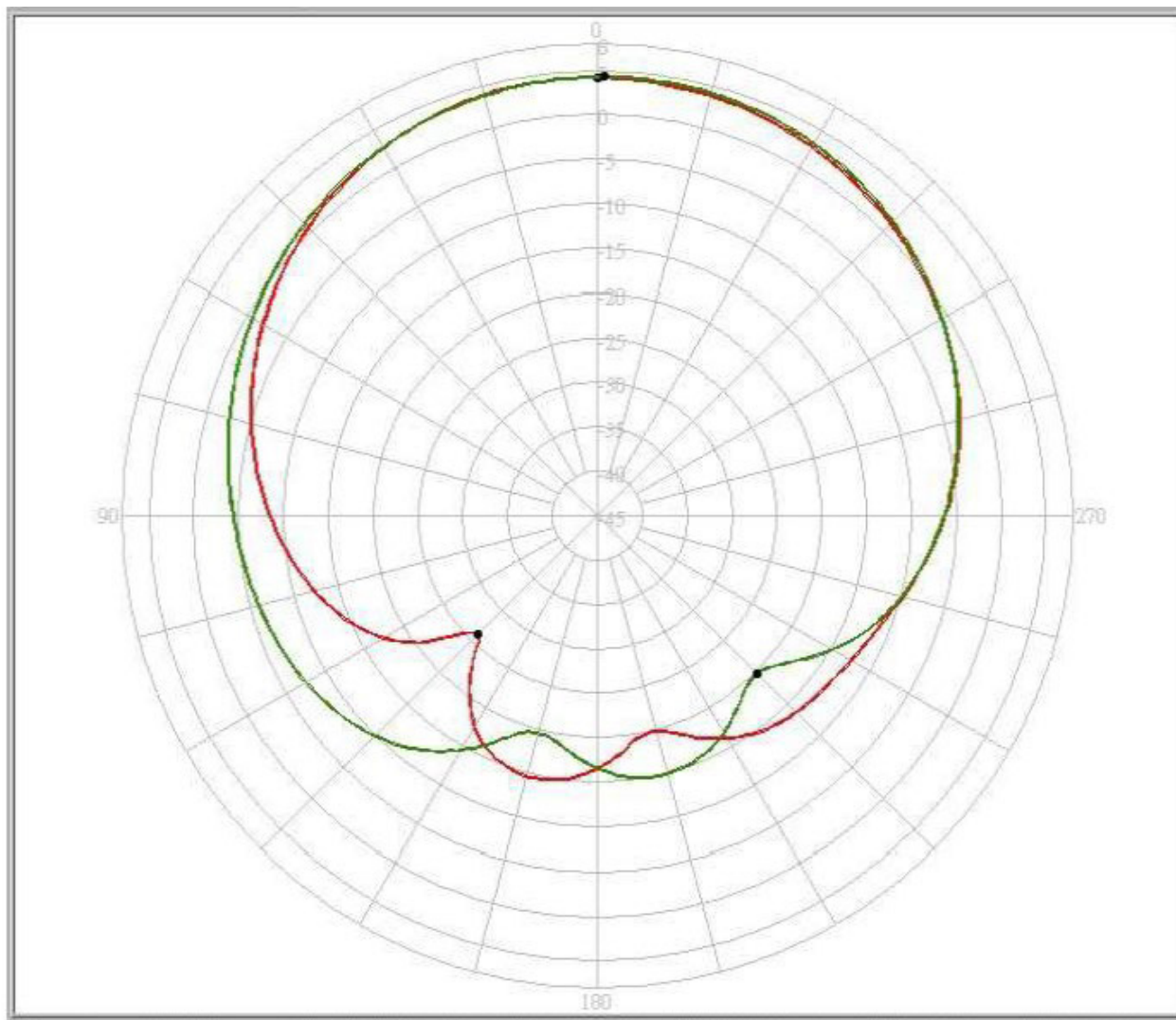

1561 MHz	Peak Gain (dBi)	Zenith Gain (dBi)
XZ	4.18	4.18
YZ	4.27	4.18

Multiband Active GNSS (GPS/GLONASS/BEIDOU) External Antenna



AEARBD048014-SG3



48.5 x 47.0 x 14.0 mm
 RoHS/RoHS II Compliant
 MSL = N/A: Not Applicable

Radiation Pattern

GLONASS : 1602 MHz

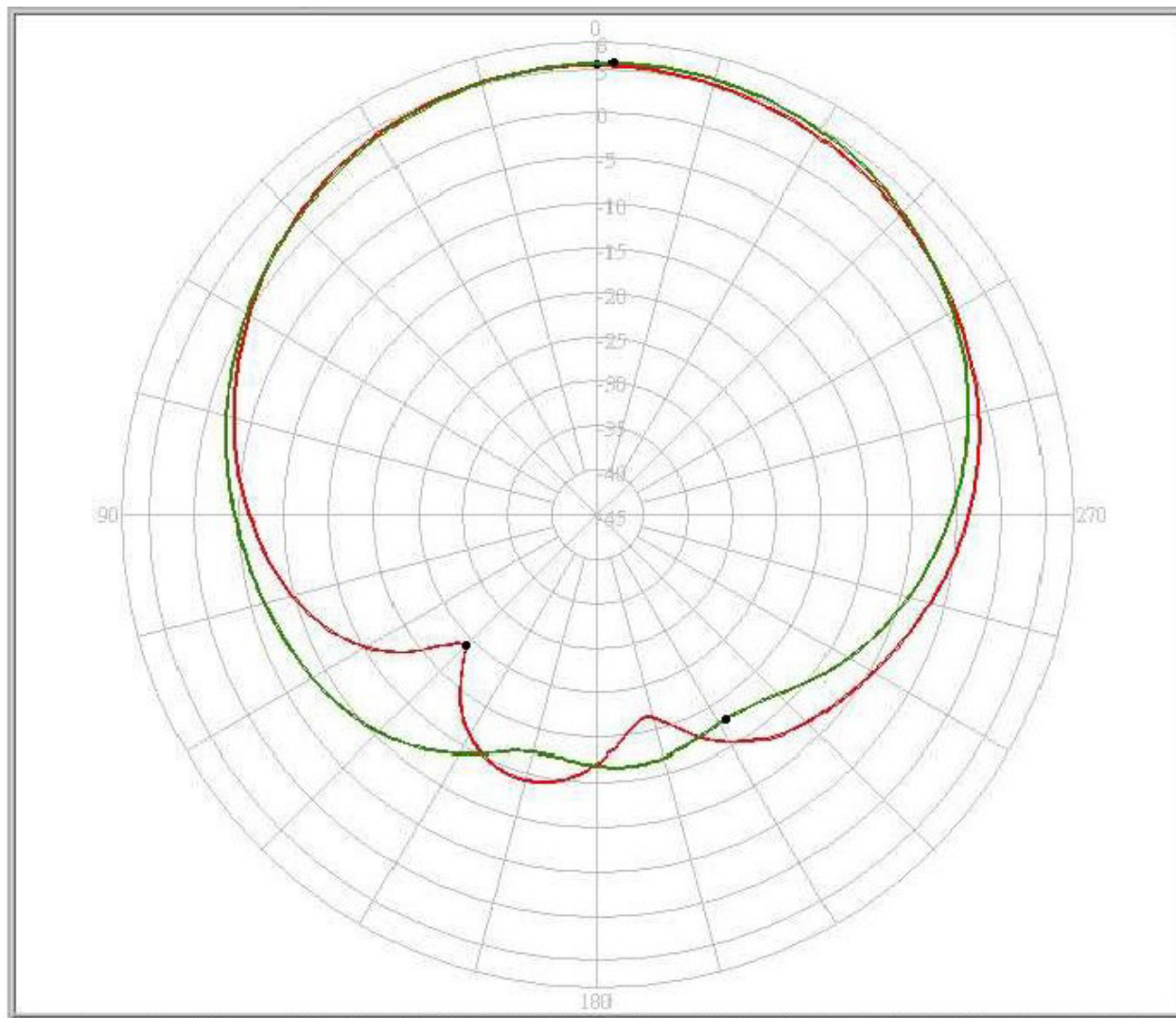

1561 MHz	Peak Gain (dBi)	Zenith Gain (dBi)
XZ	5.40	5.40
YZ	5.65	5.40



AEARBD048014-SG3



48.5 x 47.0 x 14.0 mm
RoHS/RoHS II Compliant
MSL = N/A: Not Applicable

Radiation Pattern - 3D Pattern

BeiDou : 1561 MHz

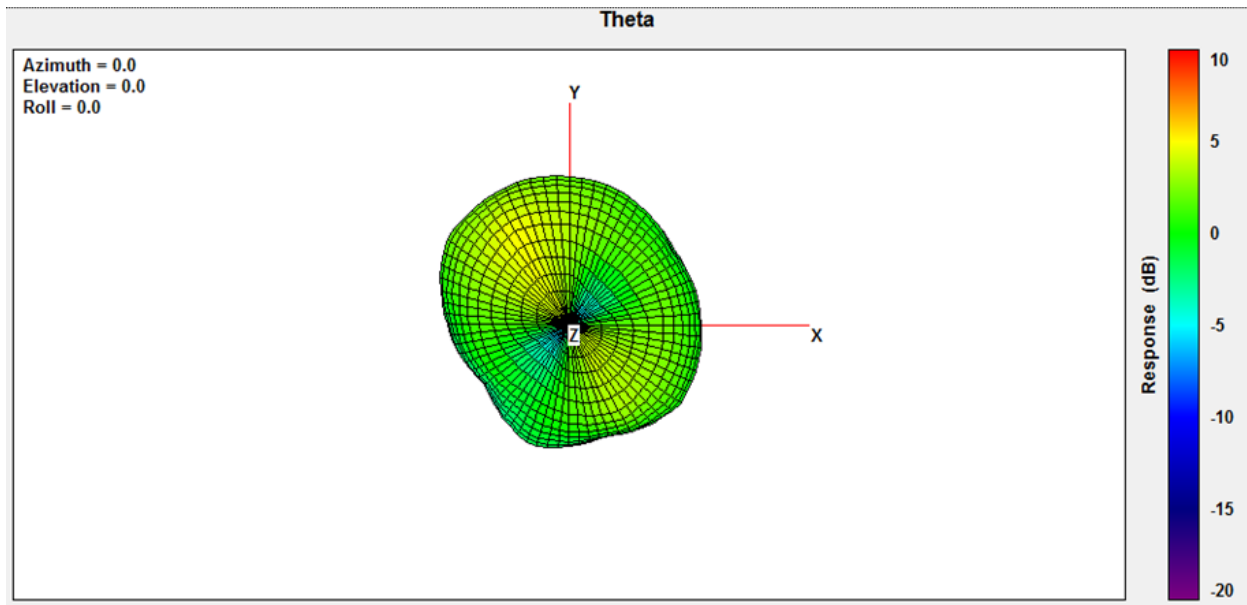

GPS : 1575.42 MHz

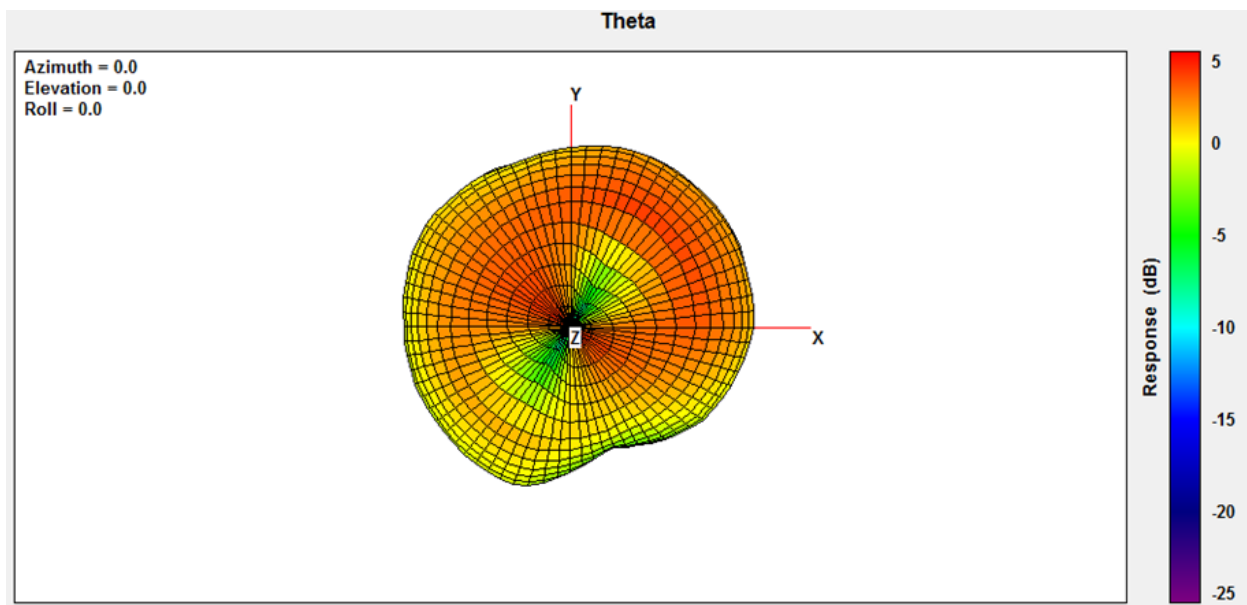



AEARBD048014-SG3



48.5 x 47.0 x 14.0 mm
RoHS/RoHS II Compliant
MSL = N/A: Not Applicable

Radiation Pattern - 3D Pattern

GLONASS : 1602 MHz

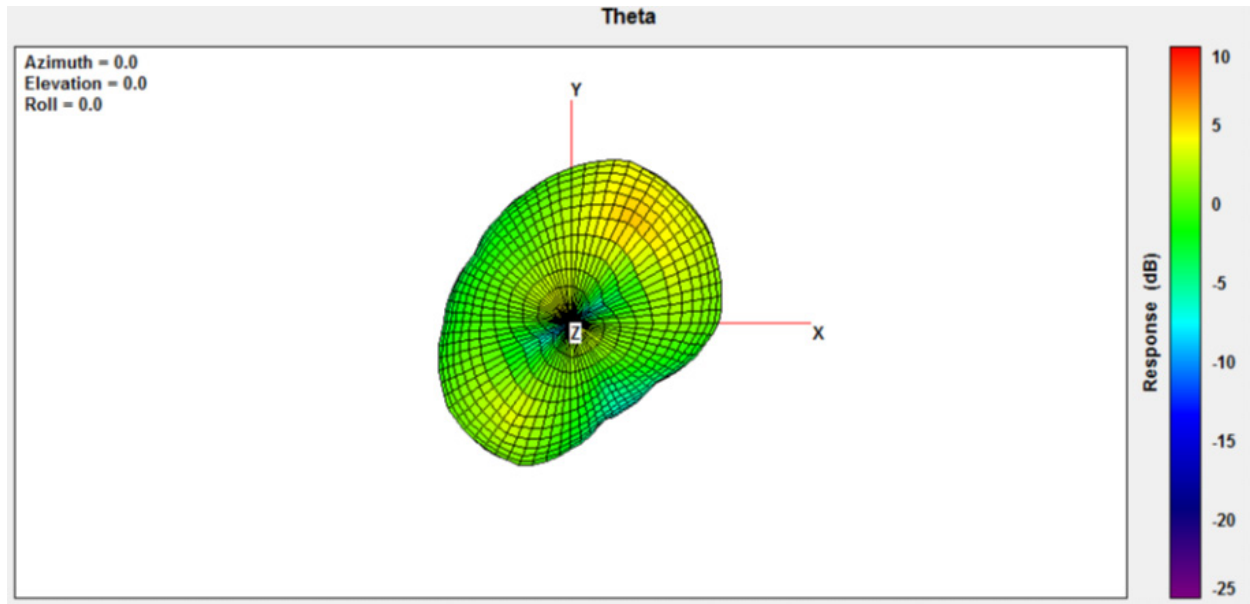

Packaging

Each carton is of dimension 370 x 370 x 300 mm with 100 units.