

### FEATURES

- Laser trimmed to high accuracy**
- 5.000 V  $\pm$ 2.0 mV (M grade)**
- Trimmed temperature coefficient**
  - 2 ppm/ $^{\circ}$ C max, 0 $^{\circ}$ C to 70 $^{\circ}$ C (M grade)**
  - 5 ppm/ $^{\circ}$ C max, -40 $^{\circ}$ C to +85 $^{\circ}$ C (B and L grades)**
  - 10 ppm/ $^{\circ}$ C max, -55 $^{\circ}$ C to +125 $^{\circ}$ C (T grade)**
- Low noise, 100 nV/ $\sqrt{\text{Hz}}$**
- Noise reduction capability**
- Output trim capability**
- MIL-STD-883-compliant versions available**
- Industrial temperature range SOICs available**
- Output capable of sourcing or sinking 10 mA**

### GENERAL DESCRIPTION

The AD586 represents a major advance in state-of-the-art monolithic voltage references. Using a proprietary ion-implanted buried Zener diode and laser wafer trimming of high stability thin-film resistors, the AD586 provides outstanding performance at low cost.

The AD586 offers much higher performance than most other 5 V references. Because the AD586 uses an industry-standard pinout, many systems can be upgraded instantly with the AD586.

The buried Zener approach to reference design provides lower noise and drift than band gap voltage references. The AD586 offers a noise reduction pin that can be used to further reduce the noise level generated by the buried Zener.

The AD586 is recommended for use as a reference for 8-, 10-, 12-, 14-, or 16-bit DACs that require an external precision reference. The device is also ideal for successive approximation or integrating ADCs with up to 14 bits of accuracy and, in general, can offer better performance than the standard on-chip references.

The AD586J, AD586K, AD586L, and AD586M are specified for operation from 0 $^{\circ}$ C to 70 $^{\circ}$ C; the AD586A and AD586B are specified for -40 $^{\circ}$ C to +85 $^{\circ}$ C operation; and the AD586S and AD586T are specified for -55 $^{\circ}$ C to +125 $^{\circ}$ C operation.

#### Rev. G

Information furnished by Analog Devices is believed to be accurate and reliable. However, no responsibility is assumed by Analog Devices for its use, nor for any infringements of patents or other rights of third parties that may result from its use. Specifications subject to change without notice. No license is granted by implication or otherwise under any patent or patent rights of Analog Devices. Trademarks and registered trademarks are the property of their respective owners.

The AD586J, AD586K, AD586L, and AD586M are available in an 8-lead PDIP; the AD586J, AD586K, AD586L, AD586A, and AD586B are available in an 8-lead SOIC package; and the AD586J, AD586K, AD586L, AD586S, and AD586T are available in an 8-lead CERDIP package.

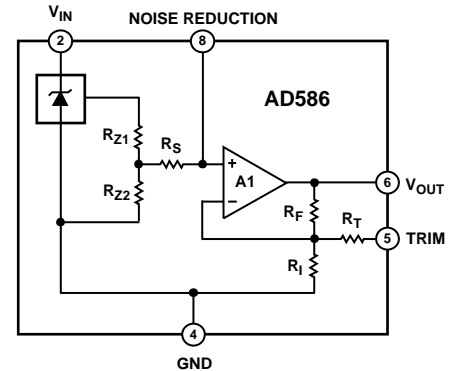

**NOTES**  
1. PINS 1, 3, AND 7 ARE INTERNAL TEST POINTS.  
MAKE NO CONNECTIONS TO THESE POINTS.

00528-010

Figure 1.

### PRODUCT HIGHLIGHTS

1. Laser trimming of both initial accuracy and temperature coefficients results in very low errors over temperature without the use of external components. The AD586M has a maximum deviation from 5.000 V of  $\pm$ 2.45 mV between 0 $^{\circ}$ C and 70 $^{\circ}$ C, and the AD586T guarantees  $\pm$ 7.5 mV maximum total error between -55 $^{\circ}$ C and +125 $^{\circ}$ C.
2. For applications requiring higher precision, an optional fine-trim connection is provided.
3. Any system using an industry-standard pinout reference can be upgraded instantly with the AD586.
4. Output noise of the AD586 is very low, typically 4  $\mu$ V p-p. A noise reduction pin is provided for additional noise filtering using an external capacitor.
5. The AD586 is available in versions compliant with MIL-STD-883. Refer to the Analog Devices Military Products Databook or the current AD586/883B data sheet for detailed specifications.

## TABLE OF CONTENTS

Specifications.....	3	Load Regulation .....	9
AD586J, AD586K/AD586A, AD586L/AD586B .....	3	Temperature Performance.....	9
AD586M, AD586S, AD586T .....	4	Negative Reference Voltage from an AD586.....	10
Absolute Maximum Ratings.....	5	Using the AD586 with Converters .....	10
ESD Caution.....	5	5 V Reference with Multiplying CMOS DACs or ADCs .....	11
Pin Configurations and Function Descriptions .....	6	Stacked Precision References for Multiple Voltages .....	11
Theory of Operation .....	7	Precision Current Source .....	11
Applying the AD586.....	7	Precision High Current Supply .....	11
Noise Performance and Reduction .....	7	Outline Dimensions .....	13
Turn-on Time.....	8	Ordering Guide .....	14
Dynamic Performance.....	8		

## REVISION HISTORY

### 3/05—Rev. F to Rev. G

Updated Format.....	Universal
Split Specifications Table into Table 1 and Table 2.....	3
Changes to Table 1.....	3
Added Figure 2 and Figure 4.....	6
Updated Outline Dimensions .....	13
Changes to Ordering Guide .....	14

### 1/04—Rev. E to Rev. F

Changes to ORDERING GUIDE .....	3
---------------------------------	---

### 7/03—Rev. D to Rev. E

Removed AD586J CHIPS .....	Universal
Updated ORDERING GUIDE.....	3
Change to Figure 3 .....	4
Updated Figure 12 .....	7
Updated OUTLINE DIMENSIONS .....	9

### 4/01—Rev. C to Rev. D

Changed Figure 10 to Table 1 (Maximum Output Change in mV).....	6
--	---

### 11/95—Revision 0: Initial Version

## SPECIFICATIONS

### AD586J, AD586K/AD586A, AD586L/AD586B

@  $T_A = 25^\circ\text{C}$ ,  $V_{IN} = 15\text{ V}$ , unless otherwise noted. Specifications in **boldface** are tested on all production units at final electrical test. Results from those tests are used to calculate outgoing quality levels. All minimum and maximum specifications are guaranteed, although only those shown in **boldface** are tested on all production units, unless otherwise specified.

Table 1.

Parameter	AD586J			AD586K/AD586A			AD586L/AD586B			Unit
	Min	Typ	Max	Min	Typ	Max	Min	Typ	Max	
OUTPUT VOLTAGE	4.980		5.020	4.995		5.005	4.9975		5.0025	V
OUTPUT VOLTAGE DRIFT <sup>1</sup>										
$0^\circ\text{C}$ to $70^\circ\text{C}$			25			15			5	ppm/ $^\circ\text{C}$
$-55^\circ\text{C}$ to $+125^\circ\text{C}$										ppm/ $^\circ\text{C}$
GAIN ADJUSTMENT	<b>+6</b>			<b>+6</b>			<b>+6</b>			%
	<b>-2</b>			<b>-2</b>			<b>-2</b>			%
LINE REGULATION <sup>1</sup>										
$10.8\text{ V} < +V_{IN} < 36\text{ V}$										
$T_{MIN}$ to $T_{MAX}$			<b><math>\pm 100</math></b>			<b><math>\pm 100</math></b>			<b><math>\pm 100</math></b>	$\mu\text{V/V}$
$11.4\text{ V} < +V_{IN} < 36\text{ V}$										
$T_{MIN}$ to $T_{MAX}$										$\mu\text{V/V}$
LOAD REGULATION <sup>1</sup>										
Sourcing $0\text{ mA} < I_{OUT} < 10\text{ mA}$										
$25^\circ\text{C}$			<b>100</b>			<b>100</b>			<b>100</b>	$\mu\text{V/mA}$
$T_{MIN}$ to $T_{MAX}$			<b>100</b>			<b>100</b>			<b>100</b>	$\mu\text{V/mA}$
Sinking $-10\text{ mA} < I_{OUT} < 0\text{ mA}$										
$25^\circ\text{C}$			<b>400</b>			<b>400</b>			<b>400</b>	$\mu\text{V/mA}$
QUIESCENT CURRENT	2		<b>3</b>	2		<b>3</b>	2		<b>3</b>	mA
POWER CONSUMPTION	30			30			30			mW
OUTPUT NOISE										
$0.1\text{ Hz}$ to $10\text{ Hz}$		4			4			4		$\mu\text{V p-p}$
Spectral Density, $100\text{ Hz}$		100			100			100		$\text{nV}/\sqrt{\text{Hz}}$
LONG-TERM STABILITY		15			15			15		ppm/1000 hr
SHORT-CIRCUIT CURRENT-TO-GROUND		45	<b>60</b>		45	<b>60</b>		45	<b>60</b>	mA
TEMPERATURE RANGE										
Specified Performance <sup>2</sup>	0		70	0 (K grade)		70	0 (L grade)		70	$^\circ\text{C}$
				-40 (A grade)		+85	-40 (B grade)		+85	$^\circ\text{C}$
Operating Performance <sup>3</sup>	-40		+85	-40		+85	-40		+85	$^\circ\text{C}$

<sup>1</sup> Maximum output voltage drift is guaranteed for all packages and grades. CERDIP packaged parts are also  $100^\circ\text{C}$  production tested.

<sup>2</sup> Lower row shows specified performance for A and B grades.

<sup>3</sup> The operating temperature range is defined as the temperature extremes at which the device will still function. Parts may deviate from their specified performance outside their specified temperature range.

# AD586

## AD586M, AD586S, AD586T

@  $T_A = 25^\circ\text{C}$ ,  $V_{IN} = 15\text{ V}$ , unless otherwise noted. Specifications in **boldface** are tested on all production units at final electrical test. Results from those tests are used to calculate outgoing quality levels. All minimum and maximum specifications are guaranteed, although only those shown in **boldface** are tested on all production units, unless otherwise specified.

**Table 2.**

Parameter	AD586M			AD586S			AD586T			Unit
	Min	Typ	Max	Min	Typ	Max	Min	Typ	Max	
OUTPUT VOLTAGE	4.998		5.002	4.990		5.010	4.9975		5.0025	V
OUTPUT VOLTAGE DRIFT <sup>1</sup>										
0°C to 70°C			2							ppm/°C
-55°C to +125°C						20			10	ppm/°C
GAIN ADJUSTMENT	<b>+6</b>			<b>+6</b>			<b>+6</b>			%
	-2			-2			-2			%
LINE REGULATION <sup>1</sup>										
10.8 V < $V_{IN}$ < 36 V										
$T_{MIN}$ to $T_{MAX}$			<b>±100</b>							μV/V
11.4 V < $V_{IN}$ < 36 V										
$T_{MIN}$ to $T_{MAX}$						<b>±150</b>			<b>±150</b>	μV/V
LOAD REGULATION <sup>1</sup>										
Sourcing 0 mA < $I_{OUT}$ < 10 mA										
25°C			<b>100</b>			<b>150</b>			<b>150</b>	μV/mA
$T_{MIN}$ to $T_{MAX}$			<b>100</b>			<b>150</b>			<b>150</b>	μV/mA
Sinking -10 mA < $I_{OUT}$ < 0 mA										
25°C			<b>400</b>			<b>400</b>			<b>400</b>	μV/mA
QUIESCENT CURRENT	2	<b>3</b>		2	<b>3</b>		2	<b>3</b>		mA
POWER CONSUMPTION	30			30			30			mW
OUTPUT NOISE										
0.1 Hz to 10 Hz		4			4			4		μV p-p
Spectral Density, 100 Hz		100			100			100		nV/√Hz
LONG-TERM STABILITY		15			15			15		ppm/1000 hr
SHORT-CIRCUIT CURRENT-TO-GROUND		45	<b>60</b>		45	<b>60</b>		45	<b>60</b>	mA
TEMPERATURE RANGE										
Specified Performance <sup>2</sup>	0		70	-55		+125	-55		+125	°C
Operating Performance <sup>3</sup>	-40		+85	-55		+125	-55		+125	°C

<sup>1</sup> Maximum output voltage drift is guaranteed for all packages and grades. CERDIP packaged parts are also 100°C production tested.

<sup>2</sup> Lower row shows specified performance for A and B grades.

<sup>3</sup> The operating temperature range is defined as the temperature extremes at which the device will still function. Parts may deviate from their specified performance outside their specified temperature range.

## ABSOLUTE MAXIMUM RATINGS

Table 3.

Parameter	Rating
$V_{IN}$ to Ground	36 V
Power Dissipation (25°C)	500 mW
Storage Temperature	-65°C to +150°C
Lead Temperature (Soldering, 10 sec)	300°C
Package Thermal Resistance	
$\theta_{JC}$	22°C/W
$\theta_{JA}$	110°C/W
Output Protection	Output safe for indefinite short to ground or $V_{IN}$ .

Stresses above those listed under Absolute Maximum Ratings may cause permanent damage to the device. This is a stress rating only; functional operation of the device at these or any other conditions above those indicated in the operational section of this specification is not implied. Exposure to absolute maximum rating conditions for extended periods may affect device reliability.

### ESD CAUTION

ESD (electrostatic discharge) sensitive device. Electrostatic charges as high as 4000 V readily accumulate on the human body and test equipment and can discharge without detection. Although this product features proprietary ESD protection circuitry, permanent damage may occur on devices subjected to high energy electrostatic discharges. Therefore, proper ESD precautions are recommended to avoid performance degradation or loss of functionality.



## PIN CONFIGURATIONS AND FUNCTION DESCRIPTIONS



<sup>1</sup>TP DENOTES FACTORY TEST POINT. NO CONNECTIONS, EXCEPT DUMMY PCB PAD, SHOULD BE MADE TO THESE POINTS.

005229-002

Figure 2. Pin Configuration (N-8)



<sup>1</sup>TP DENOTES FACTORY TEST POINT. NO CONNECTIONS, EXCEPT DUMMY PCB PAD, SHOULD BE MADE TO THESE POINTS.

005229-003

Figure 3. Pin Configuration (Q-8)



<sup>1</sup>TP DENOTES FACTORY TEST POINT. NO CONNECTIONS, EXCEPT DUMMY PCB PAD, SHOULD BE MADE TO THESE POINTS.

005229-004

Figure 4. Pin Configuration (R-8)

Table 4. Pin Function Descriptions

Pin No.	Mnemonic	Description
1	TP <sup>1</sup>	Factory Trim Pad (No Connect).
2	V <sub>IN</sub>	Input Voltage.
3	TP <sup>1</sup>	Factory Trim Pad (No Connect).
4	GND	Ground.
5	TRIM	Optional External Fine Trim. See the Applying the AD586 section.
6	V <sub>OUT</sub>	Output Voltage.
7	TP <sup>1</sup>	Factory Trim Pad (No Connect).
8	NOISE REDUCTION	Optional Noise Reduction Filter with External 1 μF Capacitor to Ground.

## THEORY OF OPERATION

The AD586 consists of a proprietary buried Zener diode reference, an amplifier to buffer the output, and several high stability thin-film resistors, as shown in the block diagram in Figure 5. This design results in a high precision monolithic 5 V output reference with initial offset of 2.0 mV or less. The temperature compensation circuitry provides the device with a temperature coefficient of under 2 ppm/°C.

Using the bias compensation resistor between the Zener output and the noninverting input to the amplifier, a capacitor can be added at the noise reduction pin (Pin 8) to form a low-pass filter and reduce the noise contribution of the Zener to the circuit.

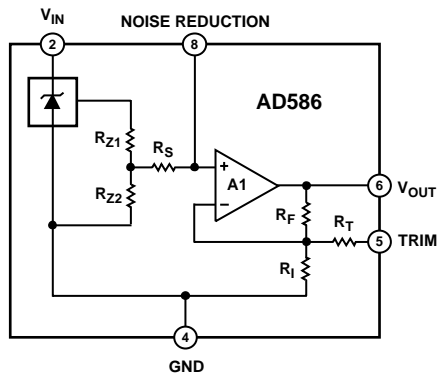

**NOTES**  
1. PINS 1, 3, AND 7 ARE INTERNAL TEST POINTS. MAKE NO CONNECTIONS TO THESE POINTS.

Figure 5. Functional Block Diagram

## APPLYING THE AD586

The AD586 is simple to use in virtually all precision reference applications. When power is applied to Pin 2 and Pin 4 is grounded, Pin 6 provides a 5 V output. No external components are required; the degree of desired absolute accuracy is achieved simply by selecting the required device grade. The AD586 requires less than 3 mA quiescent current from an operating supply of 12 V or 15 V.

An external fine trim may be desired to set the output level to exactly 5.000 V (calibrated to a main system reference). System calibration may also require a reference voltage that is slightly different from 5.000 V, for example, 5.12 V for binary applications. In either case, the optional trim circuit shown in Figure 6 can offset the output by as much as 300 mV with minimal effect on other device characteristics.

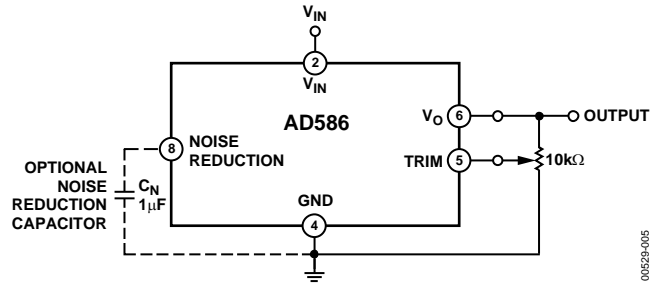

Figure 6. Optional Fine-Trim Configuration

## NOISE PERFORMANCE AND REDUCTION

The noise generated by the AD586 is typically less than 4 μV p-p over the 0.1 Hz to 10 Hz band. Noise in a 1 MHz bandwidth is approximately 200 μV p-p. The dominant source of this noise is the buried Zener, which contributes approximately 100 nV/√Hz. By comparison, contribution by the op amp is negligible. Figure 7 shows the 0.1 Hz to 10 Hz noise of a typical AD586. The noise measurement is made with a band-pass filter made of a 1-pole high-pass filter with a corner frequency at 0.1 Hz, and a 2-pole low-pass filter with a corner frequency at 12.6 Hz, to create a filter with a 9.922 Hz bandwidth.

If further noise reduction is desired, an external capacitor can be added between the noise reduction pin and ground, as shown in Figure 6. This capacitor, combined with the 4 kΩ RS and the Zener resistances, forms a low-pass filter on the output of the Zener cell. A 1 μF capacitor will have a 3 dB point at 12 Hz, and will reduce the high frequency (to 1 MHz) noise to about 160 μV p-p. Figure 8 shows the 1 MHz noise of a typical AD586, both with and without a 1 μF capacitor.

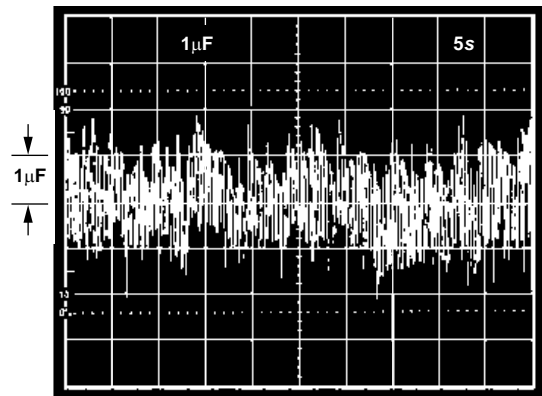

Figure 7. 0.1 Hz to 10 Hz Noise



Figure 8. Effect of 1  $\mu\text{F}$  Noise Reduction Capacitor on Broadband Noise



Figure 10. Extended Time Scale

## TURN-ON TIME

Upon application of power (cold start), the time required for the output voltage to reach its final value within a specified error band is defined as the turn-on settling time. Two components normally associated with this are the time for the active circuits to settle, and the time for the thermal gradients on the chip to stabilize. Figure 9, Figure 10, and Figure 11 show the turn-on characteristics of the AD586. It shows the settling to be about 60  $\mu\text{s}$  to 0.01%. Note the absence of any thermal tails when the horizontal scale is expanded to 1 ms/cm in Figure 10.

Output turn-on time is modified when an external noise reduction capacitor is used. When present, this capacitor acts as an additional load to the current source of the internal Zener diode, resulting in a somewhat longer turn-on time. In the case of a 1  $\mu\text{F}$  capacitor, the initial turn-on time is approximately 400 ms to 0.01% (see Figure 11).



Figure 11. Turn-On with 1  $\mu\text{F}$   $C_N$  Characteristics



Figure 9. Electrical Turn-On

## DYNAMIC PERFORMANCE

The output buffer amplifier is designed to provide the AD586 with static and dynamic load regulation superior to less complete references.

Many ADCs and DACs present transient current loads to the reference, and poor reference response can degrade the performance of the converter.

Figure 12, Figure 13, and Figure 14 display the characteristics of the AD586 output amplifier driving a 0 mA to 10 mA load.



Figure 12. Transient Load Test Circuit





Figure 13. Large-Scale Transient Response



Figure 16. Output Response with Capacitive Load



Figure 14. Fine-Scale Setting for Transient Load

In some applications, a varying load may be both resistive and capacitive in nature, or the load may be connected to the AD586 by a long capacitive cable.

Figure 15 and Figure 16 display the output amplifier characteristics driving a 1000 pF, 0 mA to 10 mA load.



Figure 15. Capacitive Load Transient Response Test Circuit

### LOAD REGULATION

The AD586 has excellent load regulation characteristics. Figure 17 shows that varying the load several mA changes the output by a few  $\mu\text{V}$ . The AD586 has somewhat better load regulation performance sourcing current than sinking current.



Figure 17. Typical Load Regulation Characteristics

### TEMPERATURE PERFORMANCE

The AD586 is designed for precision reference applications where temperature performance is critical. Extensive temperature testing ensures that the device maintains a high level of performance over the operating temperature range.

Some confusion exists with defining and specifying reference voltage error over temperature. Historically, references have been characterized using a maximum deviation per degree Celsius, that is, ppm/ $^{\circ}\text{C}$ . However, because of nonlinearities in temperature characteristics that originated in standard Zener references (such as “S” type characteristics), most manufacturers have begun to use a maximum limit error band approach to specify devices. This technique involves measuring the output at three or more different temperatures to specify an output voltage error band.

# AD586

Figure 18 shows the typical output voltage drift for the AD586L and illustrates the test methodology. The box in Figure 18 is bounded on the sides by the operating temperature extremes and on the top and the bottom by the maximum and minimum output voltages measured over the operating temperature range. The slope of the diagonal drawn from the lower left to the upper right corner of the box determines the performance grade of the device.



Figure 18. Typical AD586L Temperature Drift

Each AD586J, AD586K, and AD586L grade unit is tested at 0°C, 25°C, and 70°C. Each AD586SQ and AD586TQ grade unit is tested at -55°C, +25°C, and +125°C. This approach ensures that the variations of output voltage that occur as the temperature changes within the specified range will be contained within a box whose diagonal has a slope equal to the maximum specified drift. The position of the box on the vertical scale will change from device to device as initial error and the shape of the curve vary. The maximum height of the box for the appropriate temperature range and device grade is shown in Table 5. Duplication of these results requires a combination of high accuracy and stable temperature control in a test system. Evaluation of the AD586 will produce a curve similar to that in Figure 18, but output readings could vary depending on the test methods and equipment used.

Table 5. Maximum Output Change in mV

Device Grade	Maximum Output Change (mV)		
	0°C to 70°C	-40°C to +85°C	-55°C to +125°C
AD586J	8.75		
AD586K	5.25		
AD586L	1.75		
AD586M	0.70		
AD586A		9.37	
AD586B		3.12	
AD586S			18.00
AD586T			9.00

## NEGATIVE REFERENCE VOLTAGE FROM AN AD586

The AD586 can be used to provide a precision -5.000 V output, as shown in Figure 19. The V<sub>IN</sub> pin is tied to at least a 6 V supply, the output pin is grounded, and the AD586 ground pin is connected through a resistor, R<sub>S</sub>, to a -15 V supply. The -5 V output is now taken from the ground pin (Pin 4) instead of V<sub>OUT</sub>. It is essential to arrange the output load and the supply resistor, R<sub>S</sub>, so that the net current through the AD586 is between 2.5 mA and 10.0 mA. The temperature characteristics and long-term stability of the device will be essentially the same as that of a unit used in the standard +5 V output configuration.

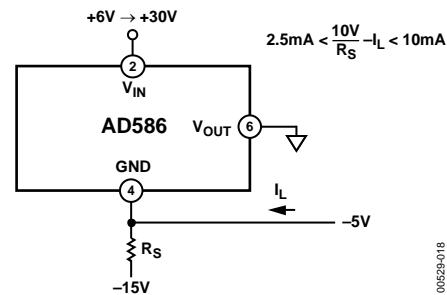

Figure 19. AD586 as a Negative 5 V Reference

## USING THE AD586 WITH CONVERTERS

The AD586 is an ideal reference for a wide variety of 8-, 12-, 14-, and 16-bit ADCs and DACs. Several representative examples are explained in the following sections.

**5 V REFERENCE WITH MULTIPLYING CMOS DACs OR ADCs**

The AD586 is ideal for applications with 10- and 12-bit multiplying CMOS DACs. In the standard hookup, as shown in Figure 20, the AD586 is paired with the AD7545 12-bit multiplying DAC and the AD711 high speed BiFET op amp. The amplifier DAC configuration produces a unipolar 0 V to -5 V output range. Bipolar output applications and other operating details can be found in the individual product data sheets.



Figure 20. Low Power 12-Bit CMOS DAC Application

The AD586 can also be used as a precision reference for multiple DACs. Figure 21 shows the AD586, the AD7628 dual DAC, and the AD712 dual op amp hooked up for single-supply operation to produce 0 V to -5 V outputs. Because both DACs are on the same die and share a common reference and output op amps, the DAC outputs will exhibit similar gain TCs.



Figure 21. AD586 as a 5 V Reference for a CMOS

**STACKED PRECISION REFERENCES FOR MULTIPLE VOLTAGES**

Often, a design requires several reference voltages. Three AD586s can be stacked, as shown in Figure 22, to produce 5.000 V, 10.000 V, and 15.000 V outputs. This scheme can be extended to any number of AD586s, provided the maximum load current is not exceeded. This design provides the additional advantage of improved line regulation on the 5.0 V output. Changes in V\_IN of 18 V to 50 V produce output changes that are below the noise level of the references.



Figure 22. Multiple AD586s Stacked for Precision 5 V, 10 V, and 15 V Outputs

**PRECISION CURRENT SOURCE**

The design of the AD586 allows it to be easily configured as a current source. By choosing the control resistor R\_C in Figure 23, the user can vary the load current from the quiescent current (typically, 2 mA) to approximately 10 mA. The compliance voltage of this circuit varies from about 5 V to 21 V, depending on the value of V\_IN.



Figure 23. Precision Current Source

**PRECISION HIGH CURRENT SUPPLY**

For higher currents, the AD586 can easily be connected to a power PNP or power Darlington PNP device. The circuit in Figure 24 and Figure 25 can deliver up to 4 amps to the load. The 0.1 μF capacitor is required only if the load has a significant capacitive component. If the load is purely resistive, improved high frequency supply rejection results can be obtained by removing the capacitor.

# AD586



Figure 24. Precision High Current Current Source



Figure 25. Precision High Current Voltage Source

# OUTLINE DIMENSIONS



COMPLIANT TO JEDEC STANDARDS MS-001-BA  
 CONTROLLING DIMENSIONS ARE IN INCHES; MILLIMETER DIMENSIONS (IN PARENTHESES) ARE ROUNDED-OFF INCH EQUIVALENTS FOR REFERENCE ONLY AND ARE NOT APPROPRIATE FOR USE IN DESIGN. CORNER LEADS MAY BE CONFIGURED AS WHOLE OR HALF LEADS.

Figure 26. 8-Lead Plastic Dual In-Line Package [PDIP] (N-8)  
 Dimensions shown in inches and (millimeters)



COMPLIANT TO JEDEC STANDARDS MS-012AA  
 CONTROLLING DIMENSIONS ARE IN MILLIMETERS; INCH DIMENSIONS (IN PARENTHESES) ARE ROUNDED-OFF MILLIMETER EQUIVALENTS FOR REFERENCE ONLY AND ARE NOT APPROPRIATE FOR USE IN DESIGN

Figure 28. 8-Lead Standard Small Outline Package [SOIC] Narrow Body (R-8)  
 Dimensions shown in millimeters and (inches)

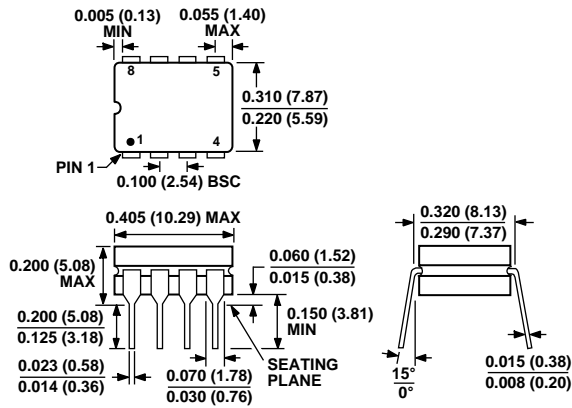

CONTROLLING DIMENSIONS ARE IN INCHES; MILLIMETER DIMENSIONS (IN PARENTHESES) ARE ROUNDED-OFF INCH EQUIVALENTS FOR REFERENCE ONLY AND ARE NOT APPROPRIATE FOR USE IN DESIGN.

Figure 27. 8-Lead Ceramic Dual In-Line Package [CERDIP] (Q-8)  
 Dimensions shown in inches and (millimeters)

# AD586

## ORDERING GUIDE

Model	Initial Error	Temperature Coefficient	Temperature Range	Package Description	Package Option	Quantity Per Reel
AD586JN	20 mV	25 ppm/°C	0°C to 70°C	PDIP	N-8	
AD586JNZ <sup>1</sup>	20 mV	25 ppm/°C	0°C to 70°C	PDIP	N-8	
AD586JQ	20 mV	25 ppm/°C	0°C to 70°C	CERDIP	Q-8	
AD586JR	20 mV	25 ppm/°C	0°C to 70°C	SOIC	R-8	
AD586JR-REEL7	20 mV	25 ppm/°C	0°C to 70°C	SOIC	R-8	1,000
AD586JRZ <sup>1</sup>	20 mV	25 ppm/°C	0°C to 70°C	SOIC	R-8	
AD586JRZ-REEL7 <sup>1</sup>	20 mV	25 ppm/°C	0°C to 70°C	SOIC	R-8	1,000
AD586KN	5 mV	15 ppm/°C	0°C to 70°C	PDIP	N-8	
AD586KNZ <sup>1</sup>	5 mV	15 ppm/°C	0°C to 70°C	PDIP	N-8	
AD586KQ	5 mV	15 ppm/°C	0°C to 70°C	CERDIP	Q-8	
AD586KR	5 mV	15 ppm/°C	0°C to 70°C	SOIC	R-8	
AD586KR-REEL	5 mV	15 ppm/°C	0°C to 70°C	SOIC	R-8	2,500
AD586KR-REEL7	5 mV	15 ppm/°C	0°C to 70°C	SOIC	R-8	1,000
AD586KRZ <sup>1</sup>	5 mV	15 ppm/°C	0°C to 70°C	SOIC	R-8	
AD586KRZ-REEL <sup>1</sup>	5 mV	15 ppm/°C	0°C to 70°C	SOIC	R-8	2,500
AD586KRZ-REEL7 <sup>1</sup>	5 mV	15 ppm/°C	0°C to 70°C	SOIC	R-8	1,000
AD586LN	2.5 mV	5 ppm/°C	0°C to 70°C	PDIP	N-8	
AD586LNZ <sup>1</sup>	2.5 mV	5 ppm/°C	0°C to 70°C	PDIP	N-8	
AD586LR	2.5 mV	5 ppm/°C	0°C to 70°C	SOIC	R-8	
AD586LR-REEL	2.5 mV	5 ppm/°C	0°C to 70°C	SOIC	R-8	2,500
AD586LR-REEL7	2.5 mV	5 ppm/°C	0°C to 70°C	SOIC	R-8	1,000
AD586LRZ <sup>1</sup>	2.5 mV	5 ppm/°C	0°C to 70°C	SOIC	R-8	
AD586LRZ-REEL <sup>1</sup>	2.5 mV	5 ppm/°C	0°C to 70°C	SOIC	R-8	2,500
AD586LRZ-REEL7 <sup>1</sup>	2.5 mV	5 ppm/°C	0°C to 70°C	SOIC	R-8	1,000
AD586MN	2 mV	2 ppm/°C	0°C to 70°C	PDIP	N-8	
AD586MNZ <sup>1</sup>	2 mV	2 ppm/°C	0°C to 70°C	PDIP	N-8	
AD586AR	5 mV	15 ppm/°C	-40°C to +85°C	SOIC	R-8	
AD586AR-REEL	5 mV	15 ppm/°C	-40°C to +85°C	SOIC	R-8	2,500
AD586ARZ <sup>1</sup>	5 mV	15 ppm/°C	-40°C to +85°C	SOIC	R-8	
AD586ARZ-REEL <sup>1</sup>	5 mV	15 ppm/°C	-40°C to +85°C	SOIC	R-8	2,500
AD586ARZ-REEL7 <sup>1</sup>	5 mV	15 ppm/°C	-40°C to +85°C	SOIC	R-8	1,000
AD586BR	2.5 mV	5 ppm/°C	-40°C to +85°C	SOIC	R-8	
AD586BR-REEL7	2.5 mV	5 ppm/°C	-40°C to +85°C	SOIC	R-8	1,000
AD586BRZ <sup>1</sup>	2.5 mV	5 ppm/°C	-40°C to +85°C	SOIC	R-8	
AD586BRZ-REEL <sup>1</sup>	2.5 mV	5 ppm/°C	-40°C to +85°C	SOIC	R-8	2,500
AD586BRZ-REEL7 <sup>1</sup>	2.5 mV	5 ppm/°C	-40°C to +85°C	SOIC	R-8	1,000
AD586LQ	2.5 mV	5 ppm/°C	0°C to 70°C	CERDIP	Q-8	
AD586SQ	10 mV	20 ppm/°C	-55°C to +125°C	CERDIP	Q-8	
AD586TQ	2.5 mV	10 ppm/°C	-55°C to +125°C	CERDIP	Q-8	
AD586TQ/883B <sup>2</sup>	2.5 mV	10 ppm/°C	-55°C to +125°C	CERDIP	Q-8	

<sup>1</sup> Z = Pb-free part.

<sup>2</sup> For details on grade and package offerings screened in accordance with MIL-STD-883, refer to the Analog Devices Military Products Databook or the current AD586/883B data sheet.

**NOTES**

**AD586**

**NOTES**