

G3VM-41GR4

MOS FET Relays

MOS FET Relays with Low Output Capacitance and ON Resistance ($C \times R = 10\text{pF} \cdot \Omega$) in a 40-V Load Voltage Model.



- ON resistance of 2 Ω (typical) suppresses output signal attenuation.
- Leakage current of 1.0 nA max. when output relay is open.

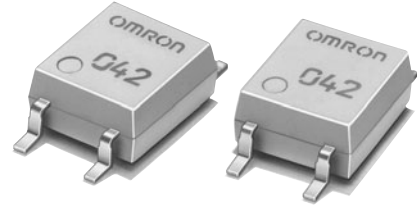

Note: The actual product is marked differently from the image shown here.

RoHS compliant

Application Examples

- Semiconductor test equipment
- Test & Measurement equipment
- Communication equipment
- Data loggers

Terminal Arrangement/Internal Connections

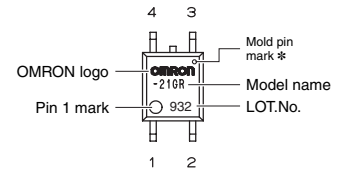
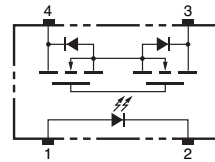

Note: The actual product is marked differently from the image shown here.
* The indentation in the corner diagonally opposite from the pin 1 mark is from a pin on the mold.

List of Models

Package type	Contact form	Terminals	Load voltage (peak value) *	Model	Minimum package quantity	
					Number per tube	Number per tape and reel
SOP4	1a (SPST-NO)	Surface-mounting Terminals	40 V	G3VM-41GR4	100	-
				G3VM-41GR4 (TR)	-	2,500

* The AC peak and DC value are given for the load voltage.

Absolute Maximum Ratings ($T_a = 25^\circ\text{C}$)

Item	Symbol	Rating	Unit	Measurement conditions	
Input	LED forward current	I_F	50	mA	
	LED forward current reduction rate	$\Delta I_F / ^\circ\text{C}$	-0.5	mA/ $^\circ\text{C}$	$T_a \geq 25^\circ\text{C}$
	LED reverse voltage	V_R	5	V	
	Connection temperature	T_J	125	$^\circ\text{C}$	
Output	Load voltage (AC peak/DC)	V_{OFF}	40	V	
	Continuous load current (AC peak/DC)	I_o	250	mA	
	ON current reduction rate	$\Delta I_o / ^\circ\text{C}$	-2.5	mA/ $^\circ\text{C}$	$T_a \geq 25^\circ\text{C}$
	Connection temperature	T_J	125	$^\circ\text{C}$	
Dielectric strength between I/O (See note 1.)	V_{I-O}	1500	V _{rms}	AC for 1 min	
Ambient operating temperature	T_a	-20 to +85	$^\circ\text{C}$	With no icing or condensation	
Ambient storage temperature	T_{stg}	-55 to +125	$^\circ\text{C}$	With no icing or condensation	
Soldering temperature	-	260	$^\circ\text{C}$	10 s	

Note: 1. The dielectric strength between the input and output was checked by applying voltage between all pins as a group on the LED side and all pins as a group on the light-receiving side.

Electrical Characteristics ($T_a = 25^\circ\text{C}$)

Item	Symbol	Minimum	Typical	Maximum	Unit	Measurement conditions	
Input	LED forward voltage	V_F	1.0	1.15	1.3	V	$I_F = 10\text{ mA}$
	Reverse current	I_R	-	-	10	μA	$V_R = 5\text{ V}$
	Capacity between terminals	C_T	-	15	-	pF	$V = 0, f = 1\text{ MHz}$
	Trigger LED forward current	I_{FT}	-	-	4	mA	$I_o = 100\text{ mA}$
Output	Maximum resistance with output ON	R_{ON}	-	2.0	3.0	Ω	$I_F = 5\text{ mA}, I_o = 250\text{ mA}, t < 1\text{ s}$
	Current leakage when the relay is open	I_{LEAK}	-	-	1.0	nA	$V_{OFF} = 30\text{ V}, T_a = 50^\circ\text{C}$
	Capacity between terminals	C_{OFF}	-	5	7	pF	$V = 0, f = 100\text{ MHz}, t < 1\text{ s}$
	Capacity between I/O terminals	C_{I-O}	-	0.8	-	pF	$f = 1\text{ MHz}, V_s = 0\text{ V}$
Insulation resistance between I/O terminals	R_{I-O}	1000	-	-	M Ω	$V_{I-O} = 500\text{ VDC}, R_oH \leq 60\%$	
Turn-ON time	t_{ON}	-	-	0.5	ms	$I_F = 10\text{ mA}, R_L = 200\ \Omega, V_{DD} = 20\text{ V}$ (See note 2.)	
Turn-OFF time	t_{OFF}	-	-	0.5	ms		

Note: 2. Turn-ON and Turn-OFF Times

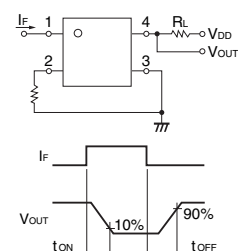

Recommended Operating Conditions

Use the G3VM under the following conditions so that the Relay will operate properly.

Item	Symbol	Minimum	Typical	Maximum	Unit
Load voltage (AC peak/DC)	V _{DD}	-	-	32	V
Operating LED forward current	I _F	10	-	30	mA
Continuous load current (AC peak/DC)	I _O	-	-	250	mA
Ambient operating temperature	T _a	25	-	60	°C

Engineering Data

LED forward current vs. Ambient temperature

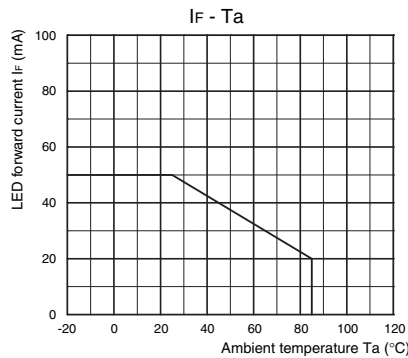

Continuous load current vs. Ambient temperature

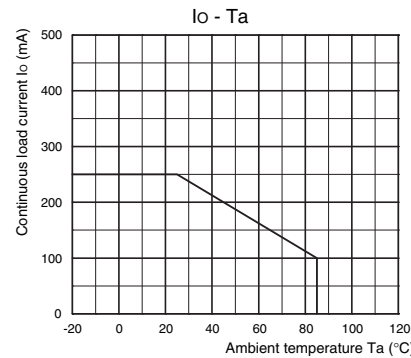

LED forward current vs. LED forward voltage

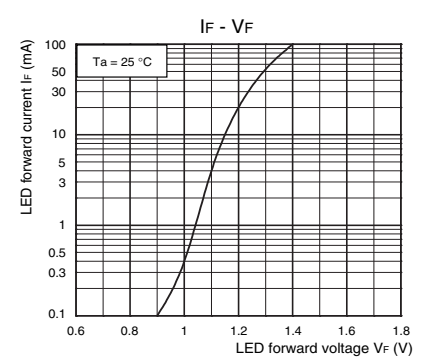

Continuous load current vs. On-state voltage

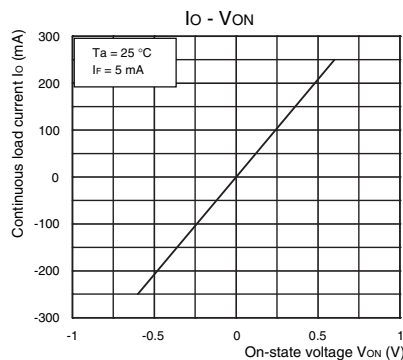

On-state resistance vs. Ambient temperature

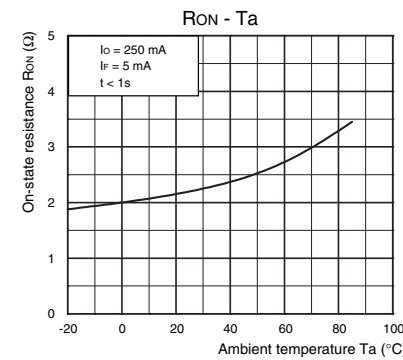

Trigger LED forward current vs. Ambient temperature

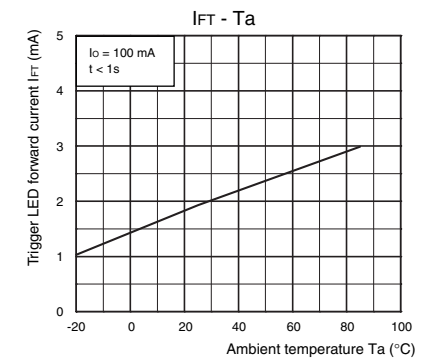

Turn ON, Turn OFF time vs. LED forward current

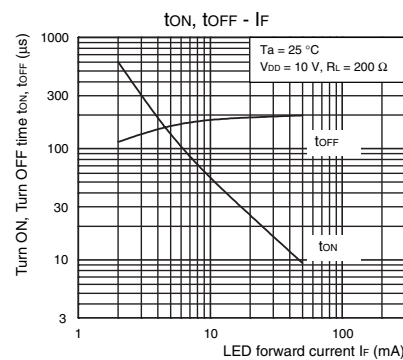

Turn ON, Turn OFF time vs. Ambient temperature

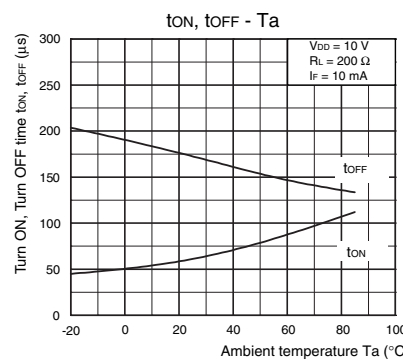

Current leakage vs. Load voltage

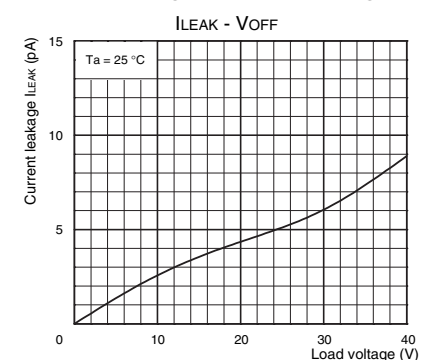

Output terminal capacitance vs. Load voltage

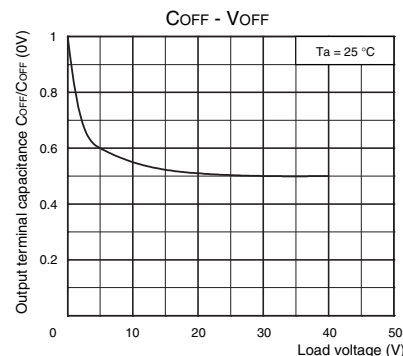

Safety Precautions

- Refer to "Common Precautions" for all G3VM models.

■ Appearance

SOP (Small Outline Package)

SOP4

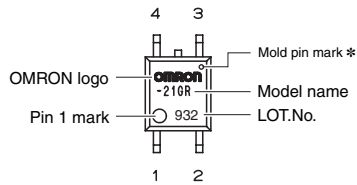

Note: The actual product is marked differently from the image shown here.

* The indentation in the corner diagonally opposite from the pin 1 mark is from a pin on the mold.

■ Dimensions

(Unit: mm)

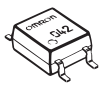

Surface-mounting Terminals

Weight: 0.1 g

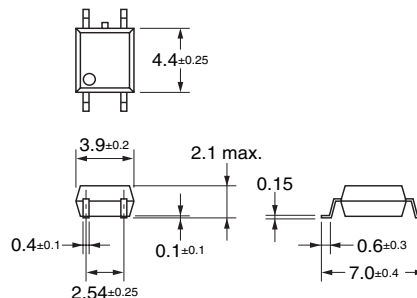

Actual Mounting Pad Dimensions

(Recommended Value, TOP VIEW)

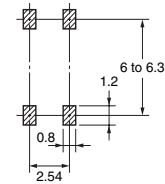

Note: The actual product is marked differently from the image shown here.

- Application examples provided in this document are for reference only. In actual applications, confirm equipment functions and safety before using the product.
- Consult your OMRON representative before using the product under conditions which are not described in the manual or applying the product to nuclear control systems, railroad systems, aviation systems, vehicles, combustion systems, medical equipment, amusement machines, safety equipment, and other systems or equipment that may have a serious influence on lives and property if used improperly. Make sure that the ratings and performance characteristics of the product provide a margin of safety for the system or equipment, and be sure to provide the system or equipment with double safety mechanisms.

Note: Do not use this document to operate the Unit.

OMRON Corporation

ELECTRONIC AND MECHANICAL COMPONENTS COMPANY

Contact: www.omron.com/ecb

Cat. No. **K184-E1-01**
0412(0412)(O)