

# CRD Series 10mm DIP Coded Rotary Switches



H

DIP

## Features/Benefits

- **Process sealed – withstands soldering and cleaning**
- **Thru-hole and surface mount models**
- **Crisp, positive detent ensures actuation**
- **Computer and peripherals**
- **RoHS compliant**

## Typical Applications

- **Address switching applications**
- **Data storage devices**
- **Computer and peripherals**
- **Instrumentation**

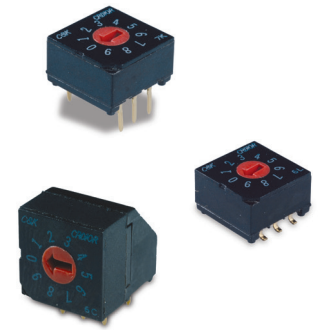

## Specifications

CONTACT RATING: 0.4 V AC, DC 20 V max.  
 ELECTRICAL LIFE: 20,000 steps min. @ 5 V DC 10 mA.  
 MECHANICAL LIFE: 30,000 steps min.  
 CONTACT RESISTANCE: 100 milliohms max. initial @ 2 V DC 10 mA.  
 INSULATION RESISTANCE: 1000 megohms min. @ 100 V DC  
 DIELECTRIC STRENGTH: 300 V AC for 1 minute.  
 OPERATING TEMPERATURE: -20°C to 85°C.  
 STORAGE TEMPERATURE: -40°C to 85°C.  
 OPERATING FORCE: 1000 grams max.  
 PACKAGING: Switches supplied in anti-static tubes in full quantities only. This may affect order quantity. Surface mount models with M0 actuators available in tape and reel, 500 pieces per reel.

## Materials

COVER: PPS (black)  
 HOUSING: PPS (black)  
 ACTUATOR: PA 6T M0 actuator option; PBT L1 and W1 actuator option.  
 CONTACTS: Beryllium Copper with Gold over Nickel plate  
 TERMINALS: Brass with Gold Nickel plate.

**Note:** Specifications and materials listed above are for switches with standard options. For information on specific and custom switches, consult Customer Service Center.

## How To Order

The Build-A Switch concept allows you to mix and match options to create the switch you need. Below is a complete listing of options shown in catalog. To order, simply select desired option from each category and place in the appropriate box.

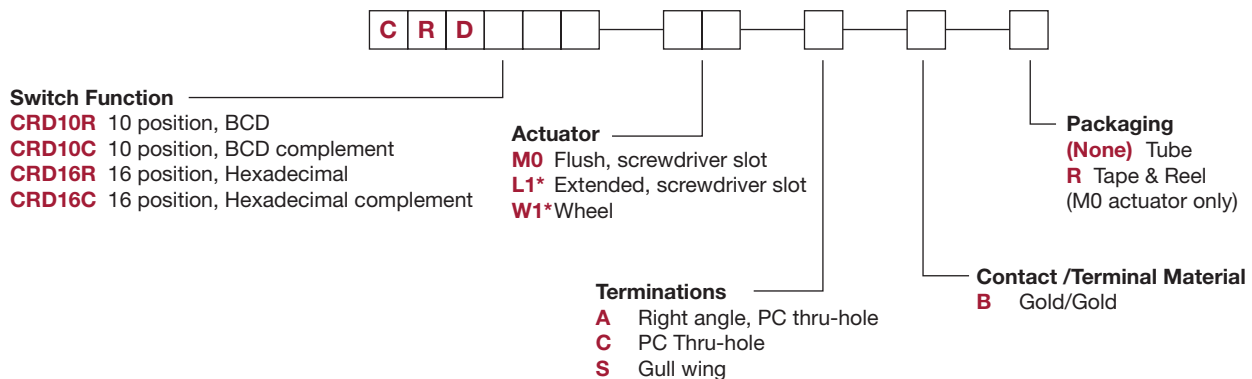

\* Note - L1 and W1 actuators are not available in termination "S"

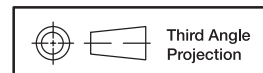

Dimensions are shown: Inch (mm)  
 Specifications and dimensions subject to change



# CRD Series 10mm DIP Coded Rotary Switches

## SWITCHES WITH STANDARD OPTIONS

### PC Mount

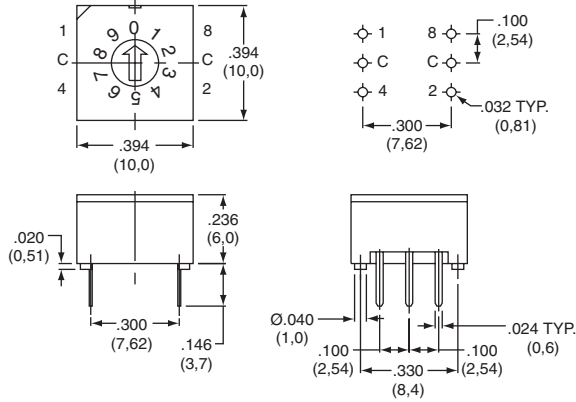
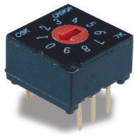

PART NUMBER	NO. POS.	QUANTITY PER TUBE
<b>CRD10RM0CB</b>	10	45
<b>CRD16RM0CB</b>	16	45

### Right Angle Mount

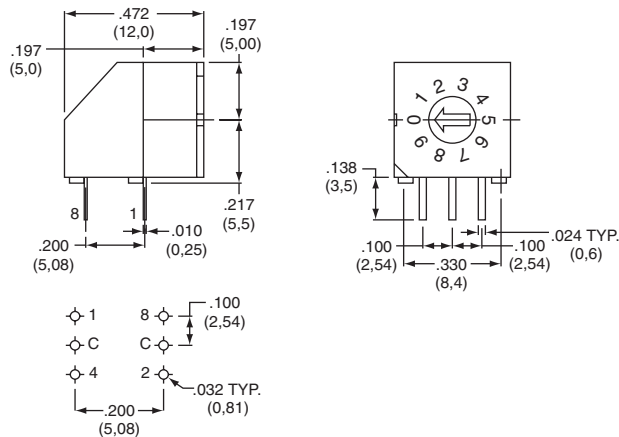

PART NUMBER	NO. POS.	QUANTITY PER TUBE
<b>CRD10RM0AB</b>	10	45
<b>CRD16RM0AB</b>	16	45

### Surface Mount

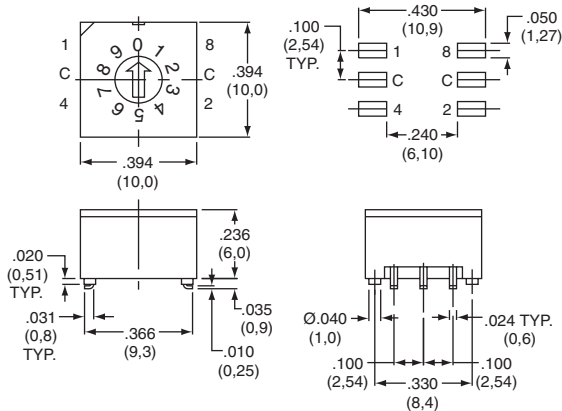

PART NUMBER	NO. POS.	QUANTITY PER TUBE
<b>CRD10RM0SB</b>	10	45
<b>CRD16RM0SB</b>	16	45



Third Angle Projection  
Dimensions are shown: Inch (mm)  
Specifications and dimensions subject to change

# CRD Series 10mm DIP Coded Rotary Switches

## SWITCH FUNCTION

### CRD10R

10 POSITION, BCD  
ACTUATOR COLOR: RED

POS.	0	1	2	3	4	5	6	7	8	9
C	●	●	●	●	●	●	●	●	●	●
1		●					●		●	●
2			●						●	●
4					●	●	●			
8									●	●

Switches ship and to be solder processed in position "0"

### CRD10C

10 POSITION, BCD COMPLEMENT  
ACTUATOR COLOR: ORANGE

POS.	0	1	2	3	4	5	6	7	8	9
C	●	●	●	●	●	●	●	●	●	●
1	●		●		●		●		●	●
2	●		●		●		●		●	●
4	●	●	●	●					●	●
8	●	●	●	●	●	●	●	●		

Switches ship and to be solder processed in position "7"

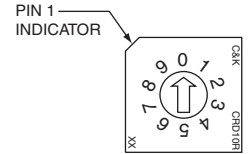

### CRD16R

16 POSITION, HEXADECIMAL  
ACTUATOR COLOR: BLACK

POS.	0	1	2	3	4	5	6	7	8	9	A	B	C	D	E	F
C	●	●	●	●	●	●	●	●	●	●	●	●	●	●	●	●
1		●														
2			●													
4					●	●	●									
8									●	●	●	●	●	●	●	●

Switches ship and to be solder processed in position "0"

### CRD16C

16 POSITION, HEXADECIMAL COMPLEMENT  
ACTUATOR COLOR: WHITE

POS.	0	1	2	3	4	5	6	7	8	9	A	B	C	D	E	F
C	●	●	●	●	●	●	●	●	●	●	●	●	●	●	●	●
1	●		●		●		●		●		●		●		●	●
2	●		●		●		●		●		●		●		●	●
4	●	●	●	●					●	●	●	●				
8	●	●	●	●	●	●	●	●								

Switches ship and to be solder processed in position "F"

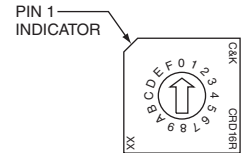

## ACTUATOR

(STD.) FLUSH WITH SCREWDRIVER SLOT

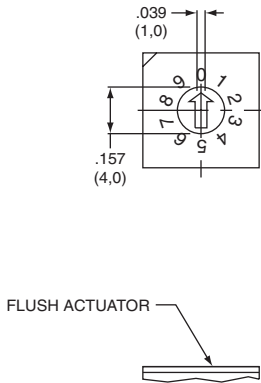

### L1\*

EXTENDED WITH SCREWDRIVER SLOT

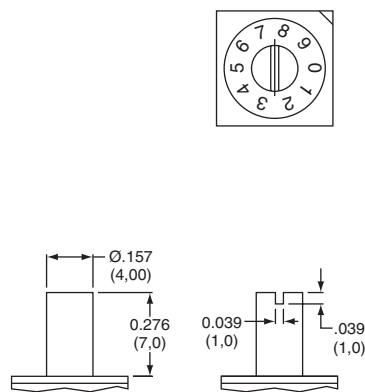

### W1\*

WHEEL

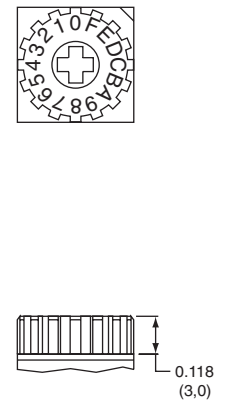

**NOTE:** Designed for #0 Phillips screwdriver.

\* L1 and W1 actuators are not available in termination "S"

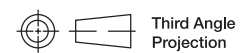

Dimensions are shown: Inch (mm)  
Specifications and dimensions subject to change

# CRD Series 10mm DIP Coded Rotary Switches

## TERMINATIONS



DIP I

### C PC, THRU-HOLE

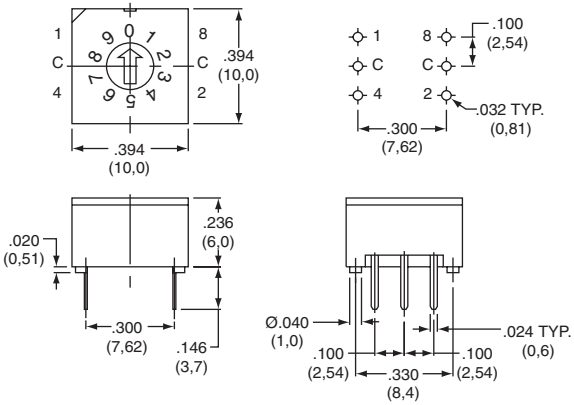

### A RIGHT ANGLE, PC THRU-HOLE

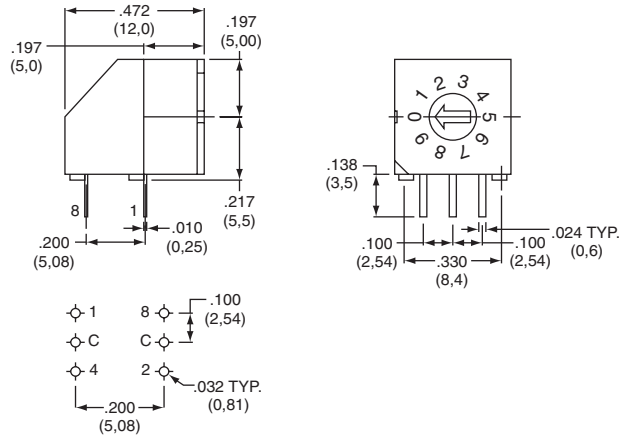

### S SURFACE MOUNT

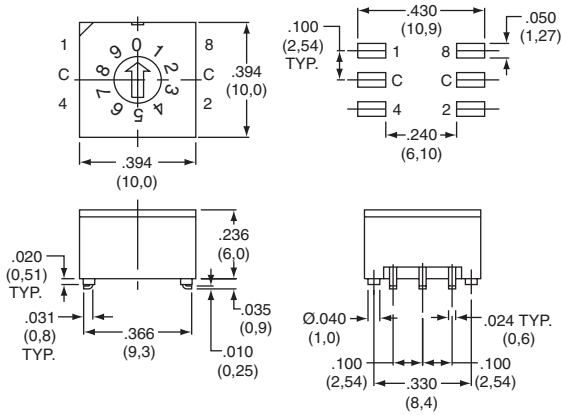

### MO

## CONTACT MATERIAL



OPTION CODE	RoHS COMPLIANT*	RoHS COMPATIBLE*	CONTACT MATERIAL	TERMINAL PLATING	RATING	
<b>B</b>	YES	YES	GOLD	GOLD	LOW LEVEL/DRY CIRCUIT	0.4 VC MAX. @ 20 V AC or DC MAX.

\* Note: See Technical Data section of this catalog for RoHS compliant and compatible definitions and specifications.

## TAPE & REEL

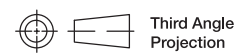
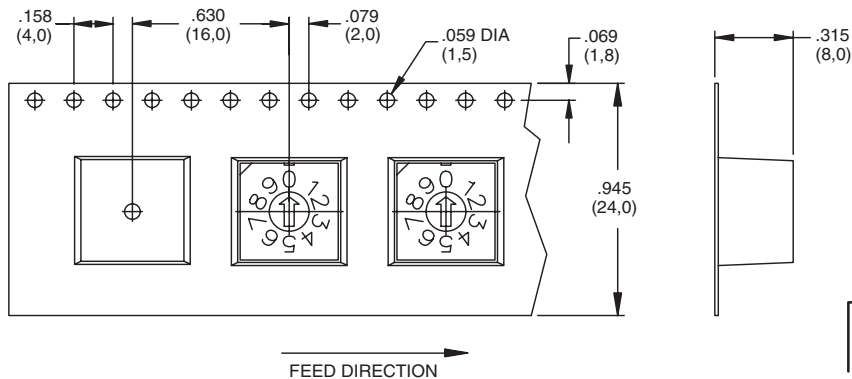

Dimensions are shown: Inch (mm)  
Specifications and dimensions subject to change