



## 16 Ω, Low Parasitic Capacitance and Leakage, +12 V / +5 V / +3 V / ± 5 V Quad SPST Switches

### DESCRIPTION

The DG411LE, DG412LE, and DG413LE are monolithic quad single-pole-single-throw analog switches. The DG411LE and DG412LE differ only in that they respond to opposite logic levels. The DG413LE has two normally open and two normally closed switches. It can be given various configurations, including four SPST, two SPDT, and one DPDT.

The DG411LE, DG412LE, and DG413LE offer low on resistance of 16 Ω, low parasitic capacitance of 15 pF switch on capacitance, and low charge injection over the signal swing range.

The DG411LE, DG412LE, and DG413LE operate on single and dual supplies. Single supply voltage ranges from 3 V to 16 V while dual supply operation is recommended with ± 3 V to ± 8 V. Each switch conducts equally well in both direction when on, and blocks input voltages up to the supply levels when off.

The DG411LE, DG412LE, and DG413LE are available in 16 lead TSSOP, SOIC, and PDIP packages.

### FEATURES

- 3 V to 16 V single supply or ± 3 V to ± 8 V dual supply
- On-resistance  $R_{DS(on)}$ : 16 Ω
- Low parasitic capacitance:
  - $C_{D(ON)}$ : 15 pF
  - $C_{S(OFF)}$ : 5 pF
- Less than 8 pC charge injection over the full signal swing range
- Fast switching  $t_{ON}$ : 16 ns  
 $t_{OFF}$ : 9 ns
- TTL, CMOS compatible
- Material categorization: for definitions of compliance please see [www.vishay.com/doc?99912](http://www.vishay.com/doc?99912)



### Note

\* This datasheet provides information about parts that are RoHS-compliant and / or parts that are non-RoHS-compliant. For example, parts with lead (Pb) terminations are not RoHS-compliant. Please see the information / tables in this datasheet for details.

### BENEFITS

- Wide operation voltage range
- Low signal errors and distortion
- Fast switching time
- Minimized switching glitch

### APPLICATIONS

- Automatic test equipment
- Data acquisition systems
- Meters and instruments
- Medical and healthcare systems
- Communication systems
- Audio and video signal routing
- Relay replacement
- Battery powered systems
- Computer peripherals
- Audio and video signal routing

### FUNCTIONAL BLOCK DIAGRAM AND PIN CONFIGURATION

DG411LE, DG412LE  
Dual-In-Line, TSSOP and SOIC



DG413LE  
Dual-In-Line, TSSOP and SOIC

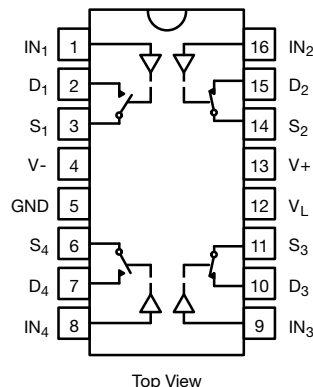



TRUTH TABLE		
LOGIC	DG411LE	DG412LE
0	ON	OFF
1	OFF	ON

Logic "0"  $\leq 0.8$  VLogic "1"  $\geq 2.4$  V

TRUTH TABLE		
LOGIC	SW <sub>1</sub> , SW <sub>4</sub>	SW <sub>2</sub> , SW <sub>3</sub>
0	OFF	ON
1	ON	OFF

Logic "0"  $\leq 0.8$  VLogic "1"  $\geq 2.4$  V

ORDERING INFORMATION					
TEMP. RANGE	CONFIGURATION	PACKAGE	PART NUMBER	MIN. ORDER / PACK. QUANTITY	
-40 °C to +85 °C Lead-free	DG411LE	16-pin TSSOP	DG411LEDQ-GE3	Tube 360 units	
			DG411LEDQ-T1-GE3	Tape and reel, 3000 units	
		16-pin SOIC	DG411LEDY-GE3	Tube 500 units	
			DG411LEDY-T1-GE3	Tape and reel, 2500 units	
		16-pin PDIP	DG411LEDJ-GE3	Tube 500 units	
			DG412LEDQ-GE3	Tube 360 units	
	DG412LE	16-pin TSSOP	DG412LEDQ-T1-GE3	Tape and reel, 3000 units	
			DG412LEDY-GE3	Tube 500 units	
		16-pin SOIC	DG412LEDY-T1-GE3	Tape and reel, 2500 units	
			DG412LEDJ-GE3	Tube 500 units	
		DG413LE	16-pin TSSOP	DG413LEDQ-GE3	Tube 360 units
				DG413LEDQ-T1-GE3	Tape and reel, 3000 units
16-pin SOIC	DG413LEDY-GE3		Tube 500 units		
	DG413LEDY-T1-GE3		Tape and reel, 2500 units		
16-pin PDIP	DG413LEDJ-GE3	Tube 500 units			

ABSOLUTE MAXIMUM RATINGS			
PARAMETER	LIMIT	UNIT	
V <sub>+</sub> to V <sub>-</sub>	-0.3 to +18	V	
GND to V <sub>-</sub>	18		
V <sub>L</sub>	(GND -0.3) to (V <sub>+</sub> ) +0.3		
I <sub>N</sub> <sup>a</sup> , V <sub>S</sub> , V <sub>D</sub>	-0.3 to (V <sub>+</sub> ) +0.3 or 30 mA, whichever occurs first		
Continuous Current (Any terminal)	30	mA	
Peak Current, S or D (Pulsed 1 ms, 10 % duty cycle)	100		
Storage Temperature	(DQ, DY suffix)	-65 to +125	°C
	(AK suffix)	-65 to +150	
Power Dissipation (Packages) <sup>b</sup>	16-pin TSSOP <sup>c</sup>	450	mW
	16-pin SOIC <sup>d</sup>	650	
	16-pin CerDIP <sup>e</sup>	900	
ESD Human Body Model (HBM); per ANSI / ESDA / JEDEC <sup>®</sup> JS-001	2500	V	
Latch Up Current, per JESD78D	400	mA	

**Notes**

- Signals on S<sub>x</sub>, D<sub>x</sub>, or I<sub>Nx</sub> exceeding V<sub>+</sub> or V<sub>-</sub> will be clamped by internal diodes. Limit forward diode current to maximum current ratings.
- All leads welded or soldered to PC board.
- Derate 7 mW/°C above 75 °C.
- Derate 7.6 mW/°C above 75 °C
- Derate 12 mW/°C above 75 °C.

Stresses beyond those listed under "Absolute Maximum Ratings" may cause permanent damage to the device. These are stress ratings only, and functional operation of the device at these or any other conditions beyond those indicated in the operational sections of the specifications is not implied. Exposure to absolute maximum rating conditions for extended periods may affect device reliability.



SPECIFICATIONS <sup>a</sup> (Single Supply 12 V)									
PARAMETER	SYMBOL	TEST CONDITIONS UNLESS OTHERWISE SPECIFIED V <sub>+</sub> = 12 V, V <sub>-</sub> = 0 V V <sub>L</sub> = 5 V, V <sub>IN</sub> = 2.4 V, 0.8 V <sup>f</sup>	TEMP. <sup>b</sup>	TYP. <sup>c</sup>	A SUFFIX LIMITS -55 °C to +125 °C		D SUFFIX LIMITS -40 °C to +85 °C		UNIT
					MIN. <sup>d</sup>	MAX. <sup>d</sup>	MIN. <sup>d</sup>	MAX. <sup>d</sup>	
					<b>Analog Switch</b>				
Analog Signal Range <sup>e</sup>	V <sub>ANALOG</sub>		Full	-	0	12	0	12	V
Drain-Source On-Resistance	R <sub>DS(on)</sub>	V <sub>+</sub> = 10.8 V, V <sub>-</sub> = 0 V I <sub>S</sub> = 10 mA, V <sub>D</sub> = 2/9 V	Room	16	-	26	-	26	Ω
			Full	-	-	40	-	35	
Switch Off Leakage Current	I <sub>S(off)</sub>	V <sub>D</sub> = 1/11 V, V <sub>S</sub> = 11/1 V	Room	-	-1	1	-1	1	nA
			Full	-	-15	15	-10	10	
	I <sub>D(off)</sub>		Room	-	-1	1	-1	1	
			Full	-	-15	15	-10	10	
Channel On Leakage Current	I <sub>D(on)</sub>	V <sub>S</sub> = V <sub>D</sub> = 11/1 V	Room	-	-1	1	-1	1	
			Full	-	-15	15	-10	10	
<b>Digital Control</b>									
Input Current, VIN Low	I <sub>IL</sub>	V <sub>IN</sub> under test = 0.8 V	Full	0.01	-1.5	1.5	-1	1	μA
Input Current, VIN High	I <sub>IH</sub>	V <sub>IN</sub> under test = 2.4 V	Full		-1.5	1.5	-1	1	
<b>Dynamic Characteristics</b>									
Turn-On Time	t <sub>ON</sub>	R <sub>L</sub> = 300 Ω, C <sub>L</sub> = 35 pF, V <sub>S</sub> = 5 V, see figure 2	Room	16	-	50	-	50	ns
			Full	-	-	70	-	60	
Turn-Off Time	t <sub>OFF</sub>		Room	9	-	30	-	30	
			Full	-	-	48	-	40	
Break-Before-Make Time Delay	t <sub>D</sub>	DG413L only, V <sub>S</sub> = 5 V, R <sub>L</sub> = 300 Ω, C <sub>L</sub> = 35 pF	Room	5	-	-	-	-	
Charge Injection <sup>e</sup>	Q	V <sub>g</sub> = 0 V, R <sub>g</sub> = 0 Ω, C <sub>L</sub> = 10 nF	Room	6.6	-	-	-	-	pC
Off-Isolation <sup>e</sup>	OIRR	R <sub>L</sub> = 50 Ω, C <sub>L</sub> = 5 pF, f = 1 MHz	Room	68.4	-	-	-	-	dB
Channel-to-Channel Crosstalk <sup>e</sup>	X <sub>TALK</sub>		Room	114	-	-	-	-	
Source Off Capacitance <sup>e</sup>	C <sub>S(off)</sub>		f = 1 MHz	Room	5	-	-	-	-
Drain Off Capacitance <sup>e</sup>	C <sub>D(off)</sub>	Room		6	-	-	-	-	
Channel-On Capacitance <sup>e</sup>	C <sub>D(on)</sub>	Room		15	-	-	-	-	
<b>Power Supplies</b>									
Positive Supply Current	I <sub>+</sub>	V <sub>IN</sub> = 0 V or 5 V	Room	0.02	-	1	-	1	μA
			Full	-	-	7.5	-	5	
Negative Supply Current	I <sub>-</sub>		Room	-0.002	-1	-	-1	-	
			Full	-	-7.5	-	-5	-	
Logic Supply Current	I <sub>L</sub>		Room	0.002	-	1	-	1	
			Full	-	-	7.5	-	5	
Ground Current	I <sub>GND</sub>		Room	-0.002	-1	-	-1	-	
			Full	-	-7.5	-	-5	-	

**Notes**

- a. Refer to PROCESS OPTION FLOWCHART.
- b. Room = 25 °C, full = as determined by the operating temperature suffix.
- c. Typical values are for DESIGN AID ONLY, not guaranteed nor subject to production testing.
- d. The algebraic convention whereby the most negative value is a minimum and the most positive a maximum, is used in this datasheet.
- e. Guaranteed by design, not subject to production test.
- f. V<sub>IN</sub> = input voltage to perform proper function.
- g. Leakage parameters are guaranteed by worst case test conditions and not subject to test.



SPECIFICATIONS <sup>a</sup> (Dual Supply $\pm 5$ V)										
PARAMETER	SYMBOL	TEST CONDITIONS UNLESS OTHERWISE SPECIFIED $V_+ = 5$ V, $V_- = -5$ V $V_L = 5$ V, $V_{IN} = 2.4$ V, $0.8$ V <sup>f</sup>	TEMP. <sup>b</sup>	TYP. <sup>c</sup>	A SUFFIX LIMITS -55 °C to +125 °C		D SUFFIX LIMITS -40 °C to +85 °C		UNIT	
					MIN. <sup>d</sup>	MAX. <sup>d</sup>	MIN. <sup>d</sup>	MAX. <sup>d</sup>		
<b>Analog Switch</b>										
Analog Signal Range <sup>e</sup>	$V_{ANALOG}$		Full	-	-5	5	-5	5	V	
Drain-Source On-Resistance	$R_{DS(on)}$	$V_+ = 5$ V, $V_- = -5$ V, $I_S = 10$ mA, $V_D = \pm 3.5$ V	Room	18	-	30	-	30	$\Omega$	
			Full	-	-	42	-	37		
Switch Off Leakage Current <sup>g</sup>	$I_{S(off)}$	$V_+ = 5.5$ , $V_- = -5.5$ V, $V_D = \pm 4.5$ V, $V_S = \pm 4.5$ V	Room	-	-1	1	-1	1	nA	
			Full	-	-15	15	-10	10		
	Room		-	-1	1	-1	1			
	Full		-	-15	15	-10	10			
Channel On Leakage Current <sup>g</sup>	$I_{D(on)}$	$V_+ = 5.5$ V, $V_- = -5.5$ V, $V_S = V_D = \pm 4.5$ V	Room	-	-1	1	-1	1		
			Full	-	-15	15	-10	10		
<b>Digital Control</b>										
Input Current, $V_{IN}$ Low <sup>e</sup>	$I_{IL}$	$V_{IN}$ under test = 0.8 V	Full	0.05	-1.5	1.5	-1	1	$\mu$ A	
Input Current, $V_{IN}$ High <sup>e</sup>	$I_{IH}$	$V_{IN}$ under test = 2.4 V	Full	0.05	-1.5	1.5	-1	1		
<b>Dynamic Characteristics</b>										
Turn-On Time <sup>e</sup>	$t_{ON}$	$R_L = 300 \Omega$ , $C_L = 35$ pF, $V_S = \pm 3.5$ V, see figure 2	Room	17	-	50	-	50	ns	
			Full	-	-	70	-	60		
Turn-Off Time <sup>e</sup>	$t_{OFF}$		Room	12	-	35	-	35		
			Full	-	-	50	-	40		
Break-Before-Make Time Delay <sup>e</sup>	$t_D$		DG413L only, $V_S = 3.5$ V, $R_L = 300 \Omega$ , $C_L = 35$ pF	Room	5	-	-	-		-
Charge Injection <sup>e</sup>	Q		$V_g = 0$ V, $R_g = 0 \Omega$ , $C_L = 10$ nF	Room	5.8	-	-	-		-
Off Isolation <sup>e</sup>	OIRR	$R_L = 50 \Omega$ , $C_L = 5$ pF, $f = 1$ MHz	Room	68	-	-	-	-	dB	
Channel-to-Channel Crosstalk <sup>e</sup>	$X_{TALK}$		Room	113	-	-	-	-		
Source Off Capacitance <sup>e</sup>	$C_{S(off)}$		$f = 1$ MHz	Room	5	-	-	-	-	pF
Drain Off Capacitance <sup>e</sup>	$C_{D(off)}$	Room		6	-	-	-	-		
Channel On Capacitance <sup>e</sup>	$C_{D(on)}$	Room		14	-	-	-	-		
<b>Power Supplies</b>										
Positive Supply Current <sup>e</sup>	$I_+$	$V_{IN} = 0$ V or 5 V	Room	0.03	-	1	-	1	$\mu$ A	
			Full	-	-	7.5	-	5		
Negative Supply Current <sup>e</sup>	$I_-$		Room	-0.002	-1	-	-1	-		
			Full	-	-7.5	-	-5	-		
Logic Supply Current <sup>e</sup>	$I_L$		Room	0.002	-	1	-	1		
			Full	-	-	7.5	-	5		
Ground Current <sup>e</sup>	$I_{GND}$		Room	-0.002	-1	-	-1	-		
			Full	-	-7.5	-	-5	-		

**Notes**

- a. Refer to PROCESS OPTION FLOWCHART.
- b. Room = 25 °C, full = as determined by the operating temperature suffix.
- c. Typical values are for DESIGN AID ONLY, not guaranteed nor subject to production testing.
- d. The algebraic convention whereby the most negative value is a minimum and the most positive a maximum, is used in this datasheet.
- e. Guaranteed by design, not subject to production test.
- f.  $V_{IN}$  = input voltage to perform proper function.
- g. Leakage parameters are guaranteed by worst case test conditions and not subject to test.



SPECIFICATIONS <sup>a</sup> (Single Supply 5 V)									
PARAMETER	SYMBOL	TEST CONDITIONS UNLESS OTHERWISE SPECIFIED $V_+ = 5\text{ V}$ , $V_- = 0\text{ V}$ $V_L = 5\text{ V}$ , $V_{IN} = 2.4\text{ V}$ , $0.8\text{ V}^f$	TEMP. <sup>b</sup>	TYP. <sup>c</sup>	A SUFFIX LIMITS -55 °C to +125 °C		D SUFFIX LIMITS -40 °C to +85 °C		UNIT
					MIN. <sup>d</sup>	MAX. <sup>d</sup>	MIN. <sup>d</sup>	MAX. <sup>d</sup>	
<b>Analog Switch</b>									
Analog Signal Range <sup>e</sup>	$V_{ANALOG}$		Full	-	-	5	-	5	V
Drain-Source On-Resistance <sup>e</sup>	$R_{DS(on)}$	$V_+ = 4.5\text{ V}$ , $I_S = 5\text{ mA}$ , $V_D = 1\text{ V}$ , $3.5\text{ V}$	Room	36	-	50	-	50	$\Omega$
			Full	-	-	88	-	75	
<b>Dynamic Characteristics</b>									
Turn-On Time <sup>e</sup>	$t_{ON}$	$R_L = 300\ \Omega$ , $C_L = 35\text{ pF}$ , $V_S = 3.5\text{ V}$ , see figure 2	Room	27	-	50	-	50	ns
			Hot	-	-	90	-	60	
Turn-Off Time <sup>e</sup>	$t_{OFF}$		Room	15	-	30	-	30	
			Hot	-	-	55	-	40	
Break-Before-Make Time Delay <sup>e</sup>	$t_D$	DG413L only, $V_S = 3.5\text{ V}$ , $R_L = 300\ \Omega$ , $C_L = 35\text{ pF}$	Room	11	-	-	-	-	
Charge Injection <sup>e</sup>	Q	$V_g = 0\text{ V}$ , $R_g = 0\ \Omega$ , $C_L = 10\text{ nF}$	Room	3.3	-	-	-	-	pC
<b>Power Supplies</b>									
Positive Supply Current <sup>e</sup>	I+	$V_{IN} = 0\text{ V or }5\text{ V}$	Room	0.02	-	1	-	1	$\mu\text{A}$
			Hot	-	-	7.5	-	5	
Negative Supply Current <sup>e</sup>	I-		Room	-0.002	-1	-	-1	-	
			Hot	-	-7.5	-	-5	-	
Logic Supply Current <sup>e</sup>	$I_L$		Room	0.002	-	1	-	1	
			Hot	-	-	7.5	-	5	
Ground Current <sup>e</sup>	$I_{GND}$		Room	-0.002	-1	-	-1	-	
			Hot	-	-7.5	-	-5	-	

**Notes**

- a. Refer to PROCESS OPTION FLOWCHART.
- b. Room = 25 °C, full = as determined by the operating temperature suffix.
- c. Typical values are for DESIGN AID ONLY, not guaranteed nor subject to production testing.
- d. The algebraic convention whereby the most negative value is a minimum and the most positive a maximum, is used in this datasheet.
- e. Guaranteed by design, not subject to production test.
- f.  $V_{IN}$  = input voltage to perform proper function.
- g. Leakage parameters are guaranteed by worst case test conditions and not subject to test.



SPECIFICATIONS <sup>a</sup> (Single Supply 3 V)										
PARAMETER	SYMBOL	TEST CONDITIONS UNLESS OTHERWISE SPECIFIED $V_+ = 3\text{ V}, V_- = 0\text{ V}$ $V_L = 3\text{ V}, V_{IN} = 0.4\text{ V}, 2.0\text{ V}^f$	TEMP. <sup>b</sup>	TYP. <sup>c</sup>	ASUFFIX LIMITS -55 °C to +125 °C		D SUFFIX LIMITS -40 °C to +85 °C		UNIT	
					MIN. <sup>d</sup>	MAX. <sup>d</sup>	MIN. <sup>d</sup>	MAX. <sup>d</sup>		
<b>Analog Switch</b>										
Analog Signal Range <sup>e</sup>	$V_{ANALOG}$		Full	-	0	3	0	3	V	
Drain-Source On-Resistance	$R_{DS(on)}$	$V_+ = 2.7\text{ V}, V_- = 0\text{ V},$ $I_S = 5\text{ mA}, V_D = 0.5, 2.2\text{ V}$	Room	106	-	130	-	130	$\Omega$	
			Full	-	-	150	-	140		
Switch Off Leakage Current <sup>g</sup>	$I_{S(off)}$	$V_+ = 3.3, V_- = 0\text{ V},$ $V_D = 1, 2\text{ V}, V_S = 2, 1\text{ V}$	Room	-	-1	1	-1	1	nA	
			Full	-	-15	15	-10	10		
	Room		-	-1	1	-1	1			
	Full		-	-15	15	-10	10			
Channel On Leakage Current <sup>g</sup>	$I_{D(on)}$	$V_+ = 3.3\text{ V}, V_- = 0\text{ V},$ $V_S = V_D = 1, 2\text{ V}$	Room	-	-1	1	-1	1		
			Full	-	-15	15	-10	10		
<b>Digital Control</b>										
Input Current, $V_{IN}$ Low	$I_{IL}$	$V_{IN}$ under test = 0.4 V	Full	0.005	-1.5	1.5	-1	1	$\mu\text{A}$	
Input Current, $V_{IN}$ High	$I_{IH}$	$V_{IN}$ under test = 2.4 V	Full	0.005	-1.5	1.5	-1	1		
<b>Dynamic Characteristics</b>										
Turn-On Time	$t_{ON}$	$R_L = 300\ \Omega, C_L = 35\text{ pF},$ $V_S = 1.5\text{ V},$ see figure 2	Room	57	-	85	-	85	ns	
			Full	-	-	150	-	110		
Turn-Off Time	$t_{OFF}$		Room	25	-	60	-	60		
			Full	-	-	100	-	85		
Break-Before-Make Time Delay	$t_D$		DG413L only, $V_S = 1.5\text{ V},$ $R_L = 300\ \Omega, C_L = 35\text{ pF}$	Room	24	-	-	-		-
Charge Injection <sup>e</sup>	Q		$V_g = 0\text{ V}, R_g = 0\ \Omega, C_L = 10\text{ nF}$	Room	2	-	-	-		-
Off Isolation <sup>e</sup>	OIRR	$R_L = 50\ \Omega, C_L = 5\text{ pF}, f = 1\text{ MHz}$	Room	68	-	-	-	-	dB	
Channel-to-Channel Crosstalk <sup>e</sup>	$X_{TALK}$		Room	107	-	-	-	-		
Source Off Capacitance <sup>e</sup>	$C_{S(off)}$		f = 1 MHz	Room	6	-	-	-	-	pF
Drain Off Capacitance <sup>e</sup>	$C_{D(off)}$	Room		7	-	-	-	-		
Channel On Capacitance <sup>e</sup>	$C_{D(on)}$	Room		15	-	-	-	-		

**Notes**

- a. Refer to PROCESS OPTION FLOWCHART.
- b. Room = 25 °C, full = as determined by the operating temperature suffix.
- c. Typical values are for DESIGN AID ONLY, not guaranteed nor subject to production testing.
- d. The algebraic convention whereby the most negative value is a minimum and the most positive a maximum, is used in this datasheet.
- e. Guaranteed by design, not subject to production test.
- f.  $V_{IN}$  = input voltage to perform proper function.
- g. Leakage parameters are guaranteed by worst case test conditions and not subject to test.



TYPICAL CHARACTERISTICS (25 °C, unless otherwise noted)



$R_{DS(on)}$  vs. Drain Voltage (Single Supply)



$R_{DS(on)}$  vs. Drain Voltage and Temperature (Single Supply)



$R_{DS(on)}$  vs. Drain Voltage and Temperature



Supply Current vs. Temperature

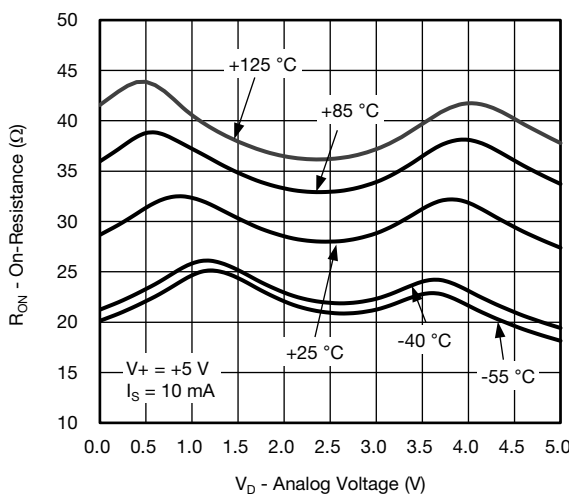

$R_{DS(on)}$  vs. Drain Voltage and Temperature

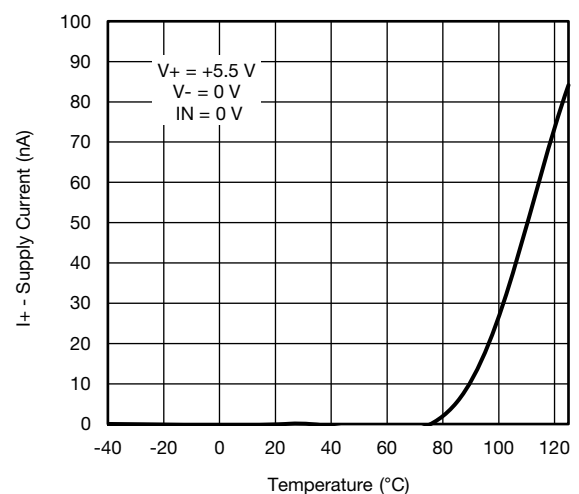

Switching Time vs. Single Supply



TYPICAL CHARACTERISTICS (25 °C, unless otherwise noted)



Leakage Current vs. Drain Voltage



Charge Injection vs. Drain Voltage



Switching Time vs. Single Supply Voltage



Threshold vs. Single Supply Current



Switching Time vs. Dual Supply Voltage



Drain Capacitance vs. Drain Voltage (Single Supply)

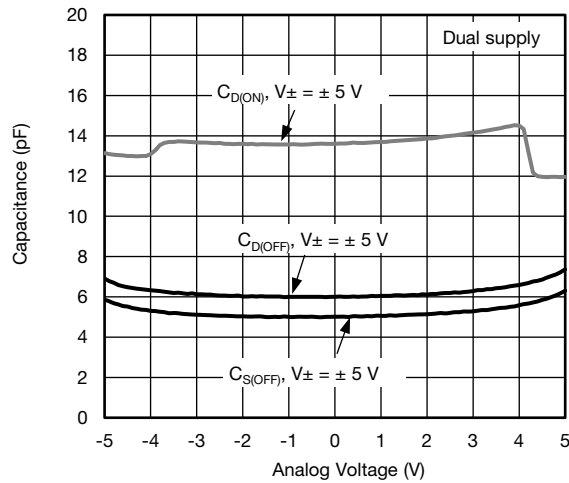

**TYPICAL CHARACTERISTICS** (25 °C, unless otherwise noted)

**Drain Capacitance vs. Drain Voltage (Dual Supply)**

**Insertion Loss, Off Isolation and Crosstalk vs. Frequency**
**SCHEMATIC DIAGRAM** (Typical Channel)

**Fig. 1**

## TEST CIRCUITS



$C_L$  (includes fixture and stray capacitance)

$$V_O = V_S \frac{R_L}{R_L + r_{DS(on)}}$$



Note: Logic input waveform is inverted for switches that have the opposite logic sense control

Fig. 2 - Switching Time



$C_L$  (includes fixture and stray capacitance)



Fig. 3 - Break-Before-Make (DG413LE)

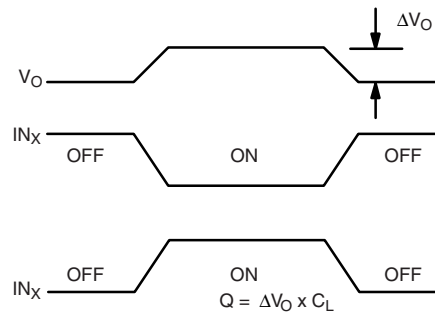

$IN_x$  dependent on switch configuration Input polarity determined by sense of switch.

Fig. 4 - Charge Injection

TEST CIRCUITS



Fig. 5 - Crosstalk



Fig. 6 - Off-Isolation



Fig. 7 - Source / Drain Capacitances

Vishay Siliconix maintains worldwide manufacturing capability. Products may be manufactured at one of several qualified locations. Reliability data for Silicon Technology and Package Reliability represent a composite of all qualified locations. For related documents such as package/tape drawings, part marking, and reliability data, see [www.vishay.com/ppg?78091](http://www.vishay.com/ppg?78091).



**SOIC (NARROW): 16-LEAD**  
JEDEC Part Number: MS-012



Dim	MILLIMETERS		INCHES	
	Min	Max	Min	Max
A	1.35	1.75	0.053	0.069
A <sub>1</sub>	0.10	0.20	0.004	0.008
B	0.38	0.51	0.015	0.020
C	0.18	0.23	0.007	0.009
D	9.80	10.00	0.385	0.393
E	3.80	4.00	0.149	0.157
e	1.27 BSC		0.050 BSC	
H	5.80	6.20	0.228	0.244
L	0.50	0.93	0.020	0.037
∅	0°	8°	0°	8°

ECN: S-03946—Rev. F, 09-Jul-01  
DWG: 5300



### PDIP: 16-LEAD



Dim	MILLIMETERS		INCHES	
	Min	Max	Min	Max
<b>A</b>	3.81	5.08	0.150	0.200
<b>A<sub>1</sub></b>	0.38	1.27	0.015	0.050
<b>B</b>	0.38	0.51	0.015	0.020
<b>B<sub>1</sub></b>	0.89	1.65	0.035	0.065
<b>C</b>	0.20	0.30	0.008	0.012
<b>D</b>	18.93	21.33	0.745	0.840
<b>E</b>	7.62	8.26	0.300	0.325
<b>E<sub>1</sub></b>	5.59	7.11	0.220	0.280
<b>e<sub>1</sub></b>	2.29	2.79	0.090	0.110
<b>e<sub>A</sub></b>	7.37	7.87	0.290	0.310
<b>L</b>	2.79	3.81	0.110	0.150
<b>Q<sub>1</sub></b>	1.27	2.03	0.050	0.080
<b>S</b>	0.38	1.52	.015	0.060

ECN: S-03946—Rev. D, 09-Jul-01  
DWG: 5482

## TSSOP: 16-LEAD

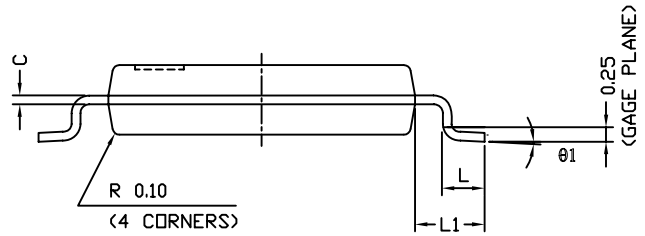
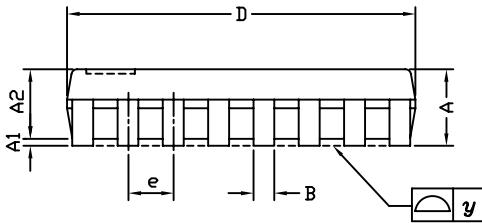
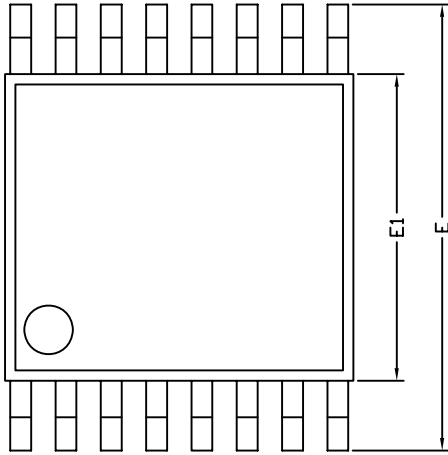

Symbols	DIMENSIONS IN MILLIMETERS		
	Min	Nom	Max
A	-	1.10	1.20
A1	0.05	0.10	0.15
A2	-	1.00	1.05
B	0.22	0.28	0.38
C	-	0.127	-
D	4.90	5.00	5.10
E	6.10	6.40	6.70
E1	4.30	4.40	4.50
e	-	0.65	-
L	0.50	0.60	0.70
L1	0.90	1.00	1.10
y	-	-	0.10
θ1	0°	3°	6°

ECN: S-61920-Rev. D, 23-Oct-06  
DWG: 5624



## RECOMMENDED MINIMUM PAD FOR TSSOP-16

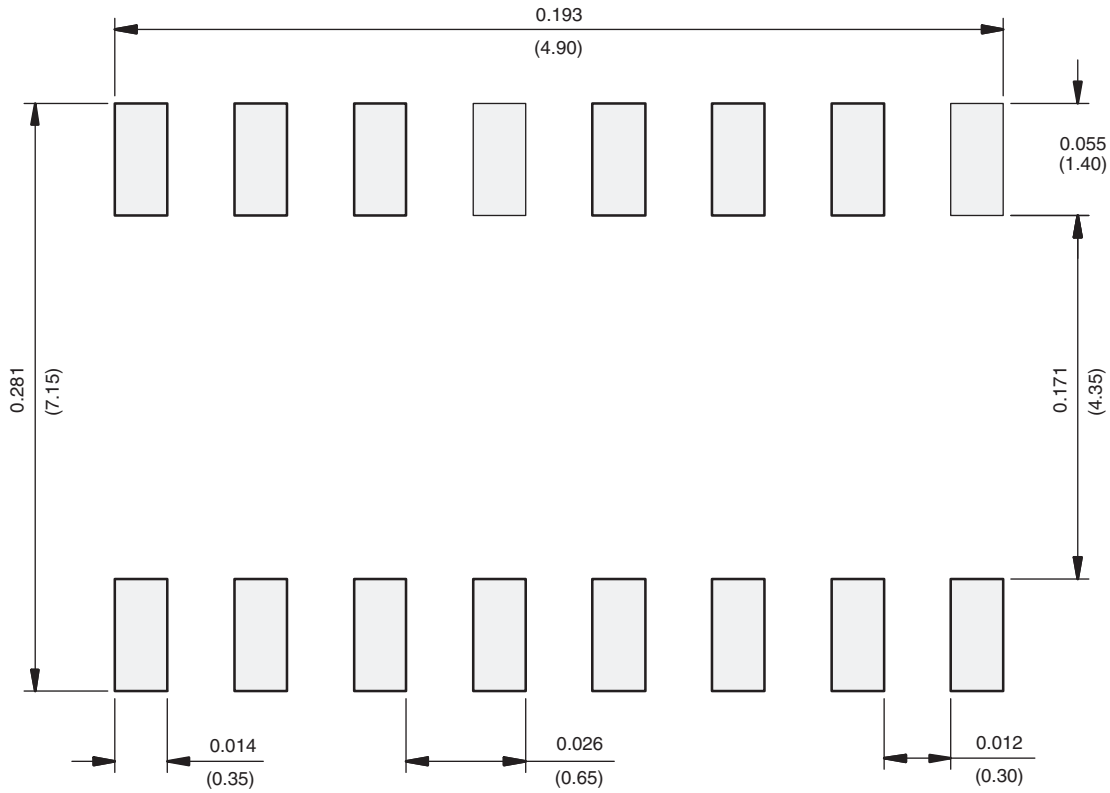

Recommended Minimum Pads  
Dimensions in inches (mm)

## RECOMMENDED MINIMUM PADS FOR SO-16



Recommended Minimum Pads  
Dimensions in Inches/(mm)

[Return to Index](#)





## Disclaimer

ALL PRODUCT, PRODUCT SPECIFICATIONS AND DATA ARE SUBJECT TO CHANGE WITHOUT NOTICE TO IMPROVE RELIABILITY, FUNCTION OR DESIGN OR OTHERWISE.

Vishay Intertechnology, Inc., its affiliates, agents, and employees, and all persons acting on its or their behalf (collectively, "Vishay"), disclaim any and all liability for any errors, inaccuracies or incompleteness contained in any datasheet or in any other disclosure relating to any product.

Vishay makes no warranty, representation or guarantee regarding the suitability of the products for any particular purpose or the continuing production of any product. To the maximum extent permitted by applicable law, Vishay disclaims (i) any and all liability arising out of the application or use of any product, (ii) any and all liability, including without limitation special, consequential or incidental damages, and (iii) any and all implied warranties, including warranties of fitness for particular purpose, non-infringement and merchantability.

Statements regarding the suitability of products for certain types of applications are based on Vishay's knowledge of typical requirements that are often placed on Vishay products in generic applications. Such statements are not binding statements about the suitability of products for a particular application. It is the customer's responsibility to validate that a particular product with the properties described in the product specification is suitable for use in a particular application. Parameters provided in datasheets and/or specifications may vary in different applications and performance may vary over time. All operating parameters, including typical parameters, must be validated for each customer application by the customer's technical experts. Product specifications do not expand or otherwise modify Vishay's terms and conditions of purchase, including but not limited to the warranty expressed therein.

Except as expressly indicated in writing, Vishay products are not designed for use in medical, life-saving, or life-sustaining applications or for any other application in which the failure of the Vishay product could result in personal injury or death. Customers using or selling Vishay products not expressly indicated for use in such applications do so at their own risk. Please contact authorized Vishay personnel to obtain written terms and conditions regarding products designed for such applications.

No license, express or implied, by estoppel or otherwise, to any intellectual property rights is granted by this document or by any conduct of Vishay. Product names and markings noted herein may be trademarks of their respective owners.

## Material Category Policy

**Vishay Intertechnology, Inc. hereby certifies that all its products that are identified as RoHS-Compliant fulfill the definitions and restrictions defined under Directive 2011/65/EU of The European Parliament and of the Council of June 8, 2011 on the restriction of the use of certain hazardous substances in electrical and electronic equipment (EEE) - recast, unless otherwise specified as non-compliant.**

**Please note that some Vishay documentation may still make reference to RoHS Directive 2002/95/EC. We confirm that all the products identified as being compliant to Directive 2002/95/EC conform to Directive 2011/65/EU.**

**Vishay Intertechnology, Inc. hereby certifies that all its products that are identified as Halogen-Free follow Halogen-Free requirements as per JEDEC JS709A standards. Please note that some Vishay documentation may still make reference to the IEC 61249-2-21 definition. We confirm that all the products identified as being compliant to IEC 61249-2-21 conform to JEDEC JS709A standards.**