





Messrs.					
Product Specification	Model:	MTF-TQ35SP741-AV	Rev. No.	Issued Date.	Page.
			C	Jan.16, 08	1 / 31

LIQUID CRYSTAL DISPLAY MODULE  
MODEL: MTF-TQ35SP741-AV  
Customer's No.:

Acceptance

*Microtips Technology Inc.*  
12F. No.31 Lane 169, Kang Ning St.,  
His-Chih, Taipei Hsien, Taiwan  
FAX: 886-2-26958625

Approved and Checked by

Approved by	Checked by		Made by
			



*Microtips Technology Inc.*

Messrs.					
Product Specification	Model:	MTF-TQ35SP741-AV	Rev. No.	Issued Date.	Page.
			C	Jan.16, 08	2 / 31

Revise Records

Rev.	Date	Contents	Written	Approved
A	2007/11/22	Initial Release	Sherry Chen	Steele Lee
B	2007/12/03	See Note 1 and 2 below.	Sherry Chen	Steele Lee
C	2008/01/16	See Note 3	Sherry Chen	Steele Lee

Special Notes

Note1.	Update Block Diagram(Page.7);
Note2.	Update the relation of SPI interface between Sync mode and DE mode.
Note3.	Update DIMENSIONAL OUTLINES (Page 31)
Note4.	
Note5.	



Messrs.					
Product Specification	Model:	MTF-TQ35SP741-AV	Rev. No.	Issued Date.	Page.
			C	Jan.16, 08	3 / 31

## Contents

<b>1. GENERAL DESCRIPTION AND FEATURES</b> .....	5
1.1 Features.....	5
1.2 General Specifications.....	5
<b>2. BLOCK DIAGRAM</b> .....	6
2.1 TFT-LCD Module (Interface System Structure) with Back Light Unit.....	6
2.2 LCM Driver IC Block.....	7
<b>3. INPUT TERMINAL PIN ASSIGNMENT</b> .....	8
3.1 CN1 Pin Assignment (LCD).....	8
3.2 Touch Panel Pin Assignment.....	10
<b>4. OPTICAL CHARACTERISTICS</b> .....	10
<b>5. ABSOLUTE MAXIMUM RATINGS</b> .....	13
5.1 Absolute Ratings of Environment.....	13
5.2 Maximum Ratings (Voltage Referenced to VSS) .....	13
<b>6. ELECTRICAL CHARACTERISTICS</b> .....	14
6.1 DC Electrical Characteristics .....	14
<b>7. AC CHARACTERISTICS</b> .....	15
7.1 Pixel timing.....	15
7.2 Data transaction timing in parallel RGB (24 bit) interface (SYNC mode).....	16
7.3 Signal timing in DE mode .....	17
<b>8. BACKLIGHT SPECIFICATIONS</b> .....	18
8.1 Absolute Maximum Ratings .....	18
8.2 Electrical/Operating Characteristics .....	18
8.3 Electrical Circuit of Backlight.....	18
<b>9. BASIC DISPLAY COLOR AND GRAY SCALE</b> .....	19
<b>10. QUALITY STANDARD FOR LCD</b> .....	20
10.1 Objective .....	20
10.2 Scope.....	20
10.3 Inspection specification.....	22
<b>11. RELIABILITY CONDITION FOR LCD</b> .....	25
11.1 LCM Reliability Test.....	25
11.2 Touch panel Reliability .....	26
<b>12. PRECAUTIONS</b> .....	27
12.1 Operation .....	27
12.2 Safety .....	27
12.3 Handling .....	27
12.4 Static electricity .....	29



Messrs.					
Product Specification	Model:	MTF-TQ35SP741-AV	Rev. No.	Issued Date.	Page.
			C	Jan.16, 08	4 / 31

12.5 Storage .....	29
12.6 Cleaning .....	29
12.7 Waste.....	29
<b>13. WARRANTY .....</b>	<b>30</b>
<b>14. DIMENSIONAL OUTLINES.....</b>	<b>30</b>



Messrs.					
Product Specification	Model:	MTF-TQ35SP741-AV	Rev. No.	Issued Date.	Page.
			C	Jan.16, 08	5 / 31

## 1. GENERAL DESCRIPTION AND FEATURES

MTF-TQ35SP741-AV is a TM (Transmissive) type color active matrix TFT (Thin Film Transistor) liquid crystal display (LCD) that uses amorphous silicon TFT devices. This model is composed of a TFT-LCD Panel, driver IC, FPC , Touch panel and a back-light unit. The resolution of a 3.5" contains 320RGBx240 dots and can display up to 16.7M colors. The following table described the features of MTF-TQ35SP741-AV.

### 1.1 Features

- Support 24-bit data (RGB).

### 1.2 General Specifications

Item	Specification	Unit	Note
Screen Size	3.5" diagonal	inch	-
Display Resolution	320 x RGB x 240	Dot	-
Dot Pitch	0.073 (W) x 0.219 (H)	mm	-
Active Area	70.08 (W) x 52.56 (H)	mm	-
Outline Dimension	77.8 (W) x 64.5 (H) x 4.12 (T), Not including FPCB	mm	-
Display Mode	Normally white/Transmissive	-	-
Pixel Arrangement	RGB-Strip	-	-
Surface Treatment	Anti-glare (AG)	-	-
weight	128	g	-
Viewing Direction	6 o'clock	-	-
Input Interface	Digital 24-bits parallel RGB	-	-
Driver IC	Himax HX8238A	-	-

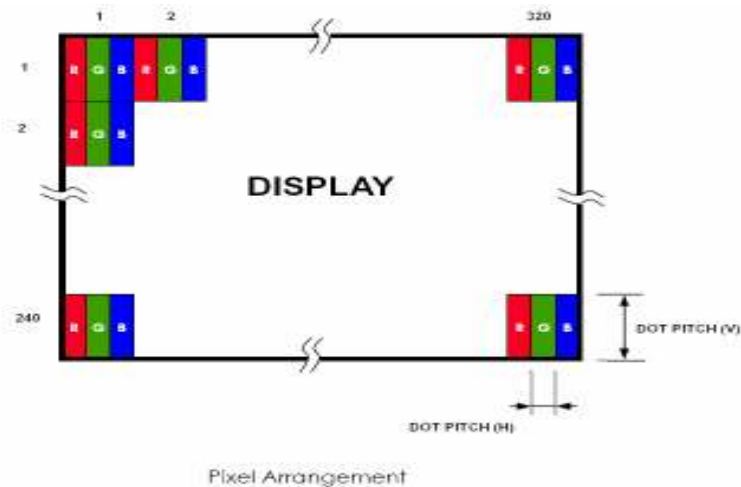

**Microtips Technology Inc.**

Messrs.					
Product Specification	Model:	MTF-TQ35SP741-AV	Rev. No.	Issued Date.	Page.
			C	Jan.16, 08	6 / 31

## 2. BLOCK DIAGRAM

### 2.1 TFT-LCD Module (Interface System Structure) with Back Light Unit

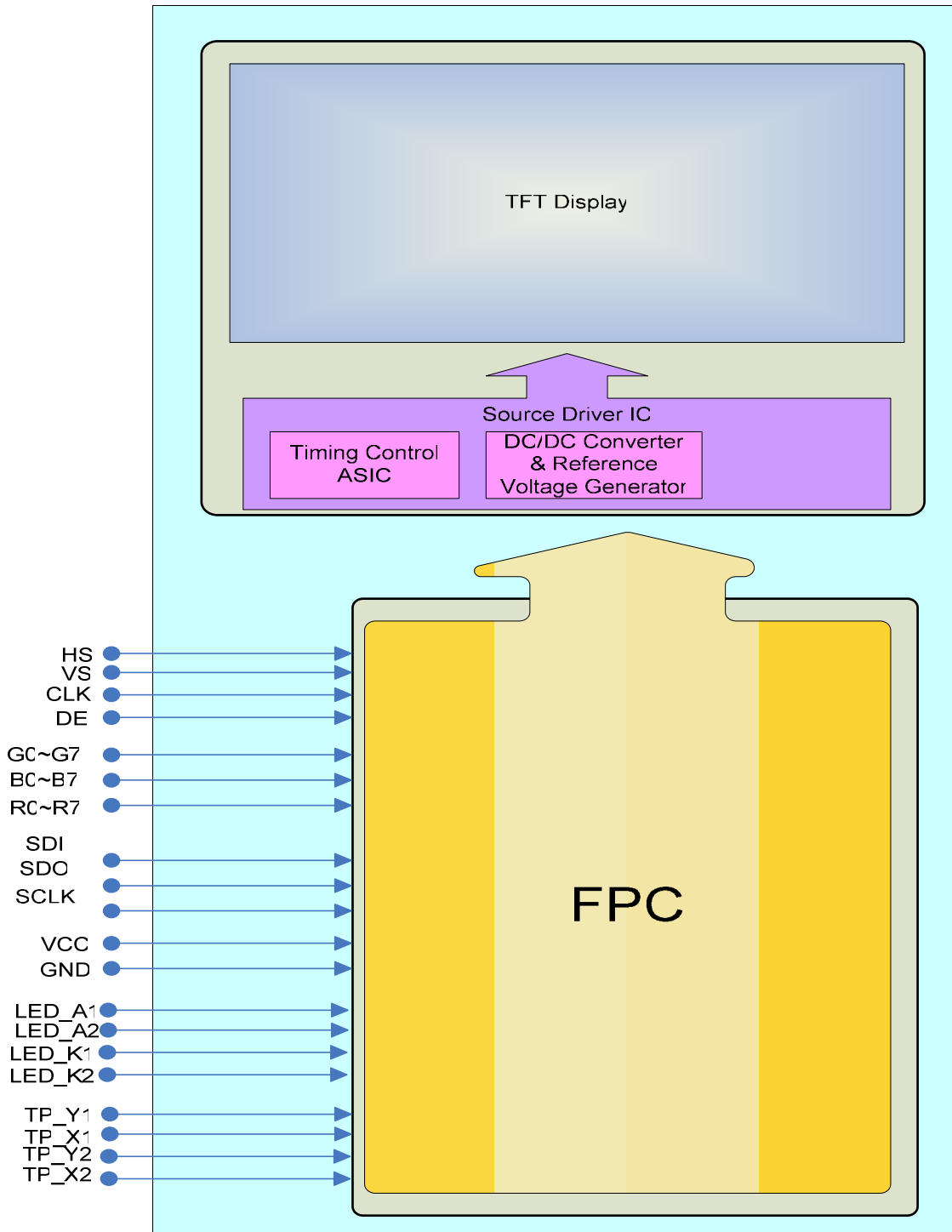

Messrs.

Product Specification	Model:	MTF-TQ35SP741-AV	Rev. No.	Issued Date.	Page.
			C	Jan.16, 08	7 / 31

## 2.2 LCM Driver IC Block

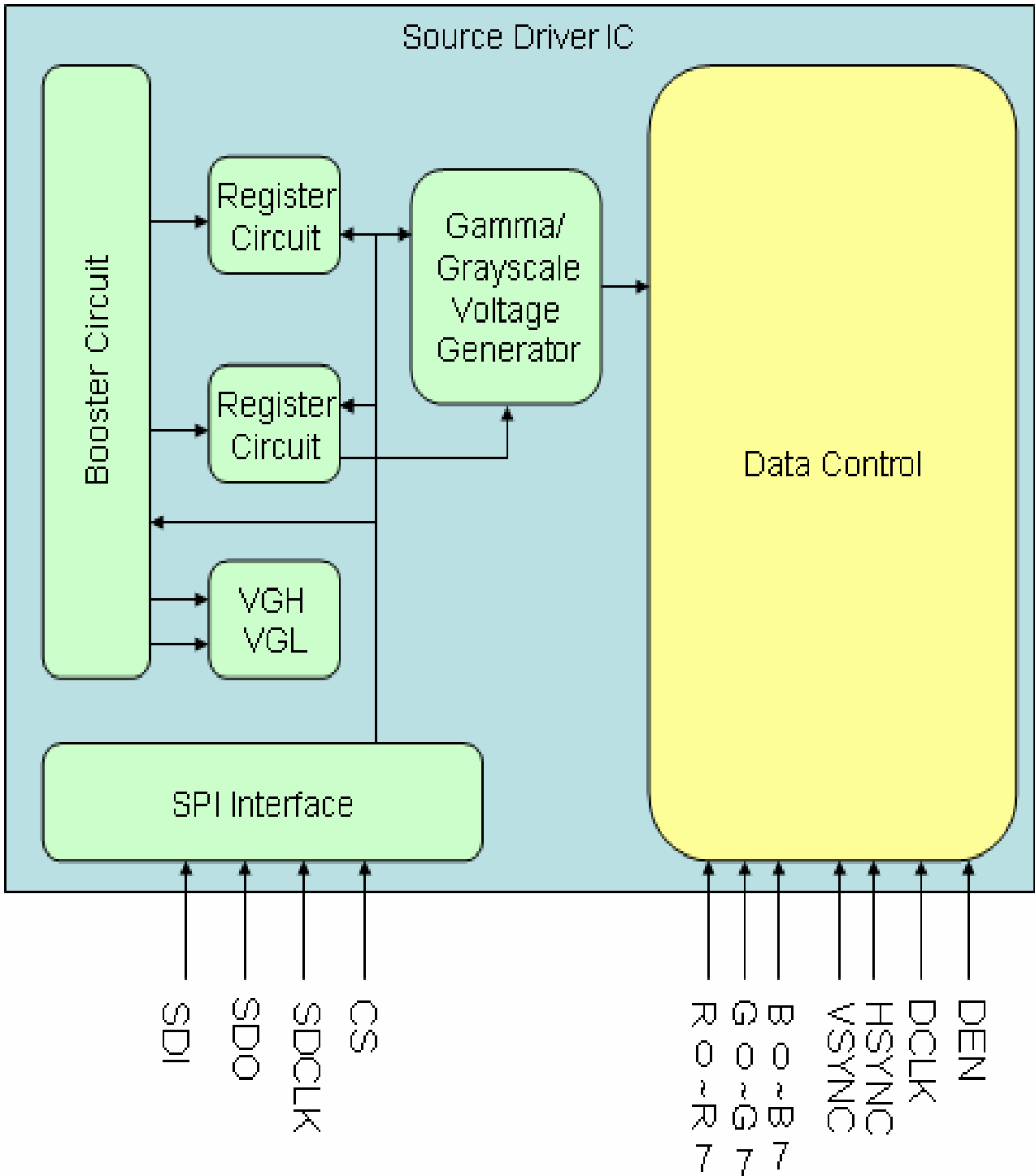

**Microtips Technology Inc.**

Messrs.					
Product Specification	Model:	MTF-TQ35SP741-AV	Rev. No.	Issued Date.	Page.
			C	Jan.16, 08	8 / 31

### 3. INPUT TERMINAL PIN ASSIGNMENT

#### 3.1 CN1 Pin Assignment (LCD)

Pin No.	Symbol	I/O	Function	Remark
1	LED K1	I	Backlight LED Ground	
2	LED K2	I	Backlight LED Ground	
3	LED A1	I	Backlight LED Power (10.2V/20mA)	
4	LED A2	I	Backlight LED Power (10.2V/20mA)	
5	N/C	-	Not Connection	
6	/REST	I	Hardware Reset	
7	N/C	-	Not Connection	
8	N/C or Y1 (Top)	I	No connection (for MTF-TQ35SN741-AV) or Y1 (Top) (for MTF-TQ35SP741-AV)	
9	N/C or X1 (Right)	I	No connection (for MTF-TQ35SN741-AV) or X1 (Right) (for MTF-TQ35SP741-AV)	
10	N/C or Y2 (Bottom)	I	No connection (for MTF-TQ35SN741-AV) or Y2 (Bottom) (for MTF-TQ35SP741-AV)	
11	N/C or X2 (Left)	I	No connection (for MTF-TQ35SN741-AV) or X2 (Left) (for MTF-TQ35SP741-AV)	
12	B0	I	Blue Data Bit 0	
13	B1	I	Blue Data Bit 1	
14	B2	I	Blue Data Bit 2	
15	B3	I	Blue Data Bit 3	
16	B4	I	Blue Data Bit 4	
17	B5	I	Blue Data Bit 5	
18	B6	I	Blue Data Bit 6	
19	B7	I	Blue Data Bit 7	
20	G0	I	Green Data Bit0	
21	G1	I	Green Data Bit1	
22	G2	I	Green Data Bit2	
23	G3	I	Green Data Bit3	
24	G4	I	Green Data Bit4	
25	G5	I	Green Data Bit5	
26	G6	I	Green Data Bit6	
27	G7	I	Green Data Bit7	





Messrs.					
Product Specification	Model:	MTF-TQ35SP741-AV	Rev. No.	Issued Date.	Page.
			C	Jan.16, 08	9 / 31

28	R0	I	Red Data Bit0	
29	R1	I	Red Data Bit1	
30	R2	I	Red Data Bit2	
31	R3	I	Red Data Bit3	
32	R4	I	Red Data Bit4	
33	R5	I	Red Data Bit5	
34	R6	I	Red Data Bit6	
35	R7	I	Red Data Bit7	
36	H <sub>SYNC</sub>	I	Horizontal Sync Input	Note 2
37	V <sub>SYNC</sub>	I	Vertical Sync Input	Note 2
38	D <sub>CLK</sub>	I	Dot Data Clock	
39	N/C	-	Not Connection	
40	N/C	-	Not Connection	
41	V <sub>CC</sub>	I	Digital Power	3.3V
42	V <sub>CC</sub>	I	Digital Power	3.3V
43	CSB	I	SPI Interface Data En Leave it open when not used!	Note 1
44	N/C	-	Not Connection	
45	N/C	-	Not Connection	
46	N/C	-	Not Connection	
47	N/C	-	Not Connection	
48	SDO	-	SPI Interface Data output Leave it open when not used!	Note 1
49	SP <sub>CLK</sub>	I	SPI Interface Data Clock Leave it open when not used!	Note 1
50	SDI	I	SPI Interface Data input Leave it open when not used!	Note 1
51	N/C	-	Not Connection	
52	DEN	I	Data Enable Input	Note 3
53	GND	I	Ground	
54	GND	I	Ground	

Note 1: SPI Interface is only to set up the initial code in LCM driver IC register.

Note 2: There had been default initial code stored in LCD driver IC at Sync Mode operation, and if customer needs to revise the default initial code to change gamma or Vcom voltage, then SPI interface is needed.

Note 3: Different from Sync mode, there is no default initial code in driver IC in DE mode, so initial code has to be setup via SPI interface at DE mode.



*Microtips Technology Inc.*

Messrs.					
Product Specification	Model:	MTF-TQ35SP741-AV	Rev. No.	Issued Date.	Page.
			C	Jan.16, 08	10 / 31

### 3.2 Touch Panel Pin Assignment

Pin No.	Designation
1	Y1 (Top)
2	X1 (RIGHT)
3	Y2 (BOTTOM)
4	X2 (LEFT)

## 4. OPTICAL CHARACTERISTICS

The following items are measured under stable conditions. The optical characteristics should be measured in a dark room or equivalent state with the methods shown in Note (1).

(Ta=25°C, Vcc = VCI=3.3V, If40mA)

Item		Symbol	Condition	Min	Type	Max	Unit	Note
Response time	Rise	T <sub>R</sub>	Viewing normal Angle $\theta_x=\theta_y=0^\circ$	--	15	30	ms	All left side data are based on CMO's following condition-T6 NTSC:60% LC:5091 Light: C light (Machine:BM5A) Normal Polarizer without DBEF Simulation Data Reference only
	Fall	T <sub>F</sub>		--	35	50	ms	
Brightness		L		160	200	--	cd/m <sup>2</sup>	
Contrast ratio		CR		200	300	--	--	
Color Chromaticity	Red	R <sub>x</sub>		--	0.591	--	--	
		R <sub>y</sub>		--	0.373	--	--	
	Green	G <sub>x</sub>		--	0.331	--	--	
		G <sub>y</sub>		--	0.599	--	--	
	Blue	B <sub>x</sub>		--	0.134	--	--	
		B <sub>y</sub>		--	0.171	--	--	
White	W <sub>x</sub>	--	0.295	--	--			
	W <sub>y</sub>	--	0.311	--	--			
Viewing Angle	Hor.	$\theta_{x+}$	Center CR≥10	50	60	--	Degree	
		$\theta_{x-}$		50	60	--		
	Ver.	$\theta_{y+}$		40	50	--		
		$\theta_{y-}$		50	60	--		

Note 1: Definition of Contrast Ratio (CR):

The contrast ratio can be calculated by the following expression.

Contrast Ratio (CR)= L63/L0

L63: Luminance of gray level 63

L0: Luminance of gray level 0

CR=CR (10)

CR(X) is corresponding to the Contrast Ratio of the point X at Figure in Note (5)



**Microtips Technology Inc.**

Messrs.					
Product Specification	Model:	MTF-TQ35SP741-AV	Rev. No.	Issued Date.	Page.
			C	Jan.16, 08	11 / 31

Note 2: Definition of Response Time ( $T_R$   $T_F$ ):

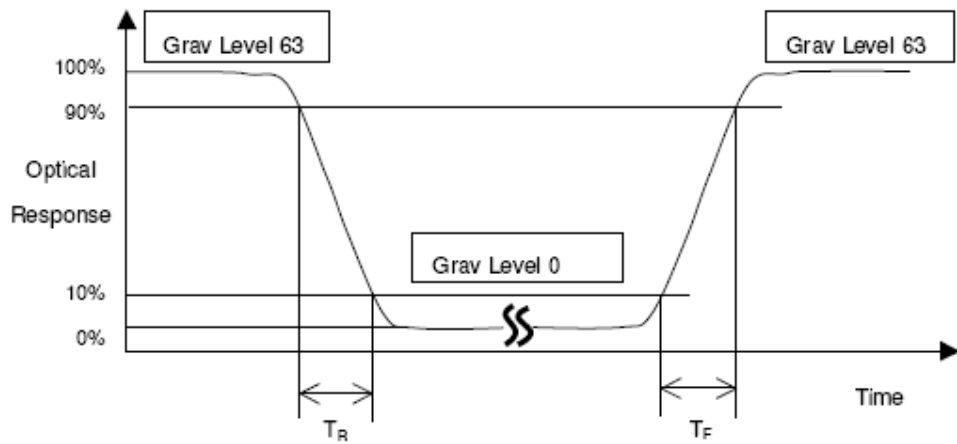

Note 3: Definition of Viewing Angle

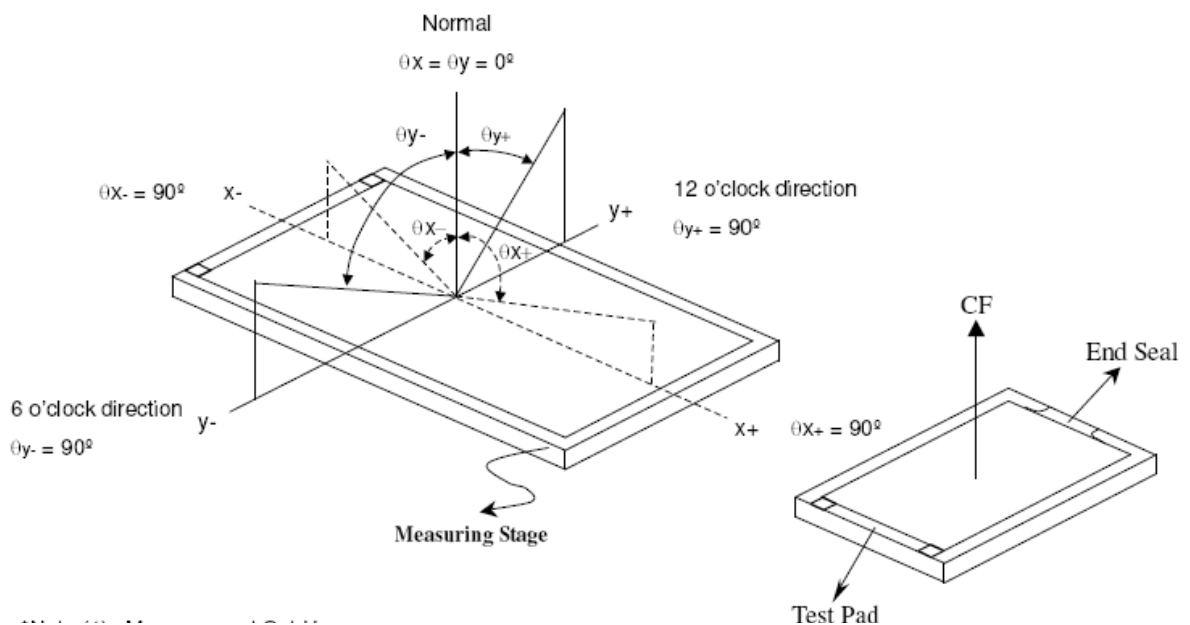

**Microtips Technology Inc.**

Messrs.					
Product Specification	Model:	MTF-TQ35SP741-AV	Rev. No.	Issued Date.	Page.
			C	Jan.16, 08	12 / 31

(4) Measurement Set-Up:

The LCD module should be stabilized at a given temperature for 20 minutes to avoid abrupt temperature change during measuring. In order to stabilize the luminance, the measurement should be executed after lighting Backlight for 20 minutes in a windless room.

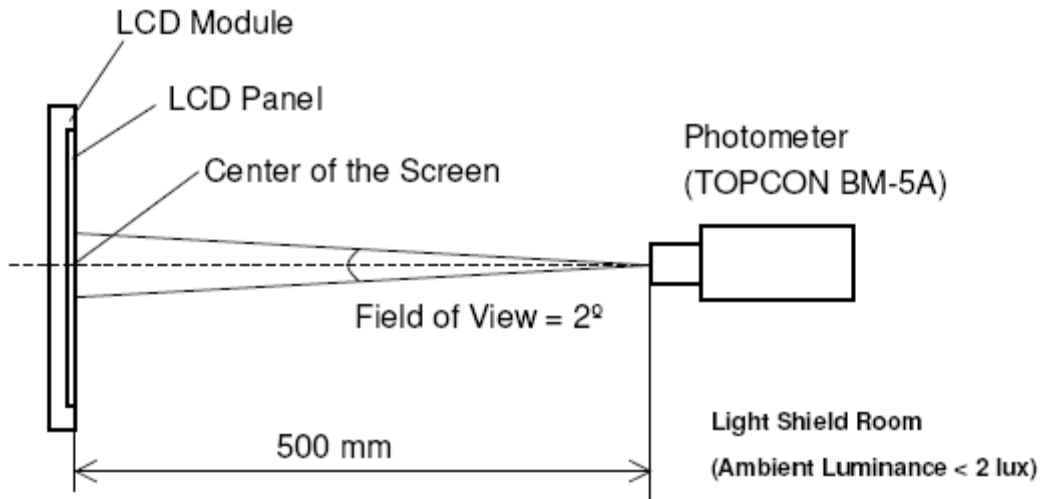

(5) Measurement Set-Up:

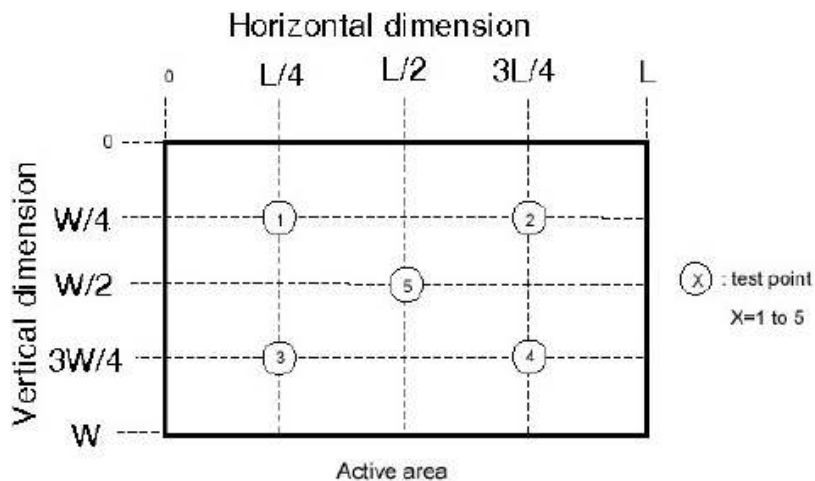

Messrs.					
Product Specification	Model:	MTF-TQ35SP741-AV	Rev. No.	Issued Date.	Page.
			C	Jan.16, 08	13 / 31

## 5. ABSOLUTE MAXIMUM RATINGS

### 5.1 Absolute Ratings of Environment

If the operating condition exceeds the following absolute maximum ratings, the TFT LCD module may be damaged permanently.

(Ta=25(2°C, VSS=GND=0)

Item	Symbol	Min.	Max.	Unit	Note
Storage temperature	TSTG	-30	80	°C	(1)
Operating temperature (Ambient temperature)	TOPR	-20	70	°C	(1), (2)

Note (1) 95 % RH Max. ( 40 °C ≥ Ta )

Maximum wet-bulb temperature at 39 °C or less. (Ta > 40 °C) No condensation.

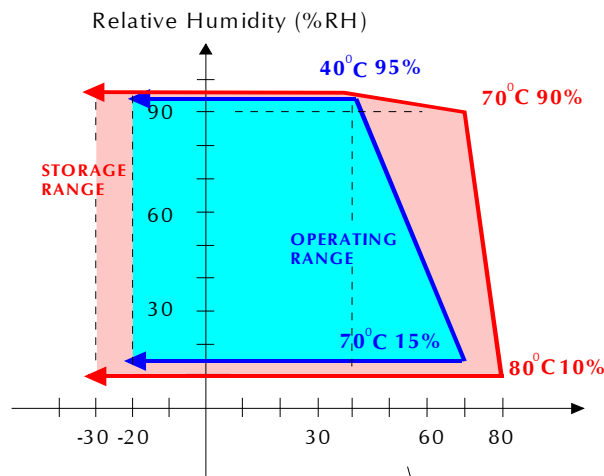

(2) In case of below 0°, the response time of liquid crystal (LC) becomes slower and the color of panel becomes darker than normal one. Level of retardation depends on temperature, because of LC's character

### 5.2 Maximum Ratings (Voltage Referenced to VSS)

Item	Symbol	Condition	Min.	Max.	Unit	Remark
Power voltage	VCC	VSS=0	-0.3	6.0	V	
Input voltage	V <sub>in</sub>		-0.3	VCC+0.3	V	Note 1

Note1:Hsync, Vsync, DEN, DCLK, R0~R7, G0~G7, B0~B7



**Microtips Technology Inc.**

Messrs.					
Product Specification	Model:	MTF-TQ35SP741-AV	Rev. No.	Issued Date.	Page.
			C	Jan.16, 08	14 / 31

## 6. ELECTRICAL CHARACTERISTICS

### 6.1 DC Electrical Characteristics

(Unless otherwise specified, Voltage Referenced to Vss, VCC=3.3V, Ta=25°C)

Item		Symbol	Value			Unit	
			Min.	Typ.	Max.		
Power supply		VCC	3.0	3.3	3.6	V	
Input Voltage for logic	H Level	$V_{IH}$	0.7 VCC	-	VCC	V	Note 1
	L Level	$V_{IL}$	0	-	0.3 VCC	V	
Power Supply current		ICC	-	34.36	-	mA	Note 2

Note1: Hsync, Vsync, DEN, DCLK, R0~R7, G0~G7, B0~B7

Note2: fV =60Hz , Ta=25°C , Display pattern : All Black



*Microtips Technology Inc.*

Messrs.					
Product Specification	Model:	MTF-TQ35SP741-AV	Rev. No.	Issued Date.	Page.
			C	Jan.16, 08	15 / 31

## 7. AC CHARACTERISTICS

### 7.1 Pixel timing

(Unless otherwise specified, Voltage Referenced to  $V_{SS}$ ,  $V_{CCIO}=3.3V$ ,  $T_a=25^\circ C$ )

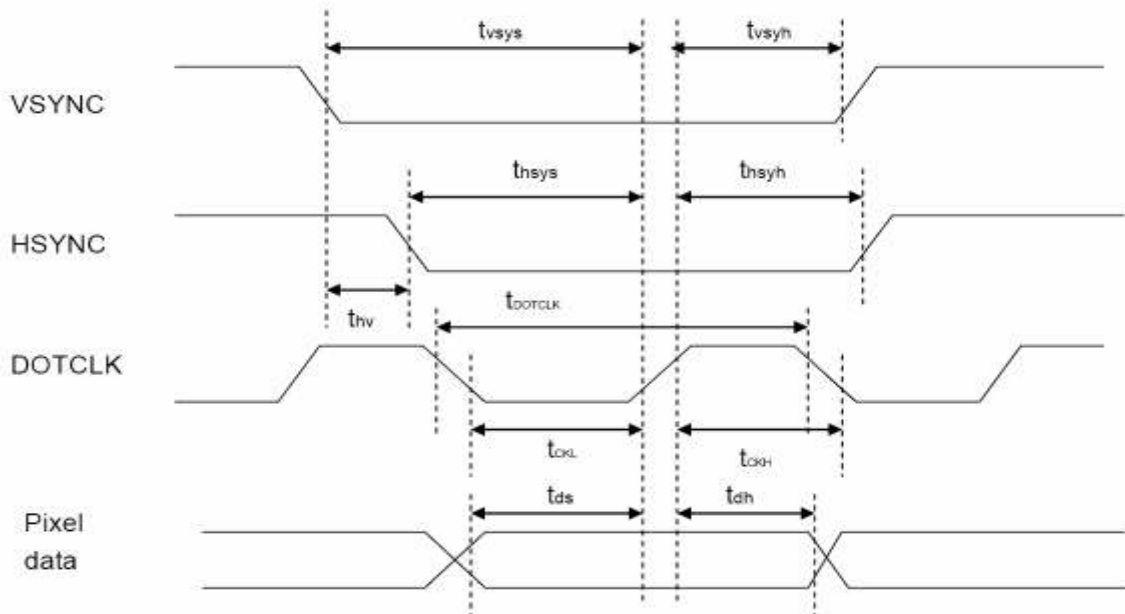

PARAMETER	Symbol	Min.		Typ.		Max.		Unit
		24 bit	8 bit	24 bit	8 bit	24 bit	8 bit	
DOTCLK Frequency	fDOTCLK	-	-	6.5	19.5	10	30	MHz
DOTCLK Period	tDOTCLK	100	33.3	154	51.3	-	-	ns
Vertical Sync Setup Time	tvsys	20	10	-	-	-	-	ns
Vertical Sync Hold Time	tvsyh	20	10	-	-	-	-	ns
Horizontal Sync Setup Time	thsys	20	10	-	-	-	-	ns
Horizontal Sync Hold Time	thsyh	20	10	-	-	-	-	ns
Phase difference of Sync Signal Falling Edge	thv	1		-		240		tDOTCLK
DOTCLK Low Period	tCKL	50	15	-	-	-	-	ns
DOTCLK High Period	tCKH	50	15	-	-	-	-	ns
Data Setup Time	tds	12	10	-	-	-	-	ns
Data hold Time	tdh	12	10	-	-	-	-	ns
Reset Pulse Width	tRES	10		-	-	-	-	us

Note: External clock source must be provided to DOTCLK pin of HX8238-A. The driver will not operate if absent of the clocking signal.



**Microtips Technology Inc.**

Messrs.

Product Specification	Model:	MTF-TQ35SP741-AV	Rev. No.	Issued Date.	Page.
			C	Jan.16, 08	16 / 31

7.2 Data transaction timing in parallel RGB (24 bit) interface (SYNC mode)

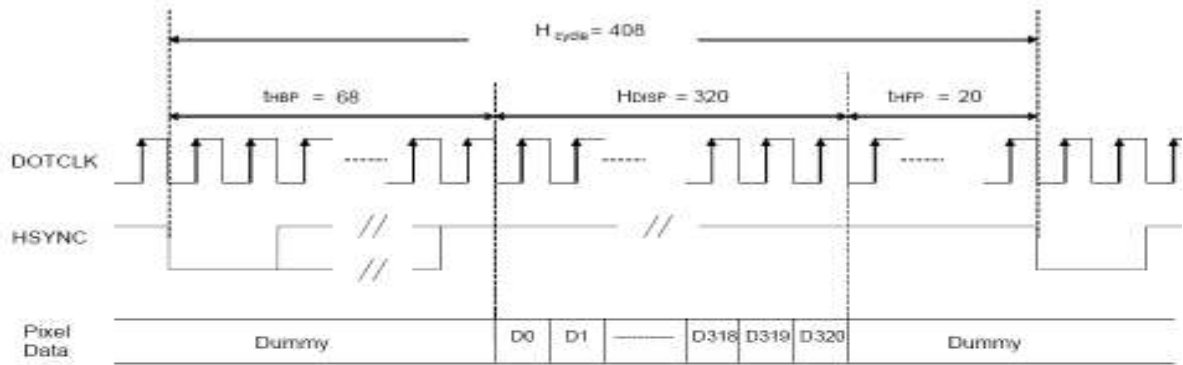

a) Horizontal Data Transaction Timing

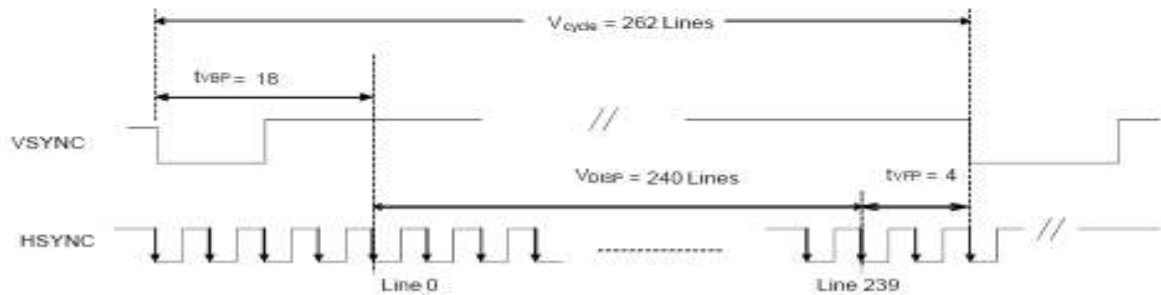

b) Vertical Data Transaction Timing

**Data transaction timing in parallel RGB (24 bit) interface (SYNC mode)**

PARAMETER	Symbol	Min.		Typ.		Max.		Unit
		24 bit	8 bit	24 bit	8 bit	24 bit	8 bit	
DOTCLK Frequency	fDOTCLK	-	-	6.5	19.5	10	30	MHz
DOTCLK Period	tDOTCL	100	33.3	154	51.3	-	-	Ns
Horizontal Frequency (Line)	fH	-		14.9		22.35		KHz
Vertical Frequency (Refresh)	fV	-		60		90		Hz
Horizontal Back Porch	tHBP	-	-	68	204	-	-	tDOTCLK
Horizontal Front Porch	tHFP	-	-	20	60	-	-	tDOTCLK
Horizontal Data Start Point	tHBP	-	-	68	204	-	-	tDOTCLK
Horizontal Blanking Period	tHBP+tHFP	-	-	88	264	-	-	tDOTCLK
Horizontal Display Area	HDISP	-	-	320	960	-	-	tDOTCLK
Horizontal Cycle	Hcycle	-	-	408	1224	450	1350	tDOTCLK



*Microtips Technology Inc.*



Messrs.					
Product Specification	Model:	MTF-TQ35SP741-AV	Rev. No.	Issued Date.	Page.
			C	Jan.16, 08	17 / 31

### 7.3 Signal timing in DE mode

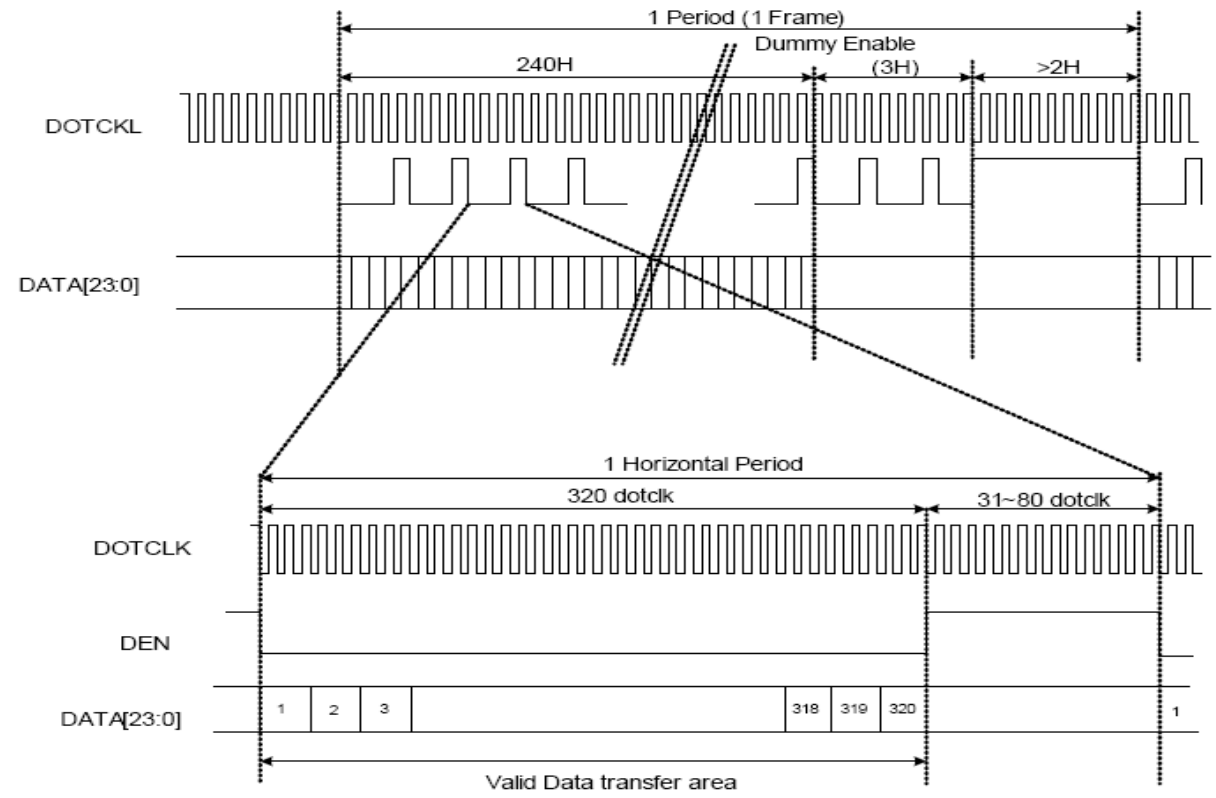

Messrs.					
Product Specification	Model:	MTF-TQ35SP741-AV	Rev. No.	Issued Date.	Page.
			C	Jan.16, 08	18 / 31

## 8. BACKLIGHT SPECIFICATIONS

### 8.1 Absolute Maximum Ratings

Ta = 25°C

Parameter	Symbol	Maximun Rating	Units
Peak Forward Current	I <sub>FM</sub>	40	mA
Reverse Voltage	V <sub>R</sub>	20	V
Power Dissipation	Pd	456	mW
Operating Temperature	T <sub>OPR</sub>	-20~+70	°C
Storage Temperature	T <sub>STG</sub>	-30~+80	°C

### 8.2 Electrical/Operating Characteristics

Ta = 25°C

Parameter	Symbol	Min.	Typ.	Max.	Units	Test Condition
Forward Voltage(VLED1\VLED2)	V <sub>F</sub>	9.0	10.2	11.4	V	Ta=25°C IF=40mA
LED (1+2) Current	I <sub>L</sub>	-	20+20	-	mA	
Uniformity	-	75	-	-	%	
Chromaticity Coordinates	X	0.27	0.30	0.32	-	
	Y	0.27	0.31	0.33	-	

\*Uniformity = (Min./Max.) x 100%

### 8.3 Electrical Circuit of Backlight

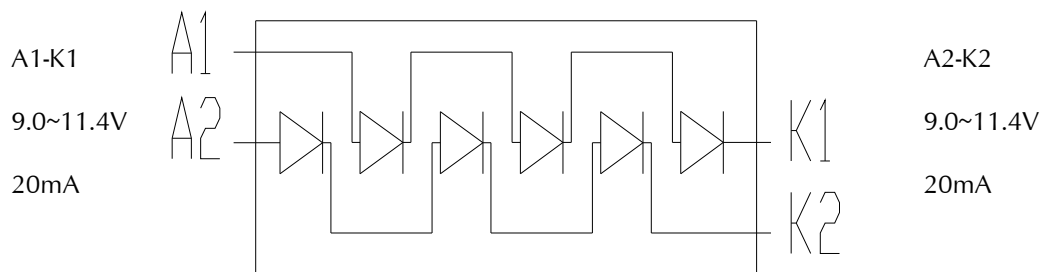

**Microtips Technology Inc.**

Messrs.					
Product Specification	Model:	MTF-TQ35SP741-AV	Rev. No.	Issued Date.	Page.
			C	Jan.16, 08	19 / 31

## 9. BASIC DISPLAY COLOR AND GRAY SCALE

Color		Input Color Data																							
		Red								Green								Blue							
		MSB				LSB				MSB				LSB				MSB				LSB			
		R7	R6	R5	R4	R3	R2	R1	R0	G7	G6	G5	G4	G3	G2	G1	G0	B7	B6	B5	B4	B3	B2	B1	B0
Basic Colors	Black	0	0	0	0	0	0	0	0	0	0	0	0	0	0	0	0	0	0	0	0	0	0	0	0
	Red(255)	1	1	1	1	1	1	1	1	0	0	0	0	0	0	0	0	0	0	0	0	0	0	0	0
	Green(255)	0	0	0	0	0	0	0	0	1	1	1	1	1	1	1	1	0	0	0	0	0	0	0	0
	Blue(255)	0	0	0	0	0	0	0	0	0	0	0	0	0	0	0	0	1	1	1	1	1	1	1	1
	Cyan	0	0	0	0	0	0	0	0	1	1	1	1	1	1	1	1	1	1	1	1	1	1	1	1
	Magenta	1	1	1	1	1	1	1	1	0	0	0	0	0	0	0	0	1	1	1	1	1	1	1	1
	Yellow	1	1	1	1	1	1	1	1	1	1	1	1	1	1	1	1	0	0	0	0	0	0	0	0
	White	1	1	1	1	1	1	1	1	1	1	1	1	1	1	1	1	1	1	1	1	1	1	1	1
Red	Red(0) Dark	0	0	0	0	0	0	0	0	0	0	0	0	0	0	0	0	0	0	0	0	0	0	0	0
	Red(1)	0	0	0	0	0	0	0	1	0	0	0	0	0	0	0	0	0	0	0	0	0	0	0	0
	Red(2)	0	0	0	0	0	0	1	0	0	0	0	0	0	0	0	0	0	0	0	0	0	0	0	0
	:	:	:	:	:	:	:	:	:	:	:	:	:	:	:	:	:	:	:	:	:	:	:	:	:
	Red(253)	1	1	1	1	1	1	0	1	0	0	0	0	0	0	0	0	0	0	0	0	0	0	0	0
	Red(254)	1	1	1	1	1	1	1	0	0	0	0	0	0	0	0	0	0	0	0	0	0	0	0	0
	Red(255) Bright	1	1	1	1	1	1	1	1	0	0	0	0	0	0	0	0	0	0	0	0	0	0	0	0
Green	Green(0) Dark	0	0	0	0	0	0	0	0	0	0	0	0	0	0	0	0	0	0	0	0	0	0	0	0
	Green(1)	0	0	0	0	0	0	0	0	0	0	0	0	0	0	0	1	0	0	0	0	0	0	0	0
	Green(2)	0	0	0	0	0	0	0	0	0	0	0	0	0	0	1	0	0	0	0	0	0	0	0	0
	:	:	:	:	:	:	:	:	:	:	:	:	:	:	:	:	:	:	:	:	:	:	:	:	
	Green(253)	0	0	0	0	0	0	0	0	1	1	1	1	1	1	0	1	0	0	0	0	0	0	0	0
	Green(254)	0	0	0	0	0	0	0	0	1	1	1	1	1	1	1	0	0	0	0	0	0	0	0	0
	Green(255) Bright	0	0	0	0	0	0	0	0	1	1	1	1	1	1	1	1	0	0	0	0	0	0	0	0
Blue	Blue(0) Dark	0	0	0	0	0	0	0	0	0	0	0	0	0	0	0	0	0	0	0	0	0	0	0	0
	Blue(1)	0	0	0	0	0	0	0	0	0	0	0	0	0	0	0	0	0	0	0	0	0	0	0	1
	Blue(2)	0	0	0	0	0	0	0	0	0	0	0	0	0	0	0	0	0	0	0	0	0	0	1	0
	:	:	:	:	:	:	:	:	:	:	:	:	:	:	:	:	:	:	:	:	:	:	:	:	
	Blue(253)	0	0	0	0	0	0	0	0	0	0	0	0	0	0	0	0	1	1	1	1	1	1	0	1
	Blue(254)	0	0	0	0	0	0	0	0	0	0	0	0	0	0	0	0	1	1	1	1	1	1	1	0
	Blue(255) Bright	0	0	0	0	0	0	0	0	0	0	0	0	0	0	0	0	1	1	1	1	1	1	1	1



Messrs.					
Product Specification	Model:	MTF-TQ35SP741-AV	Rev. No.	Issued Date.	Page.
			C	Jan.16, 08	20 / 31

## 10. QUALITY STANDARD FOR LCD

### 10.1 Objective

This specification book is the standard for LCD module general inspection. And also this book will be refer to customer approval specification.

### 10.2 Scope

This specification book is applicable to general LCD module. If supplier has any doubt or requirement, then it can be discussed.

#### 10.2.1 Acceptable Quality Level

INSPECTION	SAMPLING PROCEDURES	A.Q.L
Major	MIL-STD-105E Inspection Level II Normal Inspection Single sample inspection	1
Minor	MIL-STD-105E Inspection Level II Normal Inspection Single sample inspection	1.5

#### Major defect :

A major defect is a defect that could result in failure or extremely reduction on the usability of the product for its intended purpose.

#### Minor defect :

A minor defect is one that does not materially reduce the usability of the product for its intended purpose or is a departure from established standards giving no significant bearing on the effective use or operation of the unit.

#### 10.2.2 Inspection Conditions

##### 10.2.2.1 The environmental conditions for inspection shall be as follows

- Room Temperature : 25±10°C
- Humidity Temperature : 45±20%RH

##### 10.2.3 The external visual inspection

- The inspection shall be performed by using 40Watts fluorescent lamp for illumination and the distance between LCD and eyes of the inspector shall be 30cm or more.



Messrs.					
Product Specification	Model:	MTF-TQ35SP741-AV	Rev. No.	Issued Date.	Page.
			C	Jan.16, 08	21 / 31

#### 10.2.4 Inspection Item

Pinhole, Bright spot, Black spot, White spot, Black line, White Line, Foreign particle, Bubble	The color of a small area is different from the remainder. The phenomenon dose not change with voltage.
Contrast variation	The color of a small area is different from the remainder. The phenomenon change with voltage.
Glass defect	Glass crack, Chip
Operating	Function, Contrast, Uniformity, Components

#### 10.2.5 Definition of the Area

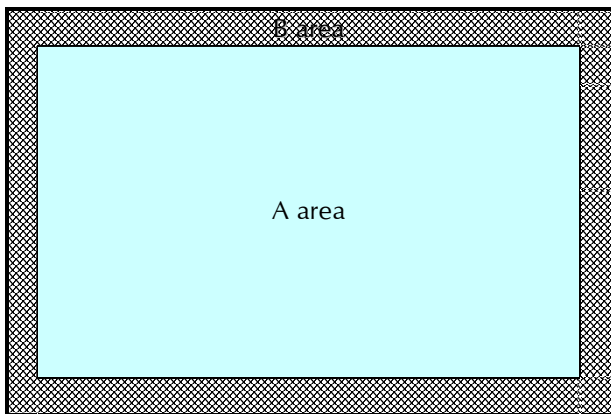

A area: Viewing Area  
 B area: Out of Viewing Area



Messrs.					
Product Specification	Model:	MTF-TQ35SP741-AV	Rev. No.	Issued Date.	Page.
			C	Jan.16, 08	22 / 31

### 10.3 Inspection specification

#### 10.3.1 Non-operating inspection specification

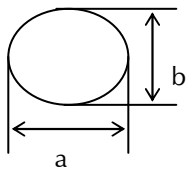
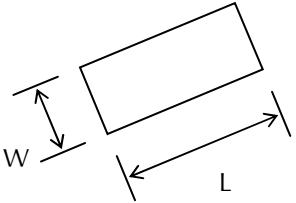
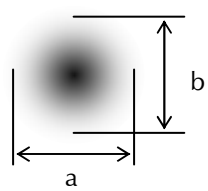
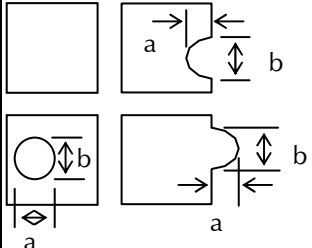
Class of defects	No.	Inspection Item	Criteria of defects		Acceptable Q'ty		
					Zone A	Zone B	
Major	1	Circuits	1. Circuit short		0	0	
			2. Circuit open				
Minor	2	Black spot, White spot, Bright spot, Foreign particle  $\phi = (a+b)/2$	A	$\phi \leq 0.1$	*	Ignore	
			B	$0.1 < \phi < 0.2$	3		
			C	$0.2 \leq \phi < 0.3$	1		
			D	$0.3 \leq \phi$	0		
			Total defect point (B,C)		3		
			* Reject when 5 or more spots are gathered within 5mm circle.				
	3	Black line, White line 	A	$W \leq 0.02$	-	*	Ignore
			B	$0.02 < W \leq 0.05$	$L \leq 5$	2	
			C	$0.05 < W \leq 0.1$	$L \leq 3$	2	
			D	$0.1 < W$	-	0	
Total defect point (B,C)			3				
* Reject when 5 or more spots are gathered within 5mm circle.							
4	Contrast variation  $\phi = (a+b)/2$	A	$\phi \leq 0.3$	Ignore	Ignore		
		B	$0.3 < \phi \leq 0.4$	2			
		C	$0.4 < \phi \leq 0.5$	1			
		D	$0.5 < \phi$	0			
		Total defect point (B,C)		3			
5	Pattern deformity  $\phi = (a+b)/2$	1. Pin hole		Ignore			
		A	$\phi \leq 0.15$		Ignore		
		B	$0.15 < \phi \leq 0.2$		2 (*)		
			$0.2 < \phi$		0		
		* Two pin hole shall not formed in the single dot					
		2. Excess, void					
A	$a \leq 0.2$ and $b \leq 0.2$	Ignore	Ignore				
B	$0.2 < a$ or $0.2 < b$	0					



Messrs.					
Product Specification	Model:	MTF-TQ35SP741-AV	Rev. No.	Issued Date.	Page.
			C	Jan.16, 08	23 / 31

Minor	6	Dot defect	A	Bright dot	$N \leq 2$	Ignore
			B	Dark dot	$N \leq 3$	
			C	Total defect dot	$N \leq 4$	
			* This inspection item does not apply to B/W LCD			
	7	Bubble between Polarizer and panel	A	$\phi \leq 0.3$	Ignore	Ignore
			B	$0.3 < \phi \leq 0.5$	2	
			C	$0.5 < \phi$	0	
	8	Polarizer scratch and particle	Circular : Same as inspection item No.2			Ignore
			Linear : Same as inspection item No.3			
	9	Polarizer Dent	A	$\phi \leq 0.2$	Ignore	Ignore
			B	$0.2 < \phi \leq 0.3$	2	
			C	$0.3 < \phi \leq 0.4$	1	
			D	$0.4 < \phi$	0	
			Total defect point (B,C)			3
	10	Bubble in the Cell	Any size		0	0
11	Dirt on polarizer	Dirt which can be wiped easily should be accepted.				
12	Protection film	The protection film should not be stripped up to viewing area and the peeled off angle should not exceed 20 degrees.				
13	Polarizer shift	1. Shifting in position should not exceed the glass outline dimension. 2. Incomplete covering of the viewing area due to shifting is not allowed. 3. Shifting in position should be within the tolerance (refer to module dimensional drawing)				
14	Silicon	1. Silicon must cover all circuits. 2. Silicon thickness should be within specification (refer to module dimensional drawing)				
15	Tape	1. Location: refer to specification. 2. Insufficient adhesive.				
Major	16	TCP, FPC defect	Film or Pattern should not have crack.			
	17	Components	Missing components not allowed.			

\* Condition of item 2~9

- Distance between defects must be more than 10mm with light on, more than 15mm with light off.
- Total acceptable defect number
  - Defects with light on : 6 points



**Microtips Technology Inc.**

Messrs.					
Product Specification	Model:	MTF-TQ35SP741-AV	Rev. No.	Issued Date.	Page.
			C	Jan.16, 08	24 / 31

Class of defects	No.	Inspection Item	Criteria of defects
Major	1	No display	--
	2	Abnormal operation	--
	3	Contrast defect	Judge according to module specification. Establish boundary sample if required.
	4	Viewing angle defect	Judge according to module specification. Establish boundary sample if required.
	5	Excess power consumption	Judge according to module specification.
	6	Back-light, LED defect	1. No lit-on 2. Different color 3. Low brightness
	7	Speaker, Vibrator defect	1. No operation 2. Abnormal operation
Minor	8	Cross-talk defect	No noticeable crosstalk. Establish boundary sample if required.
	9	Uneven brightness	No noticeable unevenness allowed. Establish boundary sample if required.
	10	Uneven color	No noticeable unevenness allowed. Establish boundary sample if required.
	11	Spot, Pinhole, Foreign particle, Line	Same as in Chapter 7.1





Messrs.					
Product Specification	Model:	MTF-TQ35SP741-AV	Rev. No.	Issued Date.	Page.
			C	Jan.16, 08	25 / 31

## 11. RELIABILITY CONDITION

### 11.1 LCM Reliability Test

#### 11.1.1 Reliability Test Condition

No.	TFT	Item	Condition	Test time	Note
1	V	High temp. operating	70°C	240 Hrs	-
2	V	Low temp. operating	-20°C	240 Hrs	-
3	V	High temp. storage	80°C	240 Hrs	-
4	V	Low temp. storage	-30°C	240 Hrs	-
5	V	High Temp / High Humidity Storage	T = 60°C /90%. For (But no condensation dew)	240 Hrs	-
6	V	High Temp/ High Humidity Operating	T = 40°C /90% For (But no condensation dew)	240 Hrs	-
7	V	Thermal Shock	-30°C → +25°C → +80°C, 50 cycle 30min 5min 30min	-	-

#### 11.1.2 Operating Test Pattern

No.	Items	Test Pattern
1	Test Pattern in Driving Condition	1. Full Red 2. Full Green 3. Full Blue 4. Gradation (horizontal) 5. Gradation (vertical) 6. Character (111111) 7. Full White 8. Full Black 9. Black Line (horizontal) 10. Black Line (vertical) 11. Mosaic (1X1) The Test Pattern is changed 1sec. The same Pattern are repeated.
2	Black Square	Black Window and White Background



Messrs.					
Product Specification	Model:	MTF-TQ35SP741-AV	Rev. No.	Issued Date.	Page.
			C	Jan.16, 08	26 / 31

### 11.1.3 Test Method

The method of visual inspection is equal to the appearance standard. Evaluation and assessment made two hours after return to room temperature ( $25 \pm 5^{\circ}\text{C}$ ). The LCDs subjected to the test must not have dew condensation.

The test pattern is gray scale and the operating voltage sweep from  $V_{th}$  to  $V_{sat}$  variable.

The non-uniformity and other appearance are checked in LCD.

### 11.1.4 Result Evaluation Criteria

There should be no change which might affect the practical display function when the display quality test is conducted under normal operating condition.

### 11.1.5 Life time

Life time expectancy of LCD Panel is approximately 50,000 hours under the room environment. Definition on the termination of life time is deterioration of contrast ratio by one fifth against initial value.

### 11.1.6 Basic rule for Reliability test

- \* Place all the samples under room temperature & humidity for 24 hours after reliability stressing.
- \* Room environment means  $25 \pm 10^{\circ}\text{C}$ ,  $45 \pm 20\% \text{RH}$
- \* There should be no condensation during the test.
- \* One LCD module shall be used for one test item only and once.

### 11.1.7 Judgment Criteria for reliability test No. 1-2

- \* Contrast (or Brightness) ratio variation is within 50% of the initial value.
- \* No abnormal function
- \* No extreme decay on appearance

### 11.1.8 Life time

Display (LCD module) : Life time expectancy of LCD Panel is approximately 50,000 hours under the room environment.

## 11.2 Touch panel Reliability

No.	Items	Min.	Typ.	Max.	Unit	Remark
1	Activation Force	100	130	150	g	1. within active area. 2. R8.0mm polyacetal pen or finger.
2	Surface Hardness	3	-	-	H	Judgment ref. JIS-K5600
3	Durability (Writing Life)	100,000	-	-	characters	1. within active area. 2. R0.8mm polyacetal pen. 3. Load: 150g 4. Speed: 60mm/sec
4	Durability (Hitting Life)	1,000,000	-	-	touches	1. within active area. 2. R0.8mm polyacetal pen. 3. Load: 250g 4. Frequency: 3 times/sec



Messrs.					
Product Specification	Model:	MTF-TQ35SP741-AV	Rev. No.	Issued Date.	Page.
			C	Jan.16, 08	27 / 31

## 12. PRECAUTIONS





### 12.1 Operation

Burn-in sometimes happens when the same character was displayed at along time. Therefore, to prevent Burn-in, it is recommended to set up a Screen-saver function.

### 12.2 Safety

The liquid crystal in the LCD is poisonous, DO NOT put it in your mouth. If the liquid crystal touches your skin or clothes, wash it off immediately using soap and water.







### 12.3 Handling

	<p>a. The LCD module shall be installed flat, without twisting or bending.  b. COF or FPC has narrow pattern width, so easily become open circuit by external force. DO NOT apply pressure to COF or FPC especially in bending area.</p>
	<p>c. To avoid damage in appearance or malfunction, DO NOT subject the module to mechanical shock or to excessive force on its surface.</p>
	<p>d. The polarizer attached to the display is very easy to damage, handle it with care to avoid scratching.</p>
	<p>e. To avoid contamination on the display surface, DO NOT touch the display surface with bare hands.  f. Provide a space so that the LCD module does not come into contact with other components.</p>



Messrs.

Product Specification	Model:	MTF-TQ35SP741-AV	Rev. No.	Issued Date.	Page.
			C	Jan.16, 08	28 / 31

	<p>g. To protect the LCD panel from external pressure, put covering glass (acrylic board or similar board) to keep appropriate space between them.</p>
	<p>h. Be careful for condensation at sudden temperature change. Condensation makes damage to polarizer or electrical contacted parts. And after fading condensation, smear or spot will occur.</p>
	<p>i. Property of semiconductor devices may be affected when they are exposed to light possibly resulting in malfunctioning of the ICs. To prevent such malfunctioning of the ICs, your design and mounting layout done are so that the IC is not exposed to light in actual use.</p>
	<p>j. Strong light exposure causes degradation of color filter. It may not recover</p>
	<p>k. DO NOT contact with water to avoid Metal corrosion.</p> <p>l. When it is not in use, the screen must be turned off or the pattern must be frequently changed by a screen saver. If it displays the same pattern for a long period of time, brightness down/image sticking may develop due to the LCD structure.</p>
	<p>m. Never disassemble LCD product under any circumstances. If unqualified operators or users assemble the product after disassembling it, it may not function or its operation may be seriously affected.</p>



Messrs.					
Product Specification	Model:	MTF-TQ35SP741-AV	Rev. No.	Issued Date.	Page.
			C	Jan.16, 08	29 / 31

#### 12.4 Static electricity

Since a module is composed of electronic circuits, it is not strong to electrostatic discharge.

	<ol style="list-style-type: none"> <li>The LCD module shall be installed flat, without twisting or bending. Ground soldering iron tips, tools and testers when they operate.</li> <li>Ground your body when handling the products.</li> <li>DO NOT apply voltage to the input terminal without applying power supply.</li> <li>DO NOT apply voltage that exceeds the absolute maximum rating.</li> <li>Store the products in an anti-electrostatic container.</li> <li>Peel off protect tape, attached to polarizer, slowly to minimize ESD damage.</li> </ol>
---	--

#### 12.5 Storage

	<p>Store the products in a dark place at +5 ~ +25 degree C, low humidity (50%RH or less). DO NOT store the products in an atmosphere containing organic solvents or corrosive gases.</p>
---	--

#### 12.6 Cleaning

	<ol style="list-style-type: none"> <li>DO NOT wipe the polarizer with dry cloth, as it might cause scratch.</li> <li>Wipe the polarizer with a soft cloth soaked with petroleum IPA, other chemical might damage.</li> </ol>
---	--

#### 12.7 Waste

	<p>When dispose of LCD module, manage it at the production waste according to the relevant laws and regulations.</p>
---	--



Messrs.					
Product Specification	Model:	MTF-TQ35SP741-AV	Rev. No.	Issued Date.	Page.
			C	Jan.16, 08	30 / 31

### 13. WARRANTY

This product has been manufactured to your company's specifications as a part for use in your company's general electronic products. It is guaranteed to perform according to delivery specifications. For any other use apart from general electronic equipment, we cannot take responsibility if the product is used in medical devices, nuclear power control equipment, aerospace equipment, fire and security systems, or any other applications in which there is a direct risk to human life and where extremely high levels of reliability are required. If the product is to be used in any of the above applications, we will need to enter into a separate product liability agreement.

- 1 We cannot accept responsibility for any defect, which may arise from additional manufacturing of the product (including disassembly and reassembly), after product delivery.
- 2 We cannot accept responsibility for any defect, which may arise after the application of strong external force to the product.
- 3 We cannot accept responsibility for any defect, which may arise due to the application of static electricity after the product has passed your company's acceptance inspection procedures.
- 4 We cannot accept responsibility for industrial property, which may arise through the use of your product, with exception to those issues relating directly to the structure or method of manufacturing of our product. Microtips-origin longer than one year from Microtips production.

### 14. DIMENSIONAL OUTLINES

See Next page....



*Microtips Technology Inc.*

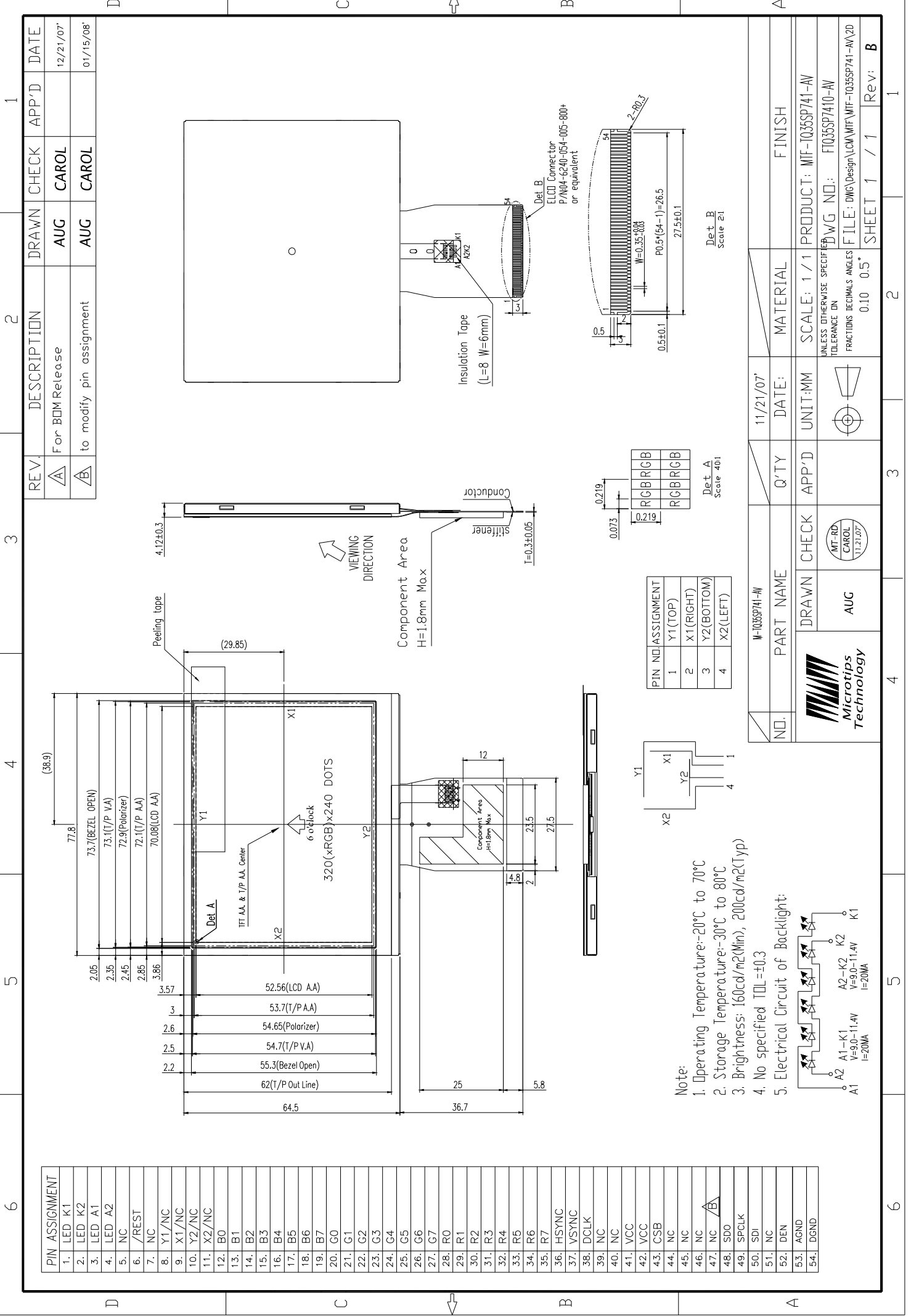

PIN ASSIGNMENT
1. LED K1
2. LED K2
3. LED A1
4. LED A2
5. NC
6. /REST
7. NC
8. Y1/NC
9. X1/NC
10. Y2/NC
11. X2/NC
12. B0
13. B1
14. B2
15. B3
16. B4
17. B5
18. B6
19. B7
20. G0
21. G1
22. G2
23. G3
24. G4
25. G5
26. G6
27. G7
28. R0
29. R1
30. R2
31. R3
32. R4
33. R5
34. R6
35. R7
36. HSYNC
37. VSYNC
38. DCLK
39. NC
40. NC
41. VCC
42. VCC
43. CSB
44. NC
45. NC
46. NC
47. NC
48. SDO
49. SCLK
50. SDI
51. NC
52. DEN
53. AGND
54. DGND

- Note:
1. Operating Temperature: -20°C to 70°C
  2. Storage Temperature: -30°C to 80°C
  3. Brightness: 160cd/m<sup>2</sup>(Min), 200cd/m<sup>2</sup>(Typ)
  4. No specified TOL=±0.3
  5. Electrical Circuit of Backlight:

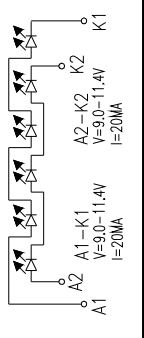

PIN NO.	ASSIGNMENT
1	Y1(TOP)
2	X1(RIGHT)
3	Y2(BOTTOM)
4	X2(LEFT)

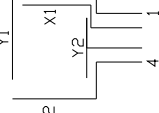

REV.	DESCRIPTION	DRAWN	CHECK	APP'D	DATE
A	For BOM Release	AUG	CAROL		12/21/07
B	to modify pin assignment	AUG	CAROL		01/15/08

NO.	PART NAME	Q'TY	DATE:	MATERIAL	FINISH
	W-1035SP741-AW		11/21/07		
	DRAWN	CHECK	APP'D	SCALE: 1/1	PRODUCT: MIF-1035SP741-AV
	AUG			UNLESS OTHERWISE SPECIFIED TOLERANCE ON FRACTIONS DECIMALS ANGLES 0.10 0.5°	DWG NO.: F1035SP7410-AW
				FILE: DWG\Design\LCM\WIF-WIF-1035SP741-AW.2D	SHEET 1 / 1
					Rev: B

