

STELLA-FRESNEL

~25° beam for warehouse and outdoor lighting.
Compatible with up to 30 mm LES size COBs.
Variant with black frame.

TECHNICAL SPECIFICATIONS:

Dimensions	Ø 90.0 mm
Height	23 mm
Fastening	screw
ROHS compliant	yes 

MATERIAL SPECIFICATIONS:

Component	Type	Material	Colour	Finish
STELLA-FRESNEL	Single lens	Silicone	clear	
STELLA-FRAME	Holder	PA66	black	



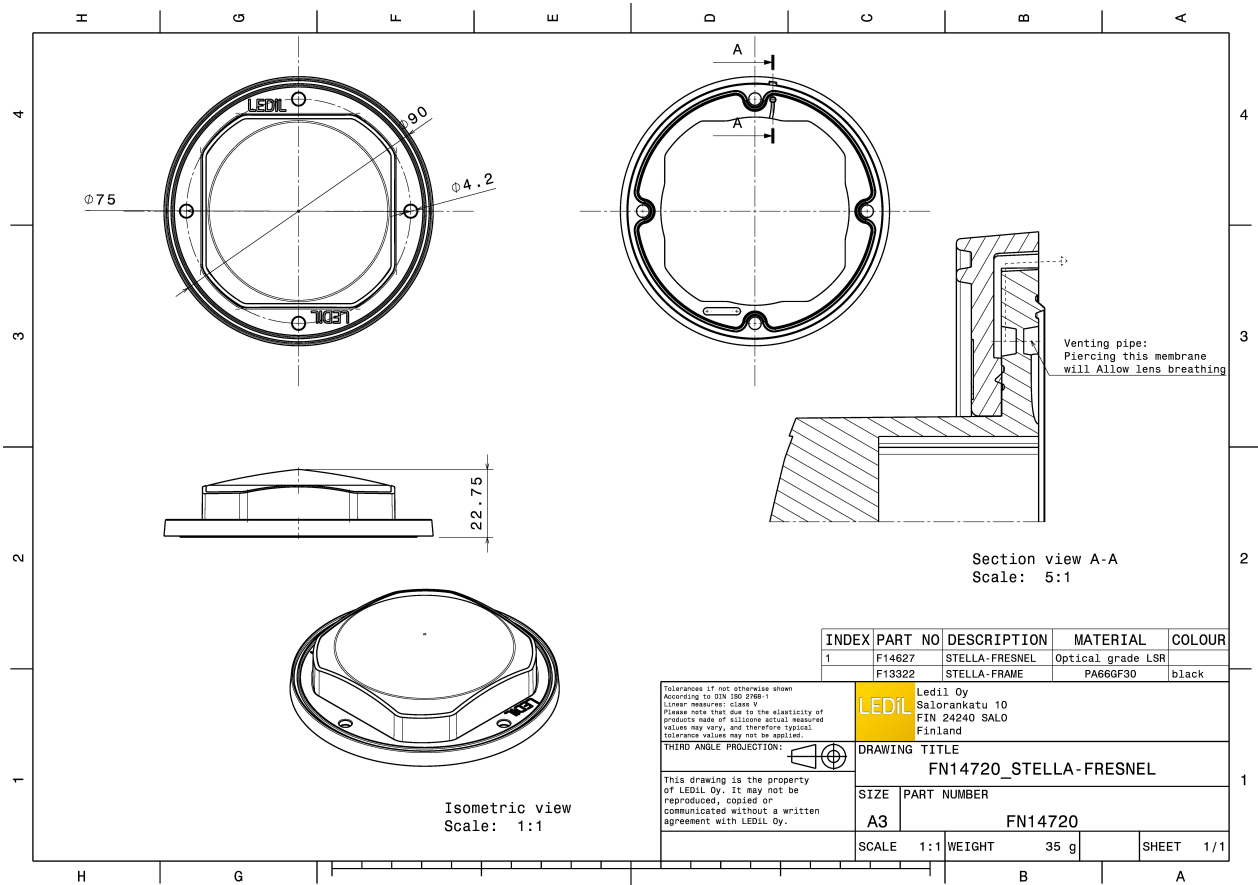

ORDERING INFORMATION:

Component		Qty in box	MOQ	MPQ	Box weight (kg)
FN14720_STELLA-FRESNEL	Single lens	80	80	10	4.0
» Box size: 480 x 280 x 300 mm					



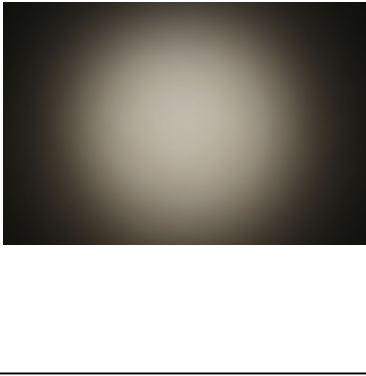
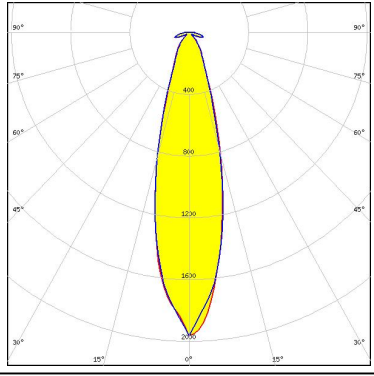
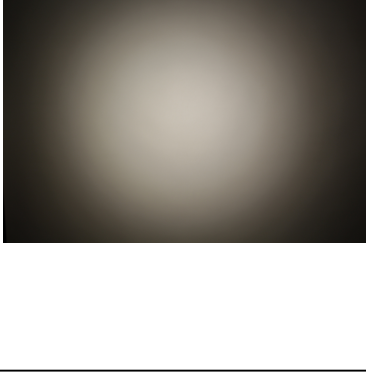
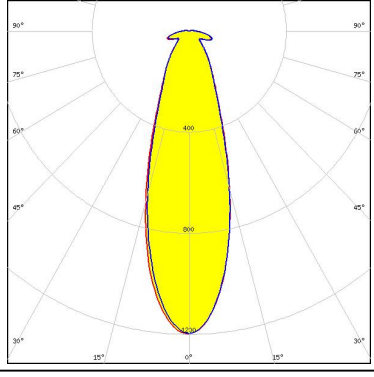

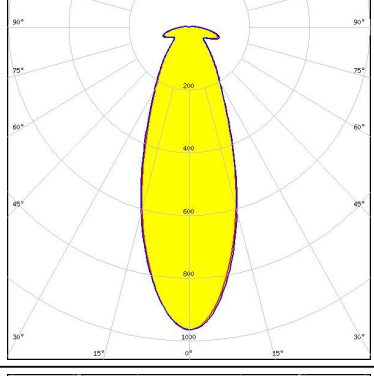
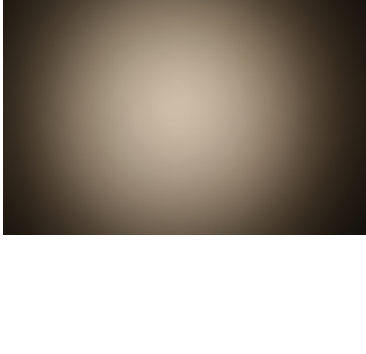
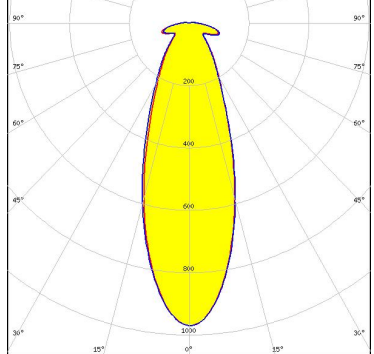

PHOTOMETRIC DATA (MEASURED):

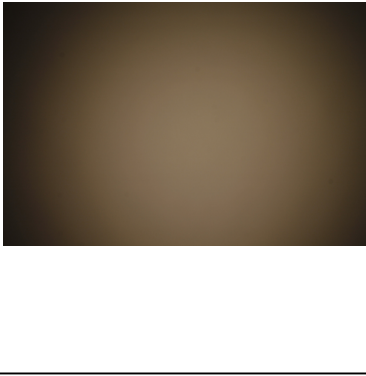
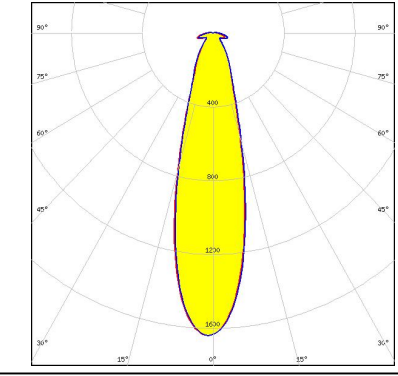
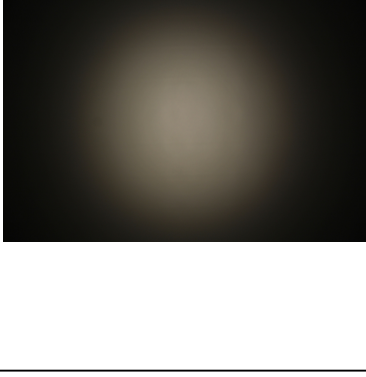
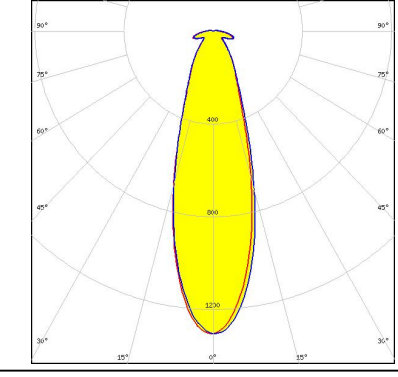
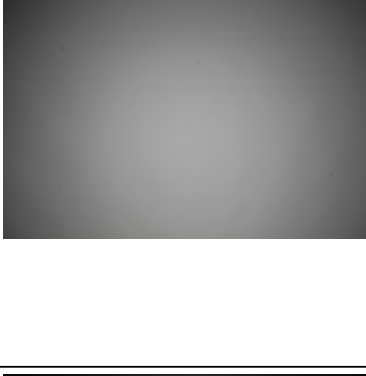
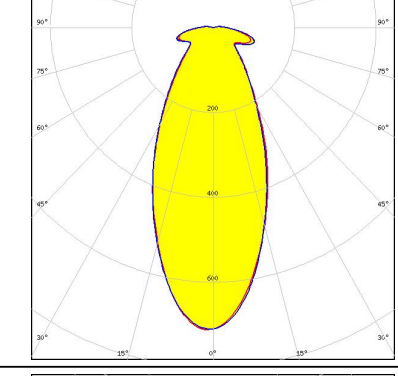
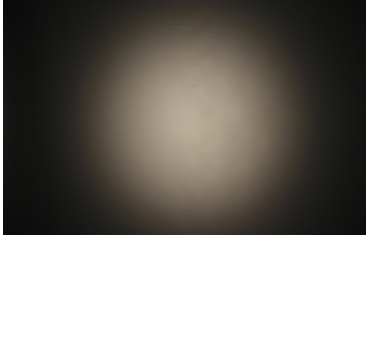
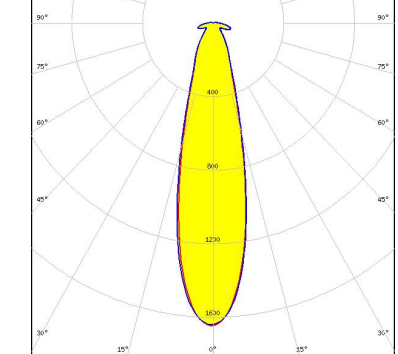
<p>bridgelux.</p> <p>LED V18 Gen7 FWHM 32.0° Efficiency 84 % Peak intensity 1.2 cd/lm LEDs/each optic 1 Light colour White Required components: BJB: 47.319.2350</p>		
<p>bridgelux.</p> <p>LED V18 Gen7 FWHM 32.0° Efficiency 85 % Peak intensity 1.2 cd/lm LEDs/each optic 1 Light colour White Required components: Bender Wirth: 439 Typ L3</p>		
<p>bridgelux.</p> <p>LED V22 Gen7 FWHM 37.0° Efficiency 86 % Peak intensity 1 cd/lm LEDs/each optic 1 Light colour White Required components: TE: 2213480-1</p>		
<p>bridgelux.</p> <p>LED V22 Gen7 FWHM 36.0° Efficiency 84 % Peak intensity 1 cd/lm LEDs/each optic 1 Light colour White Required components: Bender Wirth: 431 Typ Z1</p>		

PHOTOMETRIC DATA (MEASURED):

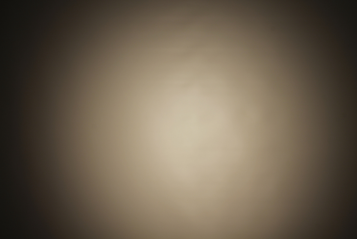
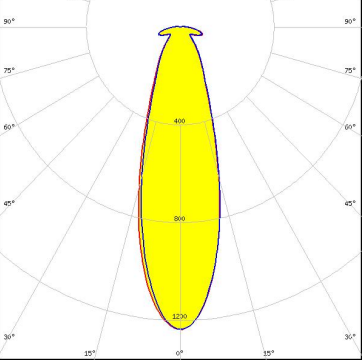
<p>bridgelux.</p> <p>LED Vero SE 13</p> <p>FWHM 27.0°</p> <p>Efficiency 85 %</p> <p>Peak intensity 1.6 cd/lm</p> <p>LEDs/each optic 1</p> <p>Light colour White</p> <p>Required components:</p>		
<p>bridgelux.</p> <p>LED Vero SE 18</p> <p>FWHM 31.0°</p> <p>Efficiency 86 %</p> <p>Peak intensity 1.3 cd/lm</p> <p>LEDs/each optic 1</p> <p>Light colour White</p> <p>Required components:</p>		
<p>bridgelux.</p> <p>LED Vero SE 29</p> <p>FWHM 46.0°</p> <p>Efficiency 87 %</p> <p>Peak intensity 0.7 cd/lm</p> <p>LEDs/each optic 1</p> <p>Light colour White</p> <p>Required components:</p>		
<p>bridgelux.</p> <p>LED VERO13</p> <p>FWHM 26.0°</p> <p>Efficiency 84 %</p> <p>Peak intensity 1.6 cd/lm</p> <p>LEDs/each optic 1</p> <p>Light colour White</p> <p>Required components:</p>		

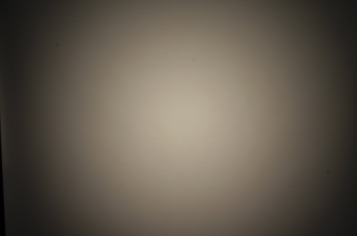
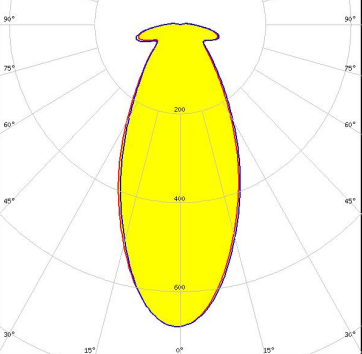
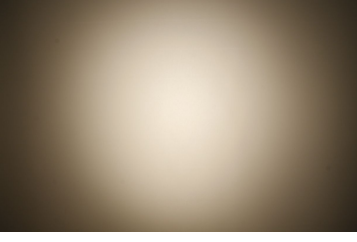
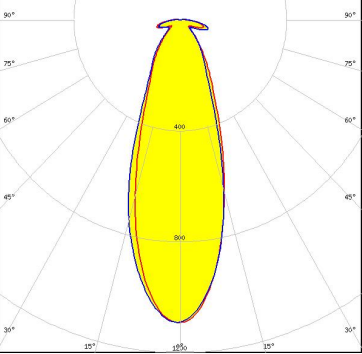
PHOTOMETRIC DATA (MEASURED):

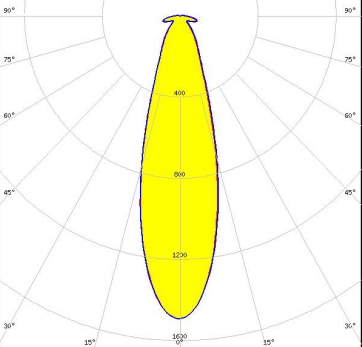
<p> bridgelux</p> <p>LED VERO18 FWHM 31.0° Efficiency 85 % Peak intensity 1.2 cd/lm LEDs/each optic 1 Light colour White Required components:</p>		
<p> bridgelux</p> <p>LED VERO29 FWHM 48.0° Efficiency 87 % Peak intensity 0.7 cd/lm LEDs/each optic 1 Light colour White Required components:</p>		
<p>CITIZEN</p> <p>LED CLL04x/CLU04x FWHM 36.0° Efficiency 86 % Peak intensity 1.1 cd/lm LEDs/each optic 1 Light colour White Required components:</p>		
<p> CREE</p> <p>LED CMA2550 FWHM 30.0° Efficiency 86 % Peak intensity 1.5 cd/lm LEDs/each optic 1 Light colour White Required components:</p>		

PHOTOMETRIC DATA (MEASURED):



LED CMA3090
 FWHM 35.0°
 Efficiency 88 %
 Peak intensity 1.2 cd/lm
 LEDs/each optic 1
 Light colour White
 Required components:

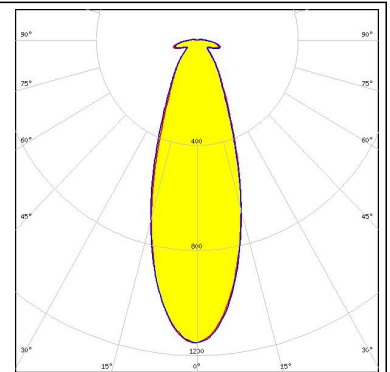
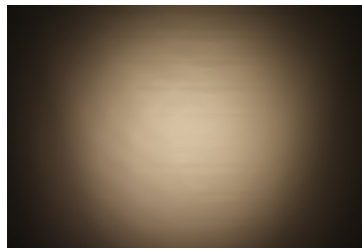

LED CMT19xx
 FWHM 25.0°
 Efficiency 87 %
 Peak intensity 2 cd/lm
 LEDs/each optic 1
 Light colour White
 Required components:
 Bender Wirth: 477 Typ Z1

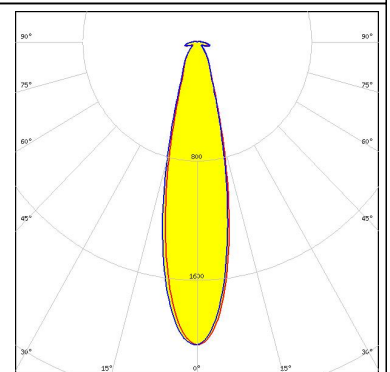

LED CXA/B 1816 & CXA/B 1820 & CXA 1850
 FWHM 24.0°
 Efficiency 84 %
 Peak intensity 1.9 cd/lm
 LEDs/each optic 1
 Light colour White
 Required components:

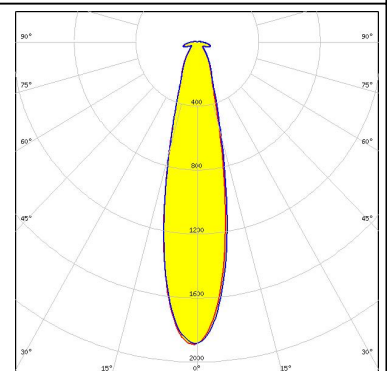
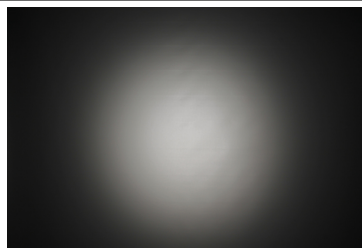

LED CXA/B 1830
 FWHM 26.0°
 Efficiency 85 %
 Peak intensity 1.6 cd/lm
 LEDs/each optic 1
 Light colour White
 Required components:
 C14305_STELLA-CLAMP-CXA15-18

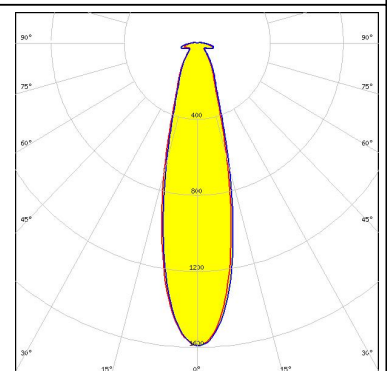
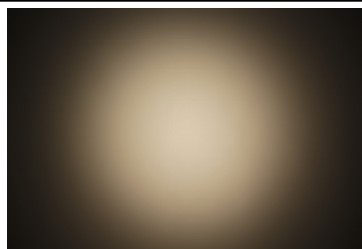

PHOTOMETRIC DATA (MEASURED):

CREE 

LED CXA/B 25xx
 FWHM 31.0°
 Efficiency 86 %
 Peak intensity 1.2 cd/lm
 LEDs/each optic 1
 Light colour White
 Required components:

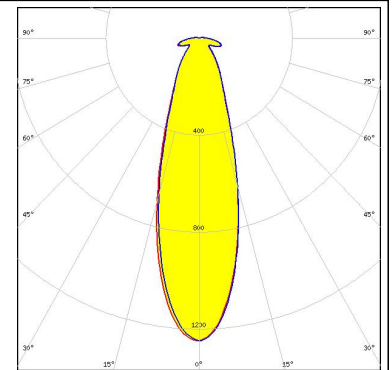

CREE 

LED CXA/B 25xx
 FWHM 33.0°
 Efficiency 84 %
 Peak intensity 1 cd/lm
 LEDs/each optic 1
 Light colour White
 Required components:

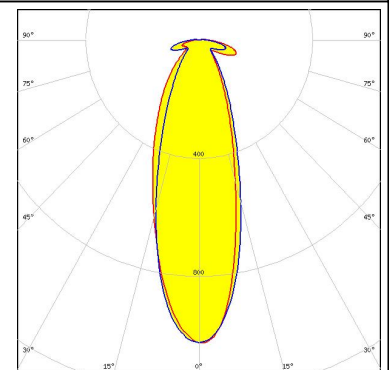
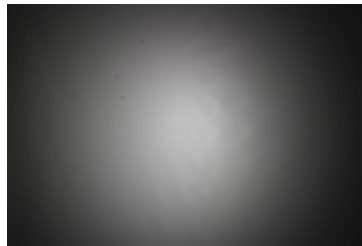

CREE 

LED CXA/B 25xx
 FWHM 32.0°
 Efficiency 85 %
 Peak intensity 1.2 cd/lm
 LEDs/each optic 1
 Light colour White
 Required components:
 Bender Wirth: 439 Typ L3

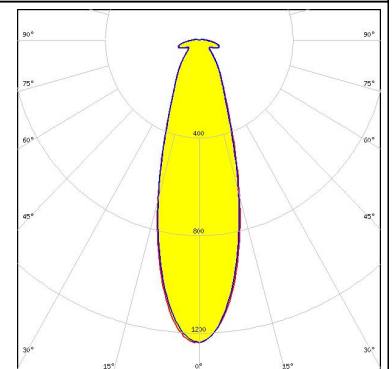

CREE 

LED CXA/B 30xx
 FWHM 37.0°
 Efficiency 88 %
 Peak intensity 1 cd/lm
 LEDs/each optic 1
 Light colour White
 Required components:
 BJB: 47.319.2151

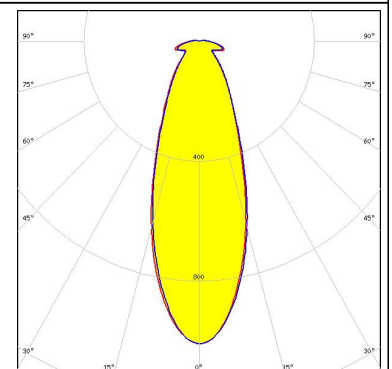
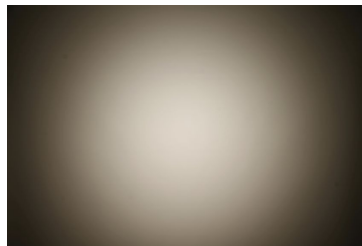

PHOTOMETRIC DATA (MEASURED):

LUMILEDS

LED LUXEON CoB 1211
FWHM 33.0°
Efficiency 85 %
Peak intensity 1.1 cd/lm
LEDs/each optic 1
Light colour White
Required components:
Bender Wirth: 431 Typ L3

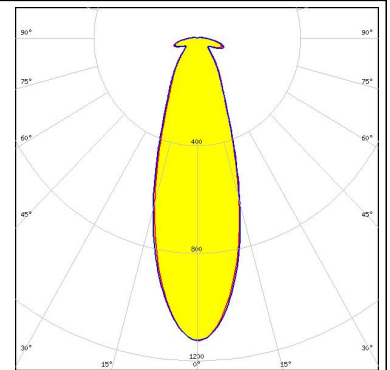
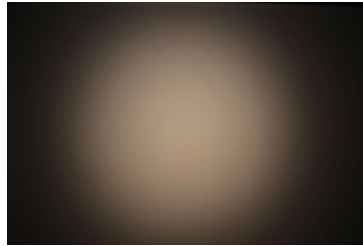

LUMILEDS

LED LUXEON CoB 1216/1812
FWHM 39.0°
Efficiency 86 %
Peak intensity 0.9 cd/lm
LEDs/each optic 1
Light colour White
Required components:

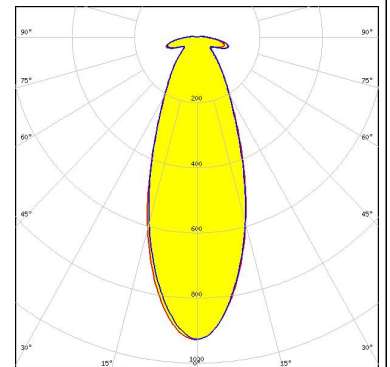

LUMILEDS

LED LUXEON CoB 1321
FWHM 50.0°
Efficiency 85 %
Peak intensity 0.6 cd/lm
LEDs/each optic 1
Light colour White
Required components:

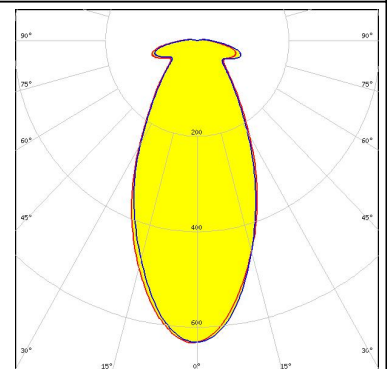
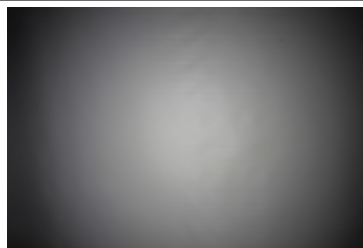

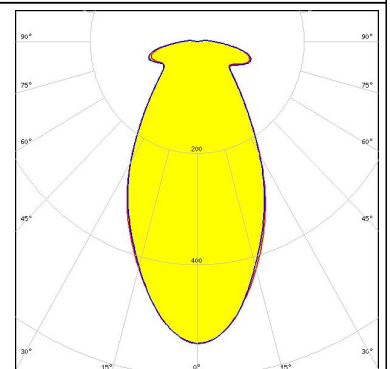
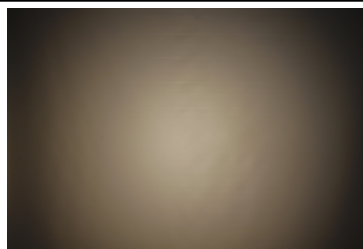

LUMILEDS

LED LUXEON CoB 1825
FWHM 56.0°
Efficiency 84 %
Peak intensity 0.5 cd/lm
LEDs/each optic 1
Light colour White
Required components:

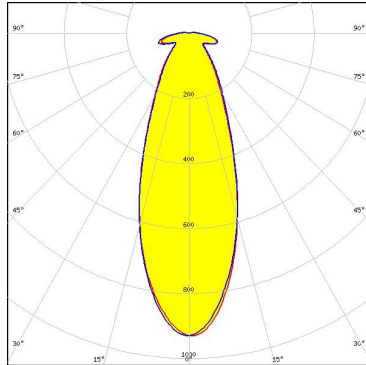
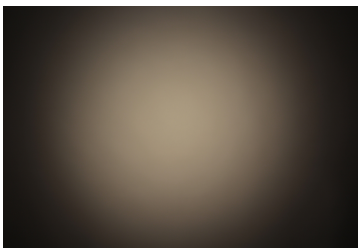
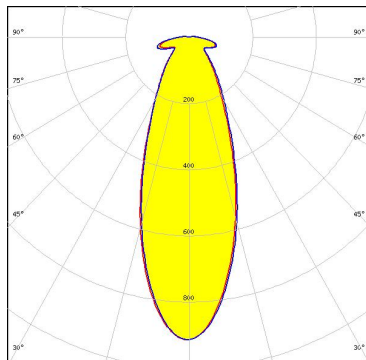

PHOTOMETRIC DATA (MEASURED):

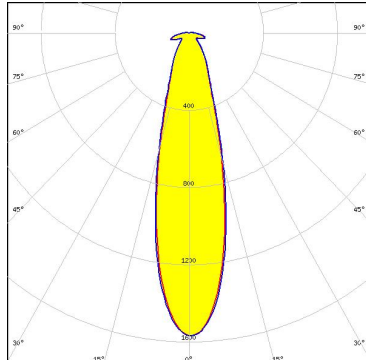
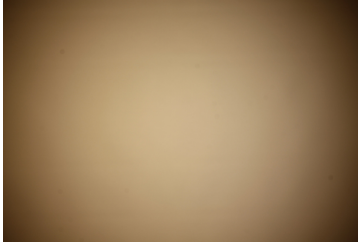
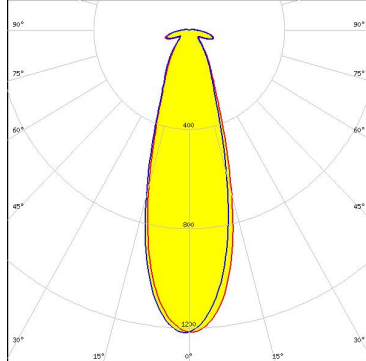
<p>LUMINUS</p> <p>LED CxM-22 (28x28) FWHM 38.0° Efficiency 86 % Peak intensity 0.9 cd/lm LEDs/each optic 1 Light colour White Required components: Bender Wirth: 431 Typ L3</p>		
<p>NICHIA</p> <p>LED COB H-Type FWHM 38.0° Efficiency 85 % Peak intensity 0.9 cd/lm LEDs/each optic 1 Light colour White Required components:</p>		
<p>NICHIA</p> <p>LED COB J-Type FWHM 26.0° Efficiency 85 % Peak intensity 1.6 cd/lm LEDs/each optic 1 Light colour White Required components:</p>		
<p>OSRAM <small>Opto Semiconductors</small></p> <p>LED Soleriq S19 FWHM 32.1° Efficiency 84 % Peak intensity 1.2 cd/lm LEDs/each optic 1 Light colour White Required components:</p>		

PHOTOMETRIC DATA (MEASURED):

PHILIPS

LED Fortimo SLM L06 CoB
 FWHM 18.0°
 Efficiency 86 %
 Peak intensity 2.9 cd/lm
 LEDs/each optic 1
 Light colour White
 Required components:

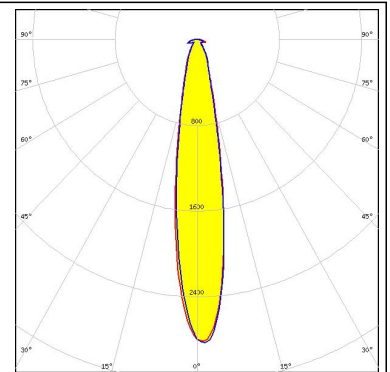
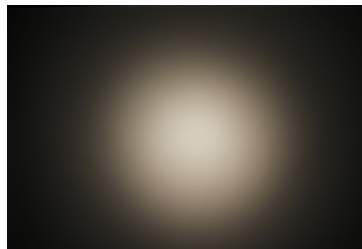

PHILIPS

LED Fortimo SLM L19 + SLM holder (PI)
 FWHM 33.0°
 Efficiency 87 %
 Peak intensity 1.2 cd/lm
 LEDs/each optic 1
 Light colour White
 Required components:

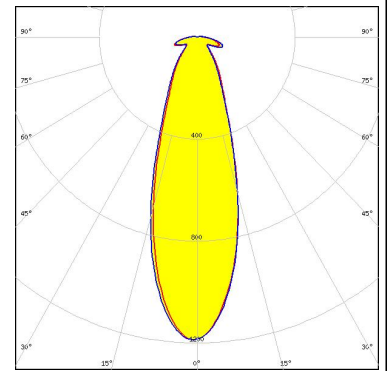
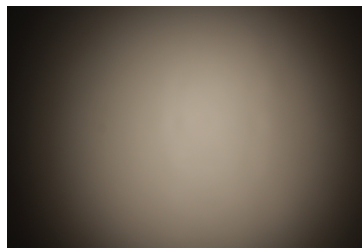

PHILIPS

LED Fortimo SLM L23 CoB
 FWHM 38.0°
 Efficiency 87 %
 Peak intensity 1 cd/lm
 LEDs/each optic 1
 Light colour White
 Required components:

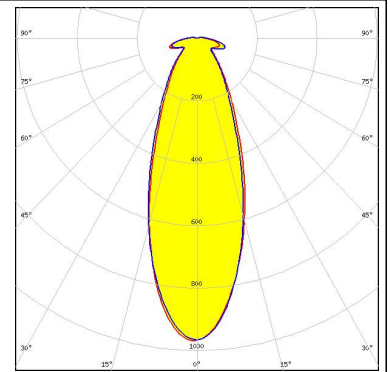
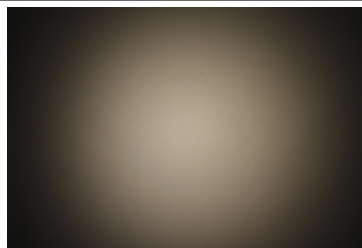

SAMSUNG

LED LC016D / LC019D / LC026D / LC033D
 FWHM 27.0°
 Efficiency 83 %
 Peak intensity 1.5 cd/lm
 LEDs/each optic 1
 Light colour White
 Required components:

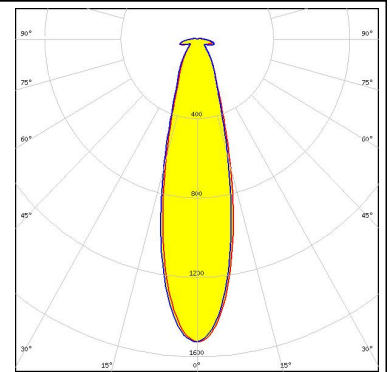
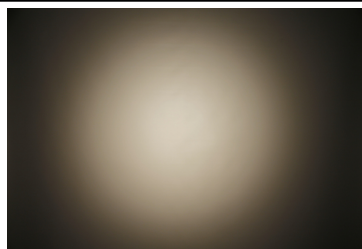

PHOTOMETRIC DATA (MEASURED):

SAMSUNG

LED LC040D / LC060D / LC080D
 FWHM 37.0°
 Efficiency 84 %
 Peak intensity 0.9 cd/lm
 LEDs/each optic 1
 Light colour White
 Required components:

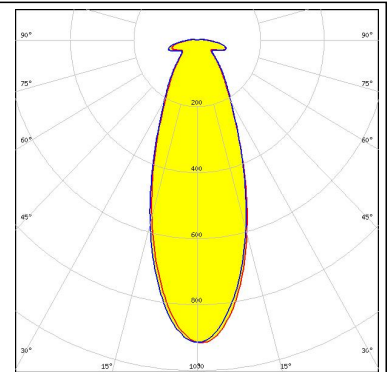
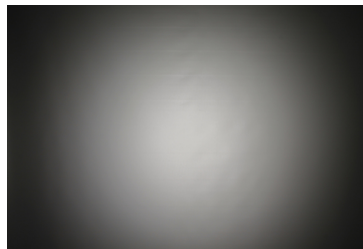

SEOUL SEMICONDUCTOR

LED MJT COB LES 14.5
 FWHM 28.0°
 Efficiency 84 %
 Peak intensity 1.5 cd/lm
 LEDs/each optic 1
 Light colour White
 Required components:
 IDEAL: 50-2103CT

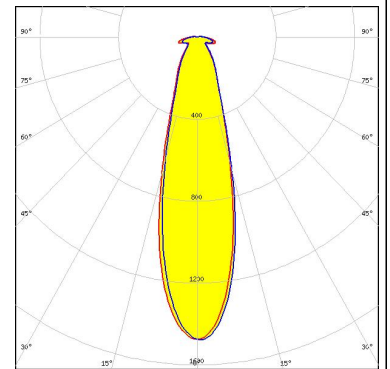

SEOUL SEMICONDUCTOR

LED MJT COB LES 22
 FWHM 36.0°
 Efficiency 84 %
 Peak intensity 1 cd/lm
 LEDs/each optic 1
 Light colour White
 Required components:
 IDEAL: 50-2204CT

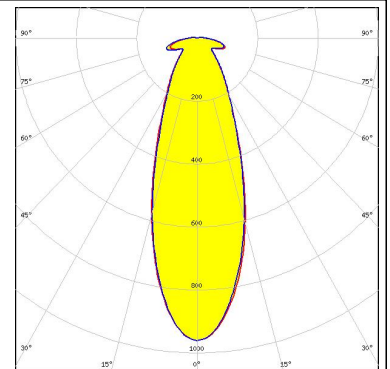
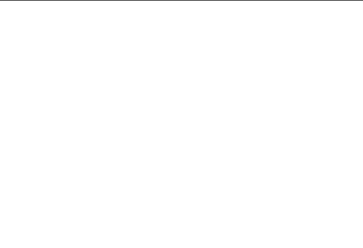

SEOUL SEMICONDUCTOR

LED MJT COB LES 22
 FWHM 36.0°
 Efficiency 84 %
 Peak intensity 1 cd/lm
 LEDs/each optic 1
 Light colour White
 Required components:
 IDEAL: 50-2204CT

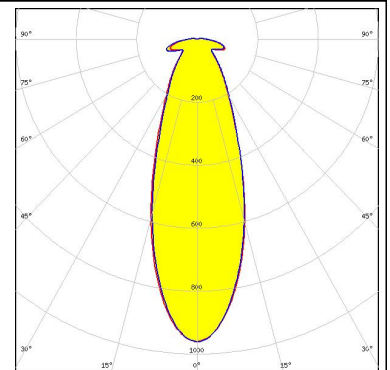
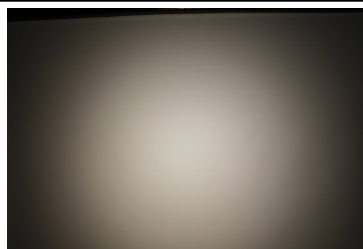

PHOTOMETRIC DATA (SIMULATED):

<p>bridgelux.</p> <p>LED V10 Gen7 FWHM 18.0° Efficiency 85 % Peak intensity 4 cd/lm LEDs/each optic 1 Light colour White Required components: Bender Wirth: 486 Typ L1</p>	
<p>bridgelux.</p> <p>LED V13 Gen7 FWHM Asymmetric Efficiency 86 % LEDs/each optic 1 Light colour White Required components:</p>	
<p>bridgelux.</p> <p>LED V22 Gen7 FWHM 30.0° Efficiency 84 % Peak intensity 0.5 cd/lm LEDs/each optic 1 Light colour White Required components: IDEAL: 50-2204CT</p>	
<p>CITIZEN</p> <p>LED CLL02x/CLU02x (LES10) FWHM 17.0° Efficiency 86 % Peak intensity 4 cd/lm LEDs/each optic 1 Light colour White Required components:</p>	

PHOTOMETRIC DATA (SIMULATED):

CITIZEN

LED CLL05x/CLU05x
 FWHM 46.0°
 Efficiency 91 %
 Peak intensity 0.8 cd/lm
 LEDs/each optic 1
 Light colour White
 Required components:

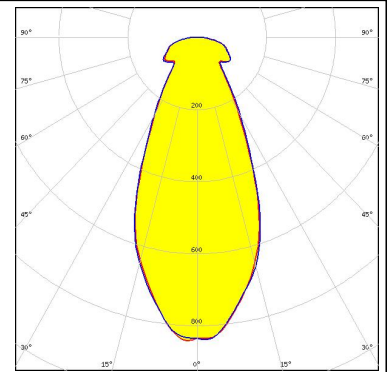

CREE

LED CMA3090
 FWHM 31.0°
 Efficiency %
 Peak intensity 1.6 cd/lm
 LEDs/each optic 1
 Light colour White
 Required components:

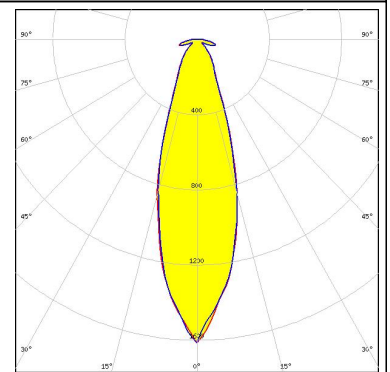

CREE

LED CXA/B 3590
 FWHM 37.0°
 Efficiency 83 %
 Peak intensity 1.1 cd/lm
 LEDs/each optic 1
 Light colour White
 Required components:

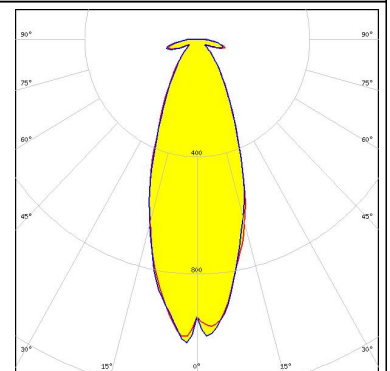

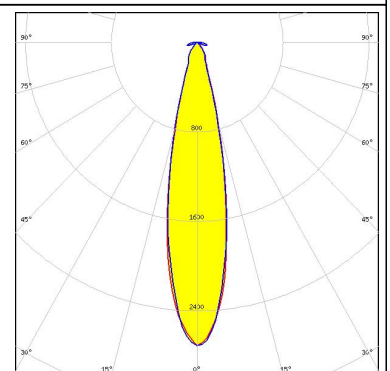

LUMILEDS

LED LUXEON CoB 1208
 FWHM 23.0°
 Efficiency 82 %
 Peak intensity 2.8 cd/lm
 LEDs/each optic 1
 Light colour White
 Required components:

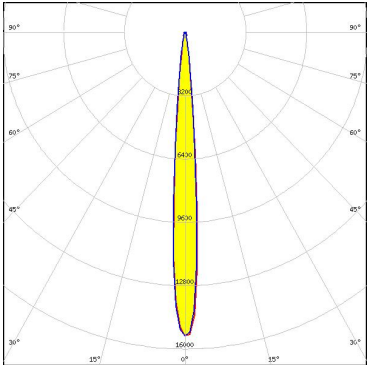

PHOTOMETRIC DATA (SIMULATED):

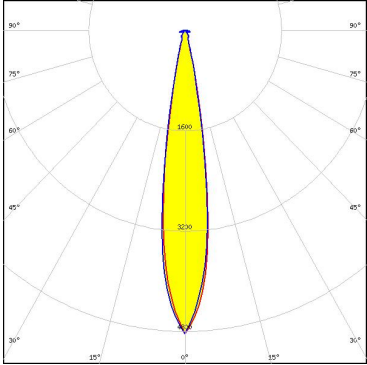
<p></p> <p>LED NCSU334A FWHM 4.0° Efficiency 64 % LEDs/each optic 1 Light colour UV Required components:</p>	
<p></p> <p>LED WICOP DY9560-27 FWHM 15.0° Efficiency 63 % LEDs/each optic 24 Light colour UV Required components:</p>	

GENERAL INFORMATION:

NOTE: The typical beam angle will be changed by different color, chip size and chip position tolerance. The typical total beam angle is the full angle measured where the luminous intensity is half of the peak value.

Due to use of high power COB's with this product, special attention to proper thermal design is highly recommended. LEDiL has no liability for direct, indirect or consecutive damages arising from the LEDiL products being used outside of the recommended temperature range.

MATERIALS:

As part of our continuous research and improvement processes, and to ensure the best possible quality and availability of our products, LEDiL reserves the right to change material grades without notice.

PRODUCT DATA USER AGREEMENT AND DISCLAIMER:

The measured data in the provided downloadable LEDiL Product Datasheets and Mechanical 2D-Drawings is rounded and provided as reference for planning. LEDiL Oy's optical specifications have been verified by conducting performance testing of the products in accordance with the company's quality system. The reported data are averaged results of multiple measurements with typical variation. LEDiL Oy reserves the right to without prior notification make changes and improvements to its products.

LEDiL Oy assumes neither warranty, nor guarantee nor any other liability of any kind for the contents and correctness of the provided data. The provided data has been generated with highest diligence but the provided data may in reality not represent the complete possible variation range of all intrinsic parameters. Therefore, in certain cases a deviation from the provided data could occur.

LEDiL Oy reserves the right to undertake technical changes of its products without further notification which could lead to changes in the provided data. LEDiL Oy assumes no liability of any kind for the possible deviation from any provided data or any other damage resulting from the usage of the provided data.

The user agrees to this disclaimer and user agreement with the download or usage of the provided files.

LEDiL Oy

Joensuunkatu 13
FI-24240 SALO
Finland

LEDiL Inc.

228 West Page Street
Suite D
Sycamore IL 60178
USA

Local sales and technical support

www.ledil.com/where_to_buy

Shipping locations

Salo, Finland
Hong Kong, China

Distribution Partners

www.ledil.com/where_to_buy