

High side current sense high voltage op amp

Datasheet - production data

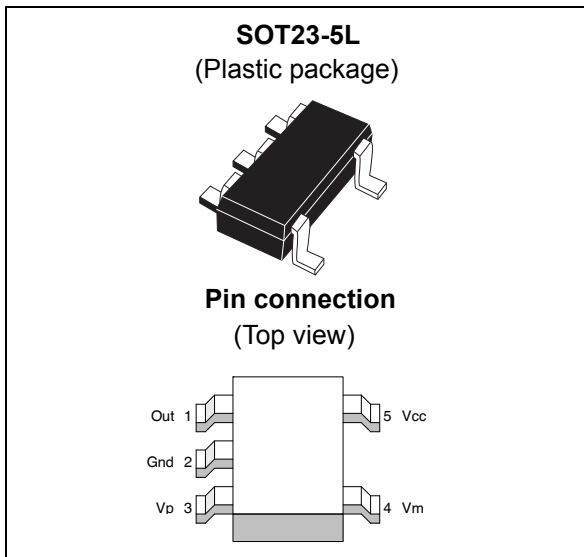

Applications

- Wireless battery chargers
- Chargers for portable equipment
- Precision current sources
- Wearable

Description

The CS30 measures a small differential voltage on a high-side shunt resistor and translates it into a ground referenced output voltage. The gain is internally fixed.

Wide input common-mode voltage range, low quiescent current, and tiny SOT23 packaging enable use in a wide variety of applications.

The input common-mode and power supply voltages are independent. The common-mode voltage can range from 2.8 to 30 V in operating conditions and up to 60 V in absolute maximum rating conditions.

The current consumption below 300 μA and the wide supply voltage range enable the power supply to be connected to either side of the current measurement shunt with minimal error.

Features

- Independent supply and input common-mode voltages
- Wide common-mode operating range: 2.8 to 30 V
- Wide common-mode surviving range: - 0.3 to 60 V (load-dump)
- Wide supply voltage range: 4 to 24 V
- Low current consumption: I_{CC} max = 300 μA
- Internally fixed gain: 20 V/V, 50 V/V or 100 V/V
- Buffered output

Table 1. Device summary

| Part number | Temperature range | Package | Packaging | Marking | Gain |
|-------------|-------------------|----------|-------------|---------|------|
| CS30AL | -40°C to +125°C | SOT23-5L | Tape & reel | O104 | 20 |
| CS30BL | | | | O105 | 50 |
| CS30CL | | | | O106 | 100 |

Contents

- 1 Application schematic and pin description 3**
- 2 Absolute maximum ratings and operating conditions 4**
- 3 Electrical characteristics 5**
 - 3.1 Electrical characteristics curves 8
- 4 Parameter definitions 12**
 - 4.1 Common mode rejection ratio (CMR) 12
 - 4.2 Supply voltage rejection ratio (SVR) 12
 - 4.3 Gain (A_v) and input offset voltage (V_{os}) 12
 - 4.4 Output voltage drift versus temperature 13
 - 4.5 Output voltage accuracy 14
- 5 Application information 15**
- 6 Package information 16**
- 7 Revision history 17**

1 Application schematic and pin description

The CS30 high-side current sense amplifier features a 2.8 to 30 V input common-mode range that is independent of the supply voltage. The main advantage of this feature is that it allows high-side current sensing at voltages much greater than the supply voltage (V_{CC}).

Figure 1. Application schematic

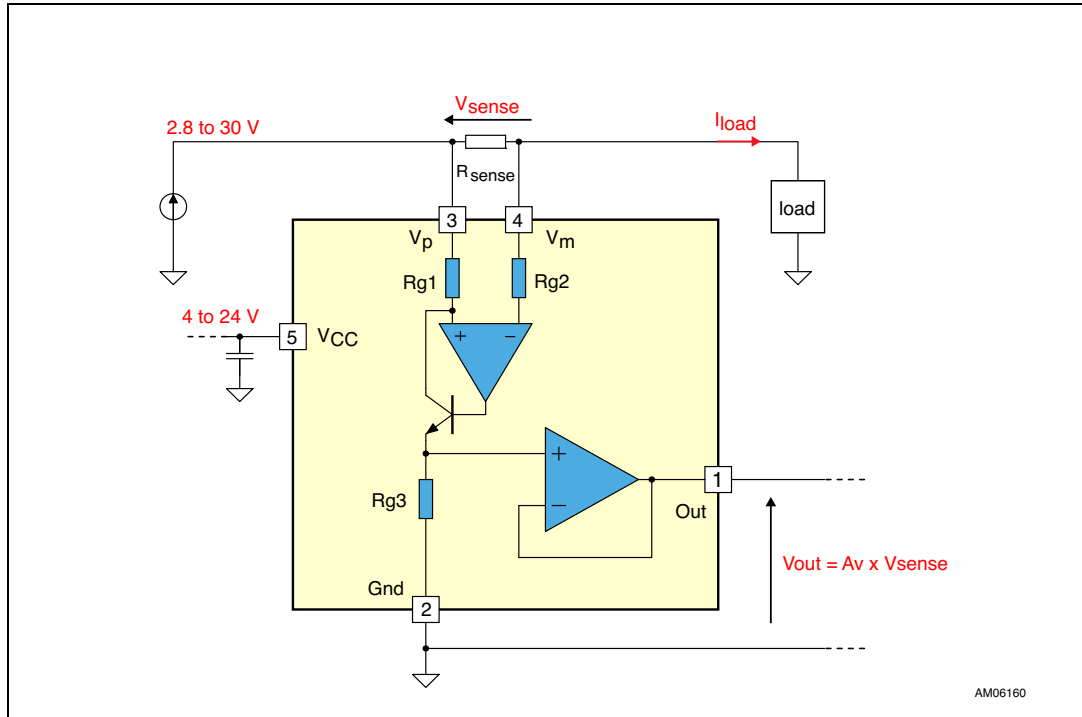

Table 2 describes the function of each pin. The pin positions are shown in the illustration on the cover page and in Figure 1 above.

Table 2. Pin description

| Symbol | Type | Function |
|----------|---------------|---|
| Out | Analog output | Output voltage, proportional to the magnitude of the sense voltage $\overline{V_p - V_m}$. |
| Gnd | Power supply | Ground line |
| V_{CC} | Power supply | Positive power supply line |
| V_p | Analog input | Connection for the external sense resistor. The measured current enters the shunt on the $\overline{V_p}$ side. |
| V_m | Analog input | Connection for the external sense resistor. The measured current exits the shunt on the $\overline{V_m}$ side. |

2 Absolute maximum ratings and operating conditions

Table 3. Absolute maximum ratings

| Symbol | Parameter | Value | Unit |
|------------|---|------------------|------|
| V_{id} | Input pins differential voltage ($V_p - V_m$) | ± 60 | V |
| V_i | Input pin voltages (V_p and V_m) ⁽¹⁾ | -0.3 to 60 | V |
| V_{CC} | DC supply voltage ⁽¹⁾ | -0.3 to 25 | V |
| V_{out} | DC output pin voltage ⁽¹⁾ | -0.3 to V_{CC} | V |
| T_{stg} | Storage temperature | -55 to 150 | °C |
| T_j | Maximum junction temperature | 150 | °C |
| R_{thja} | SOT23-5 thermal resistance junction to ambient | 250 | °C/Ω |
| ESD | HBM: human body model ⁽²⁾ | 2.5 | kV |
| | MM: machine model ⁽³⁾ | 150 | V |
| | CDM: charged device model ⁽⁴⁾ | 1.5 | kV |

1. Voltage values are measured with respect to the ground pin.
2. Human body model: a 100 pF capacitor is charged to the specified voltage, then discharged through a 1.5kΩ resistor between two pins of the device. This is done for all couples of connected pin combinations while the other pins are floating.
3. Machine model: a 200 pF capacitor is charged to the specified voltage, then discharged directly between two pins of the device with no external series resistor (internal resistor < 5 Ω). This is done for all couples of connected pin combinations while the other pins are floating.
4. Charged device model: all pins plus package are charged together to the specified voltage and then discharged directly to the ground.

Table 4. Operating conditions

| Symbol | Parameter | Value | Unit |
|------------|--|------------|------|
| V_{CC} | DC supply voltage from T_{min} to T_{max} | 4.0 to 24 | V |
| T_{oper} | Operational temperature range (T_{min} to T_{max}) | -40 to 125 | °C |
| V_{icm} | Common mode voltage range | 2.8 to 30 | V |

3 Electrical characteristics

Table 5. Supply⁽¹⁾

| Symbol | Parameter | Test conditions | Min. | Typ. | Max. | Unit |
|----------|----------------------|---|------|------|------|---------------|
| I_{CC} | Total supply current | $V_{sense} = 0\text{ V}$ $T_{min} < T_{amb} < T_{max}$ | | 165 | 300 | μA |

1. Unless otherwise specified, the test conditions are $T_{amb} = 25^\circ\text{C}$, $V_{CC} = 12\text{ V}$, $V_{sense} = V_p - V_m = 50\text{ mV}$, $V_m = 12\text{ V}$, no load on Out.

Table 6. Input⁽¹⁾

| Symbol | Parameter | Test conditions | Min. | Typ. | Max. | Unit |
|--------------|--|--|------|------------------------|------------------------|------------------------------|
| CMR | Common mode rejection Variation of V_{out} versus V_{icm} referred to input ⁽²⁾ | $2.8\text{ V} < V_{icm} < 30\text{ V}$ $T_{min} < T_{amb} < T_{max}$ | 90 | 105 | | dB |
| SVR | Supply voltage rejection Variation of V_{out} versus V_{CC} ⁽³⁾ | $4.0\text{ V} < V_{CC} < 24\text{ V}$ $V_{sense} = 30\text{ mV}$ $T_{min} < T_{amb} < T_{max}$ | 90 | 105 | | dB |
| V_{os} | Input offset voltage ⁽⁴⁾ | $T_{amb} = 25^\circ\text{C}$ $T_{min} < T_{amb} < T_{max}$ | | ± 0.2 ± 0.9 | ± 1.5 ± 2.3 | mV |
| dV_{os}/dT | Input offset drift vs. T | $T_{min} < T_{amb} < T_{max}$ | | -3 | | $\mu\text{V}/^\circ\text{C}$ |
| I_{lk} | Input leakage current | $V_{CC} = 0\text{ V}$ $T_{min} < T_{amb} < T_{max}$ | | | 1 | μA |
| I_{ib} | Input bias current | $V_{sense} = 0\text{ V}$ $T_{min} < T_{amb} < T_{max}$ | | 5.5 | 8 | μA |

1. Unless otherwise specified, the test conditions are $T_{amb} = 25^\circ\text{C}$, $V_{CC} = 12\text{ V}$, $V_{sense} = V_p - V_m = 50\text{ mV}$, $V_m = 12\text{ V}$, no load on Out.

2. See [Section 4.1: Common mode rejection ratio \(CMR\) on page 12](#) for the definition of CMR.

3. See [Section 4.2: Supply voltage rejection ratio \(SVR\) on page 12](#) for the definition of SVR.

4. See [Section 4.3: Gain \(\$A_v\$ \) and input offset voltage \(\$V_{os}\$ \) on page 12](#) for the definition of V_{os} .

Table 7. Output⁽¹⁾

| Symbol | Parameter | Test conditions | Min. | Typ. | Max. | Unit |
|---------------------------------|---|--|------|-----------------|------------------------|-------|
| A_v | Gain | CS30A CS30B CS30C | | 20 50 100 | | V/V |
| ΔA_v | Gain accuracy | $T_{amb} = 25^\circ C$ $T_{min} < T_{amb} < T_{max}$ | | | ± 2.5 ± 4.5 | % |
| $\Delta V_{out}/\Delta T$ | Output voltage drift vs. T ⁽²⁾ | $T_{min} < T_{amb} < T_{max}$ | | 0.4 | | mV/°C |
| $\Delta V_{out}/\Delta I_{out}$ | Output stage load regulation | $-10 \text{ mA} < I_{out} < 10 \text{ mA}$ I_{out} sink or source current | | 3 | 4 | mV/mA |
| ΔV_{out} | Total output voltage accuracy ⁽³⁾ | $V_{sense} = 50 \text{ mV}$ $T_{amb} = 25^\circ C$ $T_{min} < T_{amb} < T_{max}$ | | | ± 2.5 ± 4.5 | % |
| ΔV_{out} | Total output voltage accuracy | $V_{sense} = 100 \text{ mV}$ $T_{amb} = 25^\circ C$ $T_{min} < T_{amb} < T_{max}$ | | | ± 3.5 ± 5 | % |
| ΔV_{out} | Total output voltage accuracy | $V_{sense} = 20 \text{ mV}$ $T_{amb} = 25^\circ C$ $T_{min} < T_{amb} < T_{max}$ | | | ± 8 ± 11 | % |
| ΔV_{out} | Total output voltage accuracy | $V_{sense} = 10 \text{ mV}$ $T_{amb} = 25^\circ C$ $T_{min} < T_{amb} < T_{max}$ | | | ± 15 ± 20 | % |
| $I_{sc-sink}$ | Short-circuit sink current | Out connected to V_{CC} , $V_{sense} = -1 \text{ V}$ | 30 | 60 | | mA |
| $I_{sc-source}$ | Short-circuit source current | Out connected to Gnd $V_{sense} = 1 \text{ V}$ | 15 | 26 | | mA |
| V_{oh} | Output stage high-state saturation voltage $V_{oh} = V_{CC} - V_{out}$ | $V_{sense} = 1 \text{ V}$ $I_{out} = 1 \text{ mA}$ | | 0.8 | 1 | V |
| V_{ol} | Output stage low-state saturation voltage | $V_{sense} = -1 \text{ V}$ $I_{out} = 1 \text{ mA}$ | | 50 | 100 | mV |

1. Unless otherwise specified, the test conditions are $T_{amb} = 25^\circ C$, $V_{CC} = 12 \text{ V}$, $V_{sense} = V_p - V_m = 50 \text{ mV}$, $V_m = 12 \text{ V}$, no load on Out.
2. See [Output voltage drift versus temperature on page 13](#) for the definition.
3. Output voltage accuracy is the difference with the expected theoretical output voltage $V_{out-th} = A_v \cdot V_{sense}$. See [Output voltage accuracy on page 14](#) for a more detailed definition.

Table 8. Frequency response⁽¹⁾

| Symbol | Parameter | Test conditions | Min. | Typ. | Max. | Unit |
|--------|-----------------------------------|---|------|-------------------|------|------|
| ts | Output settling to 1% final value | V _{sense} = 10 mV to 100 mV C _{load} = 47 pF ⁽²⁾ CS30A CS30B CS30C | | 3 6 10 | | μs |
| SR | Slew rate | V _{sense} = 10 mV to 100 mV | 0.55 | 0.9 | | V/μs |
| BW | 3dB bandwidth | C _{load} = 47 pF ⁽²⁾ V _{sense} = 100 mV CS30A CS30B CS30C | | 500 670 450 | | kHz |

1. Unless otherwise specified, the test conditions are T_{amb} = 25°C, V_{CC} = 12 V, V_{sense} = V_p-V_m = 50 mV, V_m = 12 V, no load on Out.
2. For stability purposes, we do not recommend using a greater value of load capacitor.

Table 9. Noise⁽¹⁾

| Symbol | Parameter | Test conditions | Min. | Typ. | Max. | Unit |
|--------|----------------------------|-----------------|------|------|------|--------|
| | Total output voltage noise | | | 50 | | nV/√Hz |

1. Unless otherwise specified, the test conditions are T_{amb} = 25°C, V_{CC} = 12 V, V_{sense} = V_p-V_m = 50 mV, V_m = 12 V, no load on Out.

3.1 Electrical characteristics curves

For the following curves, the tested device is a CS30C, and the test conditions are $T_{amb} = 25^{\circ}\text{C}$, $V_{CC} = 12\text{ V}$, $V_{sense} = V_p - V_m = 50\text{ mV}$, $V_m = 12\text{ V}$, no load on Out unless otherwise specified.

Figure 2. Supply current vs. supply voltage
($V_{sense} = 0\text{ V}$)

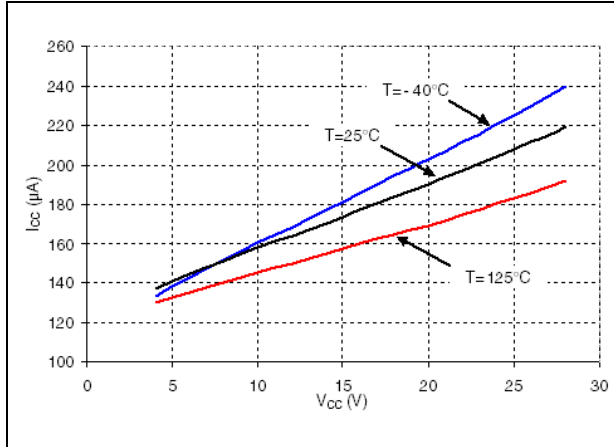

Figure 3. Supply current vs. V_{sense}

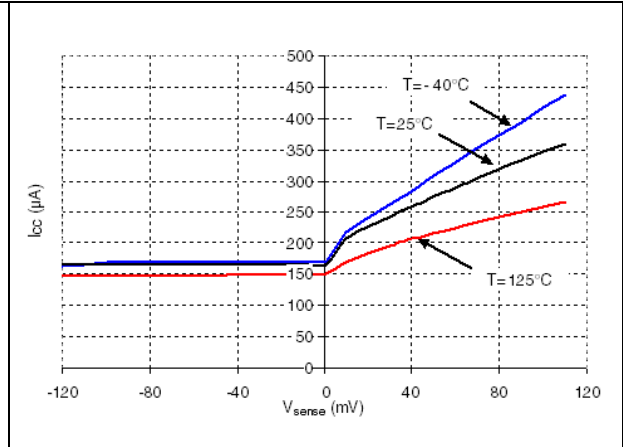

Figure 4. V_p pin input bias current vs. V_{sense}

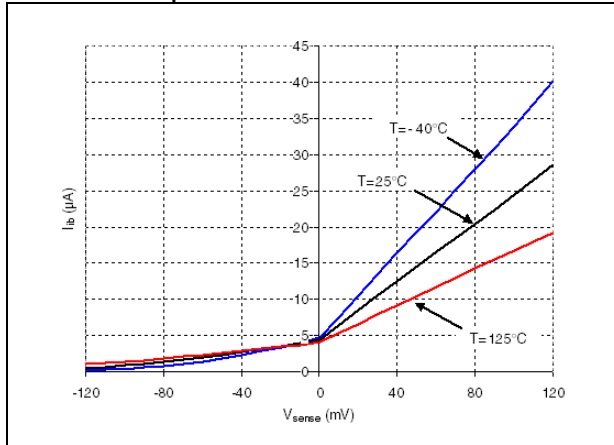

Figure 5. V_m pin input bias current vs. V_{sense}

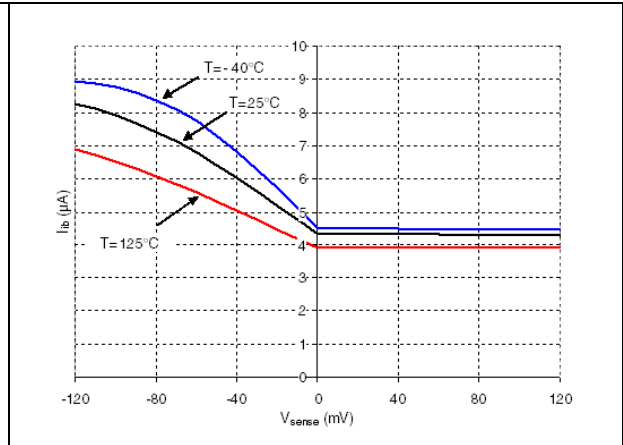

Figure 6. Minimum common mode operating voltage vs. temperature

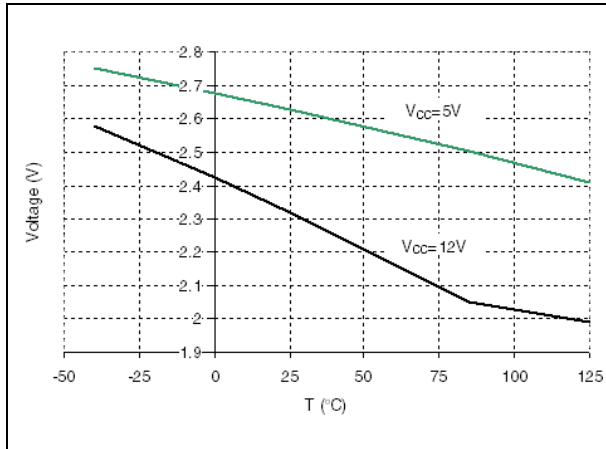

Figure 7. Output stage low-state saturation voltage versus output current (V_{sense} = -1 V)

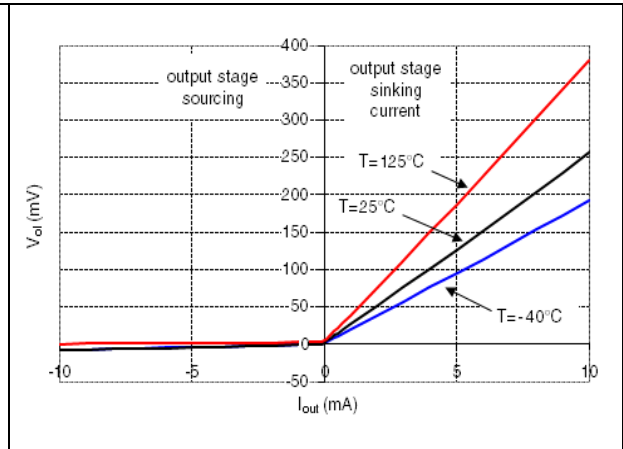

Figure 8. Output stage high-state saturation voltage versus output current (V_{sense} = +1 V)

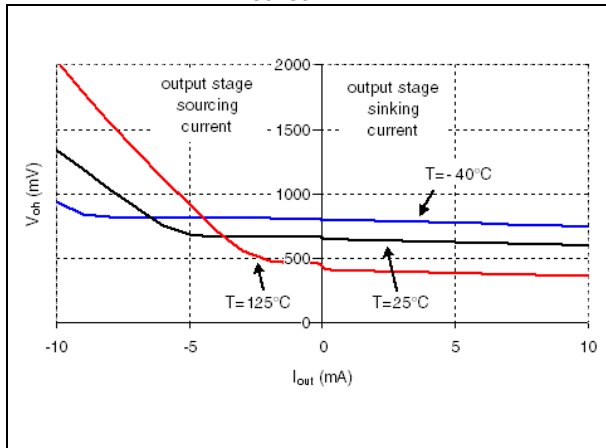

Figure 9. Output short-circuit source current versus temperature (Out pin connected to ground)

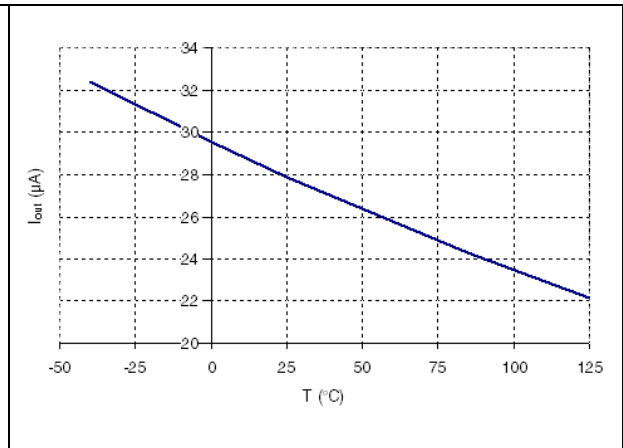

Figure 10. Output short-circuit sink current versus temperature (Out pin connected to V_{CC})

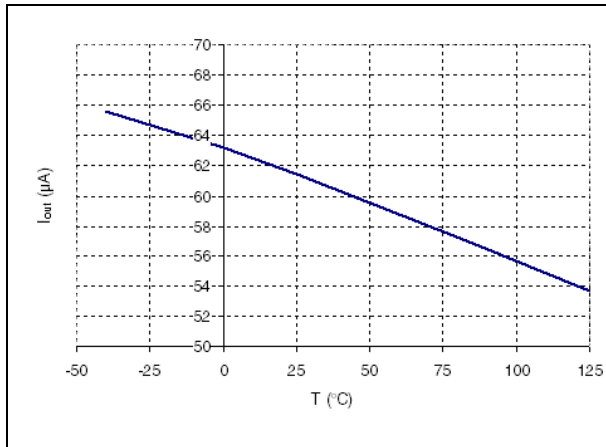

Figure 11. Output stage load regulation

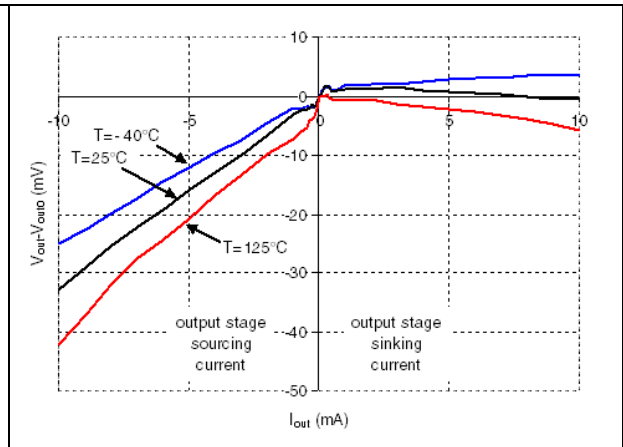

Figure 12. Input offset drift versus temperature

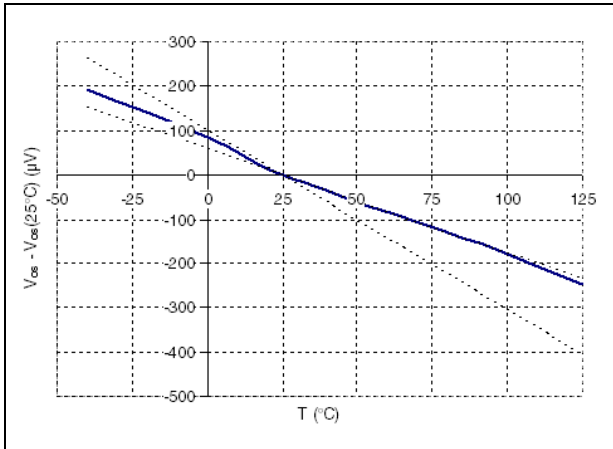

Figure 13. Output voltage drift versus temperature

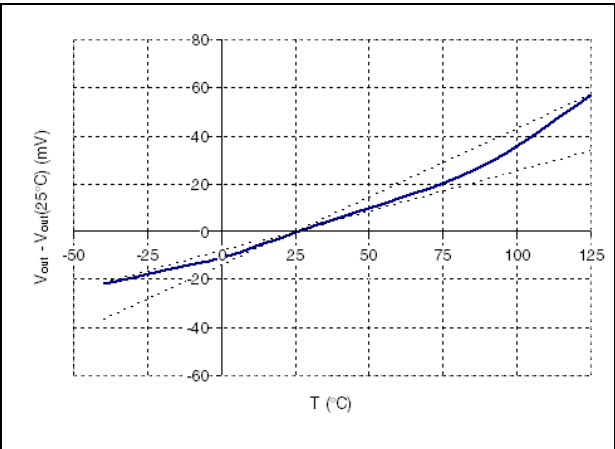

Figure 14. Bode diagram ($V_{sense}=100\text{mV}$)

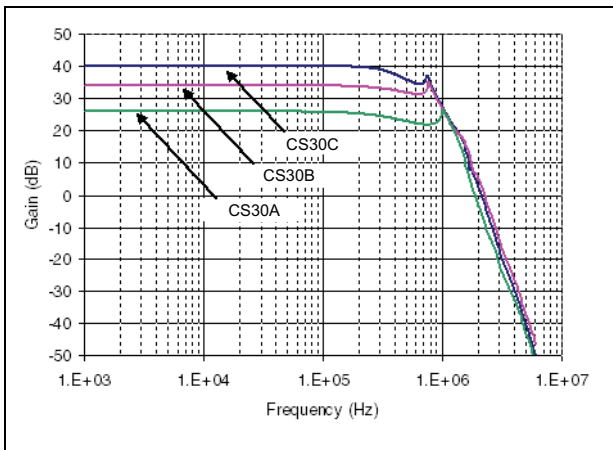

Figure 15. Power-supply rejection ratio versus frequency

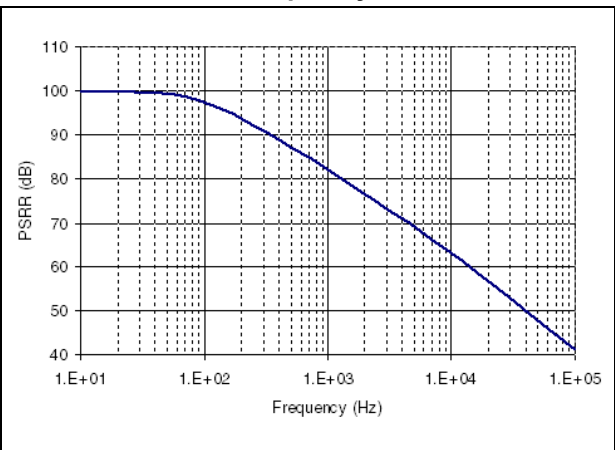

Figure 16. Total output voltage accuracy versus V_{sense}

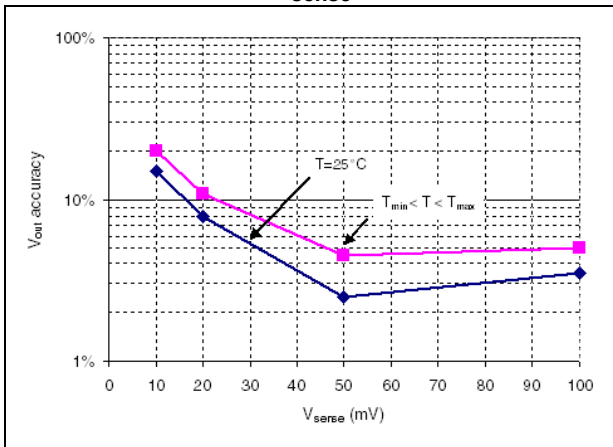

Figure 17. Output voltage versus V_{sense}

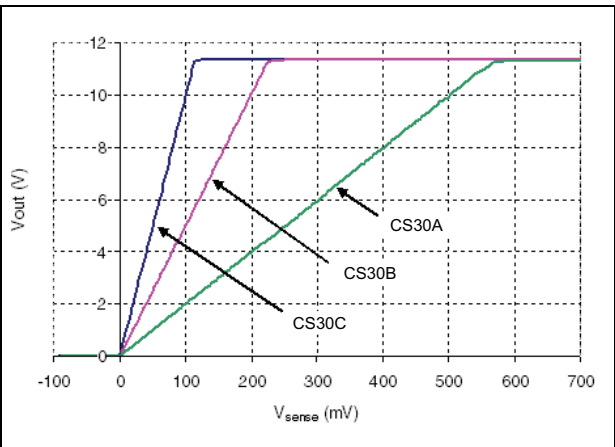

Figure 18. Output voltage versus V_{sense} (detail for low V_{sense} values)

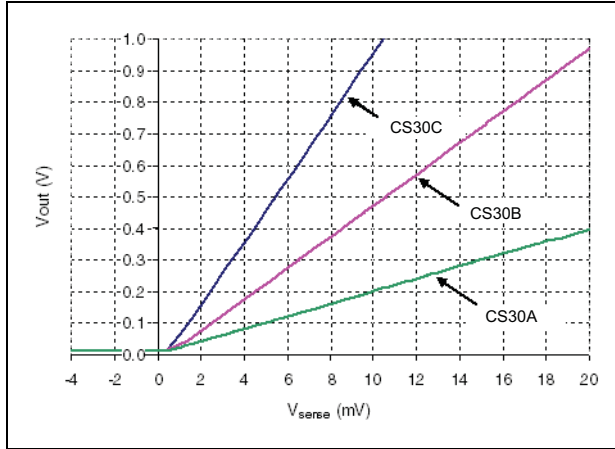
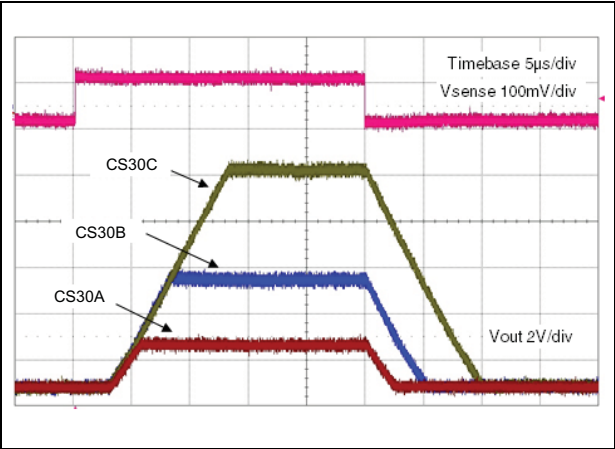

Figure 19. Step response



4 Parameter definitions

4.1 Common mode rejection ratio (CMR)

The common-mode rejection ratio (CMR) measures the ability of the current-sensing amplifier to reject any DC voltage applied on both inputs V_p and V_m . The CMR is referred back to the input so that its effect can be compared with the applied differential signal. The CMR is defined by the formula:

$$\text{CMR} = -20 \cdot \log \frac{\Delta V_{\text{out}}}{\Delta V_{\text{icm}} \cdot A_v}$$

4.2 Supply voltage rejection ratio (SVR)

The supply-voltage rejection ratio (SVR) measures the ability of the current-sensing amplifier to reject any variation of the supply voltage V_{CC} . The SVR is referred back to the input so that its effect can be compared with the applied differential signal. The SVR is defined by the formula:

$$\text{SVR} = -20 \cdot \log \frac{\Delta V_{\text{out}}}{\Delta V_{CC} \cdot A_v}$$

4.3 Gain (A_v) and input offset voltage (V_{os})

The input offset voltage is defined as the intersection between the linear regression of the V_{out} versus V_{sense} curve with the X-axis (see [Figure 20](#)). If V_{out1} is the output voltage with $V_{\text{sense1}}=50\text{mV}$ and V_{out2} is the output voltage with $V_{\text{sense2}}=5\text{mV}$, then V_{os} can be calculated with the following formula:

$$V_{os} = V_{\text{sense1}} - \left(\frac{V_{\text{sense1}} - V_{\text{sense2}}}{V_{\text{out1}} - V_{\text{out2}}} \cdot V_{\text{out1}} \right)$$

The amplification gain A_v is defined as the ratio between output voltage and input differential voltage:

$$A_v = \frac{V_{\text{out}}}{V_{\text{sense}}}$$

Figure 20. V_{out} versus V_{sense} characteristics: detail for low V_{sense} values

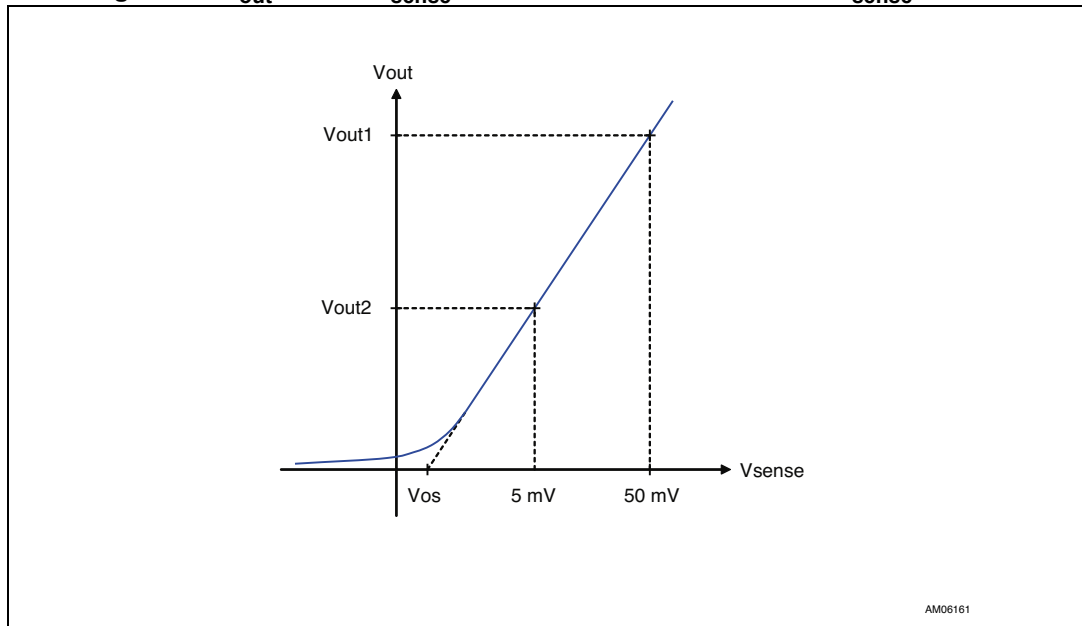

AM06161

4.4 Output voltage drift versus temperature

The output voltage drift versus temperature is defined as the maximum variation of V_{out} with respect to its value at 25°C , over the temperature range. It is calculated as follows:

$$\frac{\Delta V_{out}}{\Delta T} = \max \frac{V_{out}(T_{amb}) - V_{out}(25^\circ\text{C})}{T_{amb} - 25^\circ\text{C}}$$

with $T_{min} < T_{amb} < T_{max}$.

Figure 21 provides a graphical definition of output voltage drift versus temperature. On this chart, V_{out} is always comprised in the area defined by dotted lines representing the maximum and minimum variation of V_{out} versus T .

Figure 21. Output voltage drift versus temperature

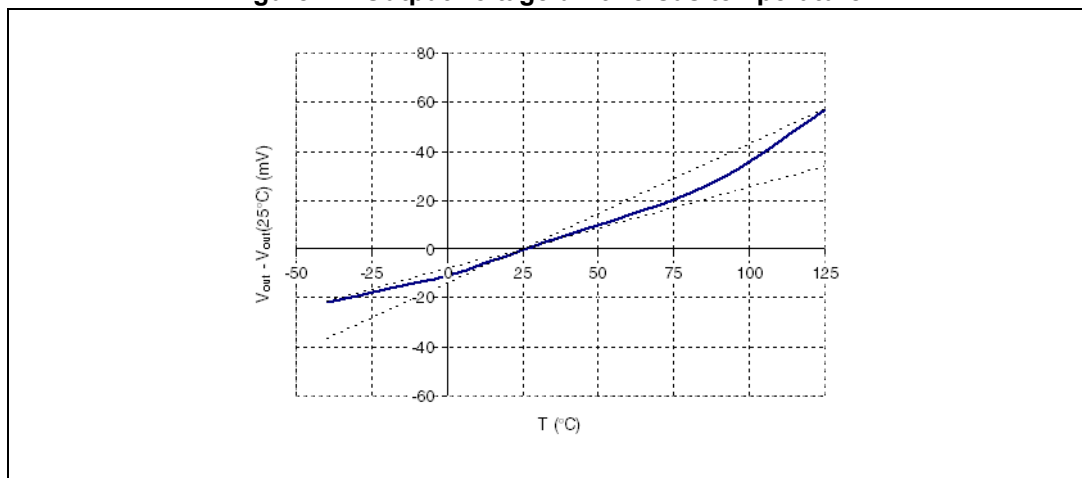

4.5 Output voltage accuracy

The output voltage accuracy is the difference between the actual output voltage and the theoretical output voltage. Ideally, the current sensing output voltage should be equal to the input differential voltage multiplied by the theoretical gain, as in the following formula:

$$V_{out-th} = A_v \cdot V_{sense}$$

The actual value is very slightly different, mainly due to the effects of:

- the input offset voltage V_{os} ,
- non-linearity

Figure 22. V_{out} vs. V_{sense} theoretical and actual characteristics

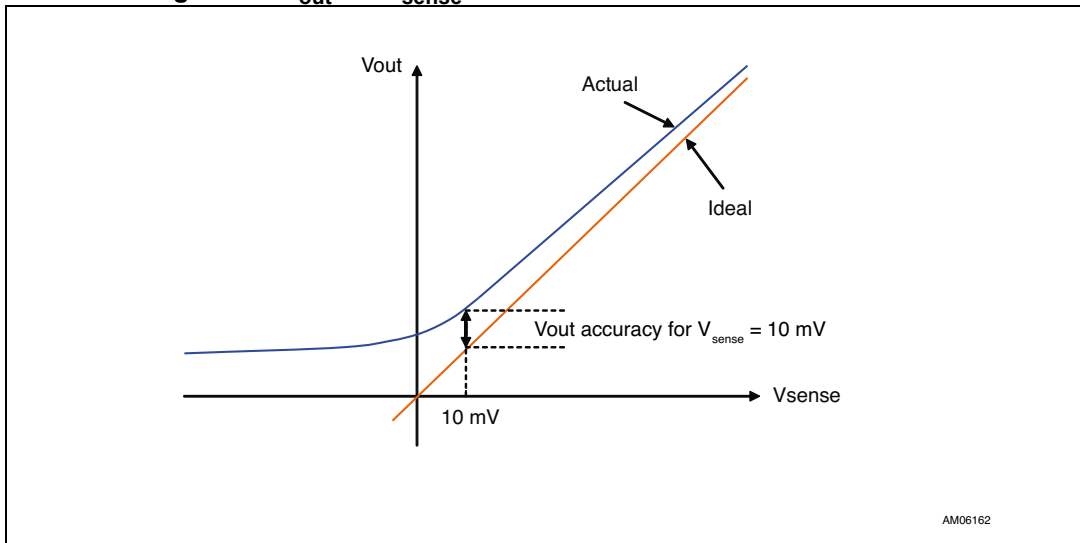

The output voltage accuracy, expressed in percentage, can be calculated with the following formula:

$$\Delta V_{out} = \frac{\text{abs}(V_{out} - (A_v \cdot V_{sense}))}{A_v \cdot V_{sense}}$$

with $A_v = 20 \text{ V/V}$ for CS30A, $A_v = 50 \text{ V/V}$ for CS30B and $A_v = 100 \text{ V/V}$ for CS30C.

5 Application information

The CS30 can be used to measure current and to feed back the information to a microcontroller, as shown in [Figure 23](#).

Figure 23. Typical application schematic

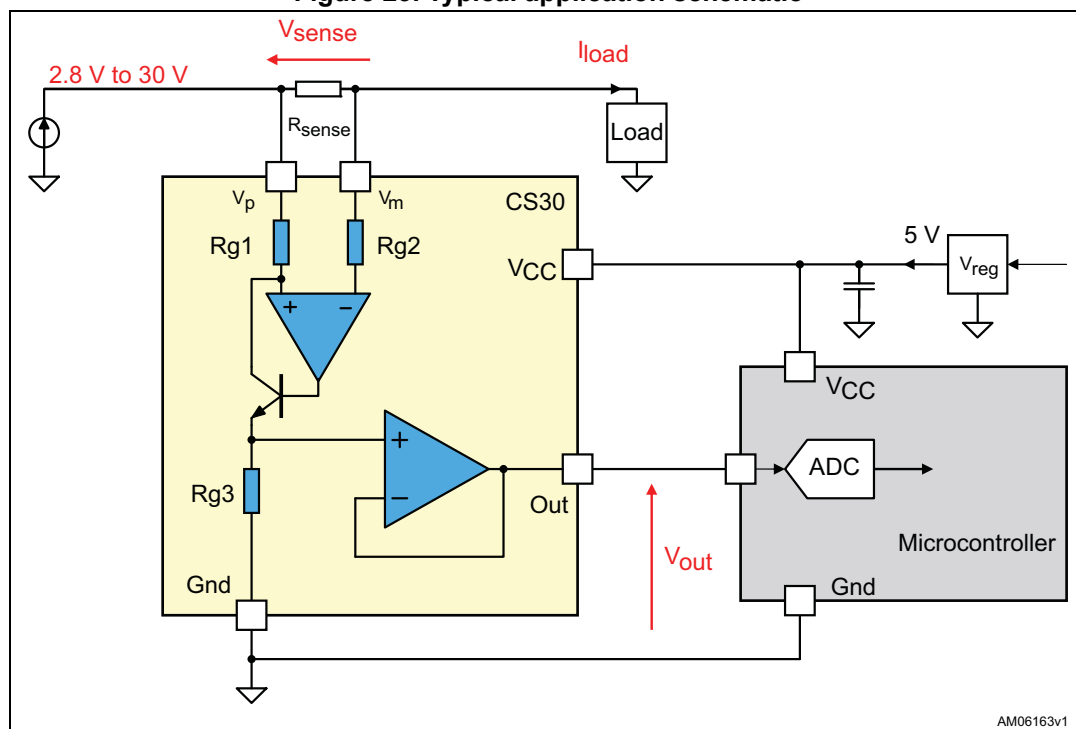

The current from the supply flows to the load through the R_{sense} resistor causing a voltage drop equal to V_{sense} across R_{sense} . The amplifier input currents are negligible, therefore its inverting input voltage is equal to V_m . The amplifier's open-loop gain forces its non-inverting input to the same voltage as the inverting input. As a consequence, the amplifier adjusts current flowing through R_{g1} so that the voltage drop across R_{g1} exactly matches V_{sense} .

Therefore, the drop across R_{g1} is: $V_{R_{g1}} = V_{sense} = R_{sense} \cdot I_{load}$

If $I_{R_{g1}}$ is the current flowing through R_{g1} , then $I_{R_{g1}}$ is given by the formula: $I_{R_{g1}} = V_{sense} / R_{g1}$

The $I_{R_{g1}}$ current flows entirely into resistor R_{g3} (the input bias current of the buffer is negligible). Therefore, the voltage drop on the R_{g3} resistor can be calculated as follows:

$$V_{R_{g3}} = R_{g3} \cdot I_{R_{g1}} = (R_{g3} / R_{g1}) \cdot V_{sense}$$

Because the voltage across the R_{g3} resistor is buffered to the Out pin, V_{out} can be expressed as:

$$V_{out} = (R_{g3} / R_{g1}) \cdot V_{sense} \text{ or } V_{out} = (R_{g3} / R_{g1}) \cdot R_{sense} \cdot I_{load}$$

The resistor ratio R_{g3} / R_{g1} is internally set to 20V/V for CS30A, to 50V/V for CS30B and to 100V/V for CS30C.

The R_{sense} resistor and the R_{g3} / R_{g1} resistor ratio (equal to A_v) are important parameters because they define the full scale output range of your application. Therefore, they must be selected carefully.

6 Package information

In order to meet environmental requirements, ST offers these devices in different grades of ECOPACK® packages, depending on their level of environmental compliance. ECOPACK® specifications, grade definitions and product status are available at: www.st.com. ECOPACK® is an ST trademark.

Figure 24. SOT23-5L package mechanical drawing

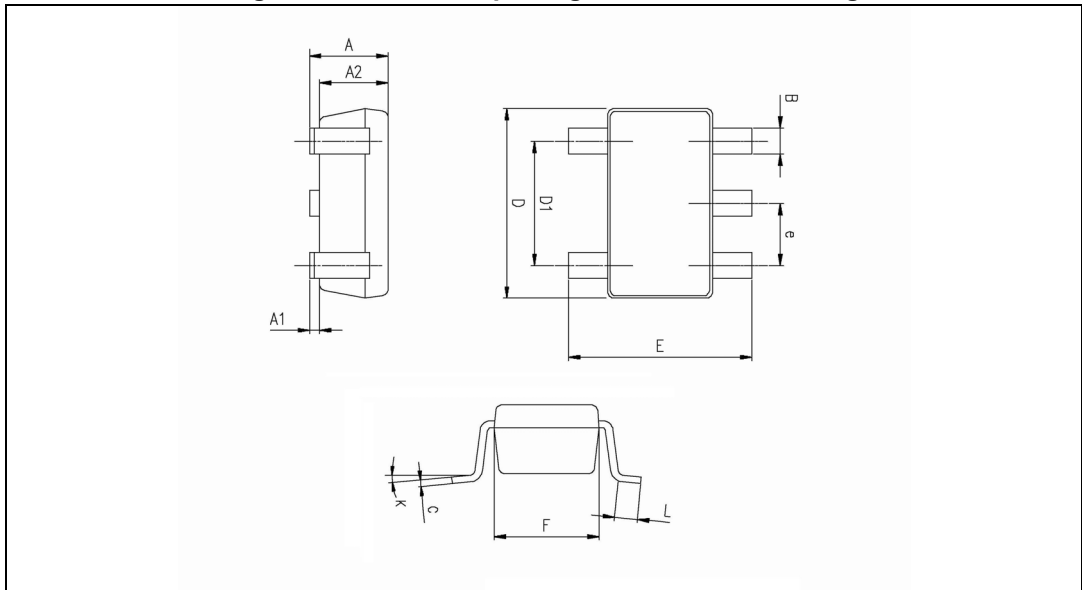

Table 10. SOT23-5L package mechanical data

| Ref. | Dimensions | | | | | |
|------|-------------|------|------------|--------|-------|-------|
| | Millimeters | | | Inches | | |
| | Min. | Typ. | Max. | Min. | Typ. | Max. |
| A | 0.90 | 1.20 | 1.45 | 0.035 | 0.047 | 0.057 |
| A1 | | | 0.15 | | | 0.006 |
| A2 | 0.90 | 1.05 | 1.30 | 0.035 | 0.041 | 0.051 |
| B | 0.35 | 0.40 | 0.50 | 0.013 | 0.015 | 0.019 |
| C | 0.09 | 0.15 | 0.20 | 0.003 | 0.006 | 0.008 |
| D | 2.80 | 2.90 | 3.00 | 0.110 | 0.114 | 0.118 |
| D1 | | 1.90 | | | 0.075 | |
| e | | 0.95 | | | 0.037 | |
| E | 2.60 | 2.80 | 3.00 | 0.102 | 0.110 | 0.118 |
| F | 1.50 | 1.60 | 1.75 | 0.059 | 0.063 | 0.069 |
| L | 0.10 | 0.35 | 0.60 | 0.004 | 0.013 | 0.023 |
| K | 0 degrees | | 10 degrees | | | |

7 Revision history

Table 11. Document revision history

| Date | Revision | Changes |
|-------------|----------|-----------------|
| 06-Mar-2014 | 1 | Initial release |

Please Read Carefully:

Information in this document is provided solely in connection with ST products. STMicroelectronics NV and its subsidiaries ("ST") reserve the right to make changes, corrections, modifications or improvements, to this document, and the products and services described herein at any time, without notice.

All ST products are sold pursuant to ST's terms and conditions of sale.

Purchasers are solely responsible for the choice, selection and use of the ST products and services described herein, and ST assumes no liability whatsoever relating to the choice, selection or use of the ST products and services described herein.

No license, express or implied, by estoppel or otherwise, to any intellectual property rights is granted under this document. If any part of this document refers to any third party products or services it shall not be deemed a license grant by ST for the use of such third party products or services, or any intellectual property contained therein or considered as a warranty covering the use in any manner whatsoever of such third party products or services or any intellectual property contained therein.

UNLESS OTHERWISE SET FORTH IN ST'S TERMS AND CONDITIONS OF SALE ST DISCLAIMS ANY EXPRESS OR IMPLIED WARRANTY WITH RESPECT TO THE USE AND/OR SALE OF ST PRODUCTS INCLUDING WITHOUT LIMITATION IMPLIED WARRANTIES OF MERCHANTABILITY, FITNESS FOR A PARTICULAR PURPOSE (AND THEIR EQUIVALENTS UNDER THE LAWS OF ANY JURISDICTION), OR INFRINGEMENT OF ANY PATENT, COPYRIGHT OR OTHER INTELLECTUAL PROPERTY RIGHT.

ST PRODUCTS ARE NOT DESIGNED OR AUTHORIZED FOR USE IN: (A) SAFETY CRITICAL APPLICATIONS SUCH AS LIFE SUPPORTING, ACTIVE IMPLANTED DEVICES OR SYSTEMS WITH PRODUCT FUNCTIONAL SAFETY REQUIREMENTS; (B) AERONAUTIC APPLICATIONS; (C) AUTOMOTIVE APPLICATIONS OR ENVIRONMENTS, AND/OR (D) AEROSPACE APPLICATIONS OR ENVIRONMENTS. WHERE ST PRODUCTS ARE NOT DESIGNED FOR SUCH USE, THE PURCHASER SHALL USE PRODUCTS AT PURCHASER'S SOLE RISK, EVEN IF ST HAS BEEN INFORMED IN WRITING OF SUCH USAGE, UNLESS A PRODUCT IS EXPRESSLY DESIGNATED BY ST AS BEING INTENDED FOR "AUTOMOTIVE, AUTOMOTIVE SAFETY OR MEDICAL" INDUSTRY DOMAINS ACCORDING TO ST PRODUCT DESIGN SPECIFICATIONS. PRODUCTS FORMALLY ESCC, QML OR JAN QUALIFIED ARE DEEMED SUITABLE FOR USE IN AEROSPACE BY THE CORRESPONDING GOVERNMENTAL AGENCY.

Resale of ST products with provisions different from the statements and/or technical features set forth in this document shall immediately void any warranty granted by ST for the ST product or service described herein and shall not create or extend in any manner whatsoever, any liability of ST.

ST and the ST logo are trademarks or registered trademarks of ST in various countries.

Information in this document supersedes and replaces all information previously supplied.

The ST logo is a registered trademark of STMicroelectronics. All other names are the property of their respective owners.

© 2014 STMicroelectronics - All rights reserved

STMicroelectronics group of companies

Australia - Belgium - Brazil - Canada - China - Czech Republic - Finland - France - Germany - Hong Kong - India - Israel - Italy - Japan - Malaysia - Malta - Morocco - Philippines - Singapore - Spain - Sweden - Switzerland - United Kingdom - United States of America

www.st.com