

50 ohm nominal input / conjugate match balun to CC1101 / CC1150 (868-928 MHz), with integrated harmonic filter

Datasheet – production data

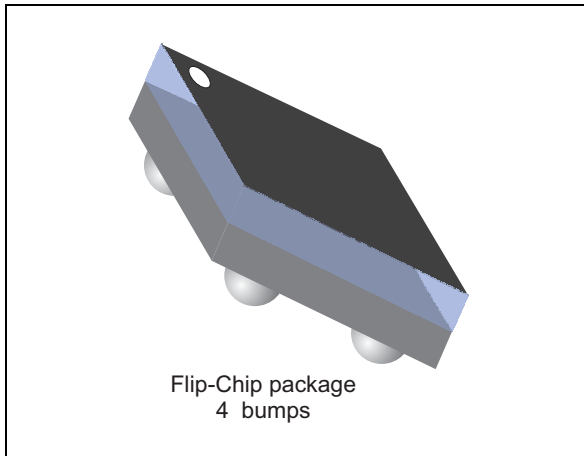

## Description

STMicroelectronics BAL-CC1101-01D3 is an ultra miniature balun which integrates a matching network in a monolithic glass substrate. This has been customized for the CC1101 / CC1150 TI transceiver.

It's a design using STMicroelectronics IPD (integrated passive device) technology on non-conductive glass substrate to optimize RF performance.

## Features

- 50  $\Omega$  nominal input / conjugate match to CC1101 / CC1150
- Low insertion loss
- Low amplitude imbalance
- Low phase imbalance
- Coated Flip-Chip on glass
- Small footprint: < 2.1 mm<sup>2</sup>

## Benefits

- Extremely low profile (< 550  $\mu\text{m}$  after reflow)
- High RF performance
- RF BOM and area reduction

Figure 1. Application schematic

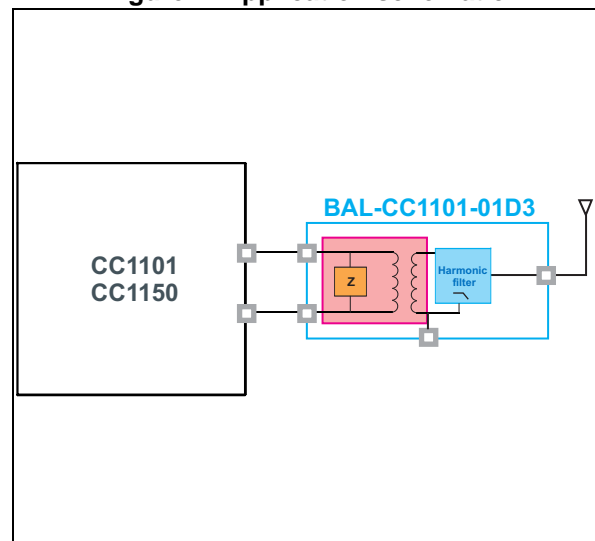

# 1 Characteristics

**Table 1. Absolute maximum rating (limiting values)**

Symbol	Parameter	Value	Unit
$P_{IN}$	Input power $RF_{IN}$	20	dBm
$V_{ESD}$	ESD ratings human body model (JESD22-A114C), all I/O one at a time while others connected to GND	2000	V
	ESD ratings machine model, all I/O	500	
	ESD ratings charged device model (JESD22-C101D)	500	
$T_{OP}$	Operating temperature	-40 to +125	°C

**Table 2. Electrical characteristics - RF performance ( $T_{amb} = 25\text{ °C}$ )**

Symbol	Parameter	Value			Unit
		Min.	Typ.	Max.	
$Z_{OUT}$	Nominal differential output impedance		Conjugate match to CC1101 / CC1150		$\Omega$
$Z_{IN}$	Nominal input impedance		50		
F	Frequency range (bandwidth)	779		928	MHz
$I_L$	Insertion loss in bandwidth		1.7	1.9	dB
$R_{L\_SE}$	Single ended return loss in bandwidth		15		dB
$R_{L\_DIFF}$	Differential ended return loss in bandwidth		15		dB
$\Phi_{imb}$	Phase imbalance	-10		10	°
$A_{imb}$	Amplitude imbalance	-1		1	dB
Att	Harmonic levels (TX filter)				dB
	Attenuation at 2fo		-25		
	Attenuation at 3fo		-50		

### 1.1 Measurements

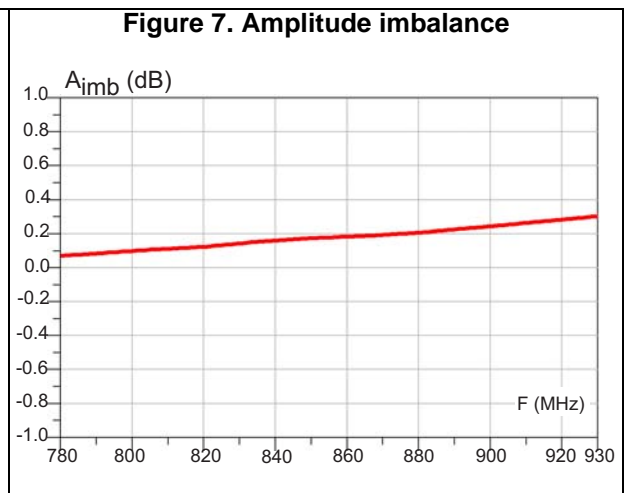
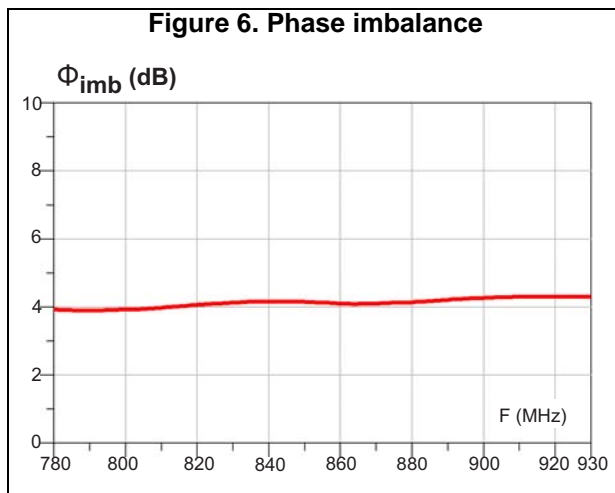
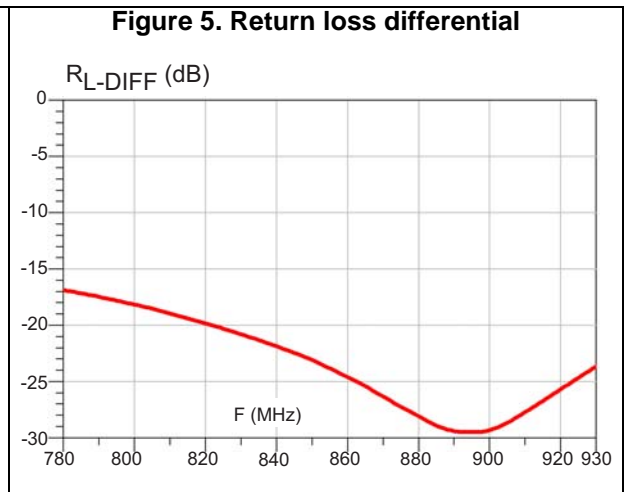
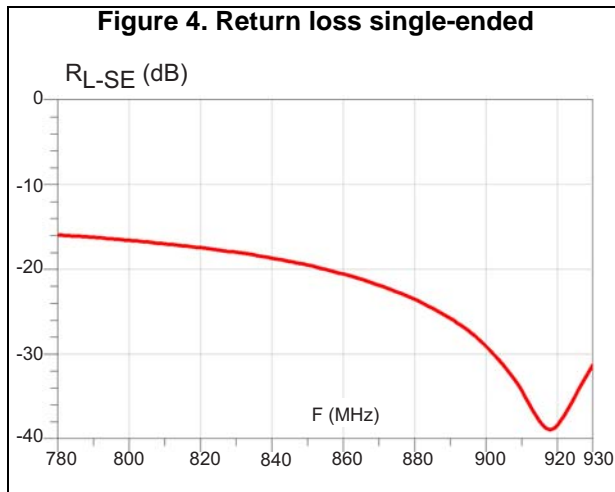
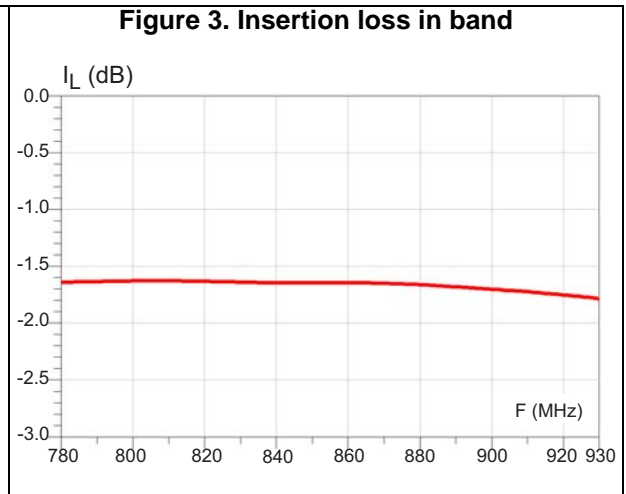
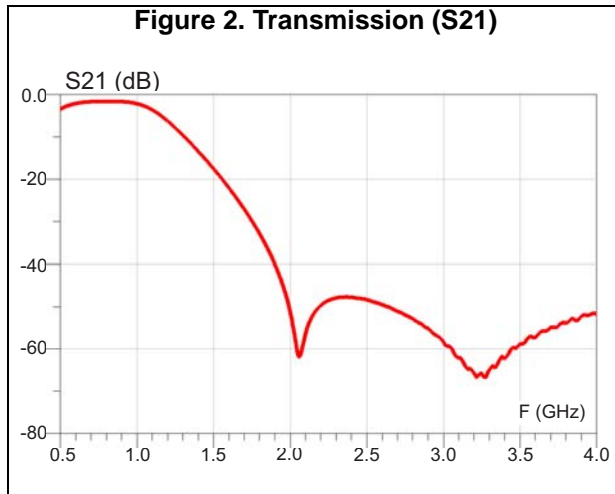

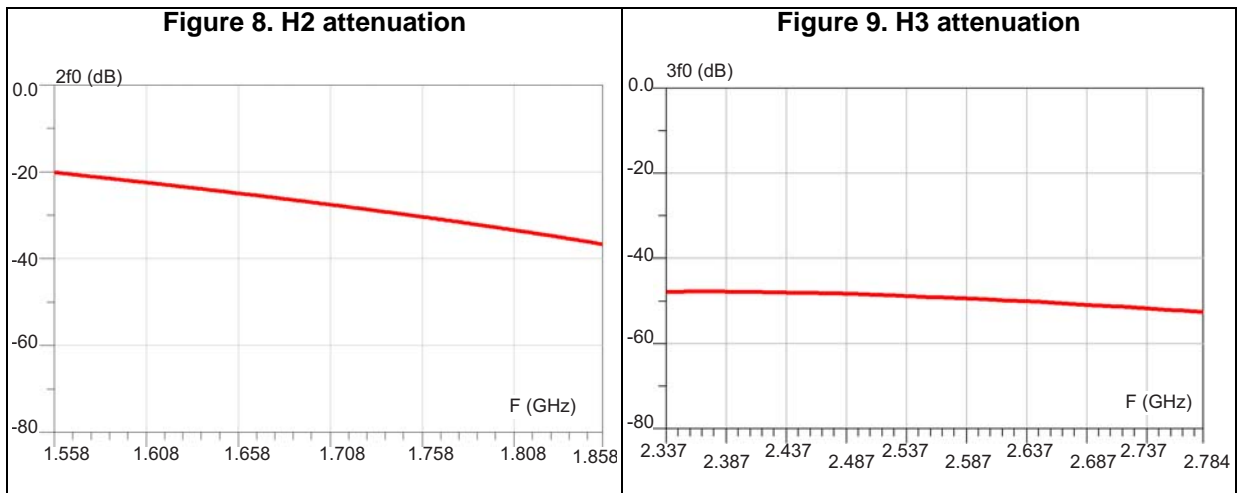

## 2 Package information

- Epoxy meets UL94, V0
- Lead-free package

In order to meet environmental requirements, ST offers these devices in different grades of ECOPACK<sup>®</sup> packages, depending on their level of environmental compliance. ECOPACK<sup>®</sup> specifications, grade definitions and product status are available at: [www.st.com](http://www.st.com). ECOPACK<sup>®</sup> is an ST trademark.

### 2.1 Flip-Chip package information

Figure 10. Flip-Chip package outline

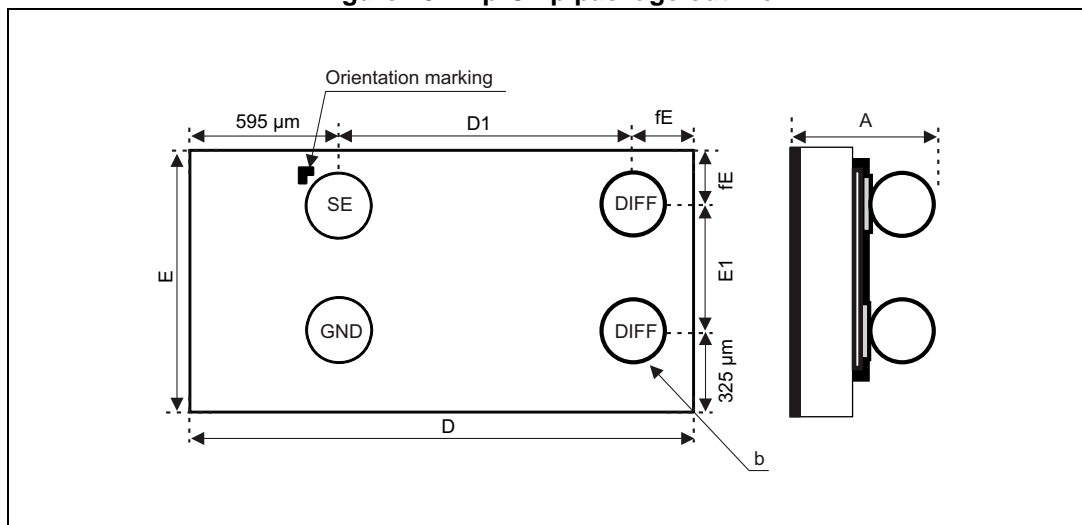

Table 3. Flip-Chip package mechanical data

Parameter	Description	Min.	Typ.	Max.	Unit
A	Bump height + substrate thickness	0.570	0.630	0.690	mm
b	Bump diameter	0.215	0.255	0.295	mm
D	Y dimension of the die	1.970	2.020	2.070	mm
D1	Y pitch		1.200		mm
E	X dimension of the die	1.000	1.050	1.100	mm
E1	X pitch		0.500		mm
fE	Distance from bump to edge of die on X axis			0.225	mm

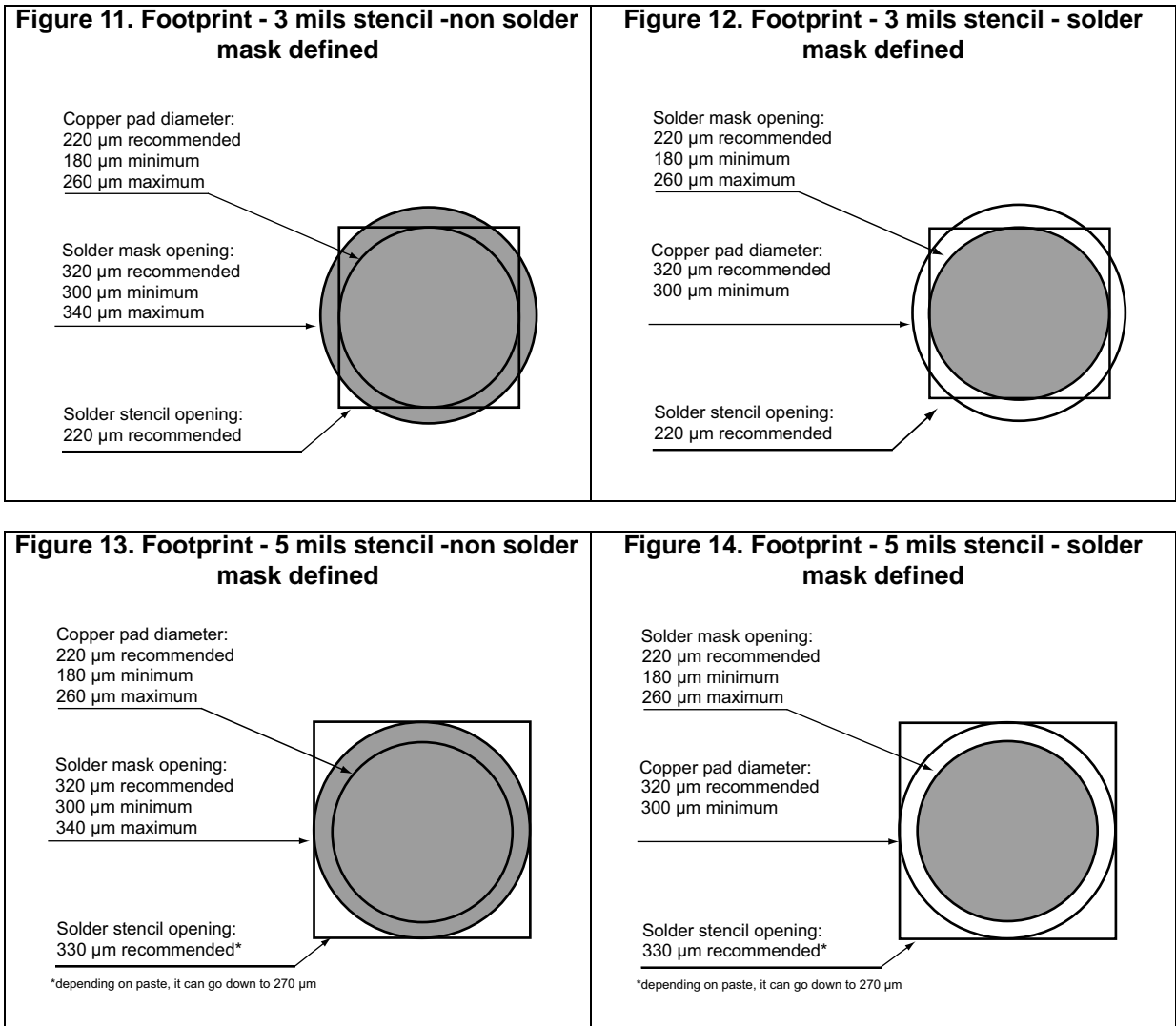

Figure 15. PCB view CC1101 with BAL-CC1101-01D3

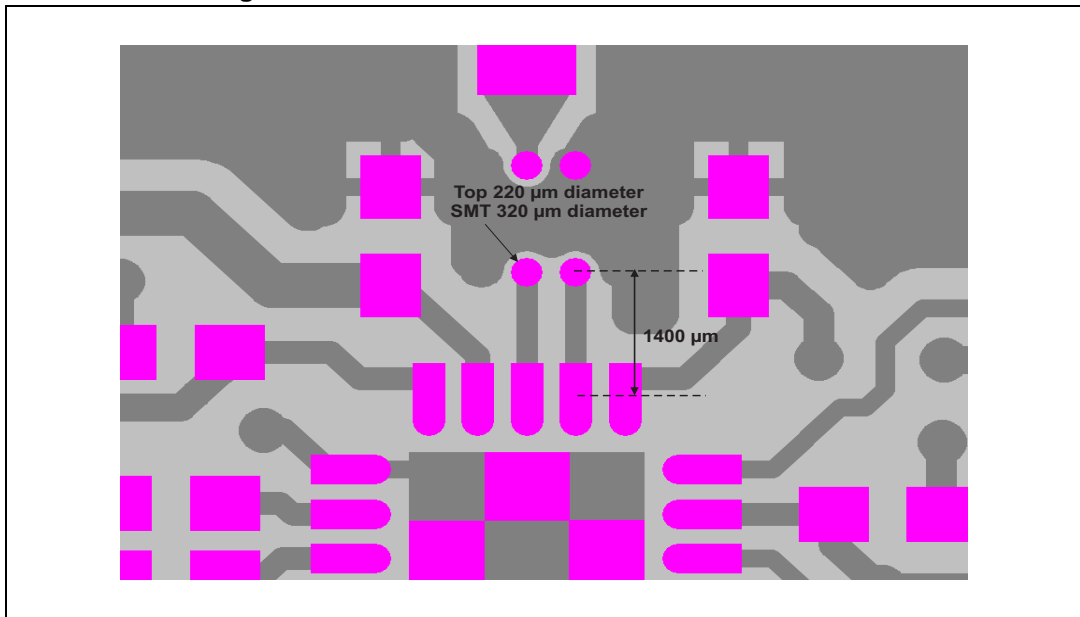

Figure 16. Marking

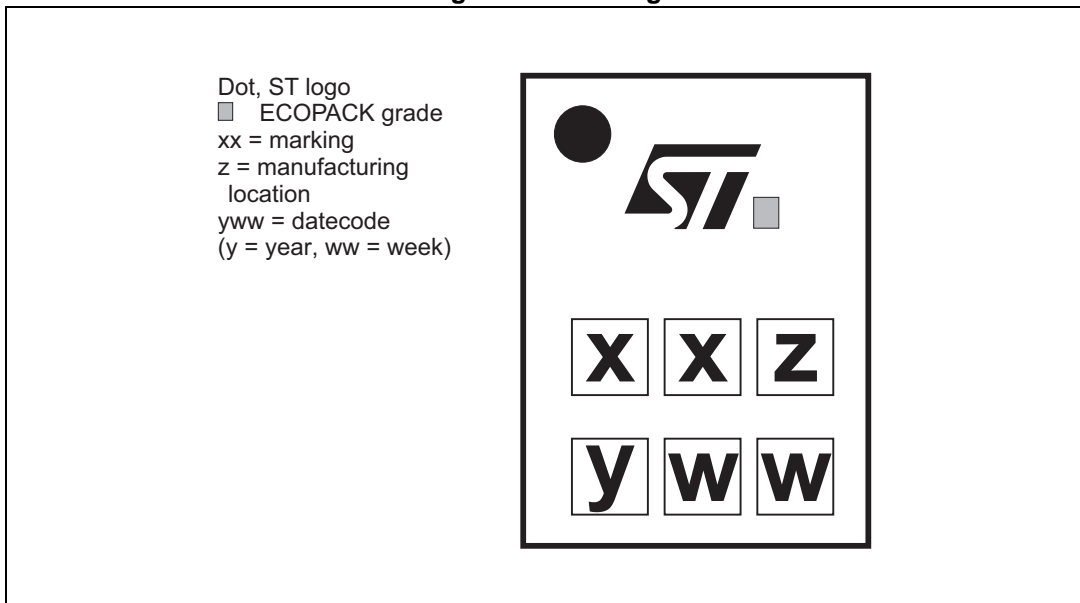
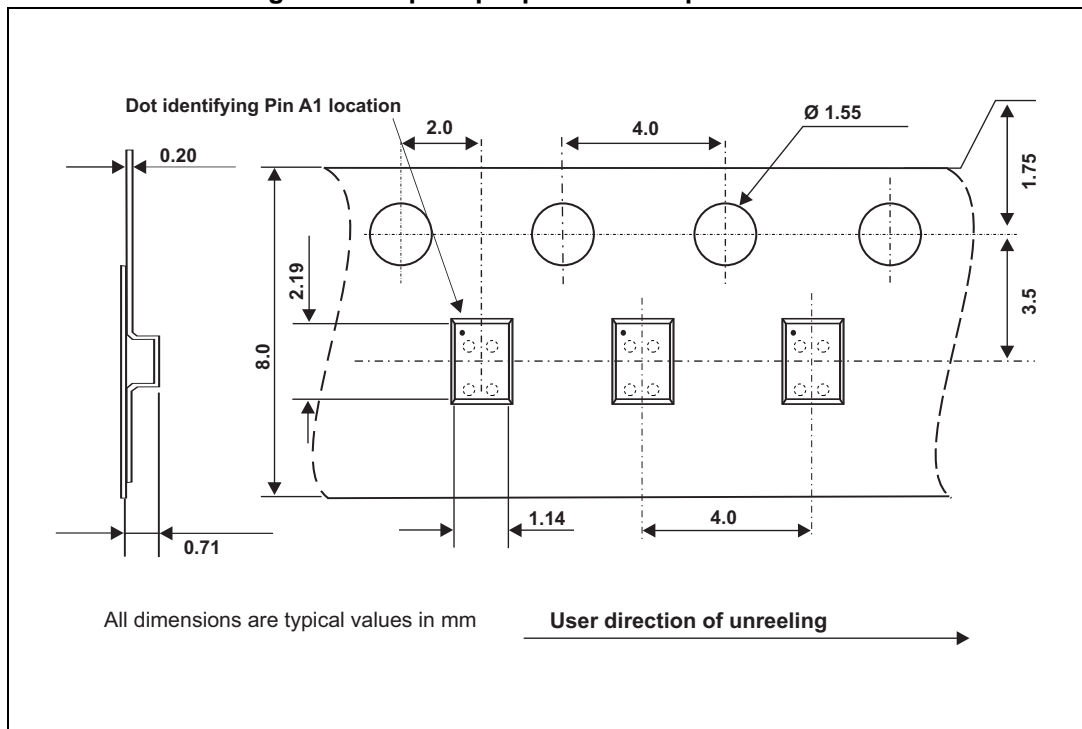

Figure 17. Flip Chip tape and reel specifications



Note: More information is available in the STMicroelectronics Application note: AN2348 Flip-Chip: "Package description and recommendations for use"



### 3 Ordering information

Table 4. Ordering information

Order code	Marking	Package	Weight	Base qty	Delivery mode
BAL-CC1101-01D3	SS	Flip-Chip	2.21 mg	5000	Tape and reel (7")

### 4 Revision history

Table 5. Document revision history

Date	Revision	Changes
23-Jan-2014	1	Initial release
18-Sep-2015	2	Updated Figure 10. Added Figure 11, Figure 12, Figure 13, Figure 14 and Table 3.
02-May-2016	3	Updated <a href="#">Figure 10</a> and <a href="#">Table 3</a> .

**IMPORTANT NOTICE – PLEASE READ CAREFULLY**

STMicroelectronics NV and its subsidiaries ("ST") reserve the right to make changes, corrections, enhancements, modifications, and improvements to ST products and/or to this document at any time without notice. Purchasers should obtain the latest relevant information on ST products before placing orders. ST products are sold pursuant to ST's terms and conditions of sale in place at the time of order acknowledgement.

Purchasers are solely responsible for the choice, selection, and use of ST products and ST assumes no liability for application assistance or the design of Purchasers' products.

No license, express or implied, to any intellectual property right is granted by ST herein.

Resale of ST products with provisions different from the information set forth herein shall void any warranty granted by ST for such product.

ST and the ST logo are trademarks of ST. All other product or service names are the property of their respective owners.

Information in this document supersedes and replaces information previously supplied in any prior versions of this document.

© 2016 STMicroelectronics – All rights reserved