

# Negative Voltage Hot Swap Controllers in SOT-23

## FEATURES

- Allows Safe Board Insertion and Removal from a Live  $-48V$  Backplane
- Floating Topology Permits Very High Voltage Operation
- Programmable Analog Current Limit with Circuit Breaker Timer
- Fast Response Time Limits Peak Fault Current
- Improved Ruggedness Shunt Regulator
- Programmable Timer
- Programmable Undervoltage/Overvoltage Protection
- Low Profile 6-Lead SOT-23 (ThinSOT™) Package

## APPLICATIONS

- Hot Board Insertion
- Electronic Circuit Breaker
- $-48V$  Distributed Power Systems
- Negative Power Supply Control
- Central Office Switching
- Programmable Current Limiting Circuit
- High Availability Servers
- Disk Arrays

## DESCRIPTION

The LTC4251B/LTC4251B-1/LTC4251B-2 negative voltage Hot Swap™ controllers allow a board to be safely inserted and removed from a live backplane. Output current is controlled by three stages of current limiting: a timed circuit breaker, active current limiting and a fast feedforward path that limits peak current under worst-case catastrophic fault conditions.

Programmable undervoltage and overvoltage detectors disconnect the load whenever the input supply exceeds the desired operating range. The supply input is shunt regulated, allowing safe operation with very high supply voltages. A multifunction timer delays initial start-up and controls the circuit breaker's response time.

The LTC4251B UV/OV thresholds are designed to match the standard telecom operating range of  $-43V$  to  $-75V$ . The LTC4251B-1 UV/OV thresholds extend the operating range to encompass  $-36V$  to  $-72V$ . The LTC4251B-2 implements a UV threshold of  $-43V$  only. The LTC4251B improves the ruggedness of the LTC4251 shunt regulator.

LT, LT, LTC, LTM, Linear Technology and the Linear logo are registered trademarks and Hot Swap and ThinSOT are trademarks of Linear Technology Corporation. All other trademarks are the property of their respective owners.

## TYPICAL APPLICATION

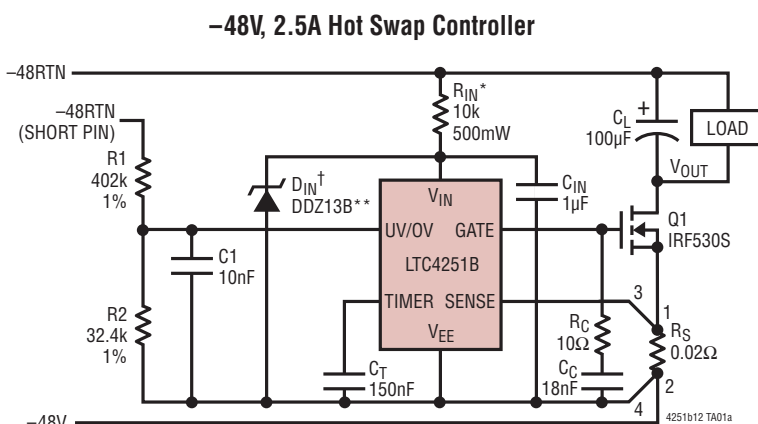

\*TWO 0.25W RESISTORS IN SERIES FOR  $R_{IN}$  ON THE PCB ARE RECOMMENDED.

\*\*DIODES, INC.

†RECOMMENDED FOR HARSH ENVIRONMENTS

### Start-Up Behavior

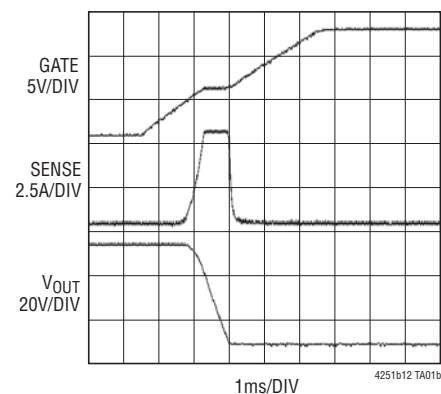

# LTC4251B/LTC4251B-1/ LTC4251B-2

## ABSOLUTE MAXIMUM RATINGS

(Note 1), All Voltages are Referred to  $V_{EE}$

Current into $V_{IN}$ (100 $\mu$ s Pulse)	100mA
Minimum $V_{IN}$ Voltage	-0.3V
Gate, UV/OV, Timer Voltage	-0.3V to 16V
Sense Voltage	-0.6V to 16V
Current Out of Sense Pin (20 $\mu$ s Pulse)	-200mA
Maximum Junction Temperature	125°C
Operating Temperature Range	
LTC4251BC/LTC4251BC-1/LTC4251BC-2	0°C to 70°C
LTC4251BI/LTC4251BI-1/LTC4251BI-2	-40°C to 85°C
Storage Temperature Range	-65°C to 150°C
Lead Temperature (Soldering, 10 sec)	300°C

## PIN CONFIGURATION

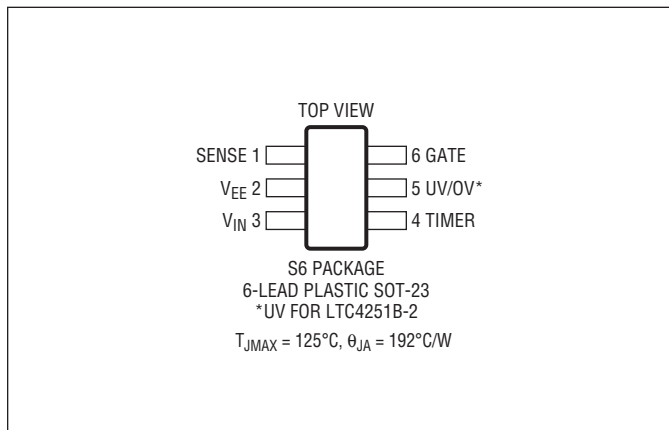

## ORDER INFORMATION

### Lead Free Finish

TAPE AND REEL (MINI)	TAPE AND REEL	PART MARKING*	PACKAGE DESCRIPTION	TEMPERATURE RANGE
LTC4251BCS6#TRMPBF	LTC4251BCS6#TRPBF	LTGCT	6-Lead Plastic SOT-23	0°C to 70°C
LTC4251BIS6#TRMPBF	LTC4251BIS6#TRPBF	LTGCT	6-Lead Plastic SOT-23	-40°C to 85°C
LTC4251BCS6-1#TRMPBF	LTC4251BCS6-1#TRPBF	LTGDV	6-Lead Plastic SOT-23	0°C to 70°C
LTC4251BIS6-1#TRMPBF	LTC4251BIS6-1#TRPBF	LTGDV	6-Lead Plastic SOT-23	-40°C to 85°C
LTC4251BCS6-2#TRMPBF	LTC4251BCS6-2#TRPBF	LTGDW	6-Lead Plastic SOT-23	0°C to 70°C
LTC4251BIS6-2#TRMPBF	LTC4251BIS6-2#TRPBF	LTGDW	6-Lead Plastic SOT-23	-40°C to 85°C

TRM = 500 pieces. \*Temperature grades are identified by a label on the shipping container.

Consult LTC Marketing for parts specified with wider operating temperature ranges.

Consult LTC Marketing for information on lead based finish parts.

For more information on lead free part marking, go to: <http://www.linear.com/leadfree/>

For more information on tape and reel specifications, go to: <http://www.linear.com/tapeandree/>

## ELECTRICAL CHARACTERISTICS

The ● denotes the specifications which apply over the full operating temperature range, otherwise specifications are at  $T_A = 25^\circ\text{C}$ . (Notes 2, 3)

SYMBOL	PARAMETER	CONDITIONS	MIN	TYP	MAX	UNITS	
$V_Z$	$V_{IN}$ to $V_{EE}$ Zener Voltage	$I_{IN} = 2\text{mA}$	● 11.5	13	14.5	V	
$r_Z$	$V_{IN}$ to $V_{EE}$ Zener Dynamic Impedance	$I_{IN} = 2\text{mA}$ to 30mA		5		$\Omega$	
$I_{IN}$	$V_{IN}$ Supply Current	UV/OV = 4V, $V_{IN} = (V_Z - 0.3\text{V})$	●	0.8	2	mA	
$V_{LKO}$	$V_{IN}$ Undervoltage Lockout	Coming Out of UVLO (Rising $V_{IN}$ )	●	9.2	11.5	V	
$V_{LKH}$	$V_{IN}$ Undervoltage Lockout Hysteresis			1		V	
$V_{CB}$	Circuit Breaker Current Limit Voltage	$V_{CB} = (V_{SENSE} - V_{EE})$	●	40	50	60	mV
$V_{ACL}$	Analog Current Limit Voltage	$V_{ACL} = (V_{SENSE} - V_{EE})$	●	80	100	120	mV
$V_{FCL}$	Fast Current Limit Voltage	$V_{FCL} = (V_{SENSE} - V_{EE})$	●	150	200	300	mV
$I_{GATE}$	GATE Pin Output Current	UV/OV = 4V, $V_{SENSE} = V_{EE}$ , $V_{GATE} = 0\text{V}$ (Sourcing) UV/OV = 4V, $V_{SENSE} - V_{EE} = 0.15\text{V}$ , $V_{GATE} = 3\text{V}$ (Sinking) UV/OV = 4V, $V_{SENSE} - V_{EE} = 0.3\text{V}$ , $V_{GATE} = 1\text{V}$ (Sinking)	●	40 17 190	58	80	$\mu\text{A}$ mA mA
$V_{GATE}$	External MOSFET Gate Drive	$V_{GATE} - V_{EE}$ , $I_{IN} = 2\text{mA}$	●	10	12	$V_Z$	V

4251b12f

## ELECTRICAL CHARACTERISTICS

The ● denotes the specifications which apply over the full operating temperature range, otherwise specifications are at  $T_A = 25^\circ\text{C}$ .

SYMBOL	PARAMETER	CONDITIONS	MIN	TYP	MAX	UNITS
$V_{GATEL}$	Gate Low Threshold	(Before Gate Ramp-Up)		0.5		V
$V_{UVHI}$	UV Threshold High	LTC4251B/LTC4251B-2	● 3.075	3.225	3.375	V
		LTC4251B-1	● 2.300	2.420	2.540	V
$V_{UVLO}$	UV Threshold Low	LTC4251B/LTC4251B-2	● 2.775	2.925	3.075	V
		LTC4251B-1	● 2.050	2.160	2.270	V
$V_{UVHST}$	UV Hysteresis	LTC4251B/LTC4251B-2		0.30		V
		LTC4251B-1		0.26		V
$V_{OVHI}$	OV Threshold High	LTC4251B	● 5.85	6.15	6.45	V
		LTC4251B-1	● 5.86	6.17	6.48	V
$V_{OVLO}$	OV Threshold Low	LTC4251B	● 5.25	5.55	5.85	V
		LTC4251B-1	● 5.61	5.91	6.21	V
$V_{OVHST}$	OV Hysteresis	LTC4251B		0.60		V
		LTC4251B-1		0.26		V
$I_{SENSE}$	SENSE Input Current	UV/OV = 4V, $V_{SENSE} = 50\text{mV}$	● -30	-15		$\mu\text{A}$
$I_{INP}$	UV/OV Input Current	UV/OV = 4V	●	$\pm 0.1$	$\pm 1$	$\mu\text{A}$
$V_{TMRH}$	Timer Voltage High Threshold			4		V
$V_{TMRL}$	Timer Voltage Low Threshold			1		V
$I_{TMR}$	Timer Current	Timer On (Initial Cycle, Sourcing), $V_{TMR} = 2\text{V}$		5.8		$\mu\text{A}$
		Timer Off (Initial Cycle, Sinking), $V_{TMR} = 2\text{V}$		28		$\text{mA}$
		Timer On (Circuit Breaker, Sourcing), $V_{TMR} = 2\text{V}$		230		$\mu\text{A}$
		Timer Off (Cooling Cycle, Sinking), $V_{TMR} = 2\text{V}$		5.8		$\mu\text{A}$
$t_{PLLUG}$	UV Low to GATE Low			0.7		$\mu\text{s}$
$t_{PHLOG}$	OV High to GATE Low	LTC4251B/LTC4251B-1		1		$\mu\text{s}$

**Note 1:** Stresses beyond those listed under Absolute Maximum Ratings may cause permanent damage to the device. Exposure to any Absolute Maximum Rating condition for extended periods may affect device reliability and lifetime.

**Note 2:** All currents into device pins are positive; all currents out of device pins are negative. All voltages are referenced to  $V_{EE}$  unless otherwise specified.

**Note 3:** UV/OV = 4V refers to UV = 4V for the LTC4251B-2.

## TYPICAL PERFORMANCE CHARACTERISTICS

UV/OV = 4V refers to UV = 4V for the LTC4251B-2.

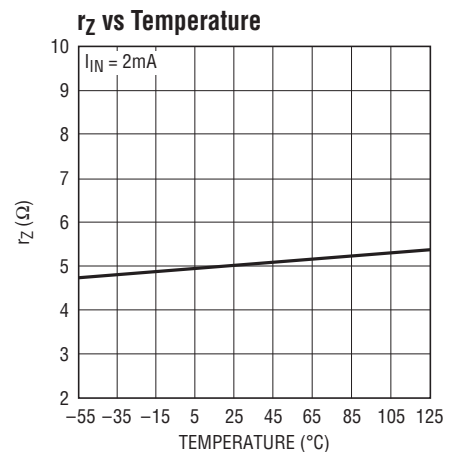
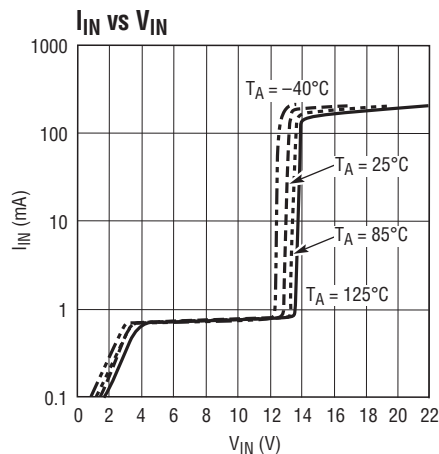
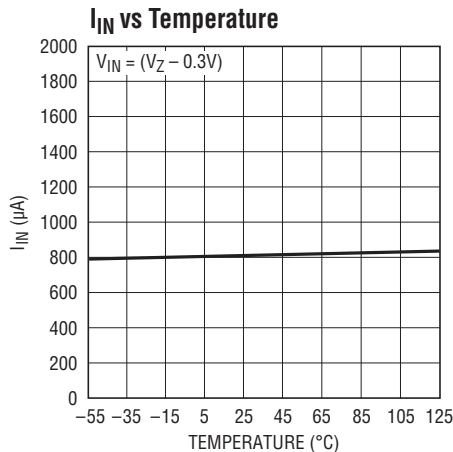

# LTC4251B/LTC4251B-1/ LTC4251B-2

## TYPICAL PERFORMANCE CHARACTERISTICS UV/OV = 4V refers to UV = 4V for the LTC4251B-2.

**$V_Z$  vs Temperature**

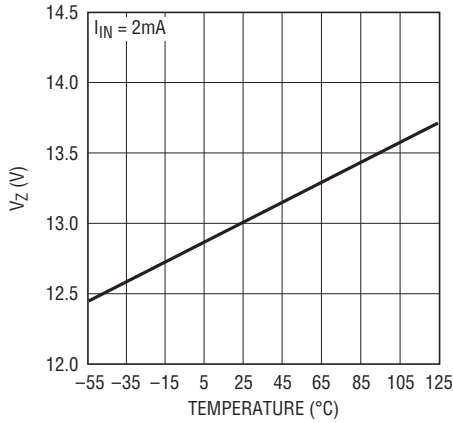

4251b12 G04

**Undervoltage Lockout  $V_{LKO}$  vs Temperature**

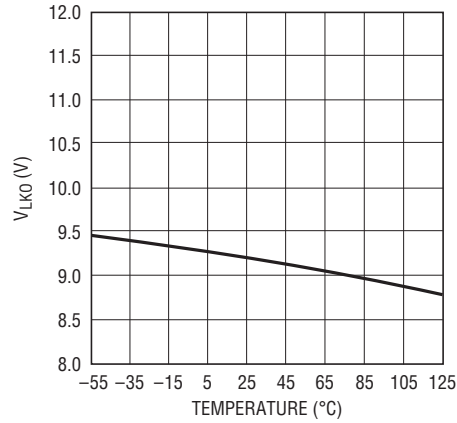

4251b12 G05

**Undervoltage Lockout Hysteresis  $V_{LKH}$  vs Temperature**

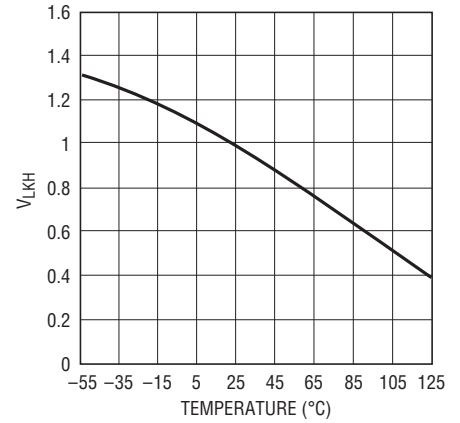

4251b12 G06

**Circuit Breaker Current Limit Voltage  $V_{CB}$  vs Temperature**

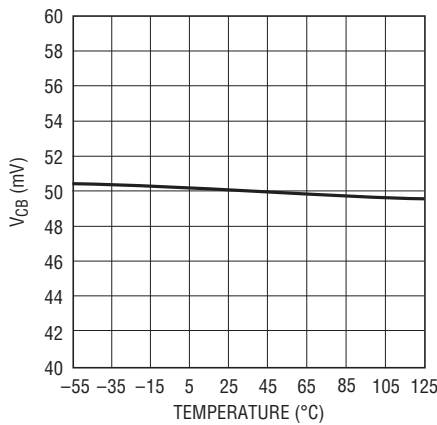

4251b12 G07

**Analog Current Limit Voltage  $V_{ACL}$  vs Temperature**

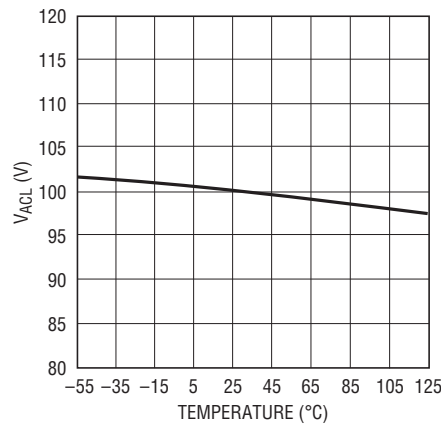

4251b12 G08

**Fast Current Limit Voltage  $V_{FCL}$  vs Temperature**

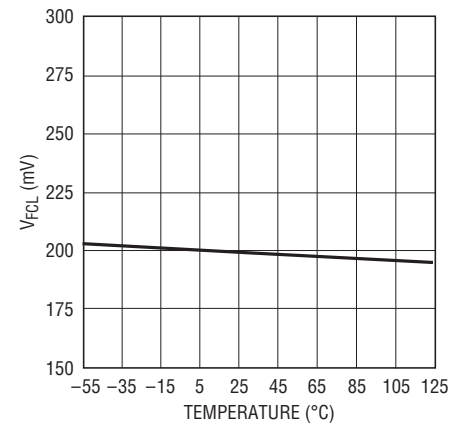

4251b12 G09

**$I_{GATE}$  (Source) vs Temperature**

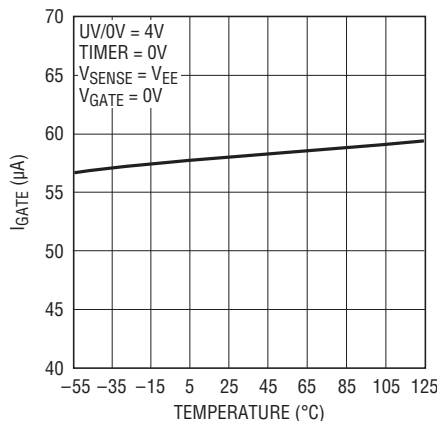

4251b12 G10

**$I_{GATE}$  (ACL, Sink) vs Temperature**

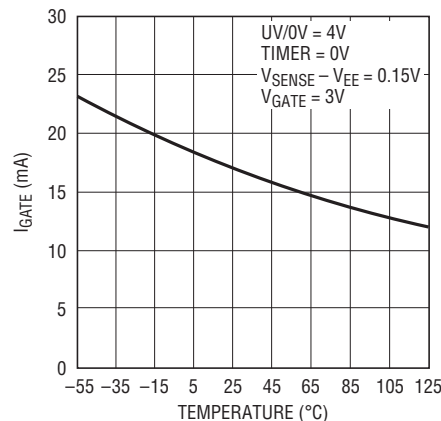

4251b12 G11

**$I_{GATE}$  (FCL, Sink) vs Temperature**

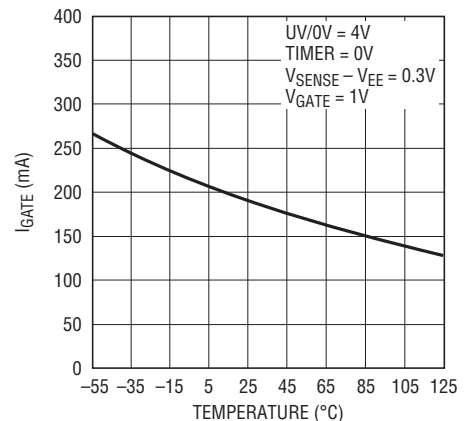

4251b12 G12

4251b12f

## TYPICAL PERFORMANCE CHARACTERISTICS UV/OV = 4V refers to UV = 4V for the LTC4251B-2.

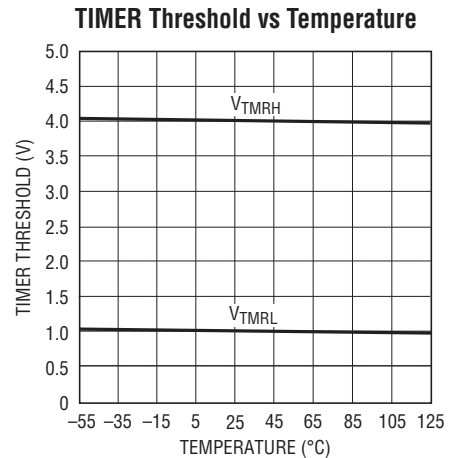
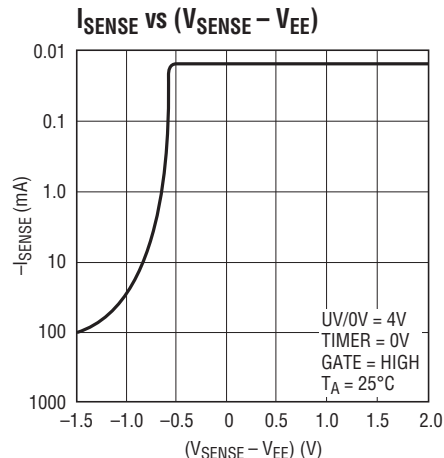
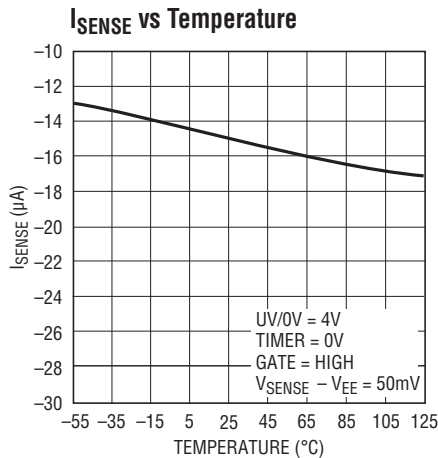
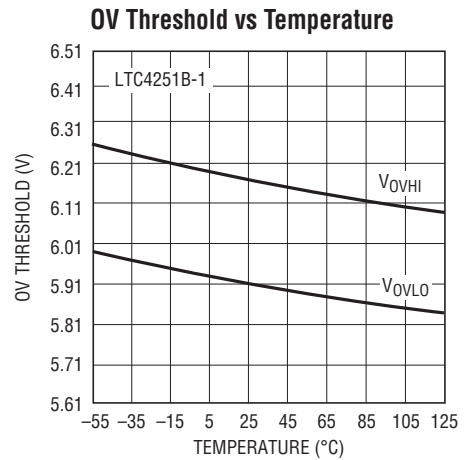
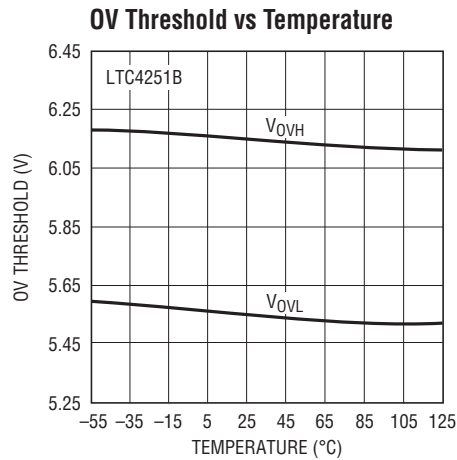
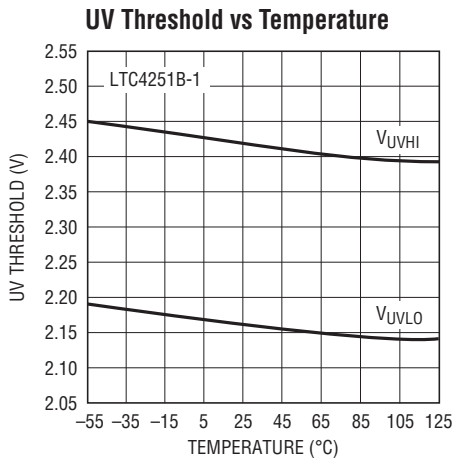
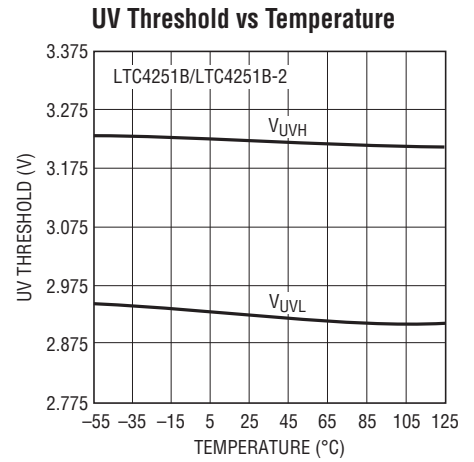
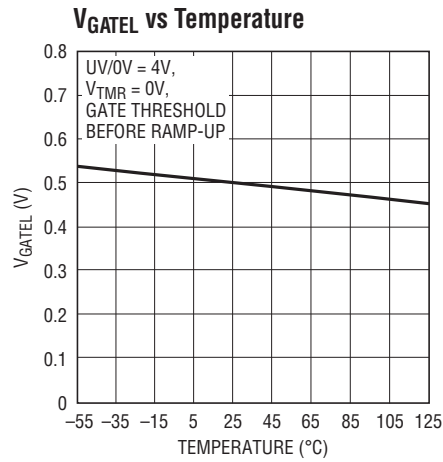
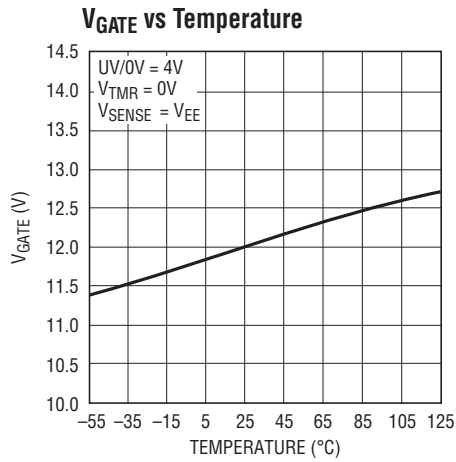

# LTC4251B/LTC4251B-1/ LTC4251B-2

## TYPICAL PERFORMANCE CHARACTERISTICS UV/OV = 4V refers to UV = 4V for the LTC4251B-2.

**$I_{TMR}$  (Initial Cycle, Sourcing) vs Temperature**

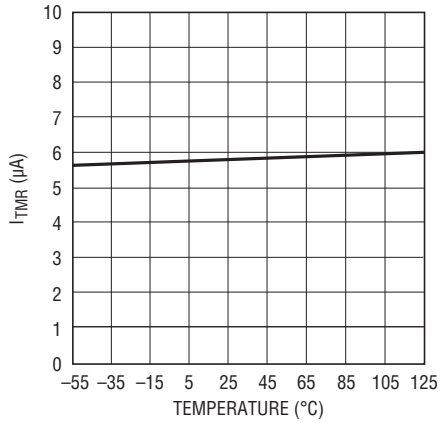

4251b12 G22

**$I_{TMR}$  (Initial Cycle, Sinking) vs Temperature**

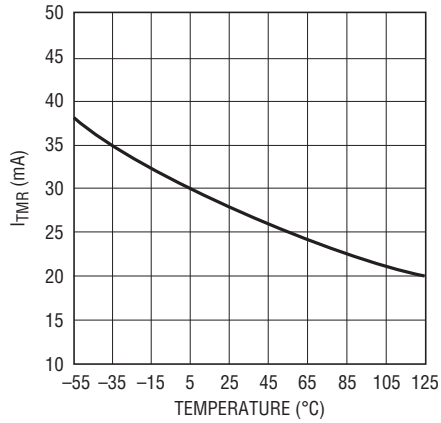

4251b12 G23

**$I_{TMR}$  (Circuit Breaking, Sourcing) vs Temperature**

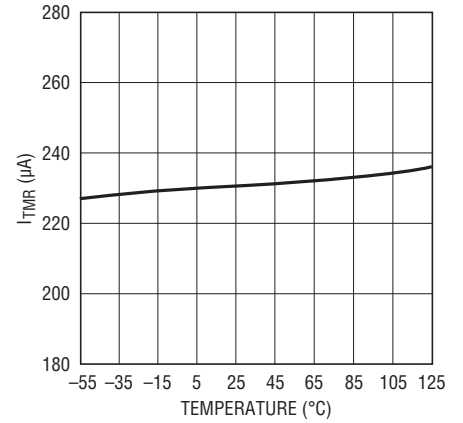

4251b12 G24

**$I_{TMR}$  (Cooling Cycle, Sinking) vs Temperature**

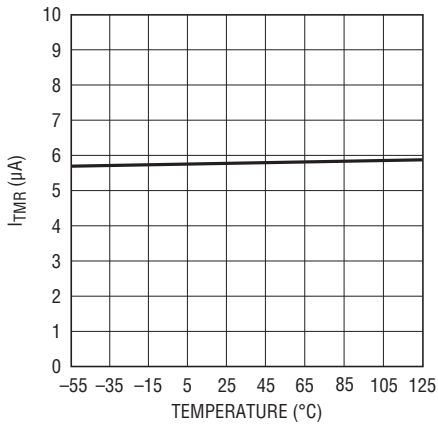

4251b12 G25

**$t_{PLLUG}$  and  $t_{PHLOG}$  vs Temperature**

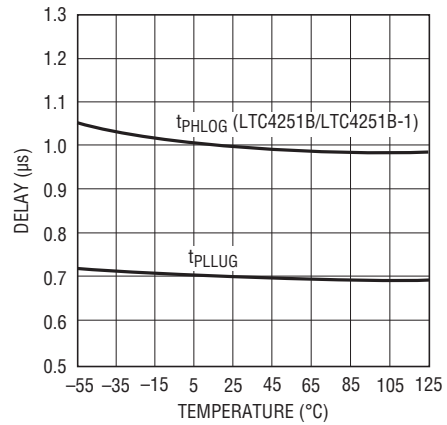

4251b12 G26

**PIN FUNCTIONS** UV/OV refers to the UV pin for the LTC4251B-2. The OV comparator in the LTC4251B-2 is disabled. All references in the text to overvoltage, OV,  $V_{OVHI}$  and  $V_{OVLO}$  do not apply to the LTC4251B-2.

**SENSE (Pin 1):** Circuit Breaker/Current Limit SENSE Pin. Load current is monitored by sense resistor  $R_S$  connected between SENSE and  $V_{EE}$ , and controlled in three steps. If SENSE exceeds  $V_{CB}$  (50mV), the circuit breaker comparator activates a 230 $\mu$ A TIMER pin pull-up current. The LTC4251B/LTC4251B-1/LTC4251B-2 latch off when  $C_T$  charges to 4V. If SENSE exceeds  $V_{ACL}$  (100mV), the analog current limit amplifier pulls GATE down and regulates the MOSFET current at  $V_{ACL}/R_S$ . In the event of a catastrophic short-circuit, SENSE may overshoot 100mV. If SENSE reaches  $V_{FCL}$  (200mV), the fast current limit comparator pulls GATE low with a strong pull-down. To disable the circuit breaker and current limit functions, connect SENSE to  $V_{EE}$ .

Kelvin-sense connections between the sense resistor and the  $V_{EE}$  and SENSE pins are strongly recommended, see Figure 6.

**$V_{EE}$  (Pin 2):** Negative Supply Voltage Input. Connect this pin to the negative side of the power supply.

**$V_{IN}$  (Pin 3):** Positive Supply Input. Connect this pin to the positive side of the supply through a dropping resistor. A shunt regulator typically clamps  $V_{IN}$  at 13V. An internal undervoltage lockout (UVLO) circuit holds GATE low until the  $V_{IN}$  pin is greater than  $V_{LKO}$  (9.2V), overriding UV/OV. If UV is high, OV is low and  $V_{IN}$  comes out of UVLO, TIMER starts an initial timing cycle before initiating a GATE ramp up. If  $V_{IN}$  drops below approximately 8.2V, GATE pulls low immediately.

**TIMER (Pin 4):** Timer Input. TIMER is used to generate a delay at start-up, and to delay shutdown in the event of an output overload. TIMER starts an initial timing cycle when the following conditions are met: UV is high, OV is low,  $V_{IN}$  clears UVLO, TIMER pin is low, GATE is lower than  $V_{GATEL}$  and  $V_{SENSE} - V_{EE} < V_{CB}$ . A pull-up current of 5.8 $\mu$ A then charges  $C_T$ , generating a time delay. If  $C_T$  charges to  $V_{TMRH}$  (4V) the timing cycle terminates, TIMER quickly pulls low and GATE is activated.

If SENSE exceeds 50mV while GATE is high, a 230 $\mu$ A pull-up current charges  $C_T$ . If SENSE drops below 50mV before TIMER reaches 4V, a 5.8 $\mu$ A pull-down current slowly discharges  $C_T$ . In the event that  $C_T$  eventually integrates up to the 4V  $V_{TMRH}$  threshold, TIMER latches high with a 5.8 $\mu$ A pull-up source and GATE quickly pulls low. The LTC4251B/LTC4251B-1/LTC4251B-2 fault latches may be cleared by either pulling TIMER low with an external device, or by pulling UV/OV below  $V_{UVLO}$ .

**UV/OV (Pin 5):** Undervoltage/Overvoltage Input. This dual function pin detects undervoltage as well as overvoltage. The high threshold at the UV comparator is set at  $V_{UVHI}$  with  $V_{UVHST}$  hysteresis. The high threshold at the OV comparator is set at  $V_{OVHI}$  with  $V_{OVHST}$  hysteresis. If  $UV/OV < V_{UVLO}$  or  $UV/OV > V_{OVHI}$ , GATE pulls low. If  $UV/OV > V_{UVHI}$  and  $UV/OV < V_{OVLO}$ , the LTC4251B/LTC4251B-1/LTC4251B-2 attempt to start-up. The internal UVLO at  $V_{IN}$  always overrides UV/OV. A low at UV resets an internal fault latch. A high at OV pulls GATE low but does not reset the fault latch. A 1nF to 10nF capacitor at UV/OV eliminates transients and switching noise from affecting the UV/OV thresholds and prevents glitches at the GATE pin.

**GATE (Pin 6):** N-Channel MOSFET Gate Drive Output. This pin is pulled high by a 58 $\mu$ A current source. GATE is pulled low by invalid conditions at  $V_{IN}$  (UVLO), UV/OV, or the fault latch. GATE is actively servoed to control fault current as measured at SENSE. A compensation capacitor at GATE stabilizes this loop. A comparator monitors GATE to ensure that it is low before allowing an initial timing cycle, GATE ramp up after an overvoltage event, or restart after a current limit fault.

# LTC4251B/LTC4251B-1/ LTC4251B-2

## BLOCK DIAGRAM

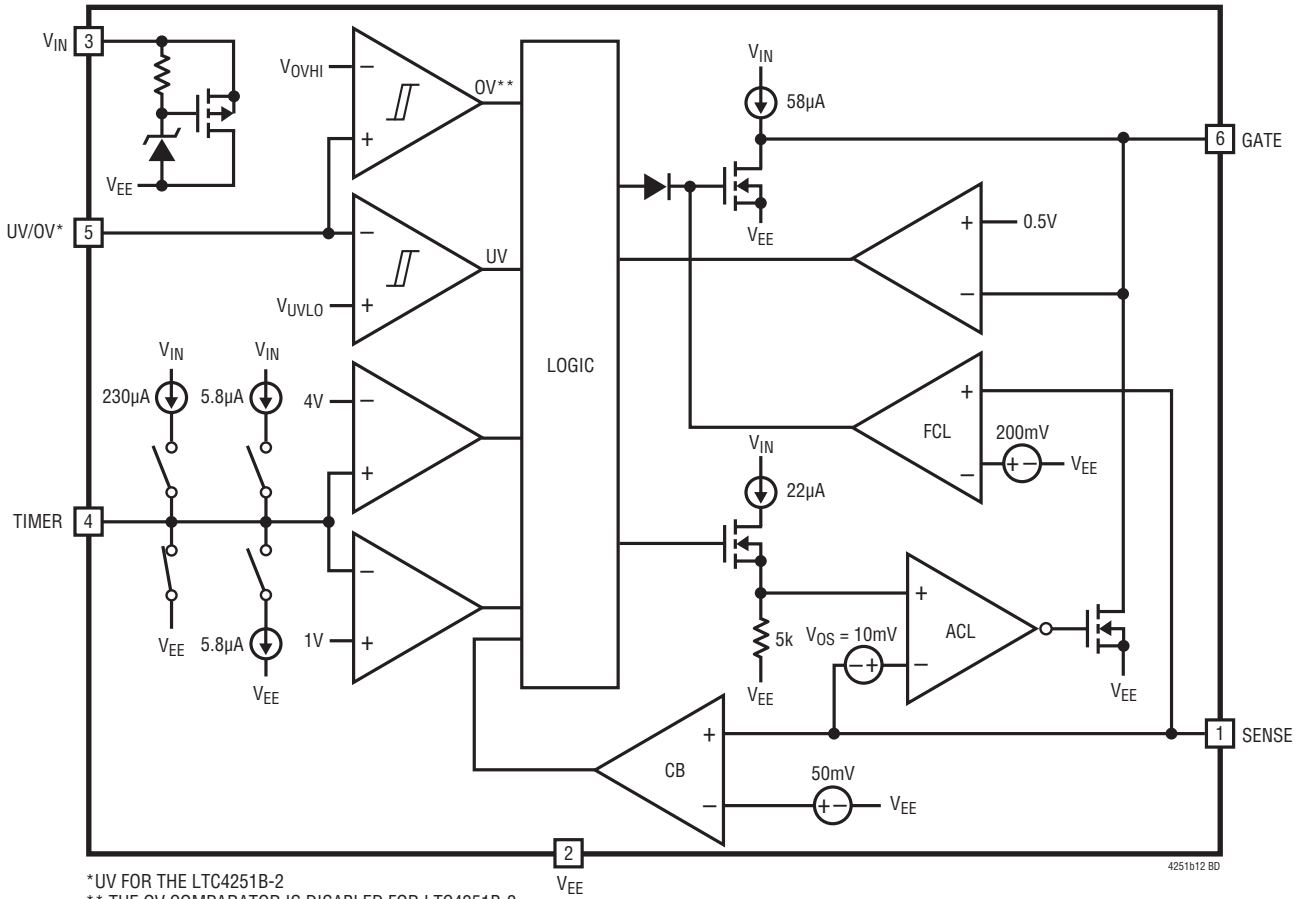



**OPERATION** Note that for simplicity, the following assumptions are made in the text. Firstly, UV/OV also means the UV pin of the LTC4251B-2. Secondly, all overvoltage conditions and references to OV,  $V_{OVHI}$  and  $V_{OVLO}$  do not apply to the LTC4251B-2 as the OV comparator in this part is disabled.

## Hot Circuit Insertion

When circuit boards are inserted into a live backplane, the supply bypass capacitors can draw huge transient currents from the power bus as they charge. The flow of current damages the connector pins and glitches the power bus, causing other boards in the system to reset. The LTC4251B/LTC4251B-1/LTC4251B-2 are designed to turn on a circuit board supply in a controlled manner, allowing insertion or removal without glitches or connector damage.

## Initial Start-Up

The LTC4251B/LTC4251B-1/LTC4251B-2 reside on a removable circuit board and control the path between the connector and load or power conversion circuitry with an external MOSFET switch (see Figure 1). Both inrush control and short-circuit protection are provided by the MOSFET.

A detailed schematic is shown in Figure 2.  $-48V$  and  $-48RTN$  receive power through the longest connector pins, and are the first to connect when the board is inserted. The GATE pin holds the MOSFET off during this time. UV/OV determines whether or not the MOSFET should be turned on based upon internal, high accuracy thresholds and an external divider. UV/OV does double duty by also monitoring whether or not the connector is seated. The top of the divider detects  $-48RTN$  by way of a short connector pin that is the last to mate during the insertion sequence.

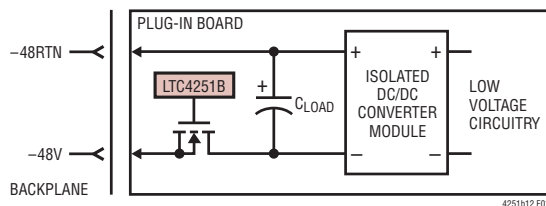

Figure 1. Basic LTC4251B Hot Swap Topology

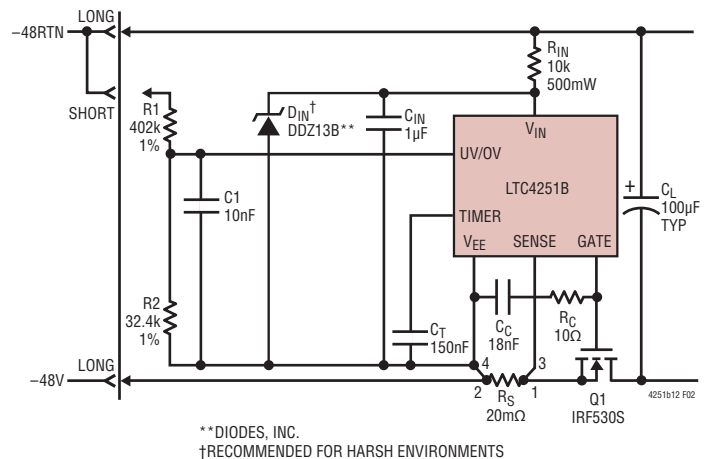

Figure 2.  $-48V$ , 2.5A Hot Swap Controller

## Interlock Conditions

A start-up sequence commences once five initial “interlock” conditions are met:

1. The input voltage  $V_{IN}$  exceeds 9.2V ( $V_{LKO}$ )
2. The voltage at UV/OV falls within the range of  $V_{UVHI}$  to  $V_{OVLO}$  ( $UV > V_{UVHI}$ , LTC4251B-2)
3. The (SENSE –  $V_{EE}$ ) voltage is  $<50mV$  ( $V_{CB}$ )
4. The voltage on the timer capacitor ( $C_T$ ) is less than 1V ( $V_{TMRL}$ )
5. GATE is less than 0.5V ( $V_{GATEL}$ )

The first two conditions are continuously monitored and the latter three are checked prior to initial timing or GATE ramp-up. Upon exiting an OV condition, the TIMER pin voltage requirement is inhibited. Details are described in the Applications Information, Timing Waveforms section.

TIMER begins the start-up sequence by sourcing 5.8 $\mu A$  into  $C_T$ . If  $V_{IN}$  or UV/OV falls out of range, the start-up cycle stops and TIMER discharges  $C_T$  to less than 1V, then waits until the aforementioned conditions are once again met. If  $C_T$  successfully charges to 4V, TIMER pulls low and GATE is released. GATE sources 58 $\mu A$  ( $I_{GATE}$ ), charging the MOSFET gate and associated capacitance.

## OPERATION

Two modes of operation are possible during the time the MOSFET is first turning on, depending on the values of external components, MOSFET characteristics and nominal design current. One possibility is that the MOSFET will turn on gradually so that the inrush into the load capacitance remains a low value. The output will simply ramp to  $-48\text{V}$  and the MOSFET will be fully enhanced. A second possibility is that the load current exceeds the current limit threshold of  $100\text{mV}/R_S$ . In this case, the LTC4251B/LTC4251B-1/LTC4251B-2 will ramp the output by sourcing  $100\text{mV}/R_S$  current into the load capacitance. It is important to set the timer delay so that, regardless of which start-up mode is used, the start-up time is less than the TIMER delay time. If this condition is not met, the LTC4251B/LTC4251B-1/LTC4251B-2 may shutdown after one TIMER delay.

### Board Removal

If the board is withdrawn from the card cage, the UV/OV divider is the first to lose connection. This shuts off the MOSFET and commutates the flow of current in the connector. When the power pins subsequently separate, there is no arcing.

### Current Control

Three levels of protection handle short-circuit and overload conditions. Load current is monitored by SENSE and resistor  $R_S$ . There are three distinct thresholds at SENSE:  $50\text{mV}$  for a timed circuit breaker function;  $100\text{mV}$  for an analog current limit loop; and  $200\text{mV}$  for a fast, feedforward comparator which limits peak current in the event of a catastrophic short-circuit.

If, owing to an output overload, the voltage drop across  $R_S$  exceeds  $50\text{mV}$ , TIMER sources  $230\mu\text{A}$  into  $C_T$ .  $C_T$  eventually charges to a  $4\text{V}$  threshold and the LTC4251B/LTC4251B-1/LTC4251B-2 latches off. If the overload goes away and SENSE measures less than  $50\text{mV}$ ,  $C_T$  slowly discharges ( $5.8\mu\text{A}$ ).

In this way the circuit breaker function will also respond to low duty cycle overloads, and accounts for fast heating and slow cooling characteristic of the MOSFET.

Higher overloads are handled by an analog current limit loop. If the drop across  $R_S$  reaches  $100\text{mV}$ , the current limiting loop servos the MOSFET gate and maintains a constant output current of  $100\text{mV}/R_S$ . Note that because  $\text{SENSE} > 50\text{mV}$ , TIMER charges  $C_T$  during this time and the LTC4251B/LTC4251B-1/LTC4251B-2 will eventually shut down.

Low impedance failures on the load side of the LTC4251B/LTC4251B-1/LTC4251B-2 coupled with  $48\text{V}$  or more driving potential can produce current slew rates well in excess of  $50\text{A}/\mu\text{s}$ . Under these conditions, overshoot is inevitable. A fast SENSE comparator with a threshold of  $200\text{mV}$  detects overshoot and pulls GATE low much harder and hence much faster than can the weaker current limit loop. The  $100\text{mV}/R_S$  current limit loop then takes over, and servos the current as previously described. As before, TIMER runs and latches the LTC4251B/LTC4251B-1/LTC4251B-2 off when  $C_T$  reaches  $4\text{V}$ .

The LTC4251B/LTC4251B-1/LTC4251B-2 circuit breaker latch is reset by either pulling UV/OV momentarily low, or dropping the input voltage  $V_{IN}$  below the internal UVLO threshold of  $8.2\text{V}$ .

Although short-circuits are the most obvious fault type, several operating conditions may invoke overcurrent protection. Noise spikes from the backplane or load, input steps caused by the connection of a second, higher voltage supply, transient currents caused by faults on adjacent circuit boards sharing the same power bus, or the insertion of non-hot swappable products could cause higher than anticipated input current and temporary detection of an overcurrent condition. The action of TIMER and  $C_T$  rejects these events allowing the LTC4251B/LTC4251B-1/LTC4251B-2 to “ride out” temporary overloads and disturbances that would trip a simple current comparator and in some cases, blow a fuse.

## APPLICATIONS INFORMATION

### SHUNT REGULATOR

A fast responding shunt regulator clamps the  $V_{IN}$  pin to 13V ( $V_Z$ ). Power is derived from  $-48RTN$  by an external current limiting resistor,  $R_{IN}$ . A  $1\mu F$  decoupling capacitor,  $C_{IN}$  filters supply transients and contributes a short delay at start-up.

To meet creepage requirements  $R_{IN}$  may be split into two or more series connected units, such as two 5.1k or three 3.3k resistors. This introduces a wider total spacing than is possible with a single component while at the same time ballasting the potential across the gap under each resistor. The LTC4251B is fundamentally a low voltage device that operates with  $-48V$  as its reference ground. To further protect against arc discharge into its pins, the area in and around the LTC4251B and all associated components should be free of any other planes such as chassis ground, return, or secondary-side power and ground planes.

$V_{IN}$  is rated handle 30mA within the thermal limits of the package, and is tested to survive a  $100\mu s$ , 100mA pulse. To protect  $V_{IN}$  against damage from higher amplitude spikes, clamp  $V_{IN}$  to  $V_{EE}$  with a 13V Zener diode. Star connect  $V_{EE}$  and all  $V_{EE}$  referred components to the sense resistor Kelvin terminal as illustrated in Figure 2, keeping trace lengths between  $V_{IN}$ ,  $C_{IN}$ ,  $D_{IN}$  and  $V_{EE}$  as short as possible.

### INTERNAL UNDERVOLTAGE LOCKOUT (UVLO)

Internal circuitry monitors  $V_{IN}$  for undervoltage. The exact thresholds are defined by  $V_{LKO}$  and its hysteresis,  $V_{LKH}$ . When  $V_{IN}$  rises above 9.2V ( $V_{LKO}$ ) the chip is enabled; below 8.2V ( $V_{LKO}-V_{LKH}$ ) it is disabled and GATE is pulled low. The UVLO function at  $V_{IN}$  should not be confused with the UV/OV pin. These are completely separate functions.

### UV/OV COMPARATORS

Two hysteretic comparators for detecting under- and overvoltage conditions, with the following thresholds, monitor the dual function UV/OV pin:

UV turning on at  $V_{UVHI}$

UV turning off at  $V_{UVLO}$

OV turning off at  $V_{OVHI}$

OV turning on at  $V_{OVLO}$

The UV and OV trip point ratio for LTC4251B is designed to match the standard telecom operating range of 43V to 75V. The LTC4251B-2 implements a UV threshold of 43V only.

A divider ( $R_1$ ,  $R_2$ ) is used to scale the supply voltage. Using  $R_1 = 402k$  and  $R_2 = 32.4k$  gives a typical operating range of 43.2V to 74.4V. The under- and overvoltage shutdown thresholds are then 39.2V and 82.5V. 1% divider resistors are recommended to preserve threshold accuracy. The same resistor values can be used for the LTC4251B-2.

The  $R_1$ - $R_2$  divider values shown in the Typical Application set a standing current of slightly more than  $100\mu A$ , and define an impedance at UV/OV of 30k. In most applications, 30k impedance coupled with 300mV UV hysteresis makes the LTC4251B/LTC4251B-1/LTC4251B-2 insensitive to noise. If more noise immunity is desired, add a 1nF to 10nF filter capacitor from UV/OV to  $V_{EE}$ .

The UV and OV trip point thresholds for the LTC4251B-1 are designed to encompass the standard telecom operating range of  $-36V$  to  $-72V$ .

A divider ( $R_1$ ,  $R_2$ ) is used to scale the supply voltage. Using  $R_1 = 442k$  and  $R_2 = 34.8k$  gives a typical operating range of 33.2V to 81V. The typical under- and overvoltage shutdown thresholds are then 29.6V and 84.5V. 1% divider resistors are recommended to preserve threshold accuracy.

The  $R_1$ - $R_2$  divider values shown in the Typical Application set a standing current of slightly more than  $100\mu A$ , and define an impedance at UV/OV of 32k. In most applications, 32k impedance coupled with 260mV UV hysteresis makes the LTC4251B-1 insensitive to noise. If more noise immunity is desired, add a 1nF to 10nF filter capacitor from UV/OV to  $V_{EE}$ .

### UV/OV OPERATION

A low input to the UV comparator will reset the chip and pull the GATE and TIMER pins low. A low-to-high UV transition will initiate an initial timing sequence if the three remaining interlock conditions are met.

## APPLICATIONS INFORMATION

Overvoltage conditions detected by the OV comparator will also pull GATE low, thereby shutting down the load, but it will not reset the circuit breaker latch. Returning the supply voltage to an acceptable range restarts the GATE pin provided all interlock conditions except TIMER are met.

### TIMER

The operation of the TIMER pin is somewhat complex as it handles several key functions. A capacitor,  $C_T$ , is used at TIMER to provide timing for the LTC4251B/LTC4251B-1/LTC4251B-2. Four different charging and discharging modes are available at TIMER:

1.  $5.8\mu\text{A}$  slow charge; initial timing delay
2.  $230\mu\text{A}$  fast charge; circuit breaker delay
3.  $5.8\mu\text{A}$  slow discharge; circuit breaker “cool-off”
4. Low impedance switch; resets capacitor after initial timing delay, in undervoltage lockout, and in overvoltage

For initial startup, the  $5.8\mu\text{A}$  pull-up is used. The low impedance switch is turned off and the  $5.8\mu\text{A}$  current source is enabled when the four interlock conditions are met.  $C_T$  charges to 4V in a time period given by:

$$t = \frac{4V \cdot C_T}{5.8\mu\text{A}} \quad (1)$$

When  $C_T$  reaches 4V ( $V_{\text{TMRH}}$ ), the low impedance switch turns on and discharges  $C_T$ . The GATE output is enabled and the load turns on.

### CIRCUIT BREAKER TIMER OPERATION

If the SENSE pin detects more than 50mV across  $R_S$ , the TIMER pin charges  $C_T$  with  $230\mu\text{A}$ . If  $C_T$  charges to 4V, the GATE pin pulls low and the LTC4251B/LTC4251B-1/LTC4251B-2 latch off. The part remains latched off until either the UV/OV pin is momentarily pulsed low, or  $V_{\text{IN}}$  dips into UVLO and is then restored. The circuit breaker timeout period is given by

$$t = \frac{4V \cdot C_T}{230\mu\text{A}} \quad (2)$$

Intermittent overloads may exceed the 50mV threshold at SENSE, but if their duration is sufficiently short TIMER will not reach 4V and the LTC4251B/LTC4251B-1/LTC4251B-2 will not latch off. To handle this situation, the TIMER discharges  $C_T$  slowly with a  $5.8\mu\text{A}$  pull-down whenever the SENSE voltage is less than 50mV. Therefore any intermittent overload with an aggregate duty cycle of 2.5% or more will eventually trip the circuit breaker and latch off the LTC4251B/LTC4251B-1/LTC4251B-2. Figure 3 shows the circuit breaker response time in seconds normalized to  $1\mu\text{F}$ . The asymmetric charging and discharging of  $C_T$  is a fair gauge of MOSFET heating.

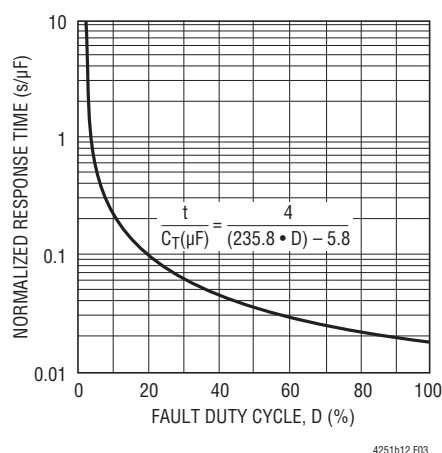

Figure 3. Circuit Breaker Response Time

### GATE

GATE is pulled low to  $V_{\text{EE}}$  under any of the following conditions: in UVLO, during the initial timing cycle, in an overvoltage condition, or when the LTC4251B/LTC4251B-1/LTC4251B-2 are latched off after a short-circuit. When GATE turns on, a  $58\mu\text{A}$  current source charges the MOSFET gate and any associated external capacitance.  $V_{\text{IN}}$  limits gate drive to no more than 14.5V.

Gate-drain capacitance ( $C_{\text{GD}}$ ) feed through at the first abrupt application of power can cause a gate-source voltage sufficient to turn on the MOSFET. A unique circuit pulls GATE low with practically no usable voltage at  $V_{\text{IN}}$ , and eliminates current spikes at insertion. A large external gate-source capacitor is thus unnecessary for the purpose of compensating  $C_{\text{GD}}$ . Instead, a smaller value ( $\geq 10\text{nF}$ ) capacitor  $C_C$  is adequate.  $C_C$  also provides compensation for the analog current limit loop.

## APPLICATIONS INFORMATION

### SENSE

The SENSE pin is monitored by the circuit breaker (CB) comparator, the analog current limit (ACL) amplifier, and the fast current limit (FCL) comparator. Each of these three measures the potential of SENSE relative to  $V_{EE}$ . If SENSE exceeds 50mV, the CB comparator activates the 230 $\mu$ A TIMER pull-up. At 100mV, the ACL amplifier servos the MOSFET current, and at 200mV the FCL comparator abruptly pulls GATE low in an attempt to bring the MOSFET current under control. If any of these conditions persists long enough for TIMER to charge  $C_T$  to 4V (see Equation (2)), the LTC4251B/LTC4251B-1/LTC4251B-2 latch off and pull GATE low.

If the SENSE pin encounters a voltage greater than 100mV, the ACL amplifier will servo GATE downwards in an attempt to control the MOSFET current. Since GATE overdrives the MOSFET in normal operation, the ACL amplifier needs time to discharge GATE to the threshold of the MOSFET. For a mild overload, the ACL amplifier can control the MOSFET current, but in the event of a severe overload the current may overshoot. At SENSE = 200mV, the FCL comparator takes over, quickly discharging the GATE pin to near  $V_{EE}$  potential. FCL then releases, and the ACL amplifier takes over. All the while TIMER is running. The effect of FCL is to add a nonlinear response to the control loop in favor of reducing MOSFET current.

Owing to inductive effects in the system, FCL typically overcorrects the current limit loop, and GATE undershoots. A zero in the loop (resistor  $R_C$  in series with the gate capacitor) helps the ACL amplifier recover.

### SHORT-CIRCUIT OPERATION

Circuit behavior arising from a load-side low impedance short is shown in Figure 4. Initially, the current overshoots the analog current limit level of  $V_{SENSE} = 100\text{mV}$  (Trace 2) as the GATE pin works to bring  $V_{GS}$  under control (Trace 3). The overshoot glitches the backplane in the negative direction, and when the current is reduced to  $100\text{mV}/R_S$  the backplane responds by glitching in the positive direction.

TIMER commences charging  $C_T$  (Trace 4) while the analog current limit loop maintains the fault current at  $100\text{mV}/R_S$ , which in this case is 5A (Trace 2). Note that the backplane voltage (Trace 1) sags under load. When  $C_T$  reaches 4V, GATE turns off, the load current drops to zero and the backplane rings up to over 100V. The positive peak is usually limited by avalanche breakdown in the MOSFET, and can be further limited by adding a transient voltage suppressor across the input from  $-48\text{V}$  to  $-48\text{RTN}$ , such as Diodes Inc. SMAT70A.

A low impedance short on one card may influence the behavior of others sharing the same backplane. The initial glitch and backplane sag as seen in Figure 4, Trace 1, can rob charge from output capacitors on adjacent cards. When the faulty card shuts down, current flows in to refresh the capacitors. If LTC4251B, LTC4251B-1 or LTC4251B-2s are used throughout, they respond by limiting the inrush current to a value of  $100\text{mV}/R_S$ . If  $C_T$  is sized correctly, the capacitors will recharge long before  $C_T$  times out.

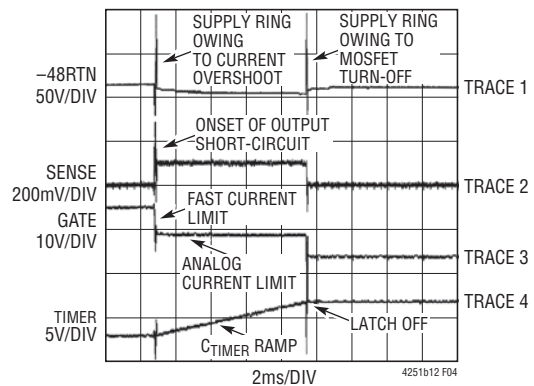

Figure 4. Output Short-Circuit Behavior  
(All Waveforms are Referenced to  $V_{EE}$ )

### MOSFET SELECTION

The external MOSFET switch must have adequate safe operating area (SOA) to charge the load capacitance on start-up and handle short-circuit conditions until TIMER latchoff. These considerations take precedence over DC current ratings. A MOSFET with adequate SOA for a given application can always handle the required current, but the opposite cannot be said. Consult the manufacturer's MOSFET data sheet for safe operating area and effective transient thermal impedance curves.

## APPLICATIONS INFORMATION

MOSFET selection is a three-step process. First,  $R_S$  is calculated, and then the time required to charge the load capacitance is determined. This timing, along with the maximum short-circuit current and maximum input voltage defines an operating point that is checked against the MOSFET's SOA curve.

To begin a design, first specify the required load current and load capacitance,  $I_L$  and  $C_L$ . The circuit breaker current trip point ( $50\text{mV}/R_S$ ) should be set to accommodate the maximum load current. Note that maximum input current to a DC/DC converter is expected at  $V_{\text{SUPPLY (MIN)}}$ .  $R_S$  is given by:

$$R_S = \frac{40\text{mV}}{I_{L(\text{MAX})}} \quad (3)$$

where 40mV represents the guaranteed minimum circuit breaker threshold.

During the initial charging process, the LTC4251B/LTC4251B-1/LTC4251B-2 may operate the MOSFET in current limit, forcing 80mV to 120mV across  $R_S$ . The minimum inrush current is given by:

$$I_{\text{INRUSH(MIN)}} = \frac{80\text{mV}}{R_S} \quad (4)$$

Maximum short-circuit current limit is calculated using maximum  $V_{\text{SENSE}}$ , or:

$$I_{\text{SHORT-CIRCUIT(MAX)}} = \frac{120\text{mV}}{R_S} \quad (5)$$

The TIMER capacitor  $C_T$  must be selected based on the slowest expected charging rate; otherwise TIMER might time out before the load capacitor is fully charged. A value for  $C_T$  is calculated based on the maximum time it takes the load capacitor to charge. That time is given by:

$$t_{\text{CL CHARGE}} = \frac{C \cdot V}{I} = \frac{C_L \cdot V_{\text{SUPPLY(MAX)}}}{I_{\text{INRUSH(MIN)}}} \quad (6)$$

Substituting Equation (4) for  $I_{\text{INRUSH(MIN)}}$  and equating (6) with (2) gives:

$$C_T = \frac{C_L \cdot V_{\text{SUPPLY (MAX)}} \cdot R_S \cdot 230\mu\text{A}}{(4\text{V} \cdot 80\text{mV})} \quad (7)$$

Returning to Equation (2), the TIMER period is calculated and used in conjunction with  $V_{\text{SUPPLY(MAX)}}$  and  $I_{\text{SHORT-CIRCUIT(MAX)}}$  to check the SOA curves of a prospective MOSFET.

As a numerical design example, consider a 30W load, which requires 1A input current at 36V. If  $V_{\text{SUPPLY(MAX)}} = 72\text{V}$  and  $C_L = 100\mu\text{F}$ , Equation (3) gives  $R_{\text{SENSE}} = 40\text{m}\Omega$ ; Equation (7) gives  $C_T = 207\text{nF}$ . To account for errors in  $R_{\text{SENSE}}$ ,  $C_T$ , TIMER current ( $230\mu\text{A}$ ) and TIMER threshold (4V), the calculated value should be multiplied by 1.5, giving a nearest standard value of  $C_T = 330\text{nF}$ .

If a short-circuit occurs, a current of up to  $120\text{mV}/40\text{m}\Omega = 3\text{A}$  will flow in the MOSFET for 5.7ms as dictated by  $C_T = 330\text{nF}$  in Equation (2). The MOSFET must be selected based on this criterion. The IRF530S can handle 100V and 3A for 10ms, and is safe to use in this application.

## SUMMARY OF DESIGN FLOW

To summarize the design flow, consider the application shown in Figure 2, which was designed for 50W:

Calculate maximum load current:  $50\text{W}/36\text{V} = 1.4\text{A}$ ; allowing 83% converter efficiency,  $I_{\text{IN (MAX)}} = 1.7\text{A}$ .

Calculate  $R_S$ : from Equation (3)  $R_S = 20\text{m}\Omega$ .

Calculate  $C_T$ : from Equation (7)  $C_T = 150\text{nF}$  (including 1.5X correction factor).

Calculate TIMER period: from Equation (2) the short-circuit time-out period is  $t = 2.6\text{ms}$ .

Calculate maximum short-circuit current: from Equation (5) maximum short-circuit current could be as high as  $120\text{mV}/20\text{m}\Omega = 6\text{A}$ .

Consult MOSFET SOA curves: the IRF530S can handle 6A at 72V for 5ms, so it is safe to use in this application.

## APPLICATIONS INFORMATION

### FREQUENCY COMPENSATION

The LTC4251B/LTC4251B-1/LTC4251B-2 typical frequency compensation network for the analog current limit loop is a series  $R_C$  ( $10\Omega$ ) and  $C_C$  connected to  $V_{EE}$ . Figure 5 depicts the relationship between the compensation capacitor  $C_C$  and the MOSFET's  $C_{ISS}$ . The line in Figure 5 is used to select a starting value for  $C_C$  based upon the MOSFET's  $C_{ISS}$  specification. Optimized values for  $C_C$  are shown for several popular MOSFETs. Differences in the optimized value of  $C_C$  versus the starting value are small. Nevertheless, compensation values should be verified by board level short-circuit testing.

As seen in Figure 4 previously, at the onset of a short-circuit event, the input supply voltage can ring dramatically owing to series inductance. If this voltage avalanches the MOSFET, current continues to flow through the MOSFET to the output. The analog current limit loop cannot control this current flow and therefore the loop undershoots. This effect cannot be eliminated by frequency compensation. A zener diode is required to clamp the input supply voltage and prevent MOSFET avalanche.

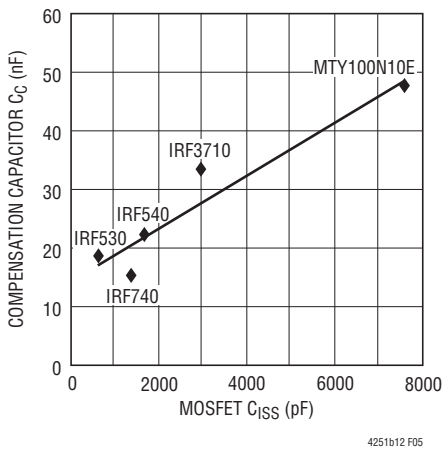

Figure 5. Recommended Compensation Capacitor  $C_C$  vs MOSFET  $C_{ISS}$

### SENSE RESISTOR CONSIDERATIONS

For proper circuit breaker operation, Kelvin-sense PCB connections between the sense resistor and the  $V_{EE}$  and SENSE pins are strongly recommended. The drawing in Figure 6 illustrates the correct way of making connections between the LTC4251B/LTC4251B-1/LTC4251B-2 and the

sense resistor. PCB layout should be balanced and symmetrical to minimize wiring errors. In addition, the PCB layout for the sense resistor should include good thermal management techniques for optimal sense resistor power dissipation.

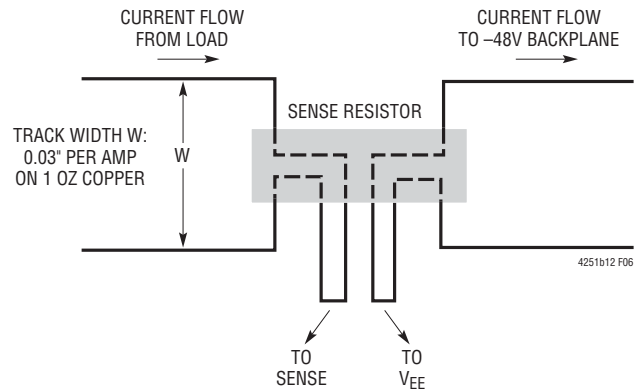

Figure 6. Making PCB Connections to the Sense Resistor

### TIMING WAVEFORMS

#### System Power-Up

Figure 7 details the timing waveforms for a typical power-up sequence in the case where a board is already installed in the backplane and system power is applied abruptly. At time point 1, the supply ramps up, together with UV/OV and  $V_{OUT}$ .  $V_{IN}$  follows at a slower rate as set by the  $V_{IN}$  bypass capacitor. At time point 2,  $V_{IN}$  exceeds  $V_{LKO}$  and the internal logic checks for  $V_{UVHI} < UV/OV < V_{OVLO}$ ,  $TIMER < V_{TMRL}$ ,  $GATE < V_{GATEL}$  and  $SENSE < V_{CB}$ . When all conditions are met, an initial timing cycle starts and the TIMER capacitor is charged by a  $5.8\mu A$  current source pull-up. At time point 3, TIMER reaches the  $V_{TMRH}$  threshold and the initial timing cycle terminates. The TIMER capacitor is then quickly discharged. At time point 4, the  $V_{TMRL}$  threshold is reached and the conditions of  $GATE < V_{GATEL}$  and  $SENSE < V_{CB}$  must be satisfied before a start-up cycle is allowed to begin. GATE sources  $58\mu A$  into the external MOSFET gate and compensation network. When the GATE voltage reaches the MOSFET's threshold, current begins flowing into the load capacitor. At time point 5, the SENSE voltage ( $V_{SENSE} - V_{EE}$ ) reaches the  $V_{CB}$  threshold and activates the TIMER. The TIMER capacitor

## APPLICATIONS INFORMATION

is charged by a 230 $\mu$ A current-source pull-up. At time point 6, the analog current limit loop activates. Between time point 6 and time point 7, the GATE voltage is held essentially constant and the sense voltage is regulated at  $V_{ACL}$ . As the load capacitor nears full charge, its current begins to decline. At point 7, the load current falls and the sense voltage drops below  $V_{ACL}$ . The analog current limit loop shuts off and the GATE pin ramps further. At time point 8, the sense voltage drops below  $V_{CB}$  and TIMER now discharges through a 5.8 $\mu$ A current source pull-down. At time point 9, GATE reaches its maximum voltage as determined by  $V_{IN}$ .

### Live Insertion with Short Pin Control of UV/OV

In this example as shown in Figure 8, power is delivered through long connector pins whereas the UV/OV divider makes contact through a short pin. This ensures the power connections are firmly established before the LTC4251B/LTC4251B-1/LTC4251B-2 are activated. At time point 1, the power pins make contact and  $V_{IN}$  ramps through  $V_{LKO}$ . At time point 2, the UV/OV divider makes contact and its voltage exceeds  $V_{UVHI}$ . In addition, the internal logic checks for  $V_{UVHI} < UV/OV < V_{OVHI}$ ,  $TIMER < V_{TMRL}$ ,  $GATE < V_{GATEL}$  and  $SENSE < V_{CB}$ . When all conditions are met, an initial timing cycle starts and the TIMER capacitor is charged by a 5.8 $\mu$ A current source pull-up. At time point 3, TIMER reaches the  $V_{TMRH}$  threshold and the initial timing cycle terminates. The TIMER capacitor is then quickly discharged. At time point 4, the  $V_{TMRL}$  threshold is reached and the conditions of  $GATE < V_{GATEL}$  and  $SENSE < V_{CB}$  must be satisfied before a start-up cycle is allowed to begin. GATE sources 58 $\mu$ A into the external MOSFET gate and compensation network. When the GATE voltage reaches the MOSFET's threshold, current begins flowing into the load capacitor. At time point 5, the SENSE voltage ( $V_{SENSE} - V_{EE}$ ) reaches the  $V_{CB}$  threshold and activates the TIMER. The TIMER capacitor is charged by a 230 $\mu$ A current source pull-up. At time point 6, the analog current limit loop activates. Between time point 6 and time point 7, the GATE voltage is held essentially constant and the sense voltage is regulated at  $V_{ACL}$ . As the load capacitor nears full charge, its current begins to

decline. At time point 7, the load current falls and the sense voltage drops below  $V_{ACL}$ . The analog current limit loop shuts off and the GATE pin ramps further. At time point 8, the sense voltage drops below  $V_{CB}$  and TIMER now discharges through a 5.8 $\mu$ A current source pull-down. At time point 9, GATE reaches its maximum voltage as determined by  $V_{IN}$ .

### Undervoltage Lockout Timing

In Figure 9, when UV/OV drops below  $V_{UVLO}$  (time point 1), TIMER and GATE pull low. If current has been flowing, the SENSE pin voltage decreases to zero as GATE collapses. When UV/OV recovers and clears  $V_{UVHI}$  (time point 2), an initial time cycle begins followed by a start-up cycle.

### Undervoltage Timing with Overvoltage Glitch

In Figure 10, when UV/OV clears  $V_{UVHI}$  (time point 1), an initial timing cycle starts. If the system bus voltage overshoots  $V_{OVHI}$  as shown at time point 2, TIMER discharges. At time point 3, the supply voltage recovers and drops below the  $V_{OVLO}$  threshold. The initial timing cycle restarts followed by a start-up cycle.

### Overvoltage Timing

During normal operation, if UV/OV exceeds  $V_{OVHI}$  as shown at time point 1 of Figure 11, the TIMER status is unaffected. Nevertheless, GATE pulls down and disconnects the load. At time point 2, UV/OV recovers and drops below the  $V_{OVLO}$  threshold. A gate ramp up cycle ensues. If the overvoltage glitch is long enough to deplete the load capacitor, a full start-up cycle may occur as shown between time points 3 through 6.

### Timer Behavior

In Figure 12a, the TIMER capacitor charges at 230 $\mu$ A if the SENSE pin exceeds  $V_{CB}$ . It is discharged with 5.8 $\mu$ A if the SENSE pin is less than  $V_{CB}$ . In Figure 12b, when TIMER exceeds  $V_{TMRH}$ , TIMER is latched high by the 5.8 $\mu$ A pull-up and GATE pulls down immediately. In Figure 12c, multiple momentary faults cause the TIMER capacitor to integrate until it latches.



## APPLICATIONS INFORMATION

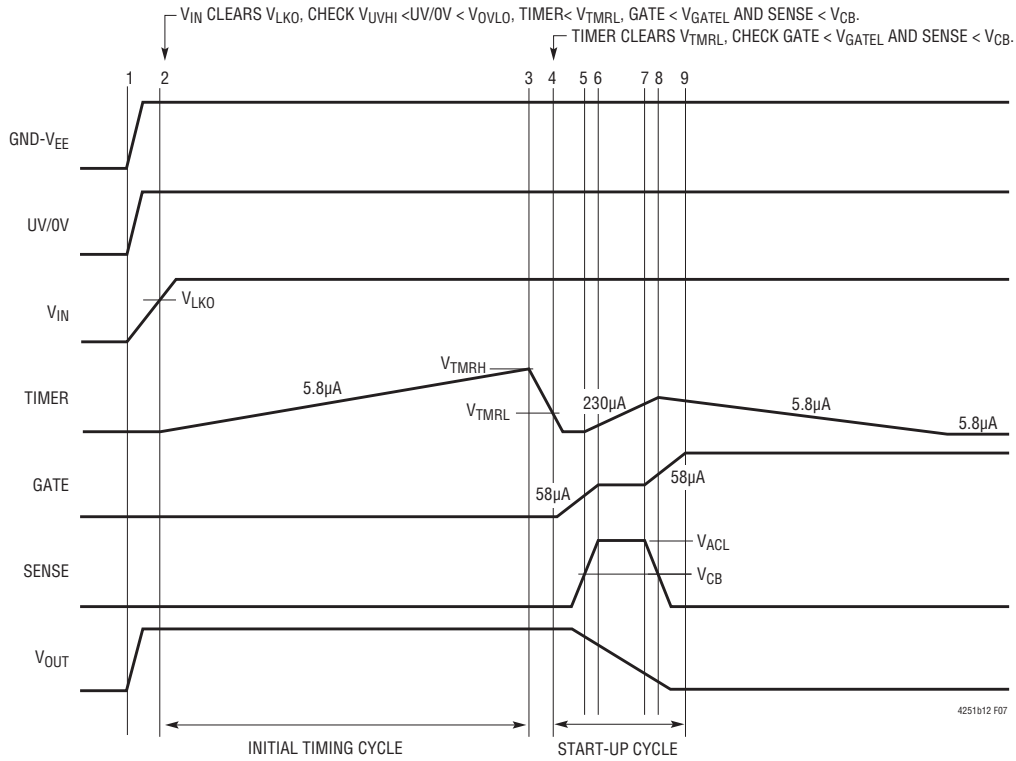

Figure 7. System Power-Up Timing (All Waveforms are Referenced to  $V_{EE}$ )

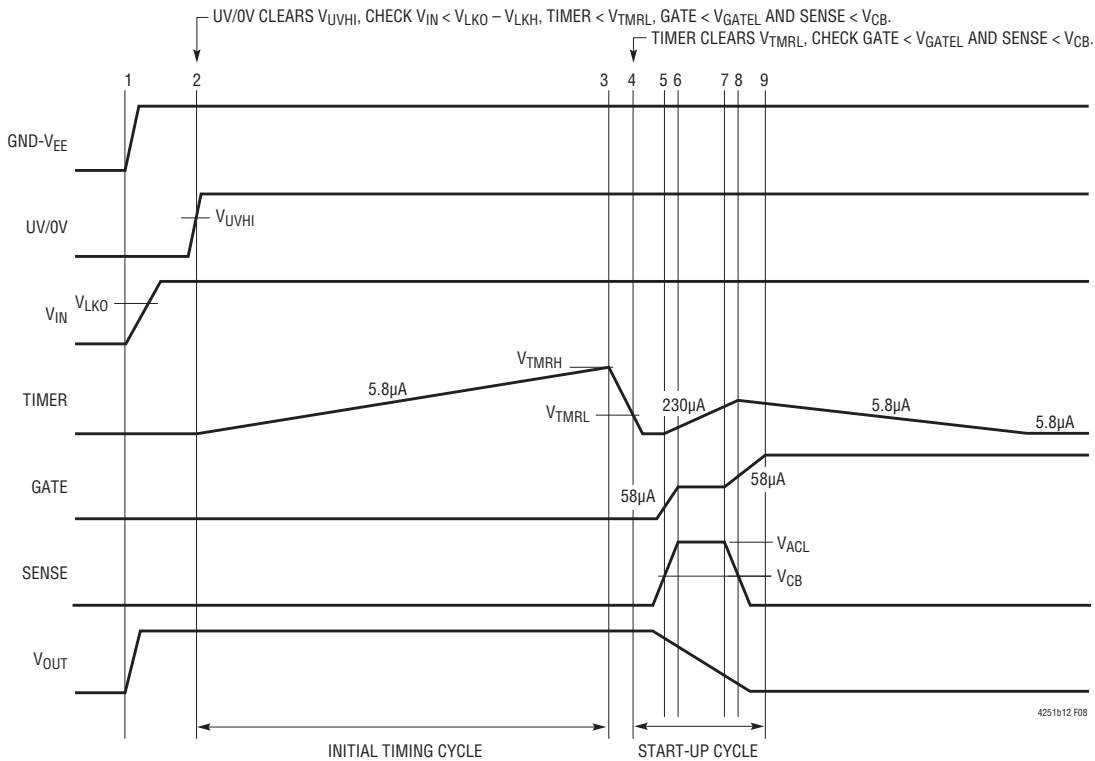

Figure 8. Power-Up Timing with a Short-Pin (All Waveforms are Referenced to  $V_{EE}$ )

## APPLICATIONS INFORMATION

### Analog Current Limit and Fast Current Limit

In Figure 13a, when SENSE exceeds  $V_{ACL}$ , GATE is regulated by the analog current limit amplifier loop. When SENSE drops below  $V_{ACL}$ , GATE is allowed to pull up. In Figure 13b, when a severe fault occurs, SENSE exceeds  $V_{FCL}$  and GATE immediately pulls down until the analog current limit amplifier can establish control. If TIMER reaches  $V_{TMRH}$ , GATE pulls low and latches off.

### Resetting a Fault Latch

As shown in Figure 14, a latched fault is reset by either pulling UV/OV below  $V_{UVLO}$  or pulling TIMER below  $V_{TMRL}$ .

An initial timing cycle is initiated if UV/OV is used for reset. If TIMER is used for reset, the initial timing cycle is skipped.

### Internal Soft-Start

An internal soft-start feature ramps the positive input of the analog current limit amplifier during initial start-up. The ramp duration is approximately 200 $\mu$ s. This feature reduces load current  $dI/dt$  at start-up. As illustrated in Figure 15, soft-start is initiated by a TIMER transition from  $V_{TMRH}$  to  $V_{TMRL}$  or when UV/OV falls below the  $V_{OVLO}$  threshold after an OV fault. After soft-start duration, load current is limited by  $V_{ACL}/R_S$ .

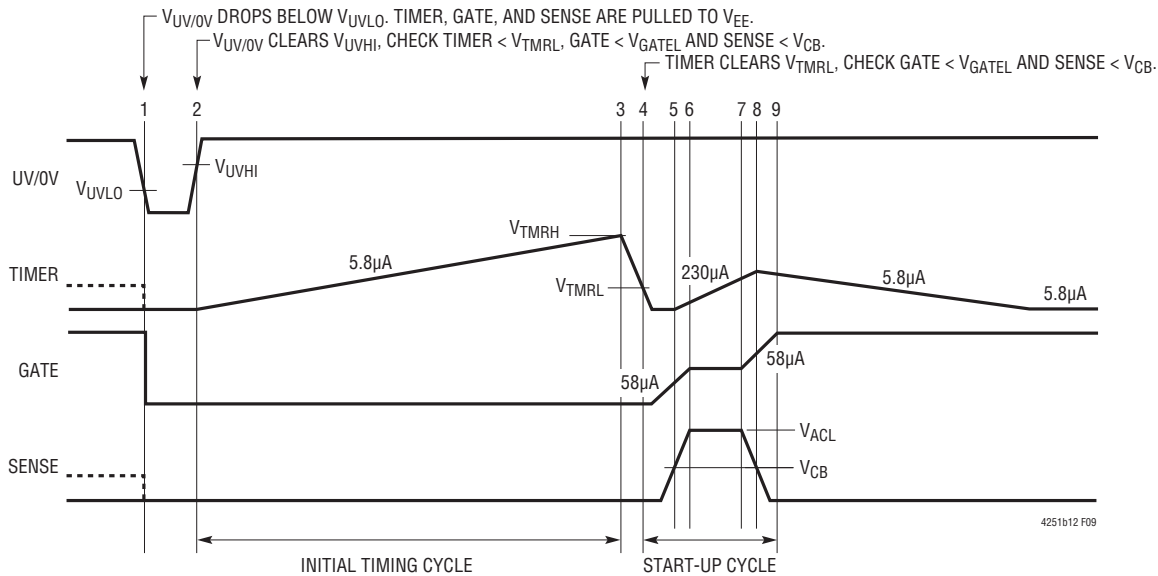

Figure 9. Undervoltage Lockout Timing (All Waveforms are Referenced to  $V_{EE}$ )

## APPLICATIONS INFORMATION

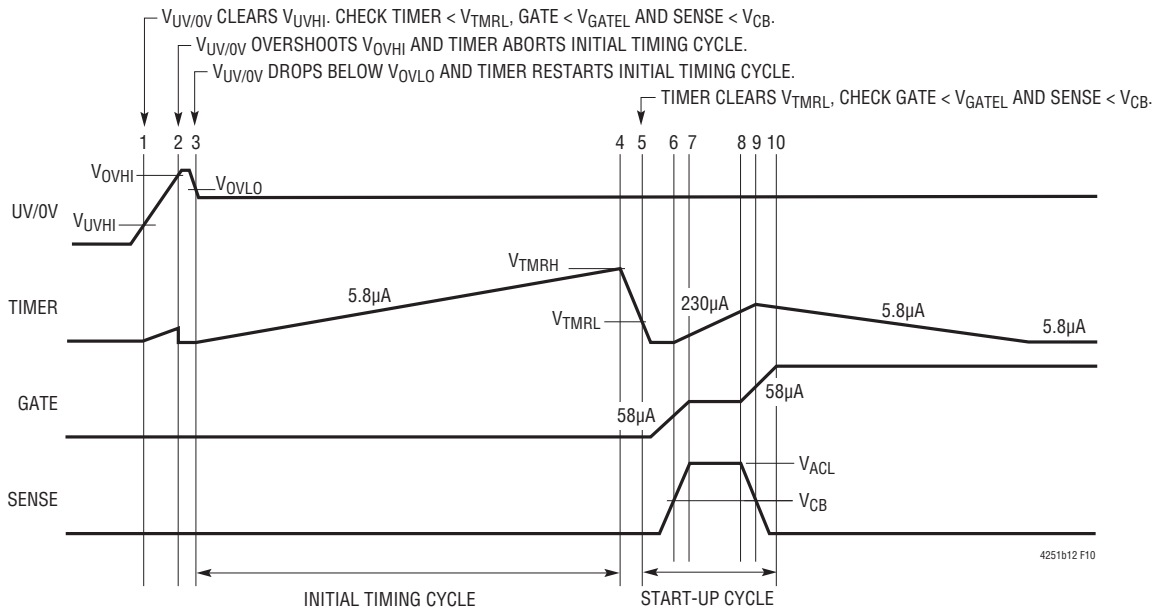

Figure 10. Undervoltage Timing with an Overvoltage Glitch (All Waveforms are Referenced to  $V_{EE}$ )

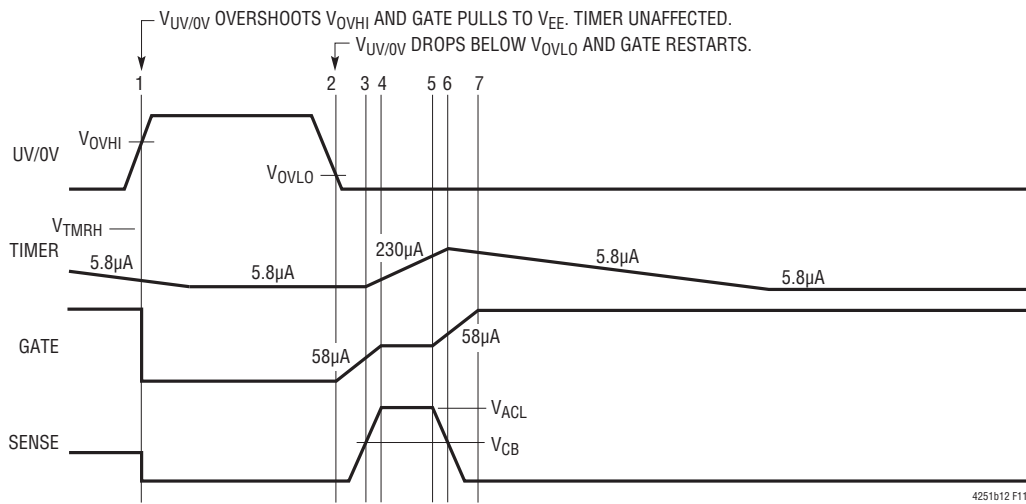
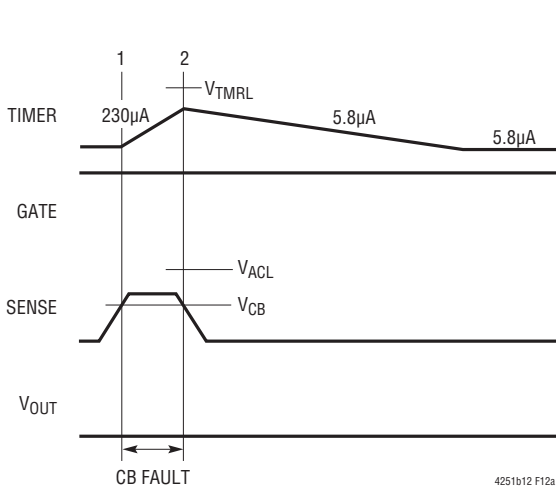
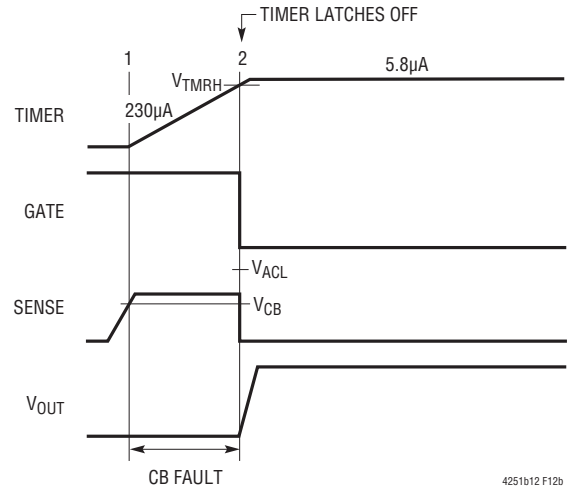

Figure 11. Overvoltage Timing (All Waveforms are Referenced to  $V_{EE}$ )

**APPLICATIONS INFORMATION**



**(12a) Momentary Circuit-Breaker Fault**



**(12b) Circuit-Breaker Time-Out**

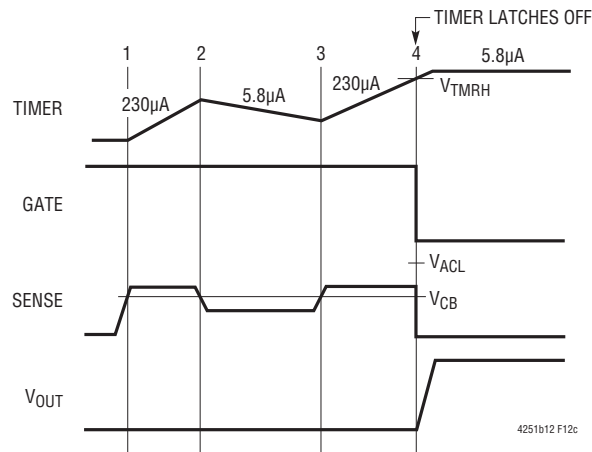

**(12c) Multiple Circuit-Breaker Faults**

**Figure 12. Timer Behavior (All Waveforms are Referenced to V<sub>EE</sub>)**

## APPLICATIONS INFORMATION

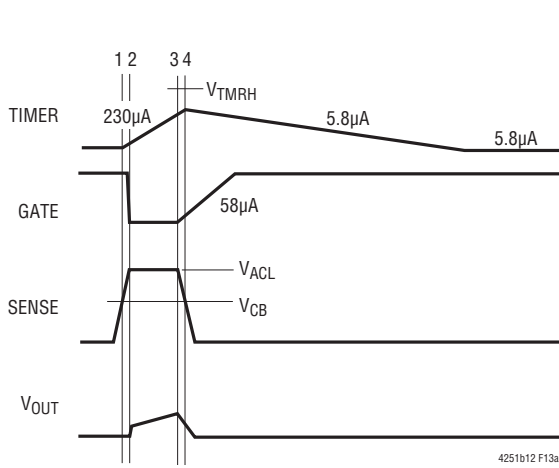

(13a) Analog Current Limit Fault

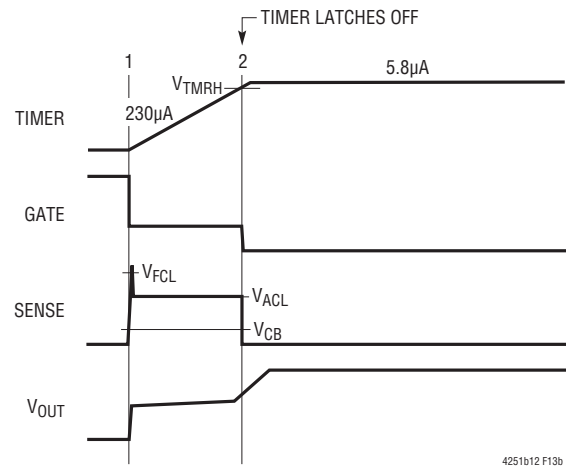

(13b) Fast Current Limit Fault

Figure 13. Current Limit Behavior (All Waveforms are Referenced to  $V_{EE}$ )

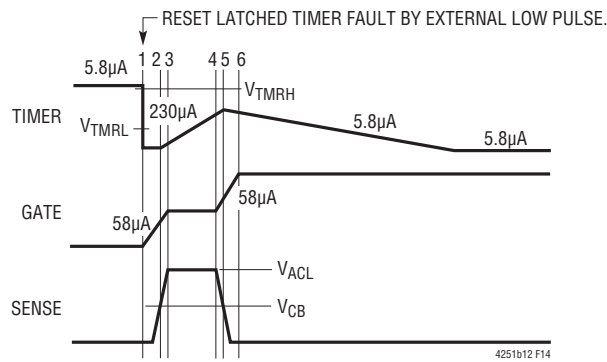

Figure 14. Latched Fault Reset Timing (All Waveforms are Referenced to  $V_{EE}$ )

## APPLICATIONS INFORMATION

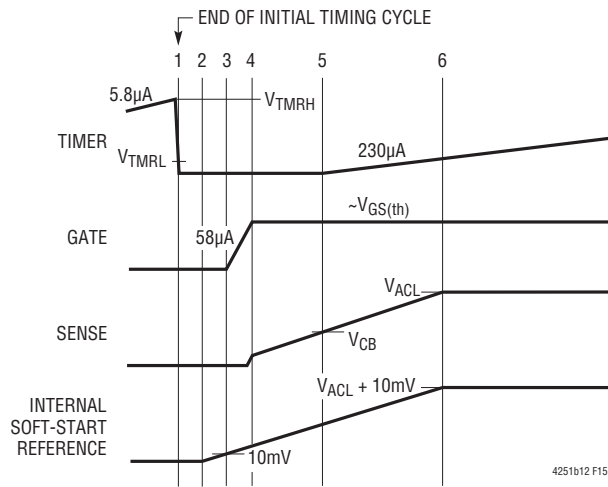
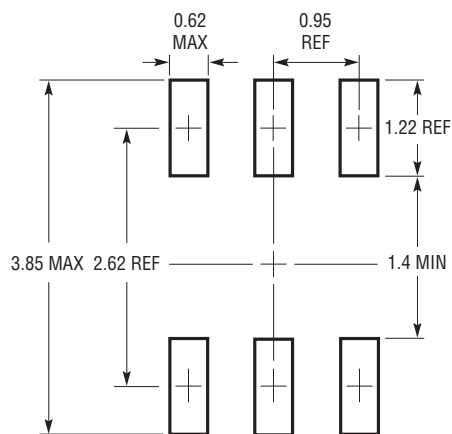

Figure 15. Internal Soft-Start Timing (All Waveforms are Referenced to  $V_{\text{EE}}$ )

## PACKAGE DESCRIPTION

Please refer to <http://www.linear.com/designtools/packaging/> for the most recent package drawings.

**S6 Package**  
**6-Lead Plastic TSOT-23**  
(Reference LTC DWG # 05-08-1636)



RECOMMENDED SOLDER PAD LAYOUT  
PER IPC CALCULATOR

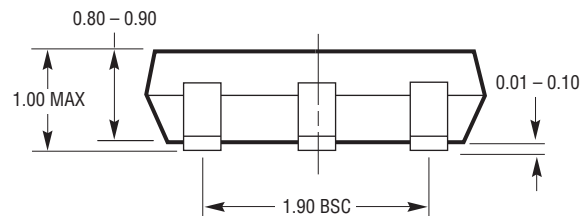
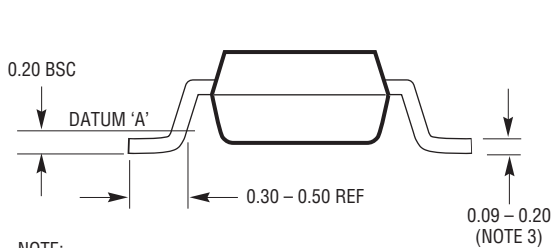
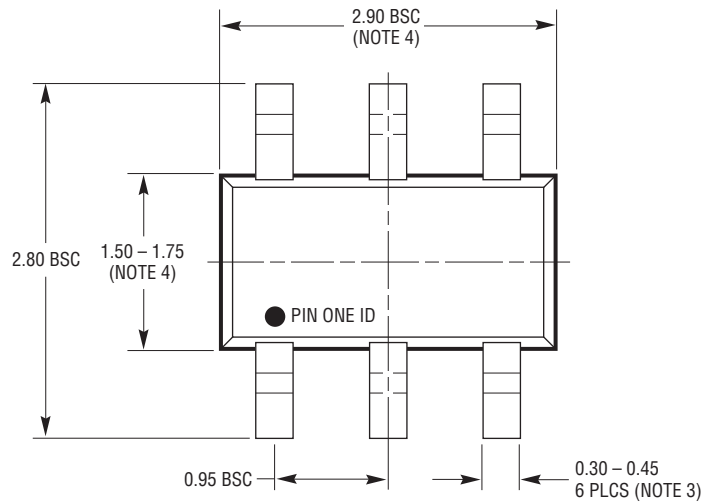

S6 TSOT-23 0302 REV B

**NOTE:**

1. DIMENSIONS ARE IN MILLIMETERS
2. DRAWING NOT TO SCALE
3. DIMENSIONS ARE INCLUSIVE OF PLATING
4. DIMENSIONS ARE EXCLUSIVE OF MOLD FLASH AND METAL BURR
5. MOLD FLASH SHALL NOT EXCEED 0.254mm
6. JEDEC PACKAGE REFERENCE IS MO-193

# LTC4251B/LTC4251B-1/ LTC4251B-2

## TYPICAL APPLICATIONS

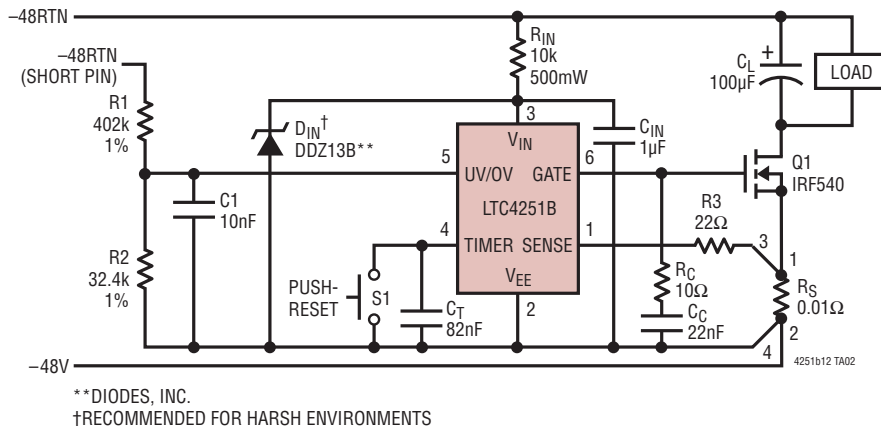

Figure 16. -48V/5A Application with Reverse SENSE Pin Limiting and Push-Reset at TIMER Pin

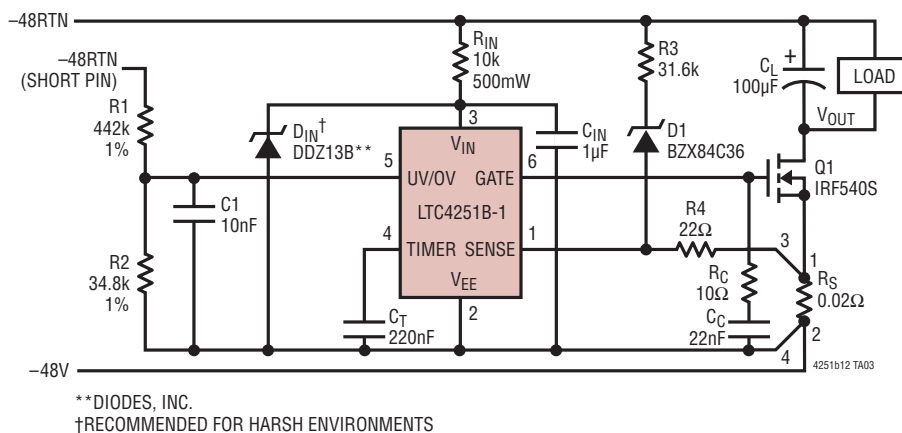

Figure 17. Power-Limited Circuit Breaker Application

## RELATED PARTS

PART NUMBER	DESCRIPTION	COMMENTS
LT1640AH/LT1640AL	Negative High Voltage Hot Swap Controllers in SO-8	Negative High Voltage Supplies from -10V to -80V
LT1641-1/LT1641-2	Positive High Voltage Hot Swap Controllers in SO-8	Supplies from 9V to 80V, Latched Off/Autoretry
LTC1642	Fault Protected Hot Swap Controller	3V to 16.5V, Overvoltage Protection up to 33V
LTC1921	Dual -48V Supply and Fuse Monitor	±1V UV and ±1.5V OV Threshold Accuracy, ±200V Transient Protection, Drives Three Optoisolators for Status
LT4250	-48V Hot Swap Controller in SO-8	Active Current Limiting, Supplies from -20V to -80V
LTC4252B-1/ LTC4252B-2	Negative Voltage Hot Swap Controller in MSOP	Fast Active Current Limiting with Drain Accelerated Response, Supplies from -15V
LTC4253B	Negative Voltage Hot Swap Controller with 3-Output Sequencer	Fast Active Current Limiting with Drain Accelerated Response, Supplies from -15V

4251b12f