

FEATURES

- Conversion gain: 12.5 dB typical**
- Image rejection: 28 dBc typical**
- Noise figure: 5 dB typical**
- Input power for 1 dB compression (P1dB): -9 dBm typical**
- Input third-order intercept (IP3): -1 dBm typical**
- Input second-order intercept (IP2): 20 dBm typical**
- 6× local oscillator (LO) leakage at RFIN: -40 dBm typical**
- 1× LO leakage at IFOUT: -50 dBm typical**
- Radio frequency (RF) return loss: 5 dB typical**
- LO return loss: 20 dB typical**
- Die size: 3.599 mm × 2.199 mm × 0.05 mm**

APPLICATIONS

- E-band communication systems**
- High capacity wireless backhauls**
- Test and measurement**

GENERAL DESCRIPTION

The **HMC7586** is an integrated E-band gallium arsenide (GaAs), monolithic microwave integrated circuit (MMIC) in-phase/quadrature (I/Q) downconverter chip that operates from 71 GHz to 76 GHz. The **HMC7586** provides a small signal conversion gain of 12.5 dB with 28 dBc of image rejection across the frequency band. The device uses a low noise amplifier followed by an image rejection mixer that is driven by a 6× LO multiplier.

The image rejection mixer eliminates the need for a filter following the low noise amplifier. Differential I and Q mixer outputs are provided for direct conversion applications. Alternatively, the outputs can be combined using an external 90° hybrid and two external 180° hybrids for single-sideband applications. All data includes the effect of a 1 mil gold wire wedge bond on the intermediate frequency (IF) ports.

FUNCTIONAL BLOCK DIAGRAM

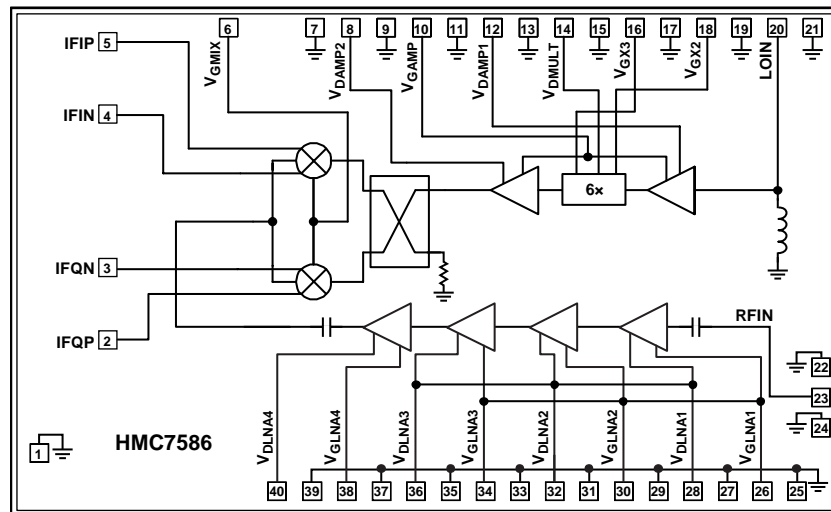

Figure 1.

TABLE OF CONTENTS

Features	1	Spurious Performance With Lower Sideband Selected, IF = 500 MHz	44
Applications.....	1	Spurious Performance With Lower Sideband Selected, IF = 1000 MHz.....	45
General Description	1	Spurious Performance With Lower Sideband Selected, IF = 2000 MHz	46
Functional Block Diagram	1	Spurious Performance with Upper Sideband Selected, IF = 500 MHz	47
Revision History	2	Spurious Performance with Upper Sideband Selected, IF = 1000 MHz.....	48
Specifications.....	3	Spurious Performance with Upper Sideband Selected, IF = 2000 MHz.....	49
Absolute Maximum Ratings.....	4	Theory of Operation	50
Thermal Resistance	4	Applications Information	51
ESD Caution.....	4	Biasing Sequence	51
Pin Configuration and Function Descriptions.....	5	Image Rejection Downconversion.....	51
Interface Schematics.....	6	Zero IF Direct Conversion.....	52
Typical Performance Characteristics	7	Assembly Diagram	53
Lower Sideband Selected, IF = 1000 MHz	7	Mounting and Bonding Techniques for Millimeterwave GaAs MMICs.....	54
Return Loss Performance.....	12	Handling Precautions	54
Lower Sideband Selected, IF = 500 MHz	13	Mounting	54
Lower Sideband Selected, IF = 2000 MHz.....	18	Wire Bonding.....	54
Noise Figure Performance, Lower Sideband Selected	23	Outline Dimensions	55
Amplitude Balance Performance, Lower Sideband Selected	24	Ordering Guide	55
Phase Balance Performance, Lower Sideband Selected	25		
Upper Sideband Selected, IF = 500 MHz	26		
Upper Sideband Selected, IF = 1000 MHz.....	31		
Upper Sideband Selected, IF = 2000 MHz	36		
Noise Figure Performance, Upper Sideband Selected	41		
Amplitude Balance Performance, Upper Sideband Selected	42		
Phase Balance Performance, Upper Sideband Selected	43		

REVISION HISTORY

3/16—Revision A: Initial Version

SPECIFICATIONS

$T_A = 25^\circ\text{C}$, $IF = 1000\text{ MHz}$, $V_{\text{GMIX}} = -1\text{ V}$, $V_{\text{DAMPx}} = 4\text{ V}$, $V_{\text{DMULT}} = 1.5\text{ V}$, voltage on the V_{DLNax} pins ($V_{\text{DLNA}} = 3\text{ V}$, $LO = 2\text{ dBm}$, lower sideband selected. Measurements performed as a downconverter with external 90° and 180° hybrids at the IF ports, unless otherwise noted.

Table 1.

Parameter	Test Conditions/Comments	Min	Typ	Max	Unit
OPERATING CONDITIONS					
RF Frequency Range		71		76	GHz
LO Frequency Range		11.83		14.33	GHz
IF Frequency Range		0		10	GHz
LO Drive Range		2		8	dBm
PERFORMANCE					
Conversion Gain		8	12.5		dB
Image Rejection		20	28		dBc
Input Third-Order Intercept (IP3)			-1		dBm
Input Second-Order Intercept (IP2)			20		dBm
Input Power for 1 dB Compression (P1dB)	$V_{\text{DLNax}} = 4\text{ V}$		-9		dBm
6× LO Leakage at RF Input (RFIN)			-40		dBm
1× LO Leakage at IF Output (IFOUT)			-50		dBm
Amplitude Balance ¹			-0.4		dB
Phase Balance ¹			±4		Degrees
Noise Figure			5		dB
RF Return Loss			5		dB
LO Return Loss	$V_{\text{DLNax}} = 4\text{ V}$		20		dB
IF Return Loss ¹	$V_{\text{DLNax}} = 4\text{ V}$		25		dB
POWER SUPPLY					
Supply Current					
I_{DAMP}^2			175		mA
I_{DMULT}^3	Under LO drive		80		mA
I_{DLNA}^4			50		mA

¹ Measurements performed without external hybrids at the IF ports.

² Adjust V_{GAMP} between -2 V and 0 V to achieve the total quiescent current, $I_{\text{DAMP}} = I_{\text{DAMP1}} + I_{\text{DAMP2}} = 175\text{ mA}$.

³ Adjust V_{GX2} and V_{GX3} between -2 V and 0 V to achieve the total quiescent current, $I_{\text{DMULT}} = 1\text{ mA}$ to 2 mA . See the Applications Information section for more information.

⁴ Adjust V_{GLNax} between -2 V and 0 V to achieve the total quiescent current, $I_{\text{DLNA1}} + I_{\text{DLNA2}} + I_{\text{DLNA3}} + I_{\text{DLNA4}} = 50\text{ mA}$.

ABSOLUTE MAXIMUM RATINGS

Table 2.

Parameter	Rating
Drain Bias Voltage	
V_{DAMP1}, V_{DAMP2}	4.5 V
V_{DMULT}	3 V
$V_{DLNA1}, V_{DLNA2}, V_{DLNA3}, V_{DLNA4}$	4.5 V
Gate Bias Voltage	
V_{GAMP}	-3 V to 0 V
V_{GX2}, V_{GX3}	-3 V to 0 V
$V_{GLNA1}, V_{GLNA2}, V_{GLNA3}, V_{GLNA4}$	-3 V to 0 V
V_{GMIX}	-3 V to 0 V
LO Input Power	10 dBm
Maximum Junction Temperature (to Maintain 1 Million Hours Mean Time to Failure (MTTF))	175°C
Storage Temperature Range	-65°C to +150°C
Operating Temperature Range	-55°C to +85°C
ESD Sensitivity, Human Body Model (HBM)	100 V (Class 0)

Stresses at or above those listed under Absolute Maximum Ratings may cause permanent damage to the product. This is a stress rating only; functional operation of the product at these or any other conditions above those indicated in the operational section of this specification is not implied. Operation beyond the maximum operating conditions for extended periods may affect product reliability.

THERMAL RESISTANCE

Table 3. Thermal Resistance

Package Type	θ_{JC}^1	Unit
40-Pad Bare Die [CHIP]	61.7	°C/W

¹ Based on ABLEBOND® 84-1LMIT as die attach epoxy with a thermal conductivity of 3.6 W/mK.

ESD CAUTION



ESD (electrostatic discharge) sensitive device. Charged devices and circuit boards can discharge without detection. Although this product features patented or proprietary protection circuitry, damage may occur on devices subjected to high energy ESD. Therefore, proper ESD precautions should be taken to avoid performance degradation or loss of functionality.

PIN CONFIGURATION AND FUNCTION DESCRIPTIONS

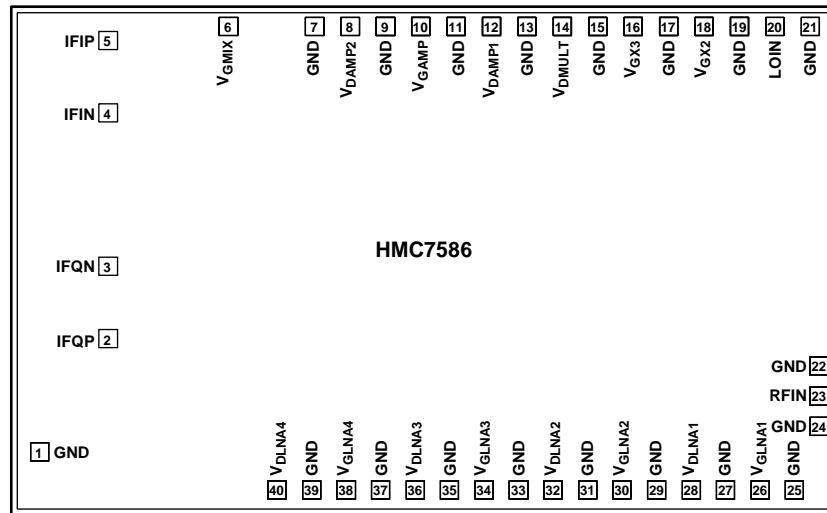

Figure 2. Pad Configuration

Table 4. Pad Function Descriptions

Pad No.	Mnemonic	Description
1, 7, 9, 11, 13, 15, 17, 19, 21, 22, 24, 25, 27, 29, 31, 33, 35, 37, 39	GND	Ground Connect. See Figure 3.
2, 3	IFQP, IFQN	Positive and Negative IF Q Outputs. These pads are dc-coupled. When operation to dc is not required, block these pads externally using a series capacitor with a value chosen to pass the necessary frequency range. For operation to dc, these pads must not source or sink more than 3 mA of current or die malfunction and die failure may result (see Figure 4).
4, 5	IFIN, IFIP	Negative and Positive IF I Outputs. These pads are dc-coupled. When operation to dc is not required, block these pads externally using a series capacitor with a value chosen to pass the necessary frequency range. For operation to dc, these pads must not source or sink more than 3 mA of current or die malfunction and die failure may result (see Figure 4).
6	V _{GMIX}	Gate Voltage for the FET Mixer. See Figure 5. Refer to the typical application circuit for required external components (see Figure 211).
8, 12	V _{DAMP2} , V _{DAMP1}	Power Supply Voltage for the First and the Second Stage LO Amplifier. See Figure 5. Refer to the typical application circuit for required external components (see Figure 211).
10	V _{GAMP}	Gate Voltage for the First and the Second Stage LO Amplifier. See Figure 5. Refer to the typical application circuit for required external components (see Figure 211).
14	V _{DMULT}	Power Supply Voltage for the LO Multiplier. See Figure 5. Refer to the typical application circuit for required external components (see Figure 211).
16, 18	V _{GX3} , V _{GX2}	Gate Voltage for the LO Multiplier. See Figure 5. Refer to the typical application circuit for required external components (see Figure 211).
20	LOIN	Local Oscillator Input. This pad is dc-coupled and matched to 50 Ω (see Figure 6).
23	RFIN	RF Input. This pad is ac-coupled and matched to 50 Ω (see Figure 7).
26, 30, 34, 38	V _{GLNA1} , V _{GLNA2} , V _{GLNA3} , V _{GLNA4}	Gate Voltage for the Low Noise Amplifier. See Figure 8. Refer to the typical application circuit for required external components (see Figure 211).
28, 32, 36, 40	V _{DLNA1} , V _{DLNA2} , V _{DLNA3} , V _{DLNA4}	Power Supply Voltage for the Low Noise Amplifier. See Figure 8. Refer to the typical application circuit for required external components (see Figure 211).
Die Bottom	GND	Ground. Die bottom must be connected to RF/dc ground (see Figure 3).

INTERFACE SCHEMATICS



Figure 3. GND Interface

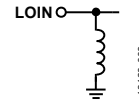

Figure 6. LOIN Interface

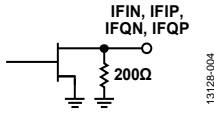

Figure 4. IFIP, IFIN, IFQN, IFQP, and V_{GMIX} Interface

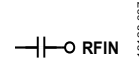

Figure 7. RFIN Interface

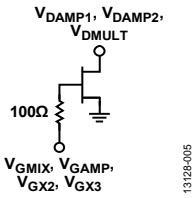

Figure 5. V_{DAMP1} , V_{DAMP2} , V_{DMULT} , V_{GAMP} , V_{GMIX} , V_{GX2} , and V_{GX3} Interface

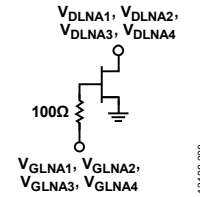

Figure 8. V_{DLNA1} , V_{DLNA2} , V_{DLNA3} , V_{DLNA4} , V_{GLNA1} , V_{GLNA2} , V_{GLNA3} , and V_{GLNA4} Interface

TYPICAL PERFORMANCE CHARACTERISTICS

LOWER SIDEBAND SELECTED, IF = 1000 MHz

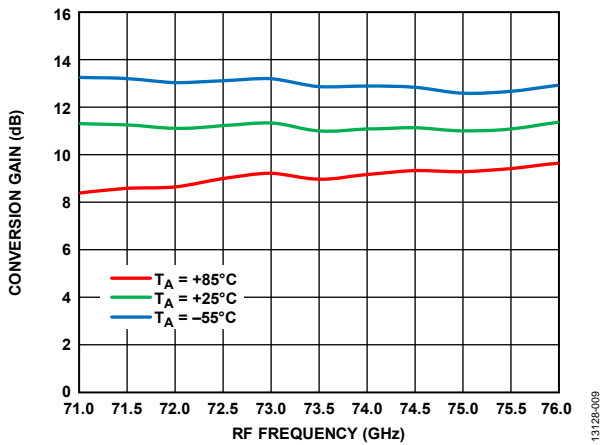

Figure 9. Conversion Gain vs. RF Frequency at Various Temperatures, $RFIN = -20\text{ dBm}$, $LO = 2\text{ dBm}$, $IF = 1000\text{ MHz}$, $V_{DLNA} = 4\text{ V}$

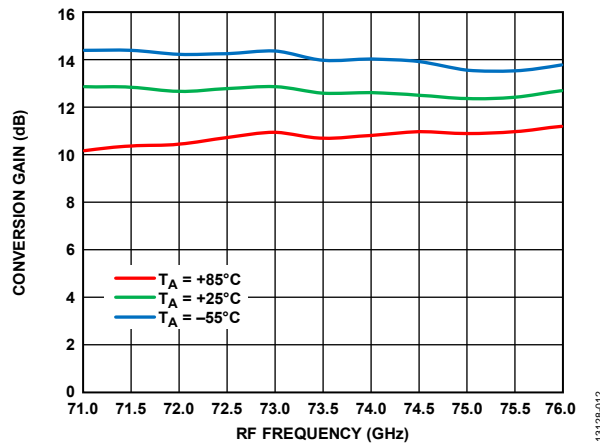

Figure 12. Conversion Gain vs. RF Frequency at Various Temperatures, $RFIN = -20\text{ dBm}$, $LO = 2\text{ dBm}$, $IF = 1000\text{ MHz}$, $V_{DLNA} = 3\text{ V}$

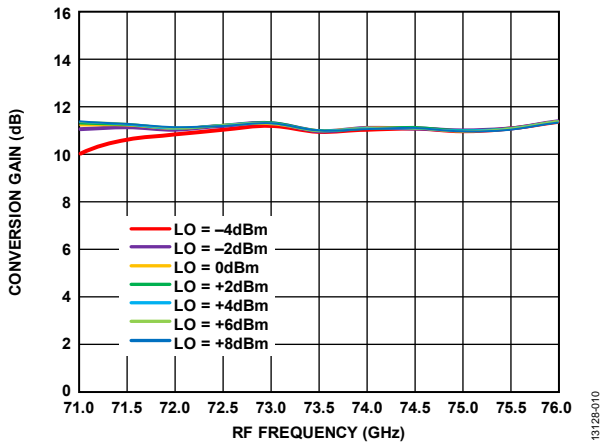

Figure 10. Conversion Gain vs. RF Frequency at Various LO Powers, $RFIN = -20\text{ dBm}$, $IF = 1000\text{ MHz}$, $V_{DLNA} = 4\text{ V}$

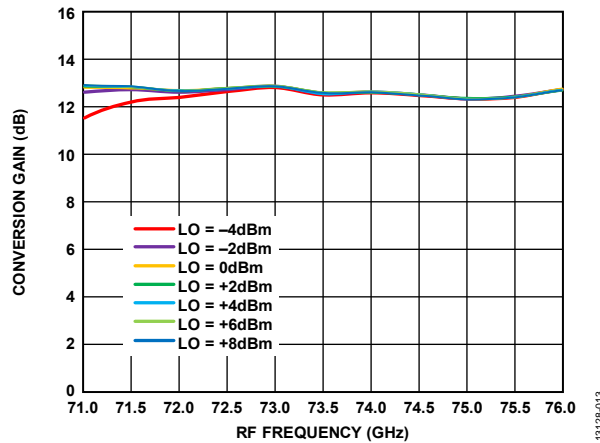

Figure 13. Conversion Gain vs. RF Frequency at Various LO Powers, $RFIN = -20\text{ dBm}$, $IF = 1000\text{ MHz}$, $V_{DLNA} = 3\text{ V}$

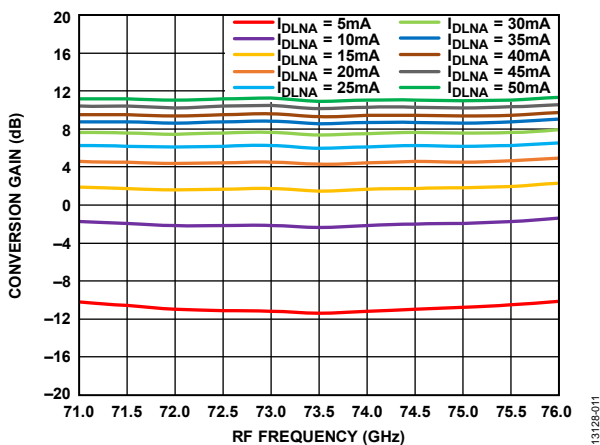

Figure 11. Conversion Gain vs. RF Frequency at Various I_{DLNA} Values, $RFIN = -20\text{ dBm}$, $IF = 1000\text{ MHz}$, $V_{DLNA} = 4\text{ V}$

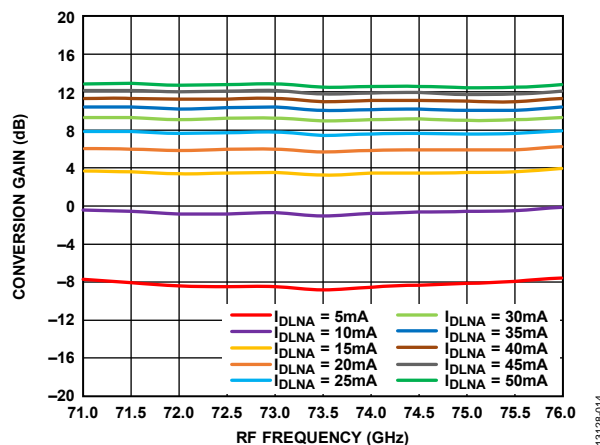

Figure 14. Conversion Gain vs. RF Frequency at Various I_{DLNA} Values, $RFIN = -20\text{ dBm}$, $IF = 1000\text{ MHz}$, $V_{DLNA} = 3\text{ V}$

13128-009

13128-012

13128-010

13128-013

13128-011

13128-014

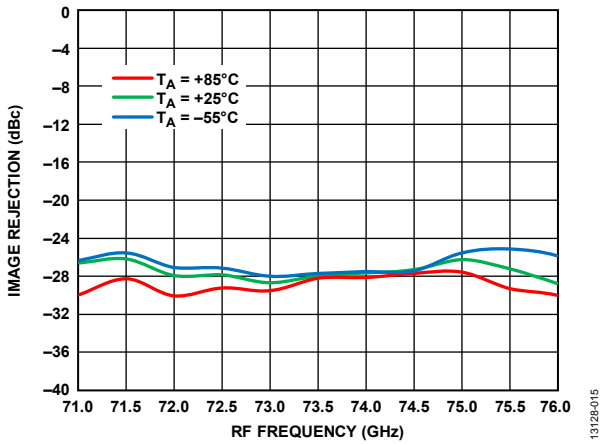

Figure 15. Image Rejection vs. RF Frequency at Various Temperatures, $R_{FIN} = -20$ dBm, $LO = 2$ dBm, $IF = 1000$ MHz, $V_{DLNA} = 4$ V

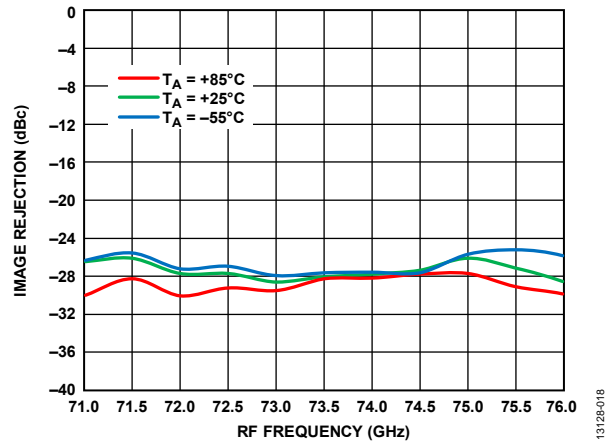

Figure 18. Image Rejection vs. RF Frequency at Various Temperatures, $R_{FIN} = -20$ dBm, $LO = 2$ dBm, $IF = 1000$ MHz, $V_{DLNA} = 3$ V

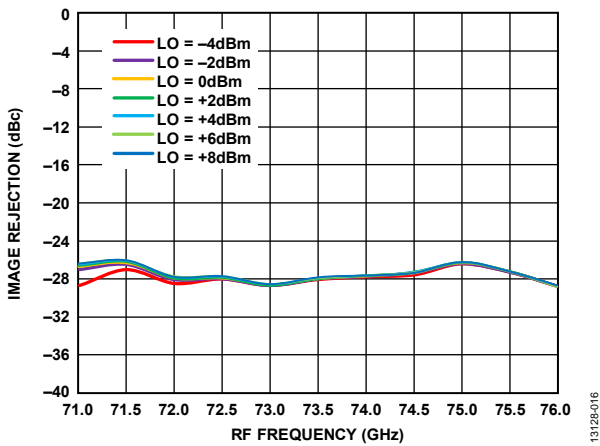

Figure 16. Image Rejection vs. RF Frequency at Various LO Powers, $R_{FIN} = -20$ dBm, $IF = 1000$ MHz, $V_{DLNA} = 4$ V

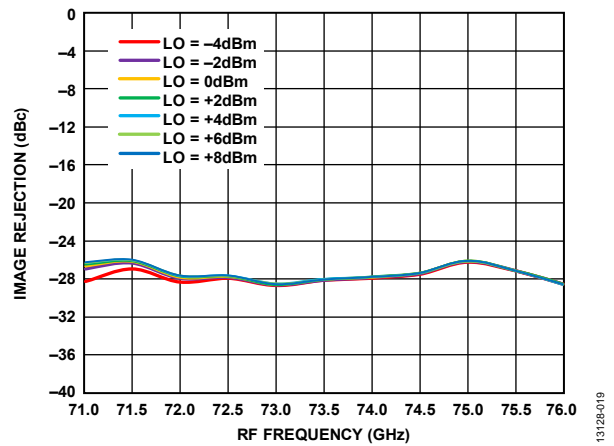

Figure 19. Image Rejection vs. RF Frequency at Various LO Powers, $R_{FIN} = -20$ dBm, $IF = 1000$ MHz, $V_{DLNA} = 3$ V

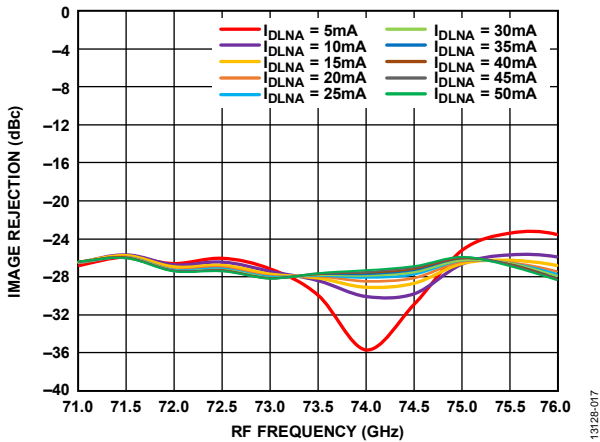

Figure 17. Image Rejection vs. RF Frequency at Various I_{DLNA} Values, $R_{FIN} = -20$ dBm, $LO = 2$ dBm, $IF = 1000$ MHz, $V_{DLNA} = 4$ V

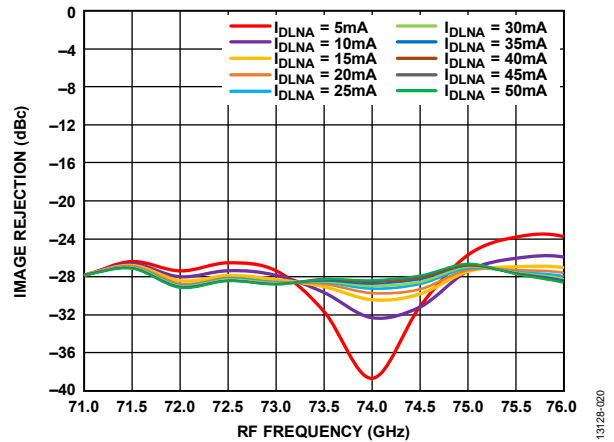

Figure 20. Image Rejection vs. RF Frequency at Various I_{DLNA} Values, $R_{FIN} = -20$ dBm, $LO = 2$ dBm, $IF = 1000$ MHz, $V_{DLNA} = 3$ V

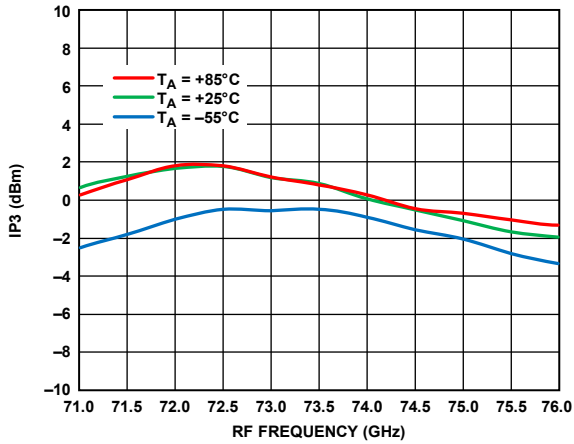

Figure 21. Input IP3 vs. RF Frequency at Various Temperatures, $R_{FIN} = -20$ dBm, $LO = 2$ dBm, $IF = 1000$ MHz, $V_{DLNA} = 4$ V

13128-021

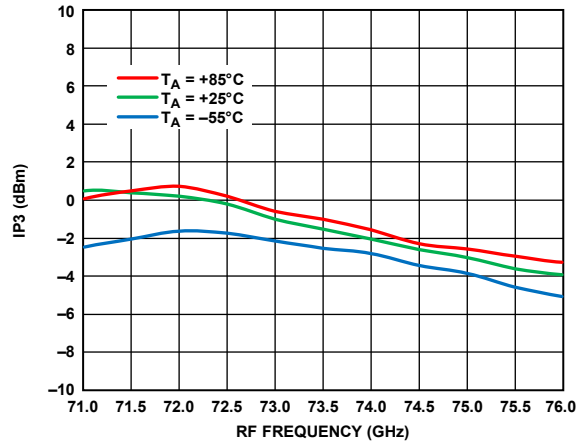

Figure 24. Input IP3 vs. RF Frequency at Various Temperatures, $R_{FIN} = -20$ dBm, $LO = 2$ dBm, $IF = 1000$ MHz, $V_{DLNA} = 3$ V

13128-024

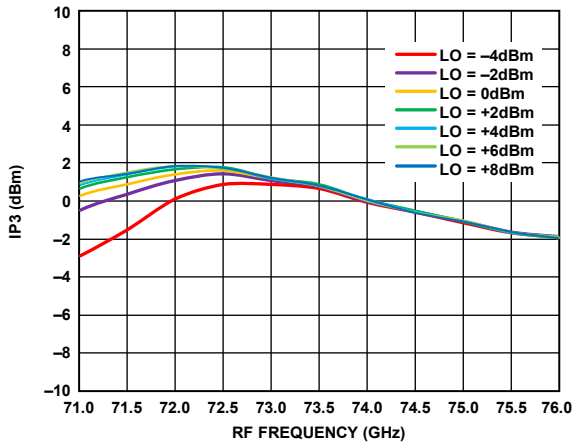

Figure 22. Input IP3 vs. RF Frequency at Various LO Powers, $R_{FIN} = -20$ dBm, $IF = 1000$ MHz, $V_{DLNA} = 4$ V

13128-022

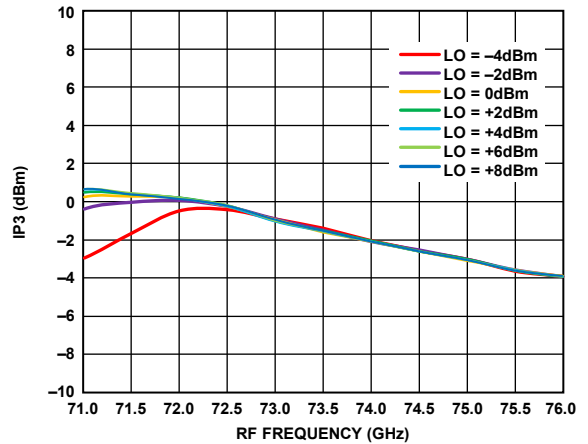

Figure 25. Input IP3 vs. RF Frequency at Various LO Powers, $R_{FIN} = -20$ dBm, $IF = 1000$ MHz, $V_{DLNA} = 3$ V

13128-025

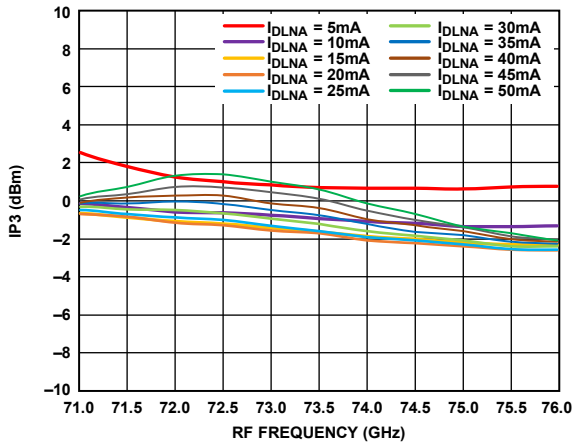

Figure 23. Input IP3 vs. RF Frequency at Various I_{DLNA} Values, $R_{FIN} = -20$ dBm, $LO = 2$ dBm, $IF = 1000$ MHz, $V_{DLNA} = 4$ V

13128-023

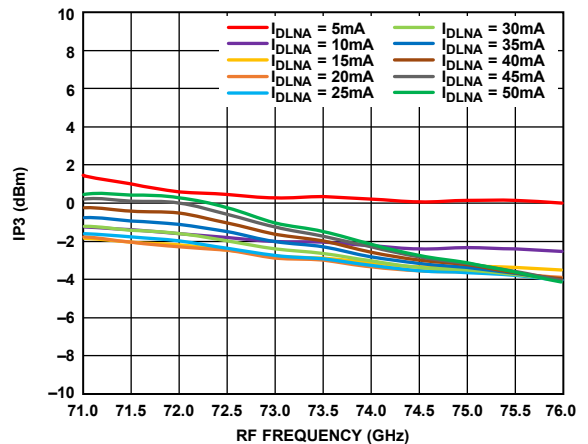

Figure 26. Input IP3 vs. RF Frequency at Various I_{DLNA} Values, $R_{FIN} = -20$ dBm, $LO = 2$ dBm, $IF = 1000$ MHz, $V_{DLNA} = 3$ V

13128-026

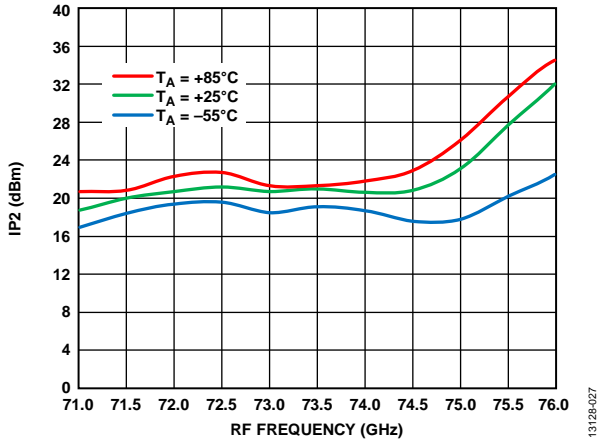

Figure 27. Input IP2 vs. RF Frequency at Various Temperatures, $R_{FIN} = -20$ dBm, $LO = 2$ dBm, $IF = 1000$ MHz, $V_{DLNA} = 4$ V

13128-027

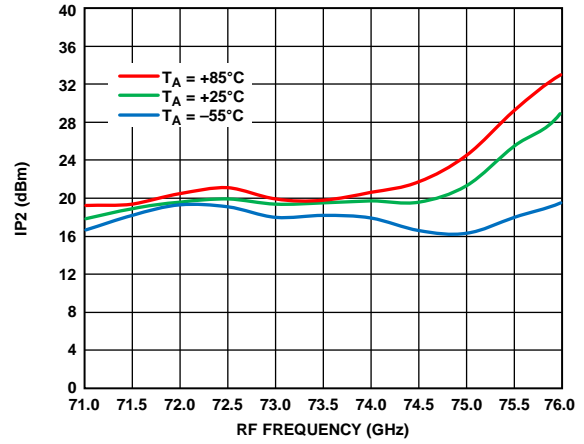

Figure 30. Input IP2 vs. RF Frequency at Various Temperatures, $R_{FIN} = -20$ dBm, $LO = 2$ dBm, $IF = 1000$ MHz, $V_{DLNA} = 3$ V

13128-030

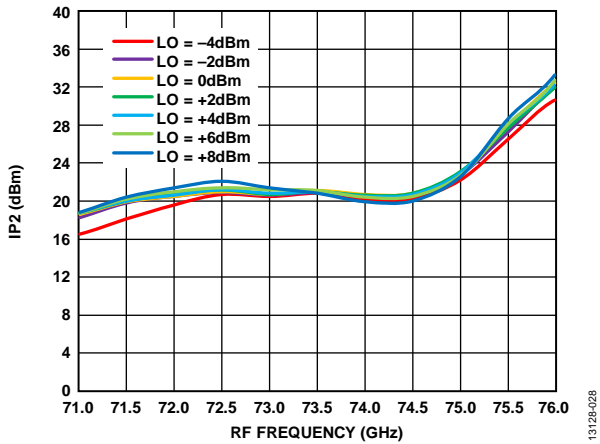

Figure 28. Input IP2 vs. RF Frequency at Various LO Powers, $R_{FIN} = -20$ dBm, $IF = 1000$ MHz, $V_{DLNA} = 4$ V

13128-028

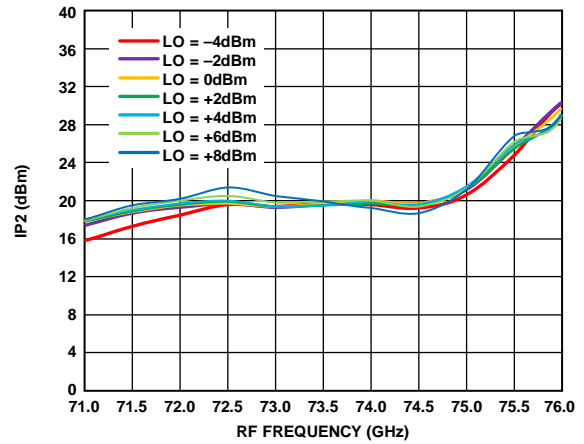

Figure 31. Input IP2 vs. RF Frequency at Various LO Powers, $R_{FIN} = -20$ dBm, $IF = 1000$ MHz, $V_{DLNA} = 3$ V

13128-031

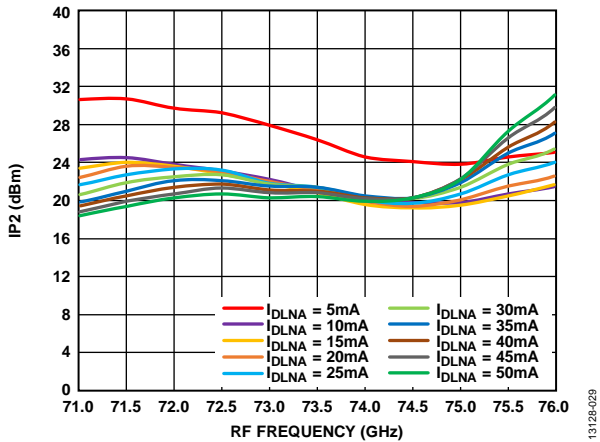

Figure 29. Input IP2 vs. RF Frequency at Various I_{DLNA} Values, $R_{FIN} = -20$ dBm, $LO = 2$ dBm, $IF = 1000$ MHz, $V_{DLNA} = 4$ V

13128-029

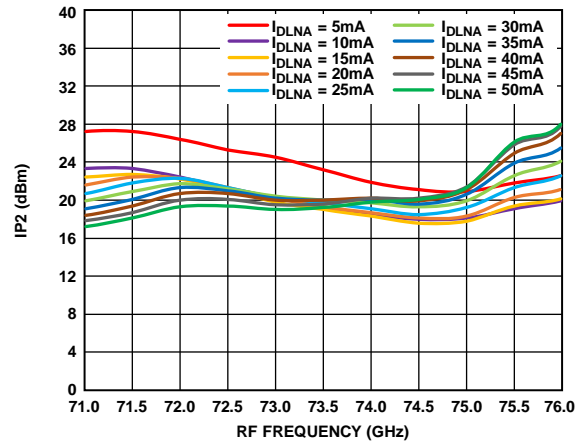

Figure 32. Input IP2 vs. RF Frequency at Various I_{DLNA} Values, $R_{FIN} = -20$ dBm, $LO = 2$ dBm, $IF = 1000$ MHz, $V_{DLNA} = 3$ V

13128-032

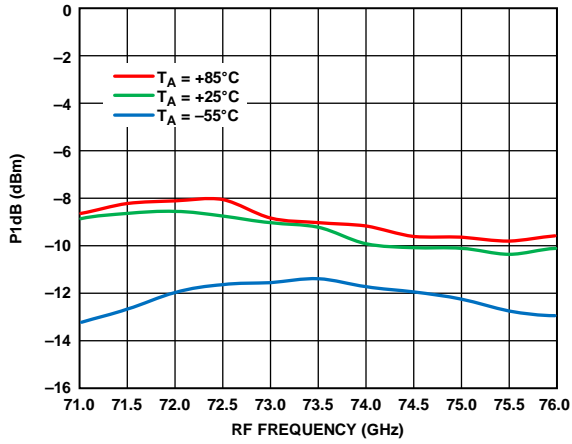

Figure 33. Input P1dB vs. RF Frequency at Various Temperatures, LO = 2 dBm, IF = 1000 MHz, V_{DLNA} = 4 V

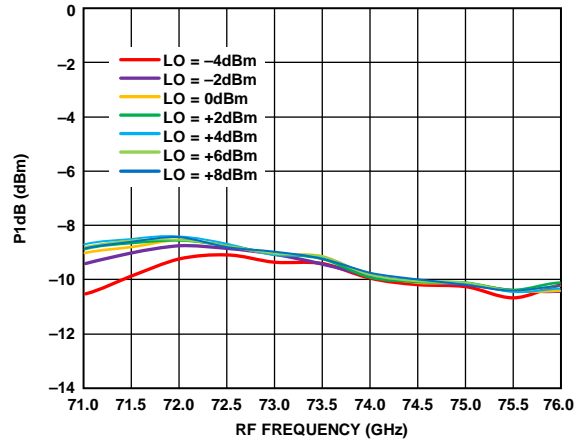

Figure 36. Input P1dB vs. RF Frequency at Various LO Powers, IF = 1000 MHz, V_{DLNA} = 4 V

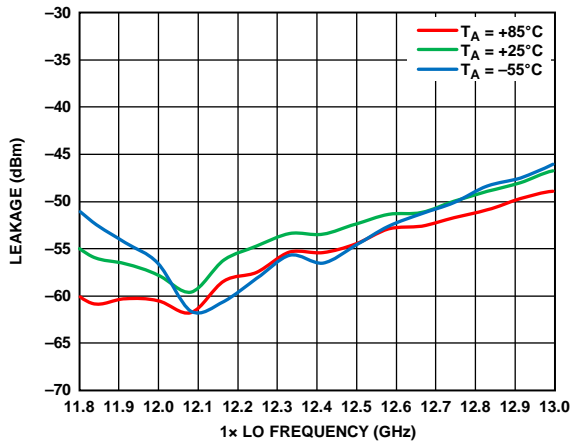

Figure 34. LO Leakage at IFOUT vs. 1x LO Frequency at Various Temperatures, LO = 2 dBm, V_{DLNA} = 3 V

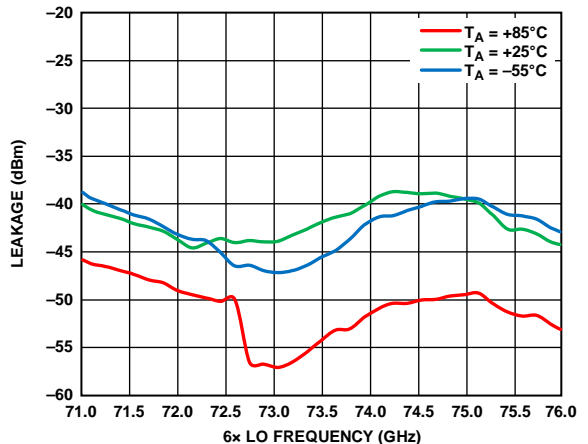

Figure 37. 6x LO Leakage at RFIN vs. 6x LO Frequency at Various Temperatures, LO = 2 dBm, V_{DLNA} = 3 V

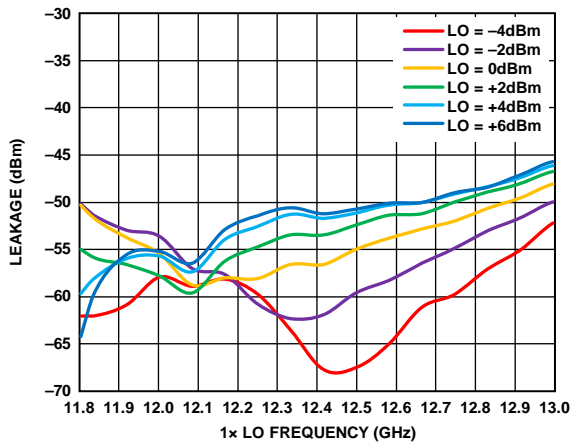

Figure 35. LO Leakage at IFOUT vs. 1x LO Frequency at Various LO Powers, V_{DLNA} = 3 V

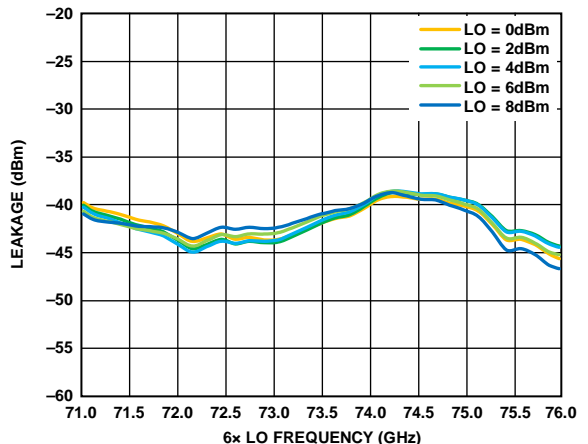

Figure 38. 6x LO Leakage at RFIN vs. 6x LO Frequency at Various LO Powers, V_{DLNA} = 3 V

RETURN LOSS PERFORMANCE

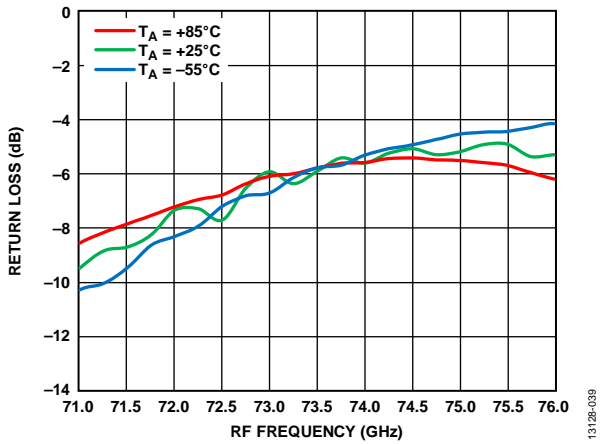

Figure 39. RF Return Loss vs. RF Frequency at Various Temperatures, LO = 2 dBm, LO = 12 GHz, V_{DLNA} = 4 V

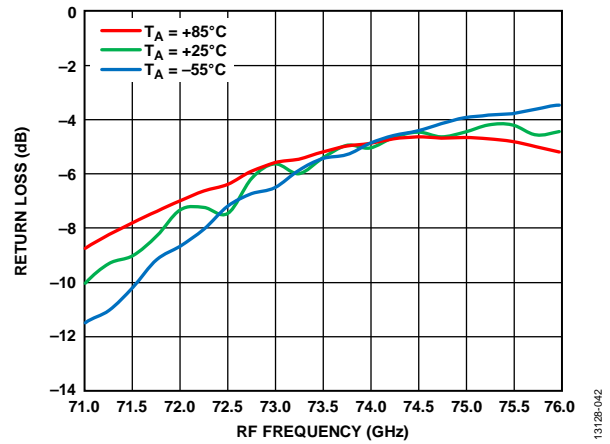

Figure 42. RF Return Loss vs. RF Frequency at Various Temperatures, LO = 2 dBm, LO = 12 GHz, V_{DLNA} = 3 V

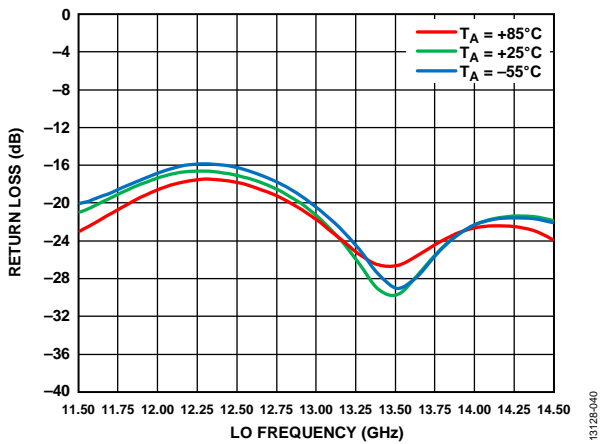

Figure 40. LO Return Loss vs. LO Frequency at Various Temperatures, LO = 2 dBm, V_{DLNA} = 4 V

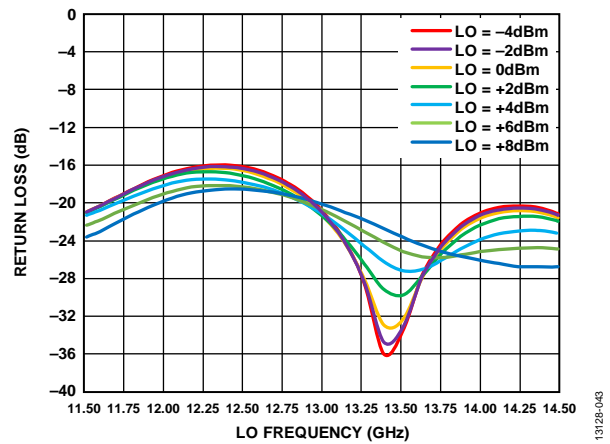

Figure 43. LO Return Loss vs. LO Frequency at Various LO Powers, V_{DLNA} = 4 V

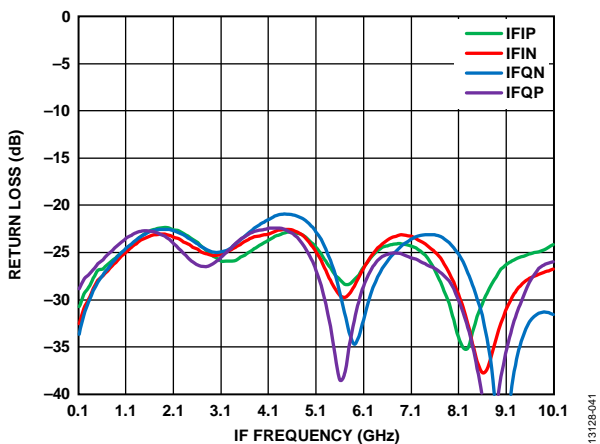

Figure 41. IF Return Loss vs. IF Frequency, LO = 2 dBm, LO = 12 GHz, V_{DLNA} = 4 V

LOWER SIDEBAND SELECTED, IF = 500 MHz

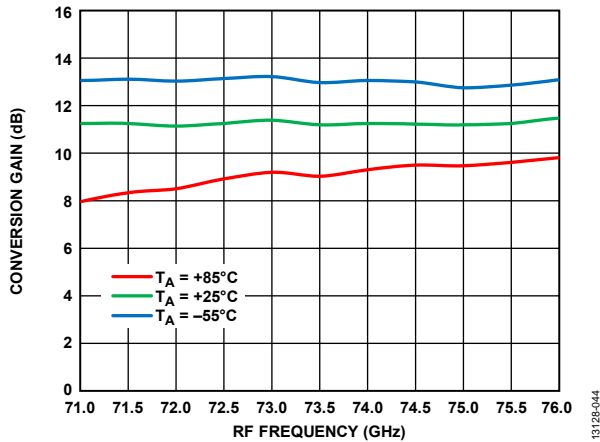

Figure 44. Conversion Gain vs. RF Frequency at Various Temperatures, $R_{FIN} = -20$ dBm, $L_O = 2$ dBm, $I_F = 500$ MHz, $V_{DLNA} = 4$ V

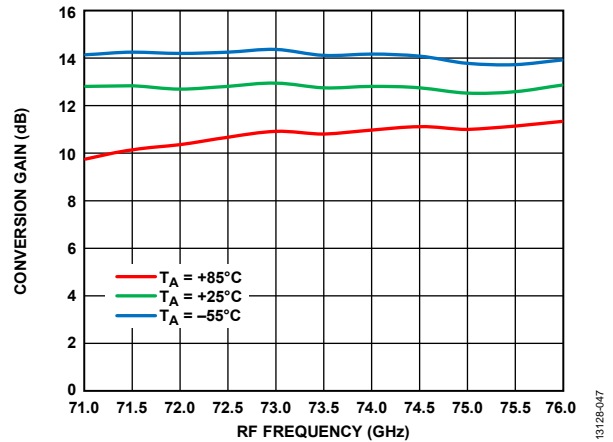

Figure 47. Conversion Gain vs. RF Frequency at Various Temperatures, $R_{FIN} = -20$ dBm, $L_O = 2$ dBm, $I_F = 500$ MHz, $V_{DLNA} = 3$ V

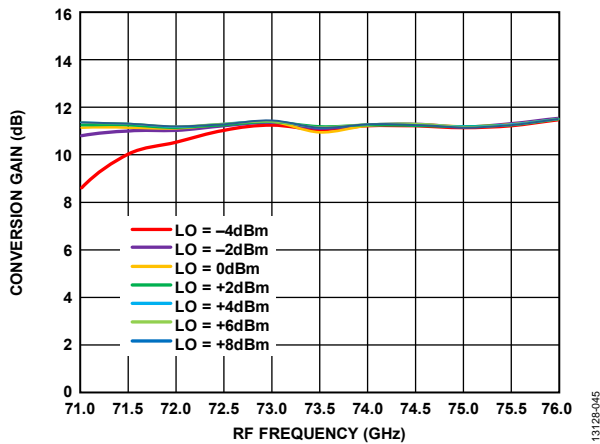

Figure 45. Conversion Gain vs. RF Frequency at Various LO Powers, $R_{FIN} = -20$ dBm, $I_F = 500$ MHz, $V_{DLNA} = 4$ V

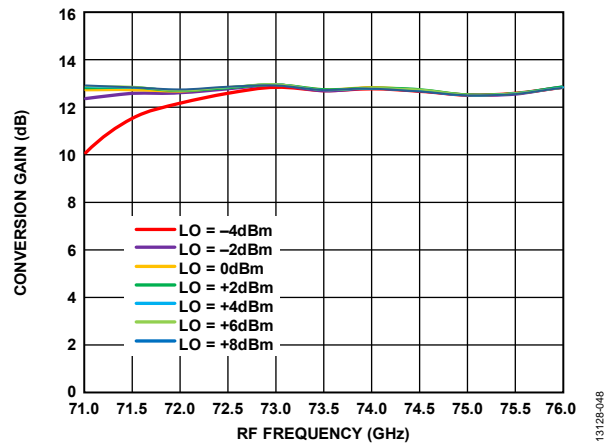

Figure 48. Conversion Gain vs. RF Frequency at Various LO Powers, $R_{FIN} = -20$ dBm, $I_F = 500$ MHz, $V_{DLNA} = 3$ V

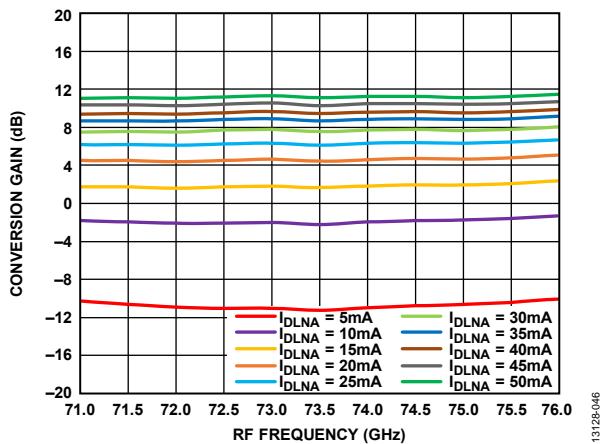

Figure 46. Conversion Gain vs. RF Frequency at Various I_{DLNA} Values, $R_{FIN} = -20$ dBm, $I_F = 500$ MHz, $V_{DLNA} = 4$ V

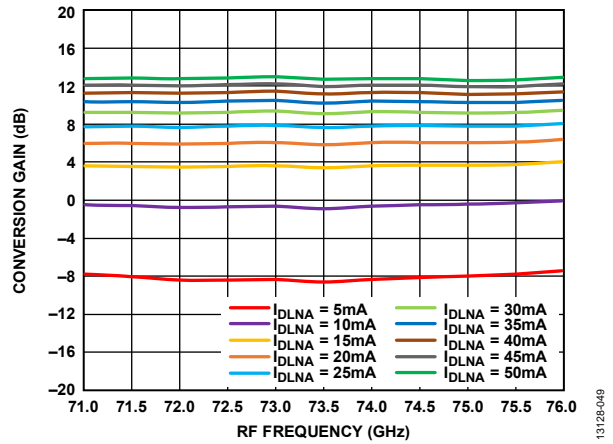
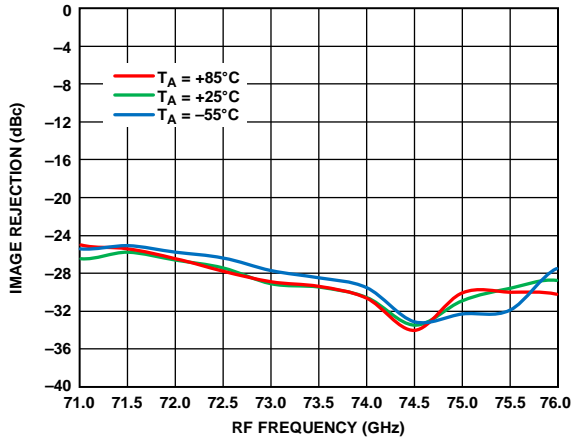
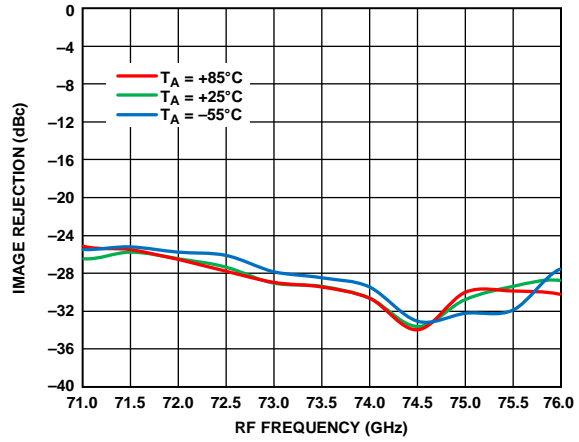

Figure 49. Conversion Gain vs. RF Frequency at Various I_{DLNA} Values, $R_{FIN} = -20$ dBm, $I_F = 500$ MHz, $V_{DLNA} = 3$ V



13128-050

Figure 50. Image Rejection vs. RF Frequency at Various Temperatures, $R_{FIN} = -20$ dBm, $LO = 2$ dBm, $IF = 500$ MHz, $V_{DLNA} = 4$ V



13128-053

Figure 53. Image Rejection vs. RF Frequency at Various Temperatures, $R_{FIN} = -20$ dBm, $LO = 2$ dBm, $IF = 500$ MHz, $V_{DLNA} = 3$ V

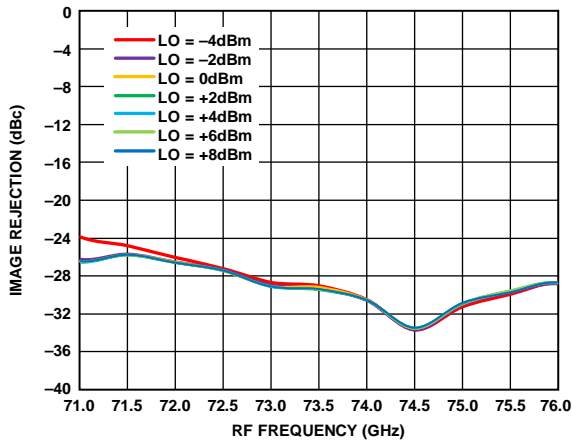

13128-051

Figure 51. Image Rejection vs. RF Frequency at Various LO Powers, $R_{FIN} = -20$ dBm, $IF = 500$ MHz, $V_{DLNA} = 4$ V

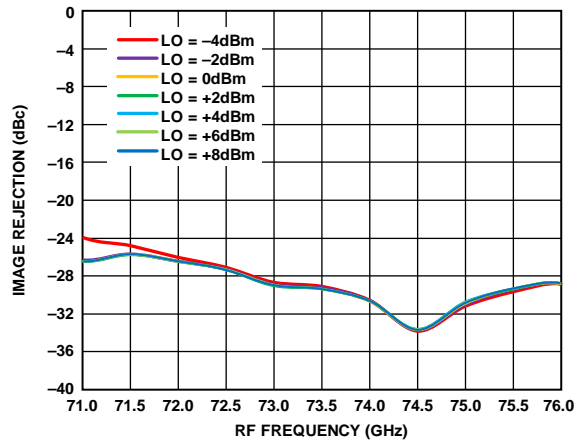

13128-054

Figure 54. Image Rejection vs. RF Frequency at Various LO Powers, $R_{FIN} = -20$ dBm, $IF = 500$ MHz, $V_{DLNA} = 3$ V

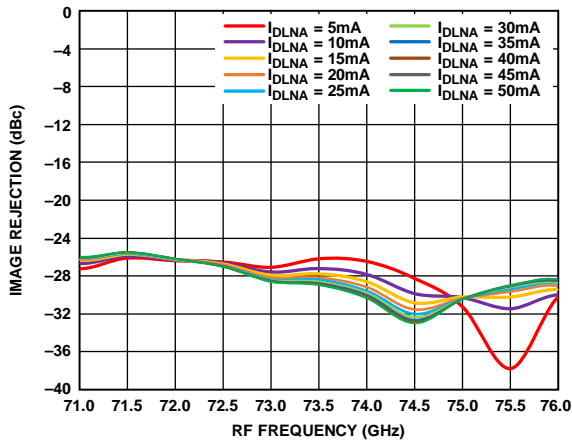

13128-052

Figure 52. Image Rejection vs. RF Frequency at Various I_{DLNA} Values, $R_{FIN} = -20$ dBm, $LO = 2$ dBm, $IF = 500$ MHz, $V_{DLNA} = 4$ V

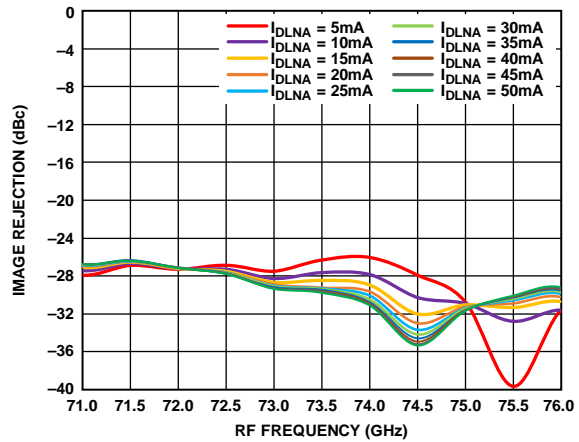

13128-055

Figure 55. Image Rejection vs. RF Frequency at Various I_{DLNA} Values, $R_{FIN} = -20$ dBm, $LO = 2$ dBm, $IF = 500$ MHz, $V_{DLNA} = 3$ V

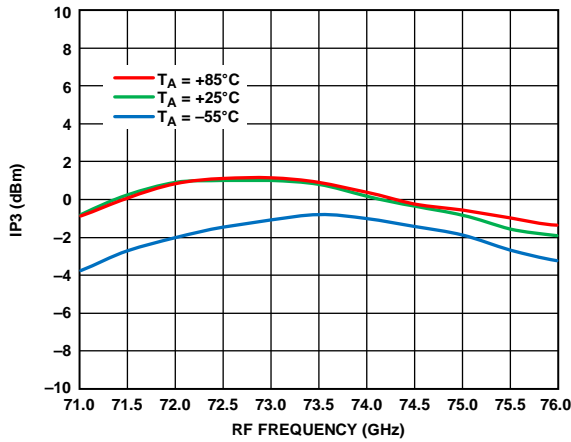

Figure 56. Input IP3 vs. RF Frequency at Various Temperatures, $R_{FIN} = -20$ dBm, $LO = 2$ dBm, $IF = 500$ MHz, $V_{DLNA} = 4$ V

13128-056

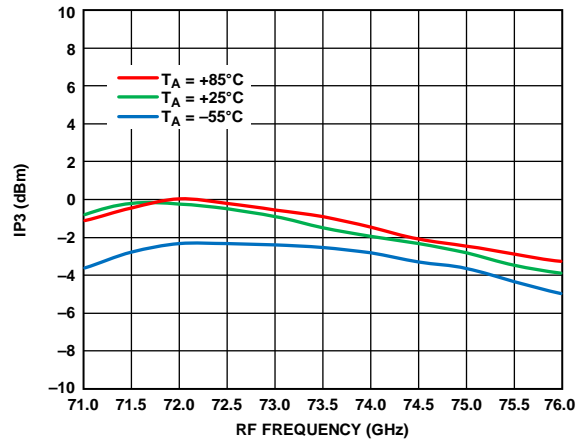

Figure 59. Input IP3 vs. RF Frequency at Various Temperatures, $R_{FIN} = -20$ dBm, $LO = 2$ dBm, $IF = 500$ MHz, $V_{DLNA} = 3$ V

13128-059

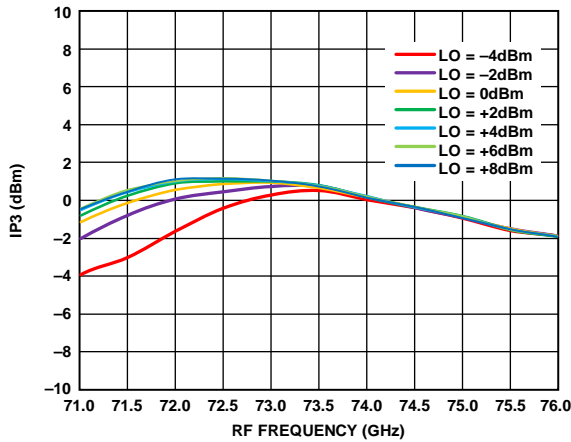

Figure 57. Input IP3 vs. RF Frequency at Various LO Powers, $R_{FIN} = -20$ dBm, $IF = 500$ MHz, $V_{DLNA} = 4$ V

13128-057

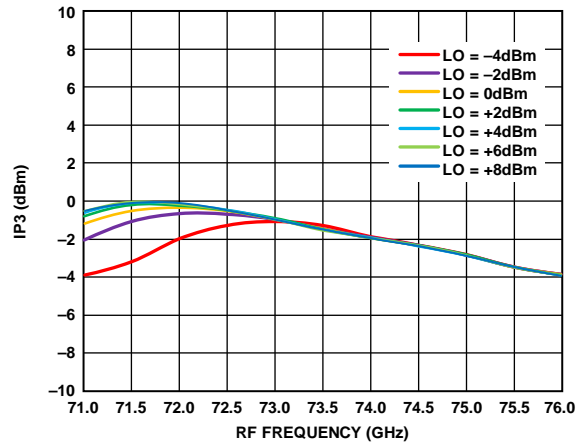

Figure 60. Input IP3 vs. RF Frequency at Various LO Powers, $R_{FIN} = -20$ dBm, $IF = 500$ MHz, $V_{DLNA} = 3$ V

13128-060

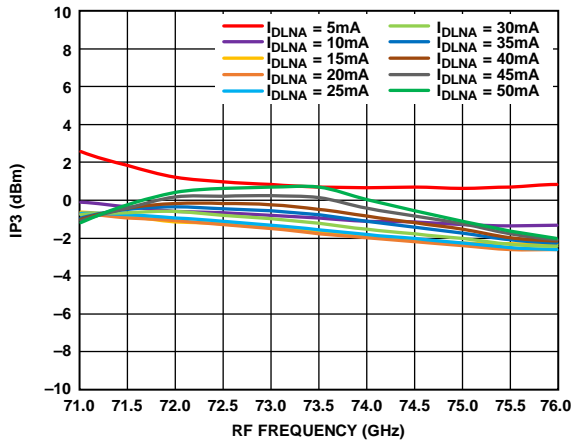

Figure 58. Input IP3 vs. RF Frequency at Various I_{DLNA} Values, $R_{FIN} = -20$ dBm, $LO = 2$ dBm, $IF = 500$ MHz, $V_{DLNA} = 4$ V

13128-058

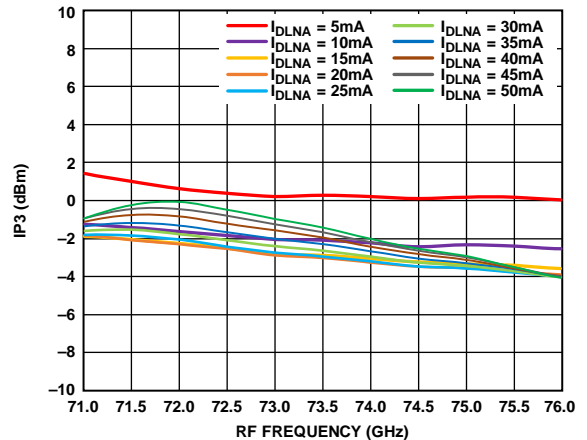

Figure 61. Input IP3 vs. RF Frequency at Various I_{DLNA} Values, $R_{FIN} = -20$ dBm, $LO = 2$ dBm, $IF = 500$ MHz, $V_{DLNA} = 3$ V

13128-061

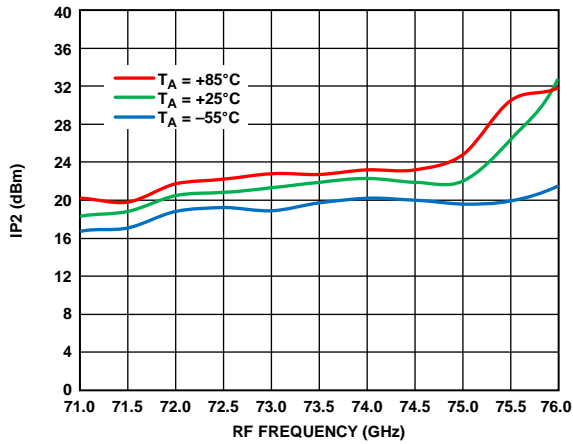

Figure 62. Input IP2 vs. RF Frequency at Various Temperatures, $R_{FIN} = -20$ dBm, LO = 2 dBm, IF = 500 MHz, $V_{DLNA} = 4$ V

13128-062

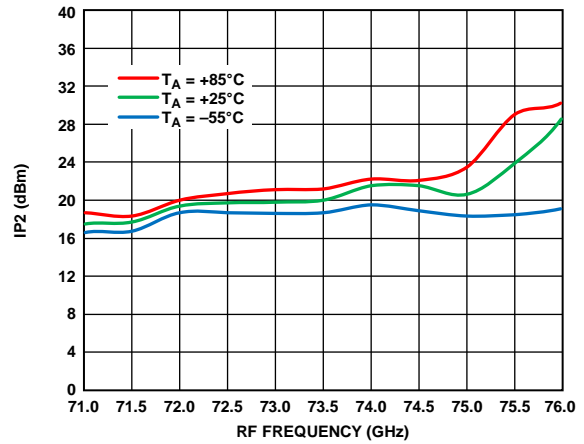

Figure 65. Input IP2 vs. RF Frequency at Various Temperatures, $R_{FIN} = -20$ dBm, LO = 2 dBm, IF = 500 MHz, $V_{DLNA} = 3$ V

13128-065

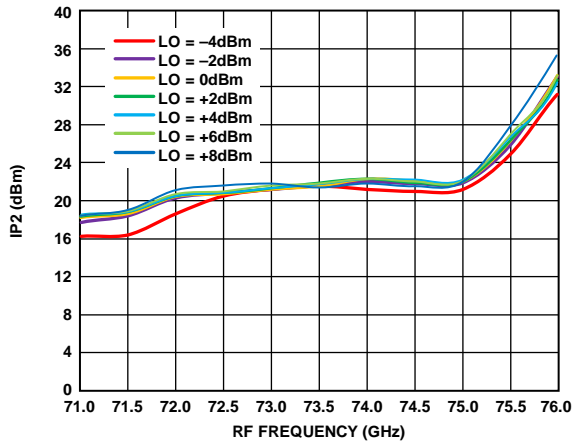

Figure 63. Input IP2 vs. RF Frequency at Various LO Powers, $R_{FIN} = -20$ dBm, IF = 500 MHz, $V_{DLNA} = 4$ V

13128-063

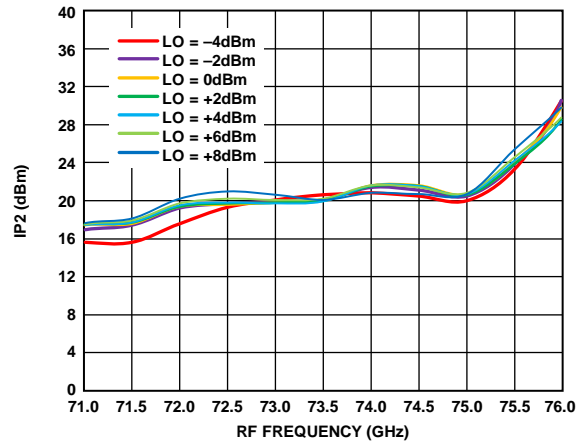

Figure 66. Input IP2 vs. RF Frequency at Various LO Powers, $R_{FIN} = -20$ dBm, IF = 500 MHz, $V_{DLNA} = 3$ V

13128-066

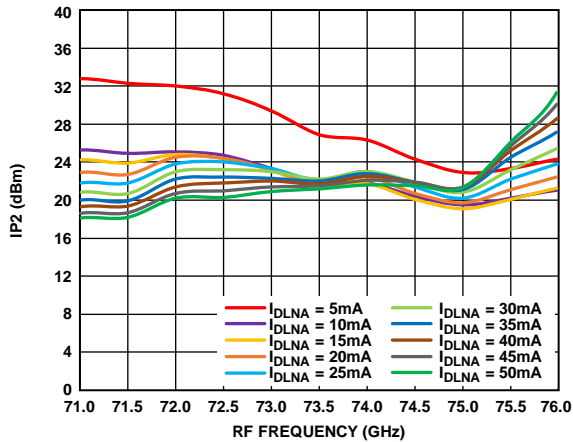

Figure 64. Input IP2 vs. RF Frequency at Various I_{DLNA} Values, $R_{FIN} = -20$ dBm, LO = 2 dBm, IF = 500 MHz, $V_{DLNA} = 4$ V

13128-064

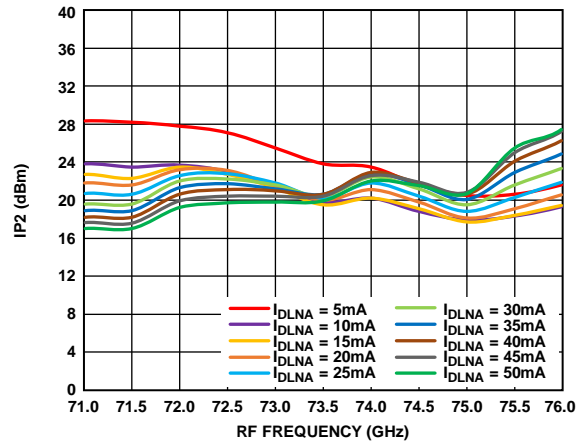

Figure 67. Input IP2 vs. RF Frequency at Various I_{DLNA} Values, $R_{FIN} = -20$ dBm, LO = 2 dBm, IF = 500 MHz, $V_{DLNA} = 3$ V

13128-067

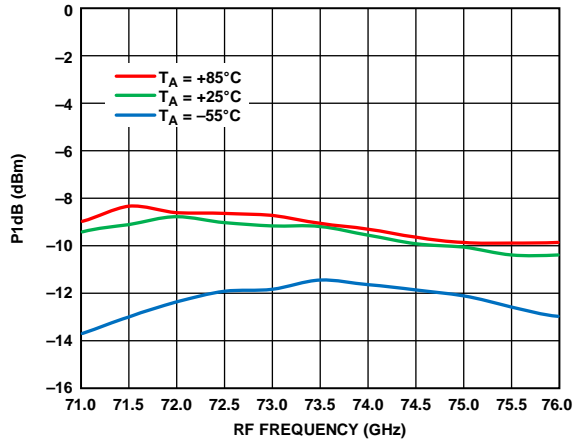

Figure 68. Input P1dB vs. RF Frequency at Various Temperatures, LO = 2 dBm, IF = 500 MHz, $V_{DLNA} = 4\text{ V}$

13128-068

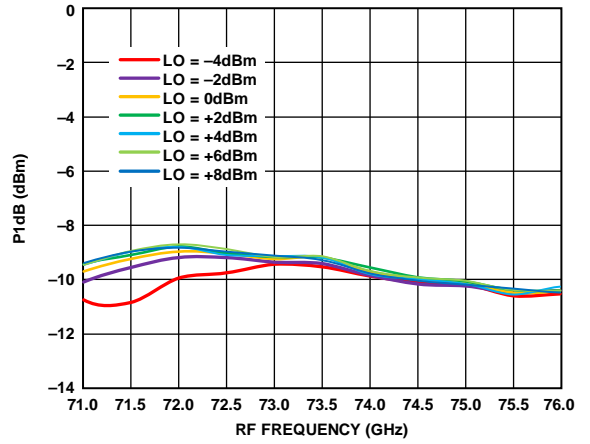

Figure 69. Input P1dB vs. RF Frequency at Various LO Powers, IF = 500 MHz, $V_{DLNA} = 4\text{ V}$

13128-071

LOWER SIDEBAND SELECTED, IF = 2000 MHz

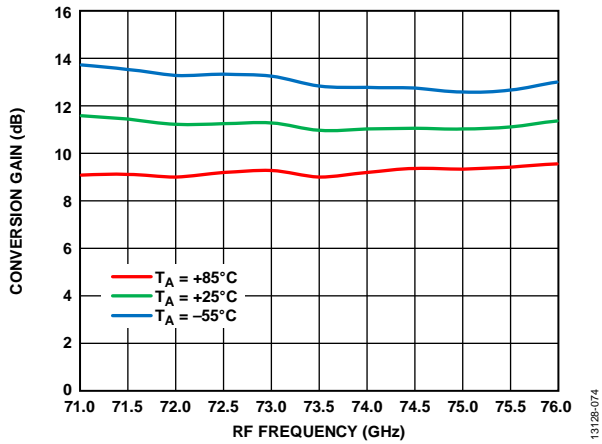

Figure 70. Conversion Gain vs. RF Frequency at Various Temperatures, $RFIN = -20$ dBm, $LO = 2$ dBm, $IF = 2000$ MHz, $V_{DLNA} = 4$ V

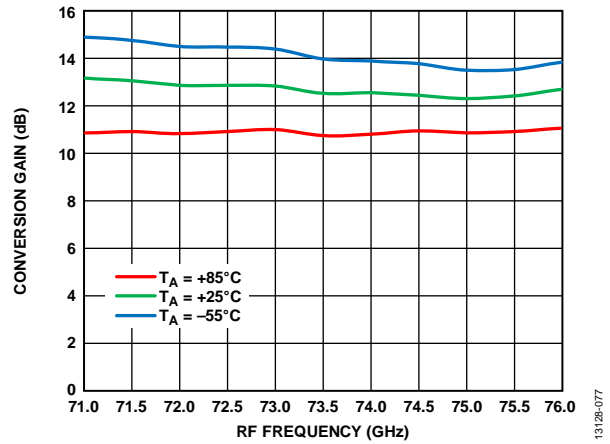

Figure 73. Conversion Gain vs. RF Frequency at Various Temperatures, $RFIN = -20$ dBm, $LO = 2$ dBm, $IF = 2000$ MHz, $V_{DLNA} = 3$ V

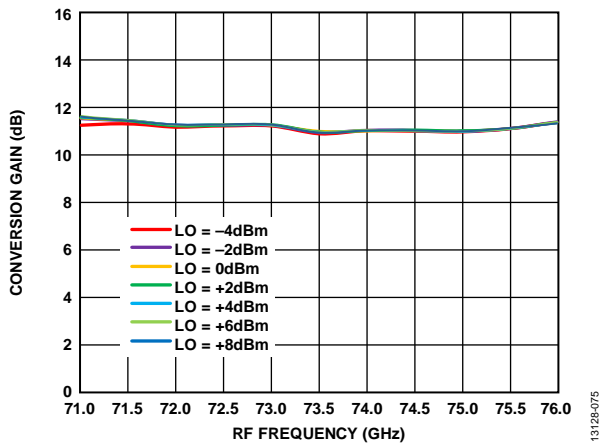

Figure 71. Conversion Gain vs. RF Frequency at Various LO Powers, $RFIN = -20$ dBm, $IF = 2000$ MHz, $V_{DLNA} = 4$ V

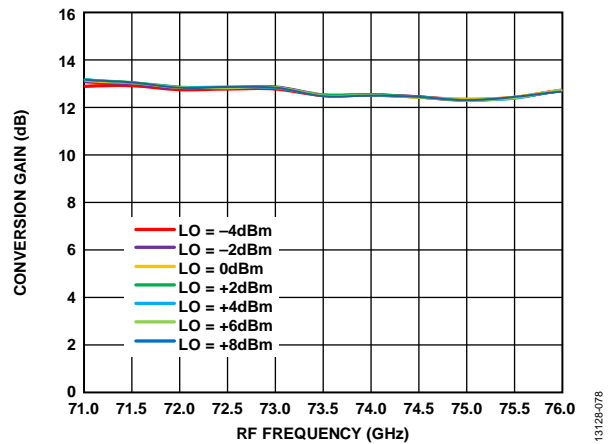

Figure 74. Conversion Gain vs. RF Frequency at Various LO Powers, $RFIN = -20$ dBm, $IF = 2000$ MHz, $V_{DLNA} = 3$ V

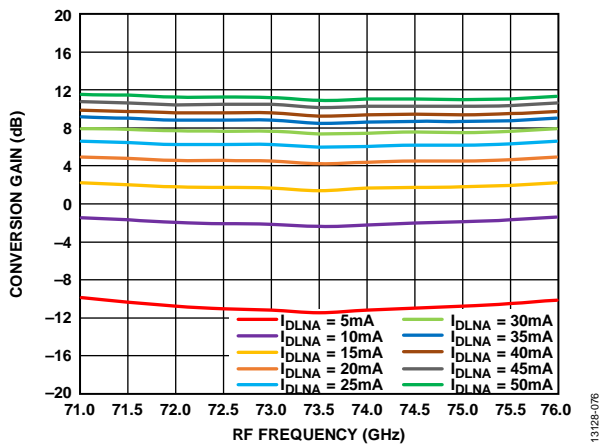

Figure 72. Conversion Gain vs. RF Frequency at Various I_{DLNA} Values, $RFIN = -20$ dBm, $IF = 2000$ MHz, $V_{DLNA} = 4$ V

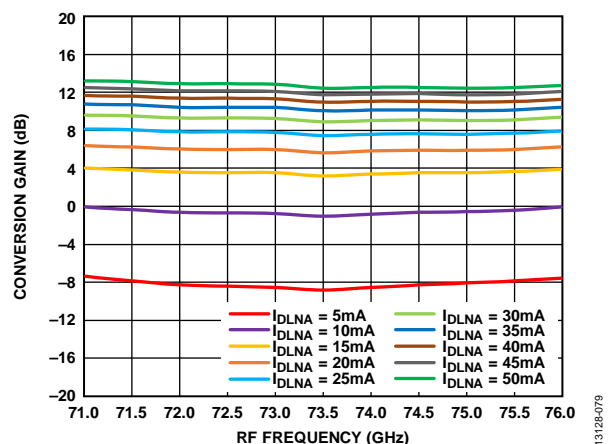

Figure 75. Conversion Gain vs. RF Frequency at Various I_{DLNA} Values, $RFIN = -20$ dBm, $IF = 2000$ MHz, $V_{DLNA} = 3$ V

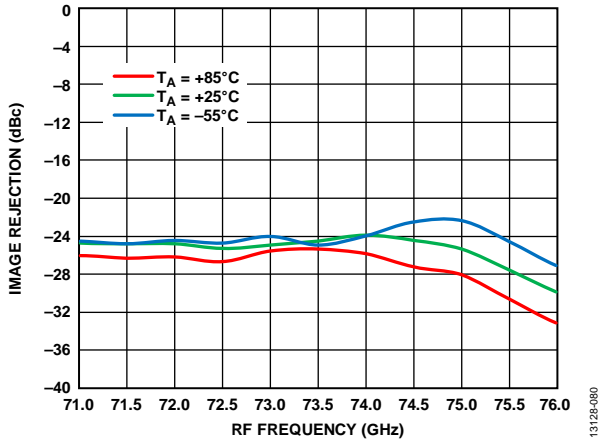

Figure 76. Image Rejection vs. RF Frequency at Various Temperatures, $R_{FIN} = -20$ dBm, $L_O = 2$ dBm, $I_F = 2000$ MHz, $V_{DLNA} = 4$ V

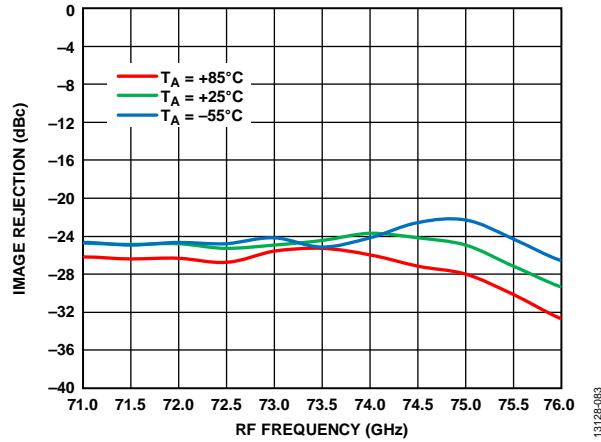

Figure 79. Image Rejection vs. RF Frequency at Various Temperatures, $R_{FIN} = -20$ dBm, $L_O = 2$ dBm, $I_F = 2000$ MHz, $V_{DLNA} = 3$ V

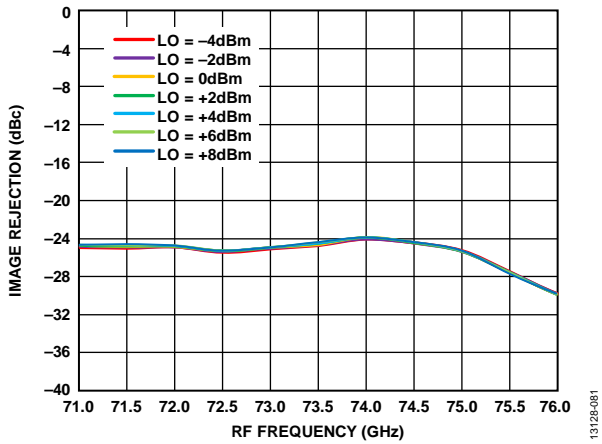

Figure 77. Image Rejection vs. RF Frequency at Various LO Powers, $R_{FIN} = -20$ dBm, $I_F = 2000$ MHz, $V_{DLNA} = 4$ V

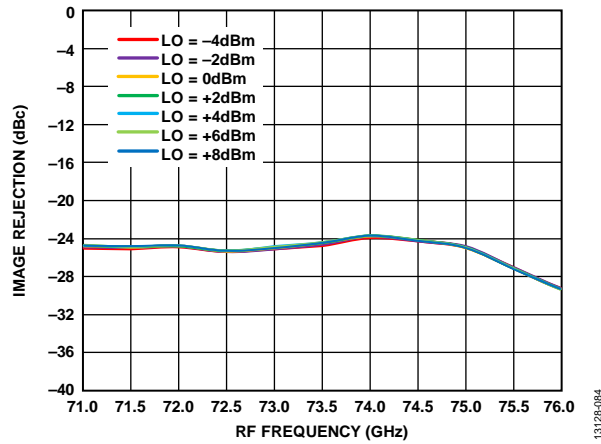

Figure 80. Image Rejection vs. RF Frequency at Various LO Powers, $R_{FIN} = -20$ dBm, $I_F = 2000$ MHz, $V_{DLNA} = 3$ V

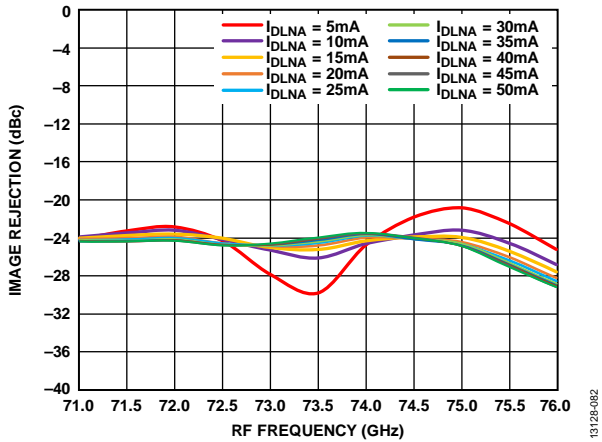

Figure 78. Image Rejection vs. RF Frequency at Various I_{DLNA} Values, $R_{FIN} = -20$ dBm, $L_O = 2$ dBm, $I_F = 2000$ MHz, $V_{DLNA} = 4$ V

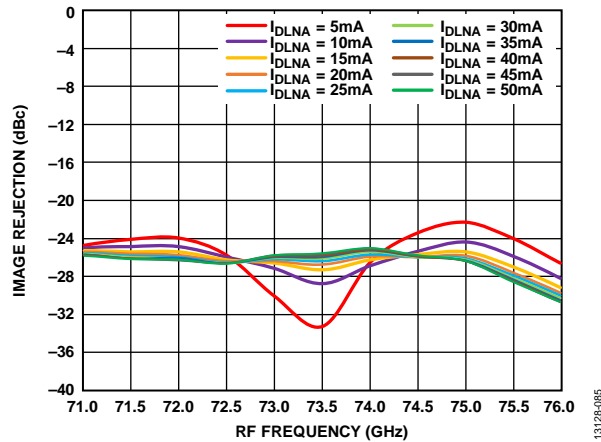

Figure 81. Image Rejection vs. RF Frequency at Various I_{DLNA} Values, $R_{FIN} = -20$ dBm, $L_O = 2$ dBm, $I_F = 2000$ MHz, $V_{DLNA} = 3$ V

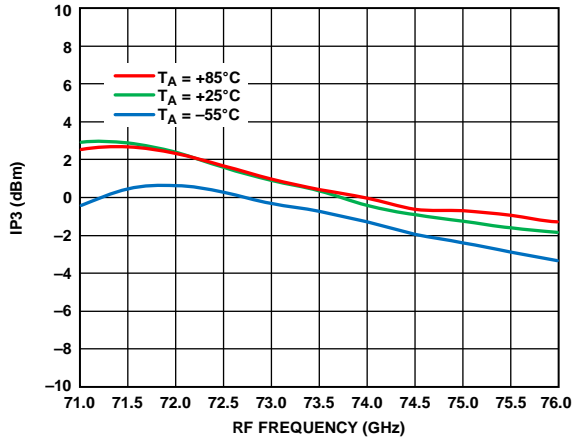

Figure 82. Input IP3 vs. RF Frequency at Various Temperatures, $R_{FIN} = -20$ dBm, $LO = 2$ dBm, $IF = 2000$ MHz, $V_{DLNA} = 4$ V

13128-086

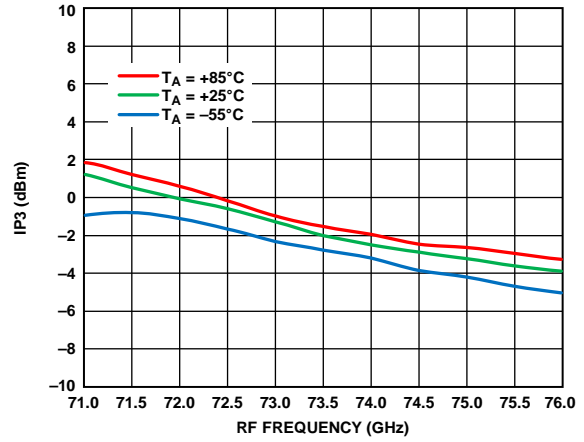

Figure 85. Input IP3 vs. RF Frequency at Various Temperatures, $R_{FIN} = -20$ dBm, $LO = 2$ dBm, $IF = 2000$ MHz, $V_{DLNA} = 3$ V

13128-088

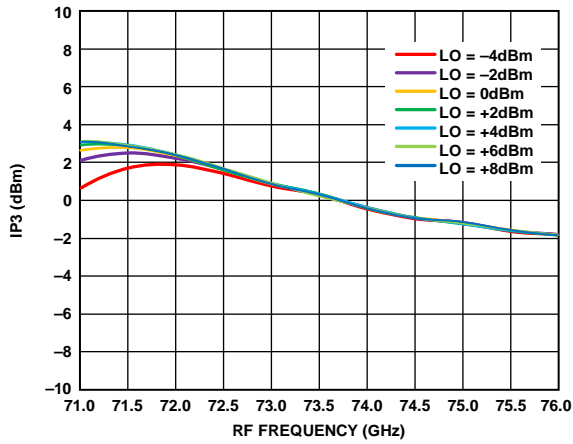

Figure 83. Input IP3 vs. RF Frequency at Various LO Powers, $R_{FIN} = -20$ dBm, $IF = 2000$ MHz, $V_{DLNA} = 4$ V

13128-087

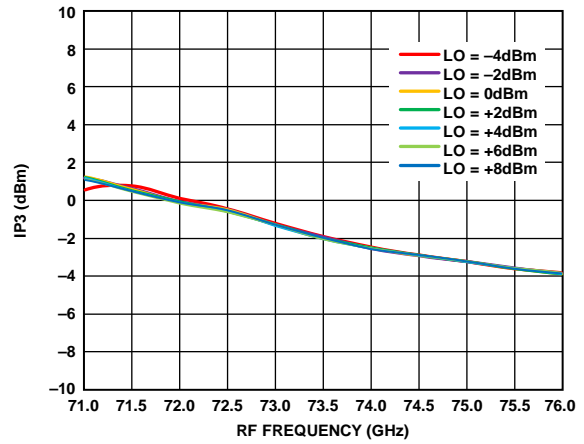

Figure 86. Input IP3 vs. RF Frequency at Various LO Powers, $R_{FIN} = -20$ dBm, $IF = 2000$ MHz, $V_{DLNA} = 3$ V

13128-090

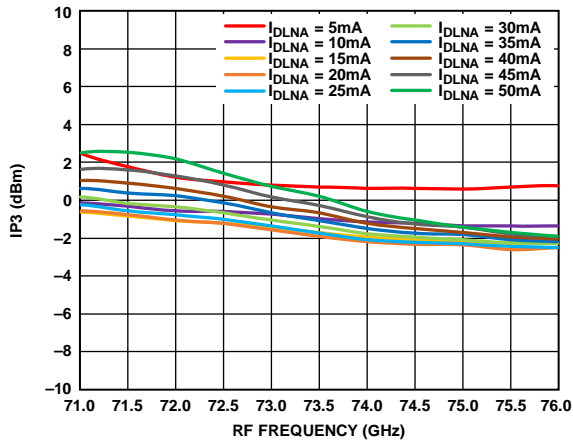

Figure 84. Input IP3 vs. RF Frequency at Various I_{DLNA} Values, $R_{FIN} = -20$ dBm, $LO = 2$ dBm, $IF = 2000$ MHz, $V_{DLNA} = 4$ V

13128-088

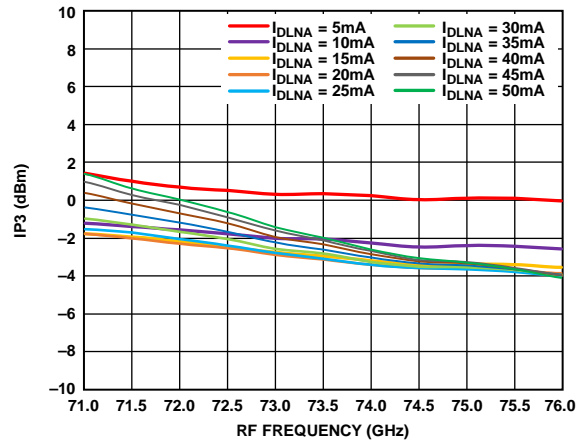

Figure 87. Input IP3 vs. RF Frequency at Various I_{DLNA} Values, $R_{FIN} = -20$ dBm, $LO = 2$ dBm, $IF = 2000$ MHz, $V_{DLNA} = 3$ V

13128-091

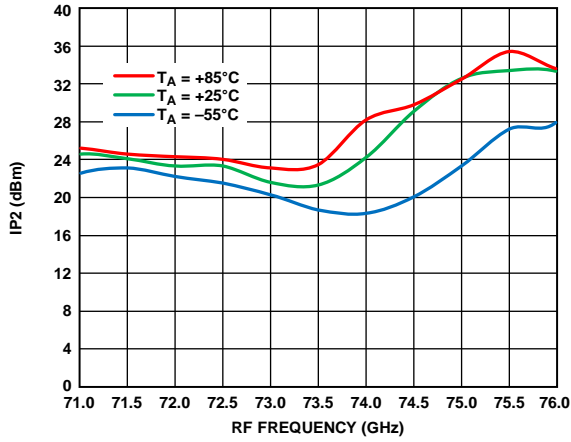

Figure 88. Input IP2 vs. RF Frequency at Various Temperatures, $R_{FIN} = -20$ dBm, $LO = 2$ dBm, $IF = 2000$ MHz, $V_{DLNA} = 4$ V

13128-092

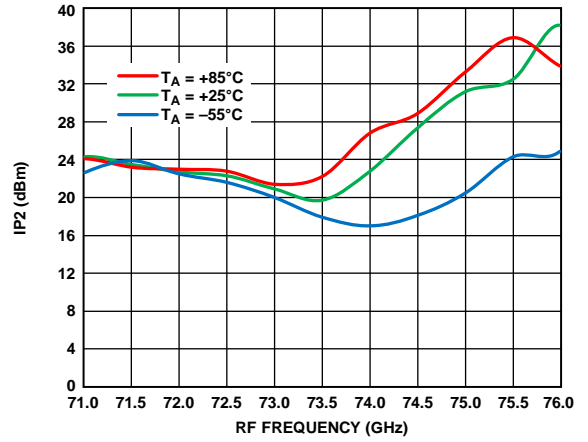

Figure 91. Input IP2 vs. RF Frequency at Various Temperatures, $R_{FIN} = -20$ dBm, $LO = 2$ dBm, $IF = 2000$ MHz, $V_{DLNA} = 3$ V

13128-095

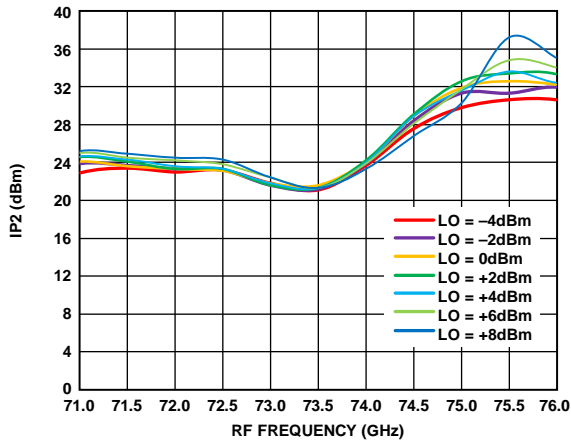

Figure 89. Input IP2 vs. RF Frequency at Various LO Powers, $R_{FIN} = -20$ dBm, $IF = 2000$ MHz, $V_{DLNA} = 4$ V

13128-093

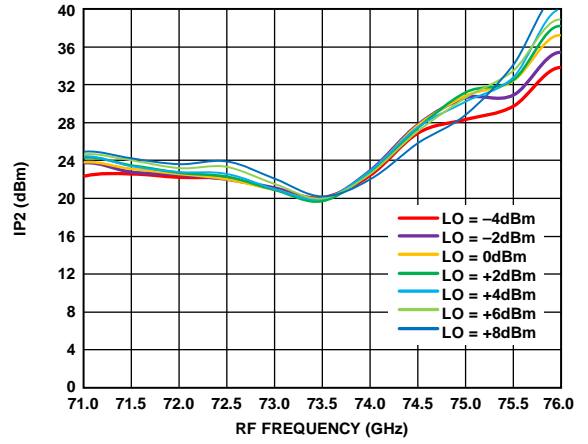

Figure 92. Input IP2 vs. RF Frequency at Various LO Powers, $R_{FIN} = -20$ dBm, $IF = 2000$ MHz, $V_{DLNA} = 3$ V

13128-096

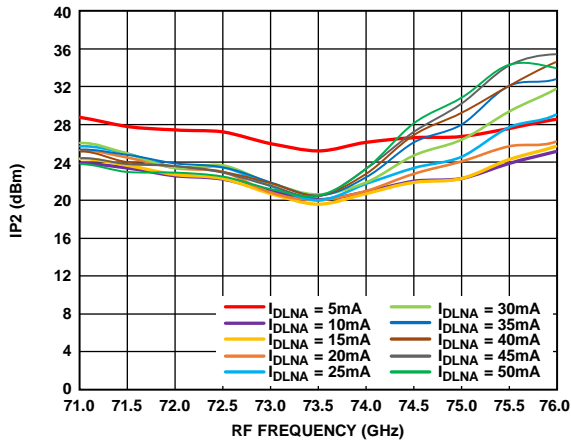

Figure 90. Input IP2 vs. RF Frequency at Various I_{DLNA} Values, $R_{FIN} = -20$ dBm, $LO = 2$ dBm, $IF = 2000$ MHz, $V_{DLNA} = 4$ V

13128-094

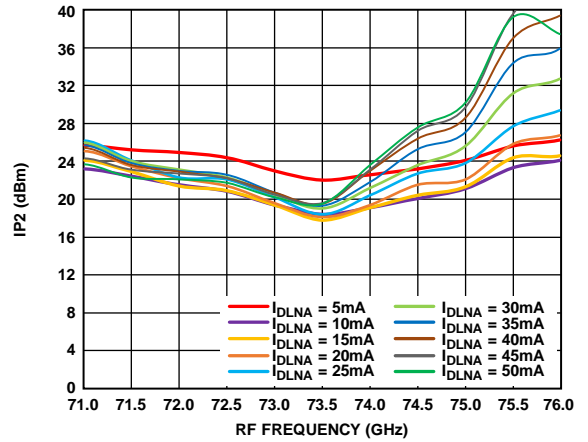

Figure 93. Input IP2 vs. RF Frequency at Various I_{DLNA} Values, $R_{FIN} = -20$ dBm, $LO = 2$ dBm, $IF = 2000$ MHz, $V_{DLNA} = 3$ V

13128-097

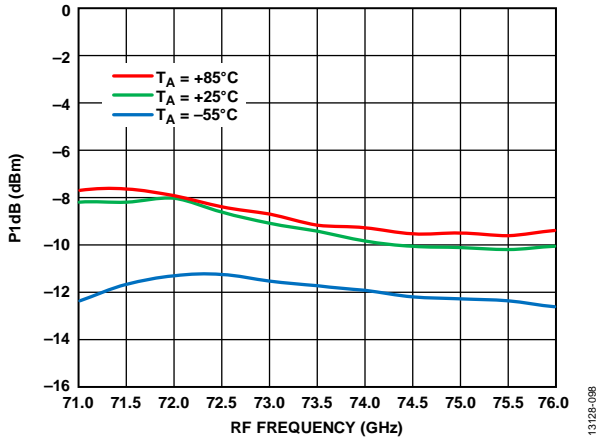

Figure 94. Input P1dB vs. RF Frequency at Various Temperatures, LO = 2 dBm, IF = 2000 MHz, V_{DLNA} = 4 V

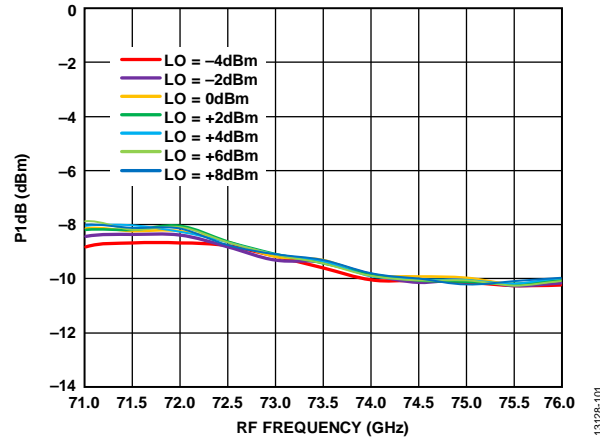

Figure 95. Input P1dB vs. RF Frequency at Various LO Powers, IF = 2000 MHz, V_{DLNA} = 4 V

1312E-098

1312E-101

NOISE FIGURE PERFORMANCE, LOWER SIDEBAND SELECTED

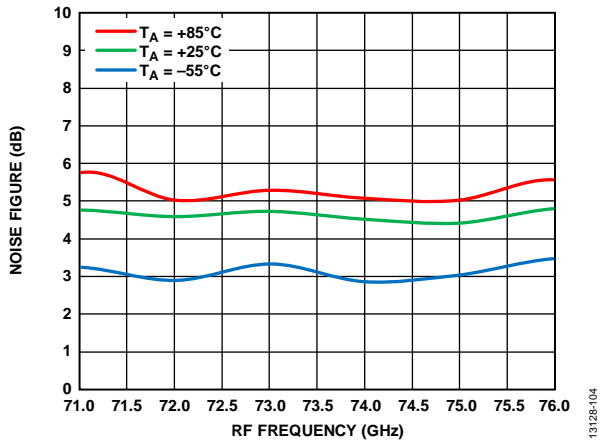

Figure 96. Noise Figure vs. RF Frequency at Various Temperatures, LO = 2 dBm, IF = 500 MHz, $V_{DLNA} = 3 V$

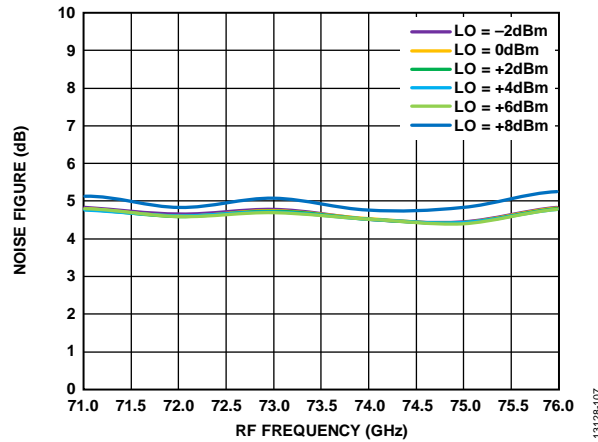

Figure 99. Noise Figure vs. RF Frequency at Various LO Powers, IF = 500 MHz, $V_{DLNA} = 3 V$

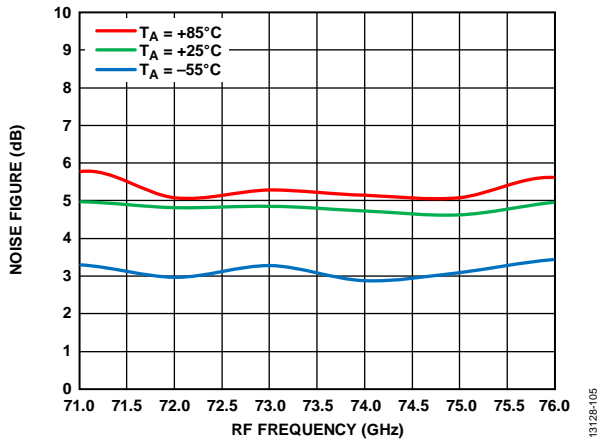

Figure 97. Noise Figure vs. RF Frequency at Various Temperatures, LO = 2 dBm, IF = 1000 MHz, $V_{DLNA} = 3 V$

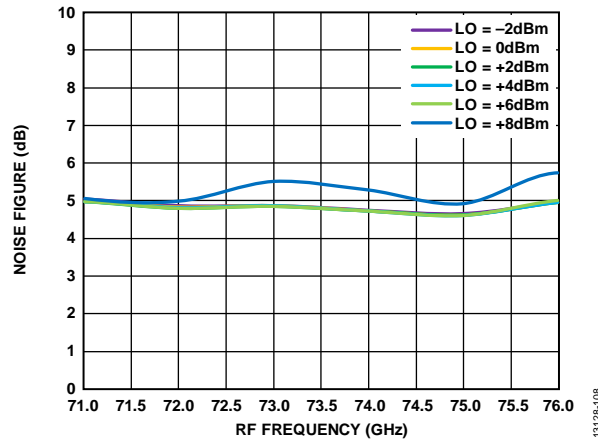

Figure 100. Noise Figure vs. RF Frequency at Various LO Powers, IF = 1000 MHz, $V_{DLNA} = 3 V$

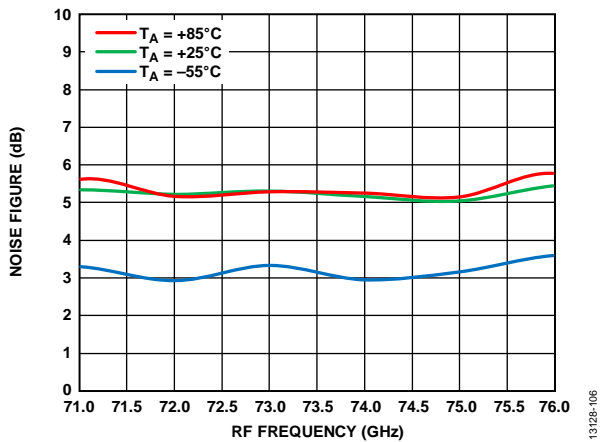

Figure 98. Noise Figure vs. RF Frequency at Various Temperatures, LO = 2 dBm, IF = 2000 MHz, $V_{DLNA} = 3 V$

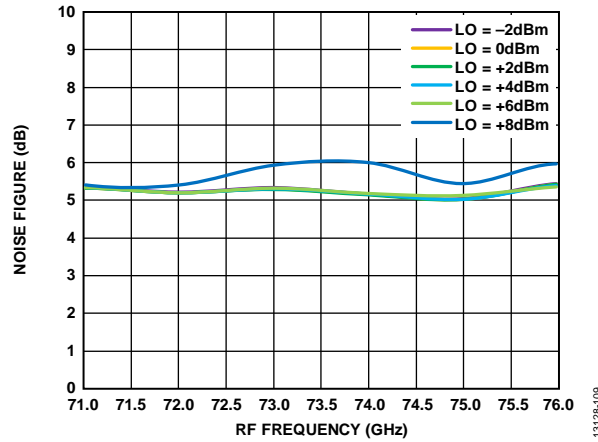

Figure 101. Noise Figure vs. RF Frequency at Various LO Powers, IF = 2000 MHz, $V_{DLNA} = 3 V$

AMPLITUDE BALANCE PERFORMANCE, LOWER SIDEBAND SELECTED

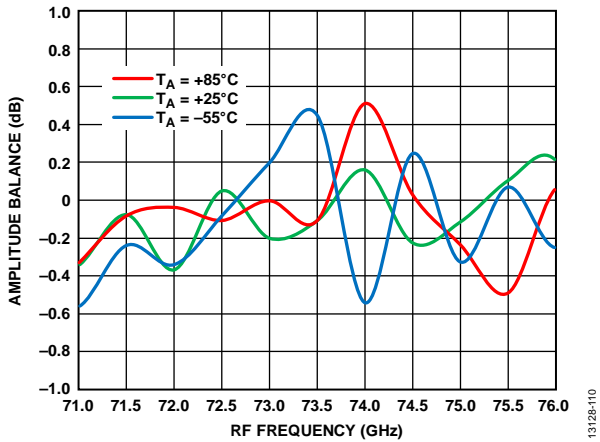

Figure 102. Amplitude Balance vs. RF Frequency at Various Temperatures, RFIN = -20 dBm, LO = 2 dBm, IF = 500 MHz, VDLNA = 4 V

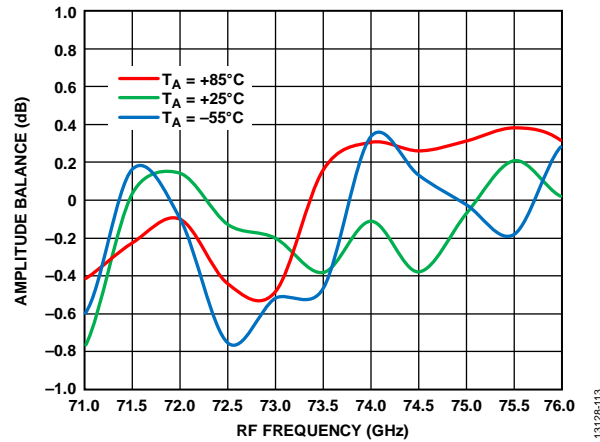

Figure 105. Amplitude Balance vs. RF Frequency at Various Temperatures, RFIN = -20 dBm, LO = 2 dBm, IF = 500 MHz, VDLNA = 3 V

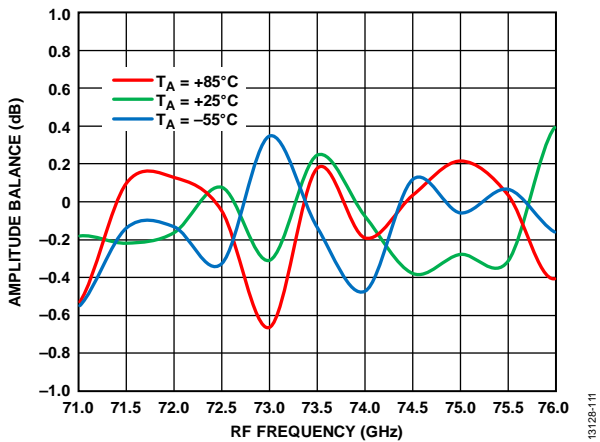

Figure 103. Amplitude Balance vs. RF Frequency at Various Temperatures, RFIN = -20 dBm, LO = 2 dBm, IF = 1000 MHz, VDLNA = 4 V

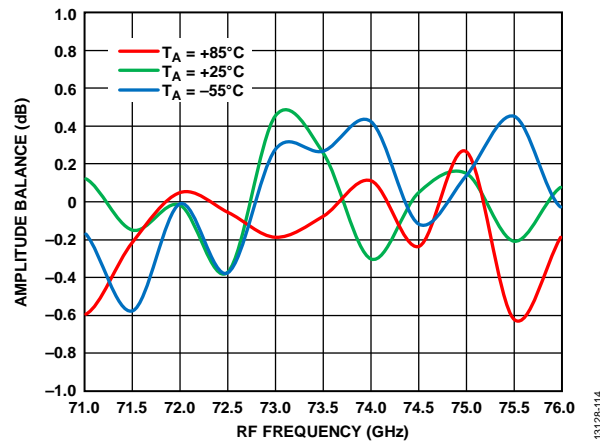

Figure 106. Amplitude Balance vs. RF Frequency at Various Temperatures, RFIN = -20 dBm, LO = 2 dBm, IF = 1000 MHz, VDLNA = 3 V

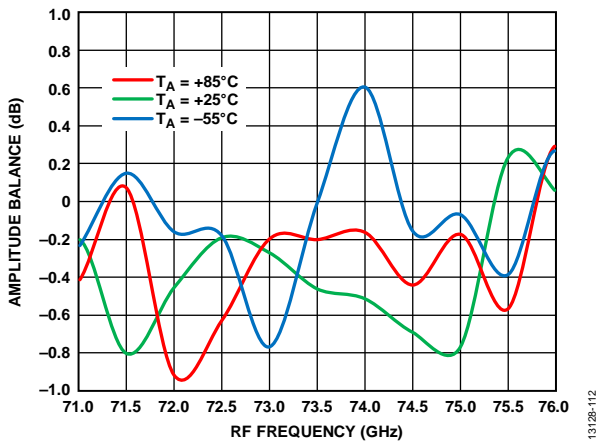

Figure 104. Amplitude Balance vs. RF Frequency at Various Temperatures, RFIN = -20 dBm, LO = 2 dBm, IF = 2000 MHz, VDLNA = 4 V

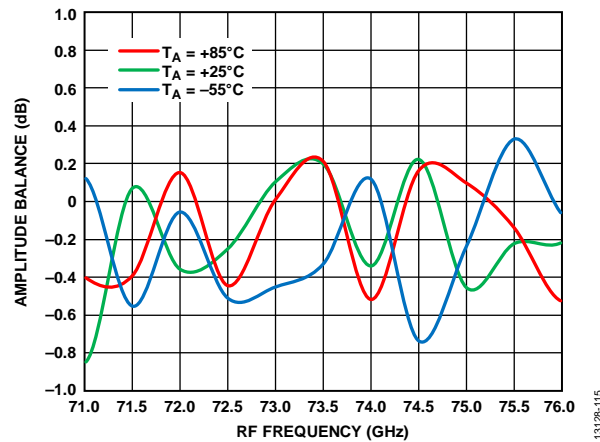

Figure 107. Amplitude Balance vs. RF Frequency at Various Temperatures, RFIN = -20 dBm, LO = 2 dBm, IF = 2000 MHz, VDLNA = 3 V

PHASE BALANCE PERFORMANCE, LOWER SIDEBAND SELECTED

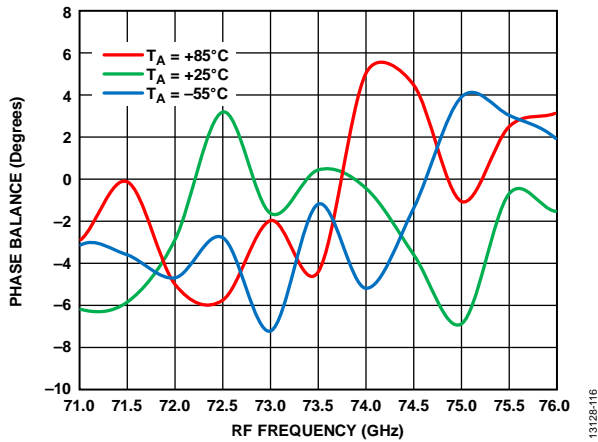

Figure 108. Phase Balance vs. RF Frequency at Various Temperatures, RFIN = -20 dBm, LO = 2 dBm, IF = 500 MHz, VDLNA = 4 V

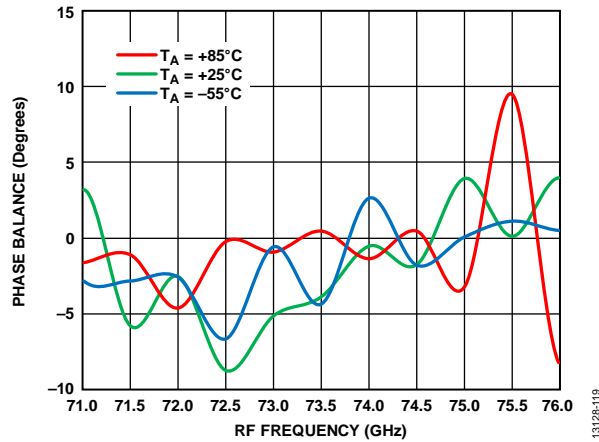

Figure 111. Phase Balance vs. RF Frequency at Various Temperatures, RFIN = -20 dBm, LO = 2 dBm, IF = 500 MHz, VDLNA = 3 V

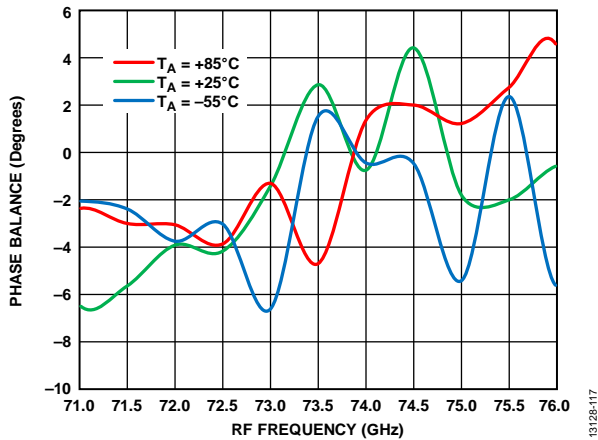

Figure 109. Phase Balance vs. RF Frequency at Various Temperatures, RFIN = -20 dBm, LO = 2 dBm, IF = 1000 MHz, VDLNA = 4 V

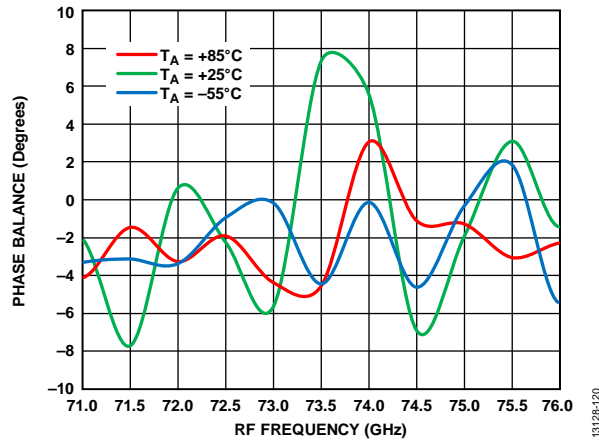

Figure 112. Phase Balance vs. RF Frequency at Various Temperatures, RFIN = -20 dBm, LO = 2 dBm, IF = 1000 MHz, VDLNA = 3 V

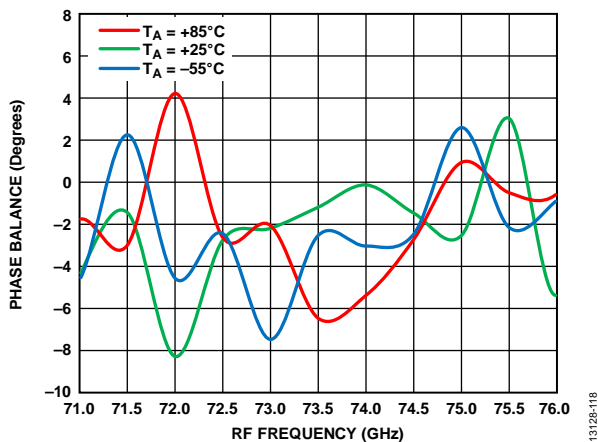

Figure 110. Phase Balance vs. RF Frequency at Various Temperatures, RFIN = -20 dBm, LO = 2 dBm, IF = 2000 MHz, VDLNA = 4 V

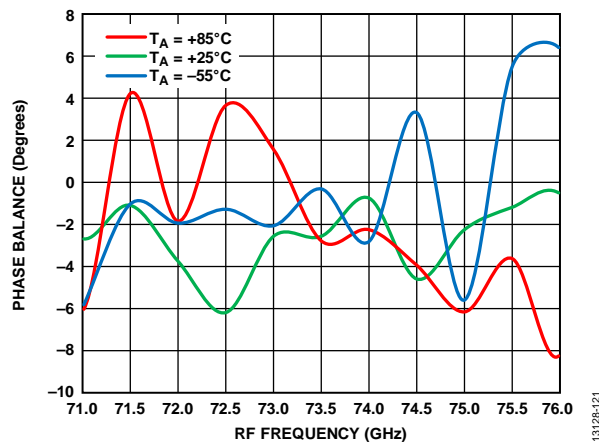

Figure 113. Phase Balance vs. RF Frequency at Various Temperatures, RFIN = -20 dBm, LO = 2 dBm, IF = 2000 MHz, VDLNA = 3 V

UPPER SIDEBAND SELECTED, IF = 500 MHz

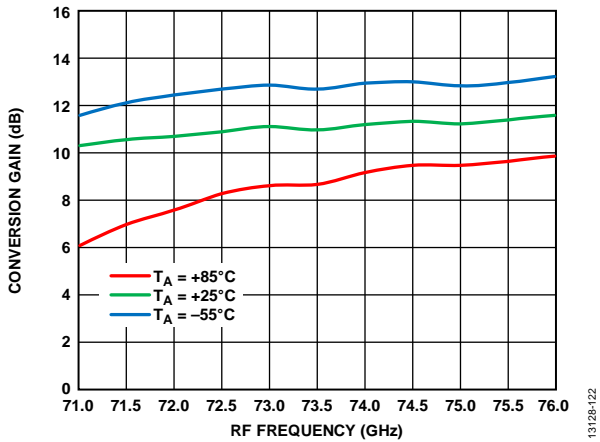

Figure 114. Conversion Gain vs. RF Frequency at Various Temperatures, $R_{FIN} = -20$ dBm, $LO = 2$ dBm, $IF = 500$ MHz, $V_{DLNA} = 4$ V

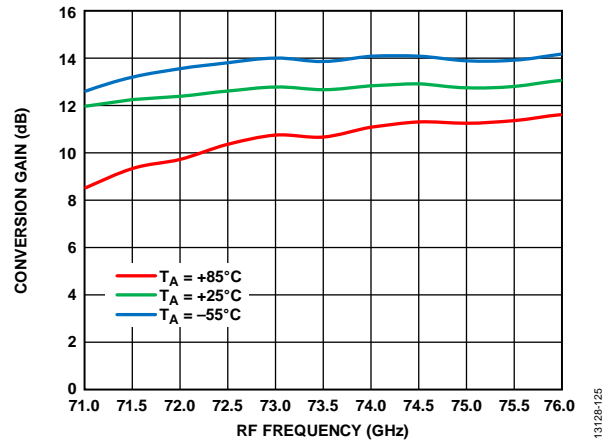

Figure 117. Conversion Gain vs. RF Frequency at Various Temperatures, $R_{FIN} = -20$ dBm, $LO = 2$ dBm, $IF = 500$ MHz, $V_{DLNA} = 3$ V

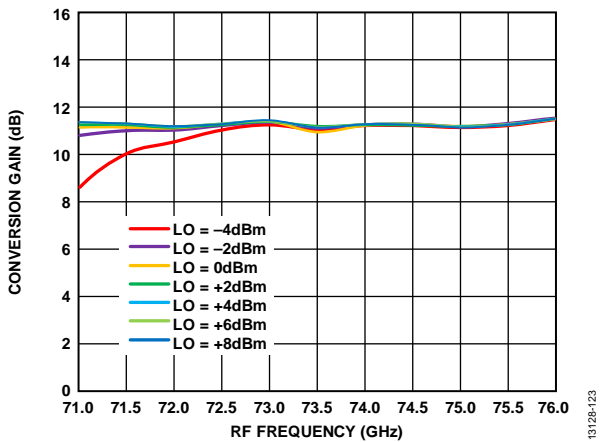

Figure 115. Conversion Gain vs. RF Frequency at Various LO Powers, $R_{FIN} = -20$ dBm, $IF = 500$ MHz, $V_{DLNA} = 4$ V

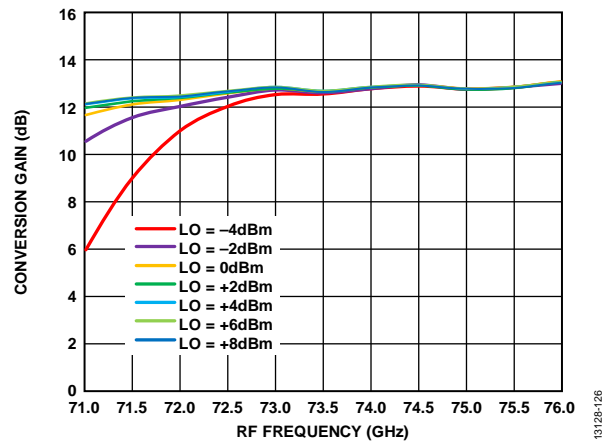

Figure 118. Conversion Gain vs. RF Frequency at Various LO Powers, $R_{FIN} = -20$ dBm, $IF = 500$ MHz, $V_{DLNA} = 3$ V

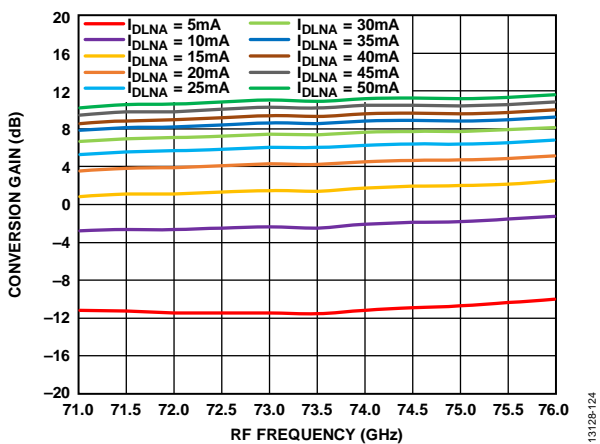

Figure 116. Conversion Gain vs. RF Frequency at Various I_{DLNA} Values, $R_{FIN} = -20$ dBm, $IF = 500$ MHz, $V_{DLNA} = 4$ V

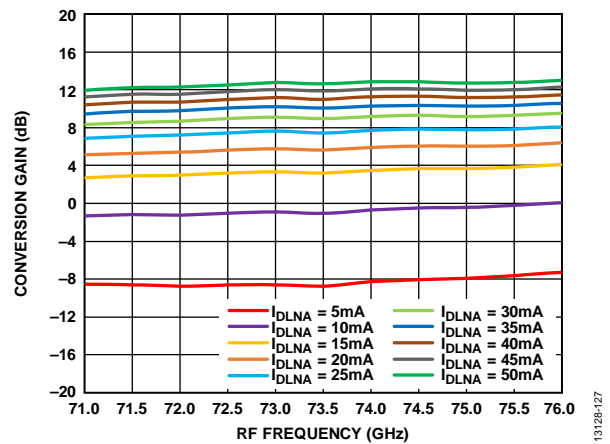

Figure 119. Conversion Gain vs. RF Frequency at Various I_{DLNA} Values, $R_{FIN} = -20$ dBm, $IF = 500$ MHz, $V_{DLNA} = 3$ V

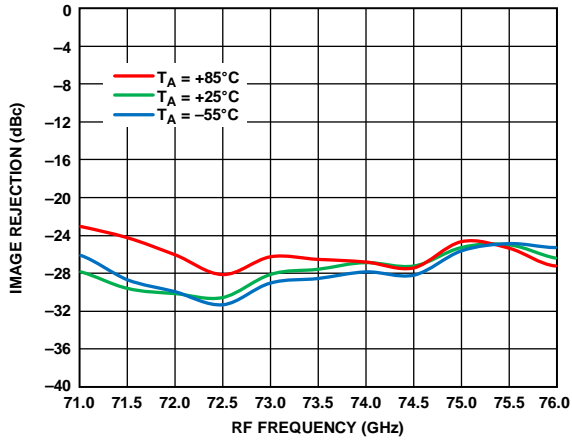

Figure 120. Image Rejection vs. RF Frequency at Various Temperatures, $RFIN = -20\text{ dBm}$, $LO = 2\text{ dBm}$, $IF = 500\text{ MHz}$, $V_{DLNA} = 4\text{ V}$

13128-128

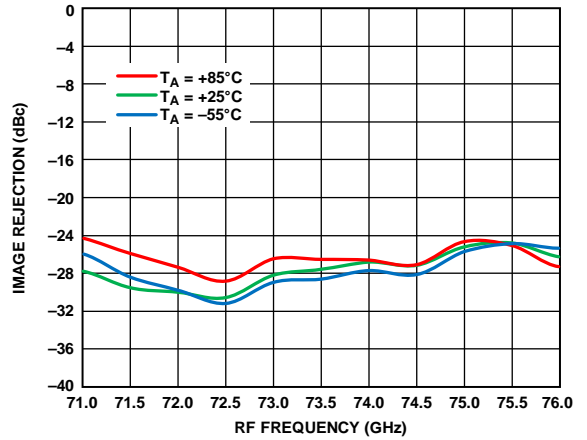

Figure 123. Image Rejection vs. RF Frequency at Various Temperatures, $RFIN = -20\text{ dBm}$, $LO = 2\text{ dBm}$, $IF = 500\text{ MHz}$, $V_{DLNA} = 3\text{ V}$

13128-131

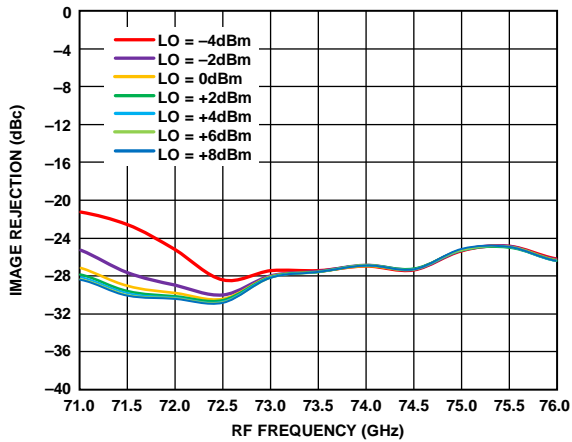

Figure 121. Image Rejection vs. RF Frequency at Various LO Powers, $RFIN = -20\text{ dBm}$, $IF = 500\text{ MHz}$, $V_{DLNA} = 4\text{ V}$

13128-129

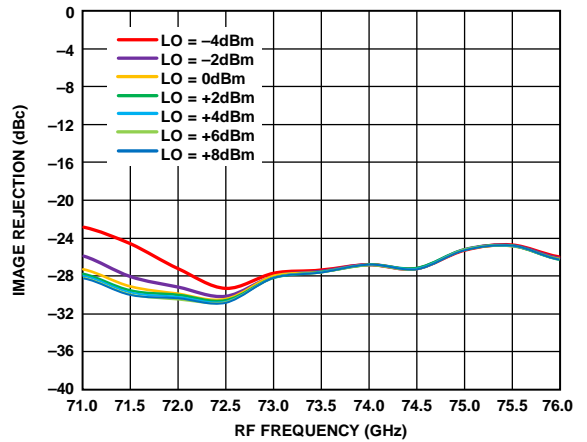

Figure 124. Image Rejection vs. RF Frequency at Various LO Powers, $RFIN = -20\text{ dBm}$, $IF = 500\text{ MHz}$, $V_{DLNA} = 3\text{ V}$

13128-132

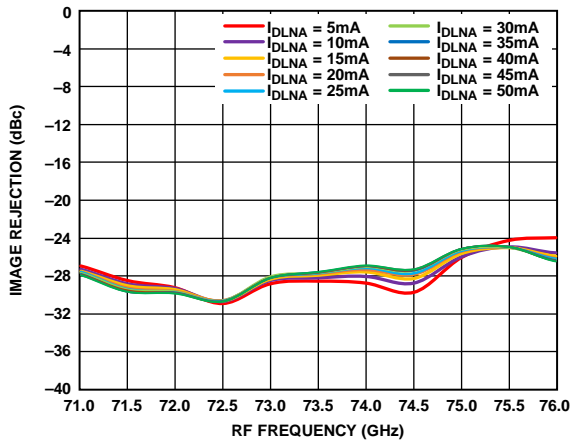

Figure 122. Image Rejection vs. RF Frequency at Various I_{DLNA} Values, $RFIN = -20\text{ dBm}$, $LO = 2\text{ dBm}$, $IF = 500\text{ MHz}$, $V_{DLNA} = 4\text{ V}$

13128-130

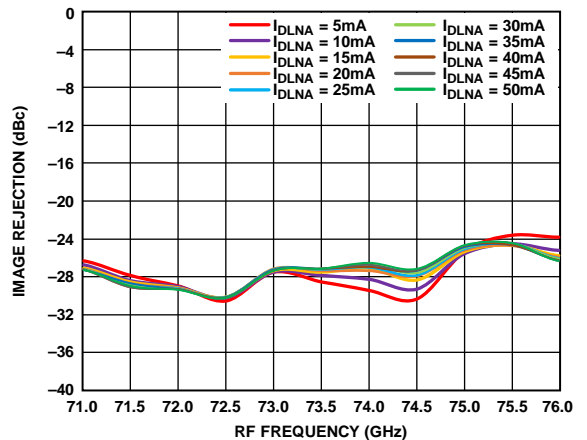
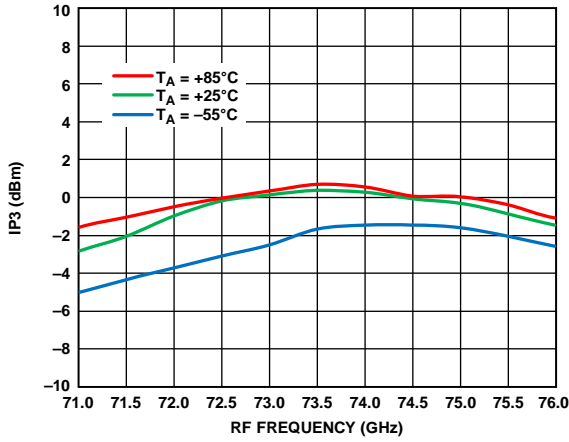

Figure 125. Image Rejection vs. RF Frequency at Various I_{DLNA} Values, $RFIN = -20\text{ dBm}$, $LO = 2\text{ dBm}$, $IF = 500\text{ MHz}$, $V_{DLNA} = 3\text{ V}$

13128-133



13128-134

Figure 126. Input IP3 vs. RF Frequency at Various Temperatures, $R_{FIN} = -20$ dBm, LO = 2 dBm, IF = 500 MHz, $V_{DLNA} = 4$ V

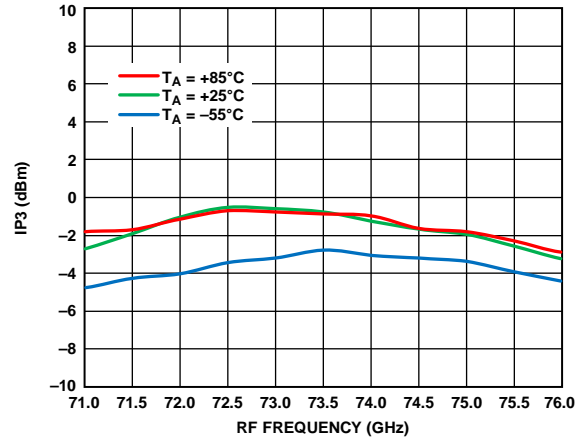

13128-137

Figure 129. Input IP3 vs. RF Frequency at Various Temperatures, $R_{FIN} = -20$ dBm, LO = 2 dBm, IF = 500 MHz, $V_{DLNA} = 3$ V

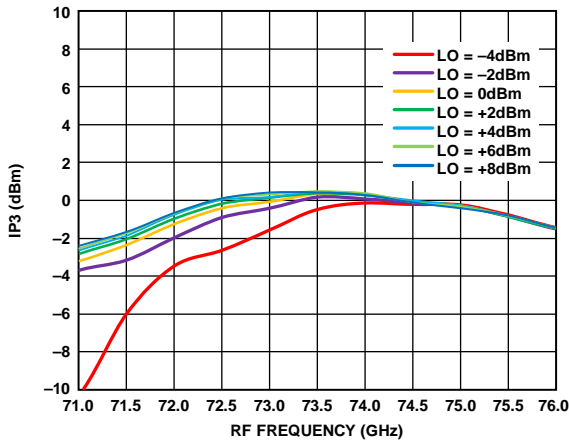

13128-135

Figure 127. Input IP3 vs. RF Frequency at Various LO Powers, $R_{FIN} = -20$ dBm, IF = 500 MHz, $V_{DLNA} = 4$ V

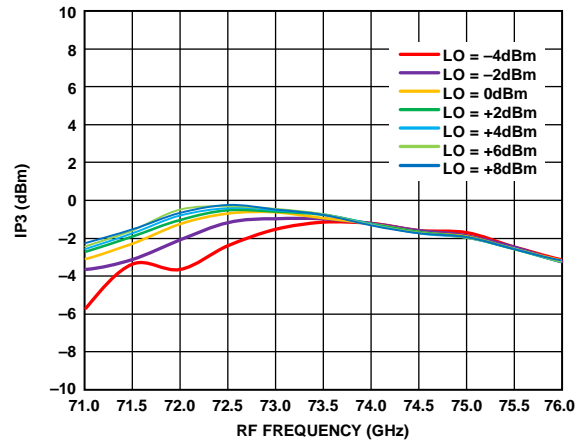

13128-138

Figure 130. Input IP3 vs. RF Frequency at Various LO Powers, $R_{FIN} = -20$ dBm, IF = 500 MHz, $V_{DLNA} = 3$ V

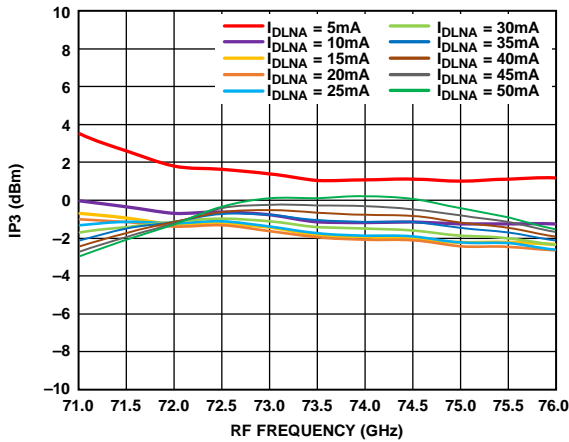

13128-136

Figure 128. Input IP3 vs. RF Frequency at Various I_{DLNA} Values, $R_{FIN} = -20$ dBm, LO = 2 dBm, IF = 500 MHz, $V_{DLNA} = 4$ V

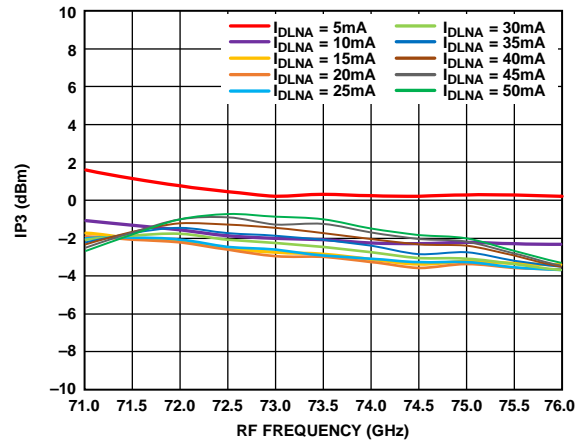

13128-139

Figure 131. Input IP3 vs. RF Frequency at Various I_{DLNA} Values, $R_{FIN} = -20$ dBm, LO = 2 dBm, IF = 500 MHz, $V_{DLNA} = 3$ V

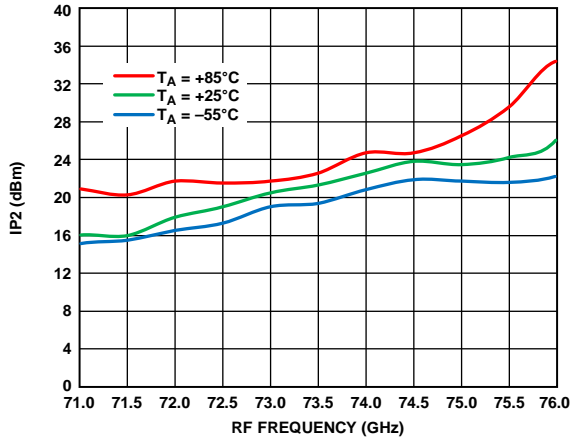

Figure 132. Input IP2 vs. RF Frequency at Various Temperatures, $R_{FIN} = -20$ dBm, $LO = 2$ dBm, $IF = 500$ MHz, $V_{DLNA} = 4$ V

13128-140

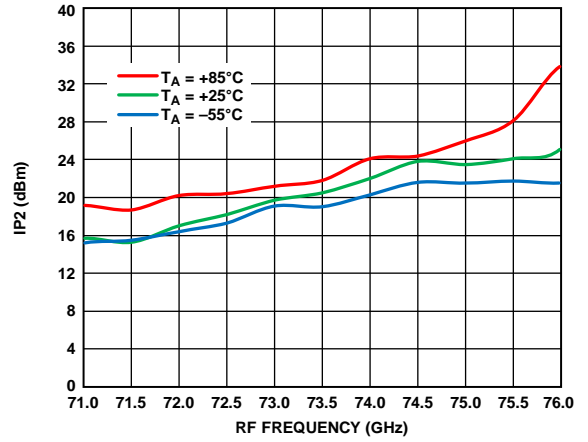

Figure 135. Input IP2 vs. RF Frequency at Various Temperatures, $R_{FIN} = -20$ dBm, $LO = 2$ dBm, $IF = 500$ MHz, $V_{DLNA} = 3$ V

13128-143

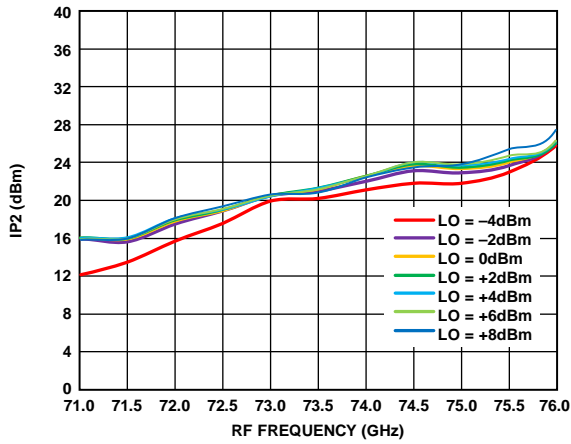

Figure 133. Input IP2 vs. RF Frequency at Various LO Powers, $R_{FIN} = -20$ dBm, $IF = 500$ MHz, $V_{DLNA} = 4$ V

13128-141

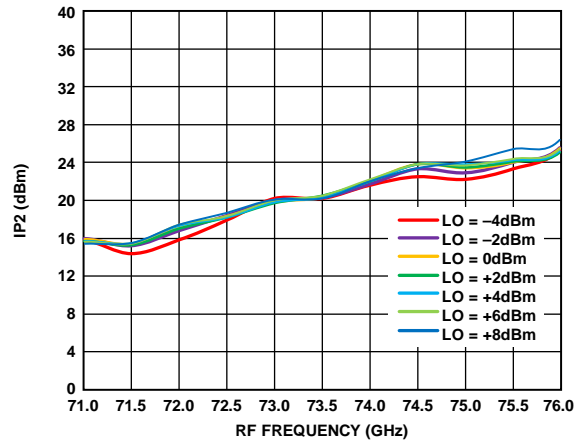

Figure 136. Input IP2 vs. RF Frequency at Various LO Powers, $R_{FIN} = -20$ dBm, $IF = 500$ MHz, $V_{DLNA} = 3$ V

13128-144

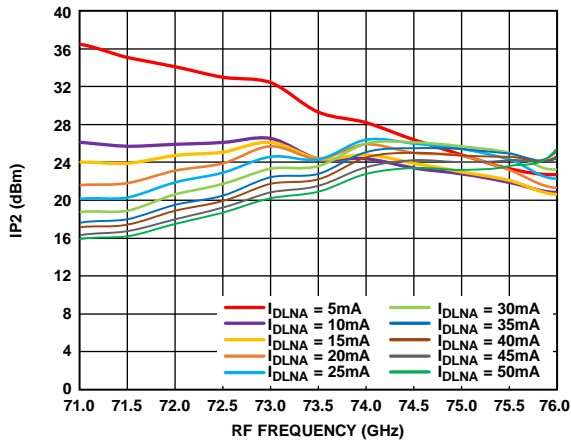

Figure 134. Input IP2 vs. RF Frequency at Various I_{DLNA} Values, $R_{FIN} = -20$ dBm, $LO = 2$ dBm, $IF = 500$ MHz, $V_{DLNA} = 4$ V

13128-142

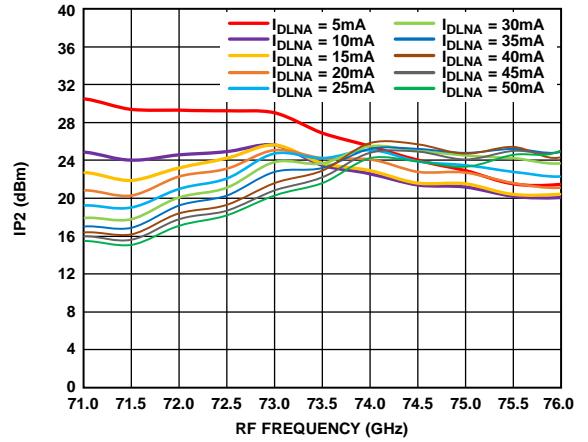

Figure 137. Input IP2 vs. RF Frequency at Various I_{DLNA} Values, $R_{FIN} = -20$ dBm, $LO = 2$ dBm, $IF = 500$ MHz, $V_{DLNA} = 3$ V

13128-145

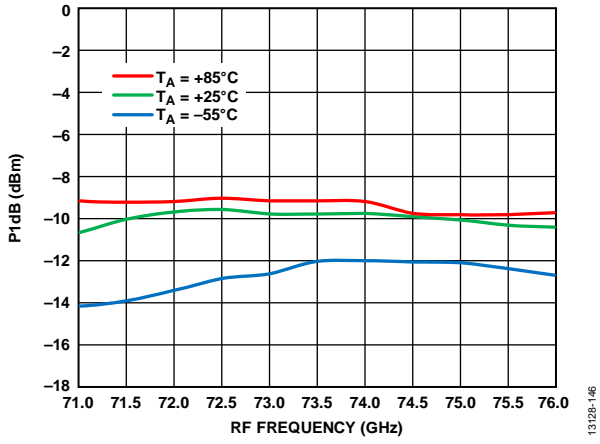

Figure 138. Input P1dB vs. RF Frequency at Various Temperatures, LO = 2 dBm, IF = 500 MHz, $V_{DLNA} = 4 V$

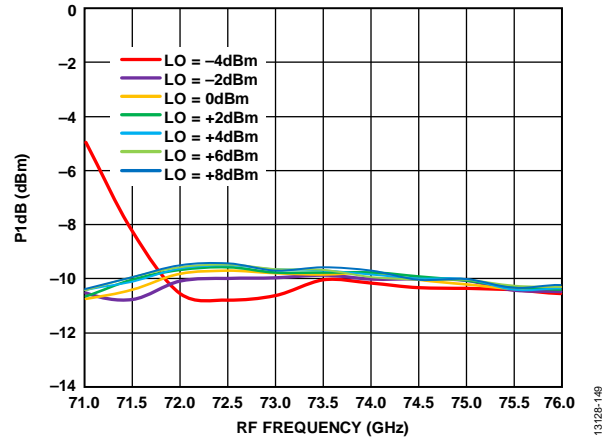

Figure 139. Input P1dB vs. RF Frequency at Various LO Powers, IF = 500 MHz, $V_{DLNA} = 4 V$

UPPER SIDEBAND SELECTED, IF = 1000 MHz

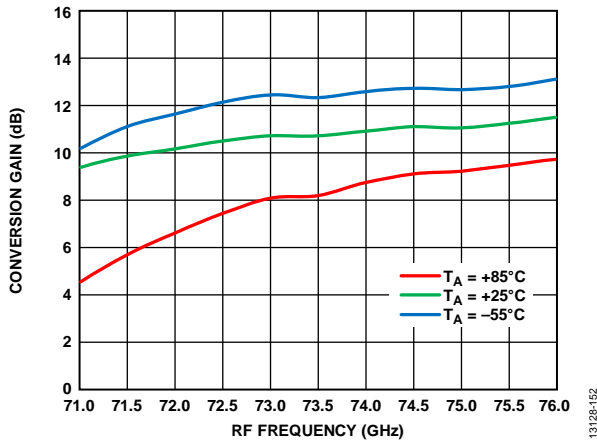

Figure 140. Conversion Gain vs. RF Frequency at Various Temperatures, $R_{FIN} = -20$ dBm, $L_O = 2$ dBm, $I_F = 1000$ MHz, $V_{DLNA} = 4$ V

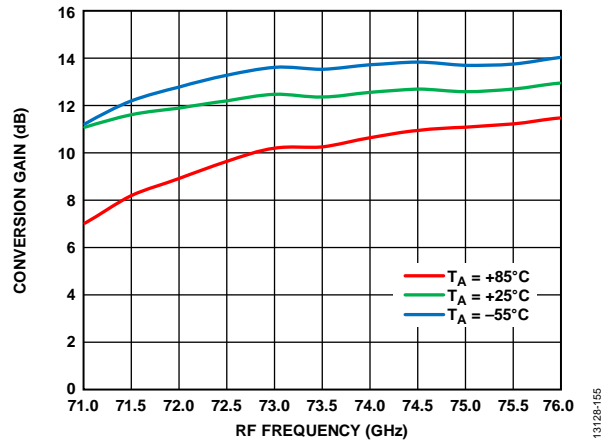

Figure 143. Conversion Gain vs. RF Frequency at Various Temperatures, $R_{FIN} = -20$ dBm, $L_O = 2$ dBm, $I_F = 1000$ MHz, $V_{DLNA} = 3$ V

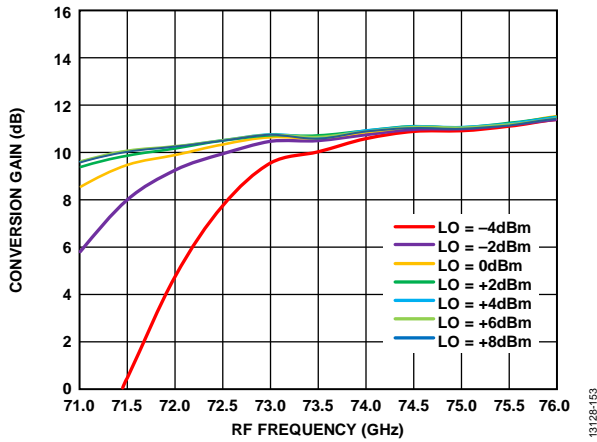

Figure 141. Conversion Gain vs. RF Frequency at Various LO Powers, $R_{FIN} = -20$ dBm, $I_F = 1000$ MHz, $V_{DLNA} = 4$ V

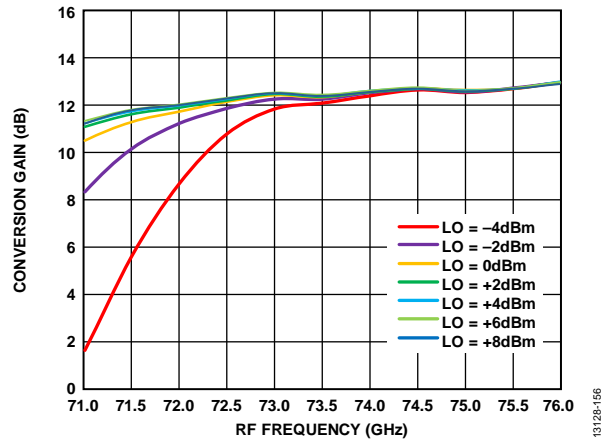

Figure 144. Conversion Gain vs. RF Frequency at Various LO Powers, $R_{FIN} = -20$ dBm, $I_F = 1000$ MHz, $V_{DLNA} = 3$ V

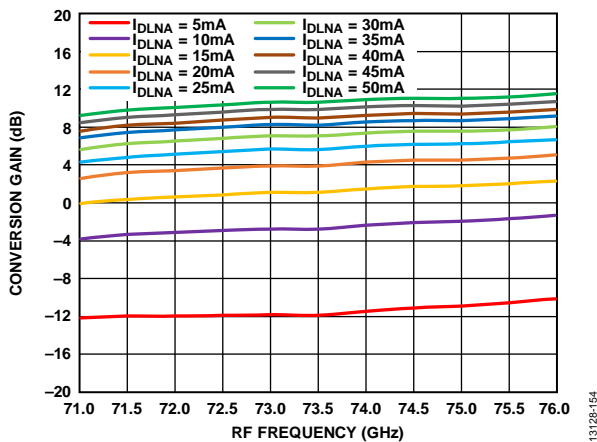

Figure 142. Conversion Gain vs. RF Frequency at Various I_{DLNA} Values, $R_{FIN} = -20$ dBm, $I_F = 1000$ MHz, $V_{DLNA} = 4$ V

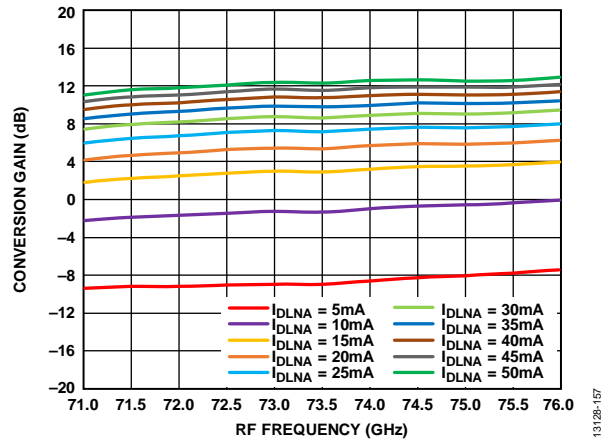

Figure 145. Conversion Gain vs. RF Frequency at Various I_{DLNA} Values, $R_{FIN} = -20$ dBm, $I_F = 1000$ MHz, $V_{DLNA} = 3$ V

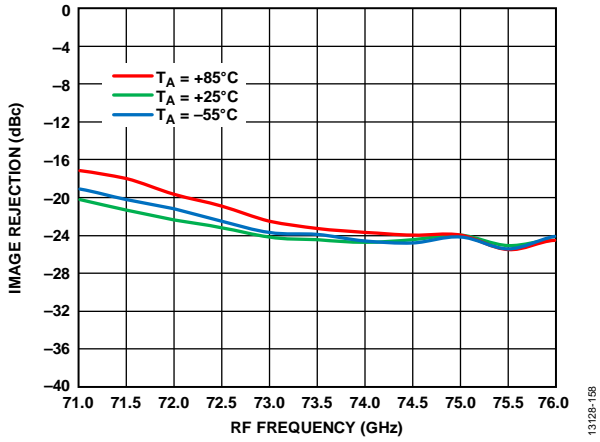

Figure 146. Image Rejection vs. RF Frequency at Various Temperatures, $R_{FIN} = -20$ dBm, $LO = 2$ dBm, $IF = 1000$ MHz, $V_{DLNA} = 4$ V

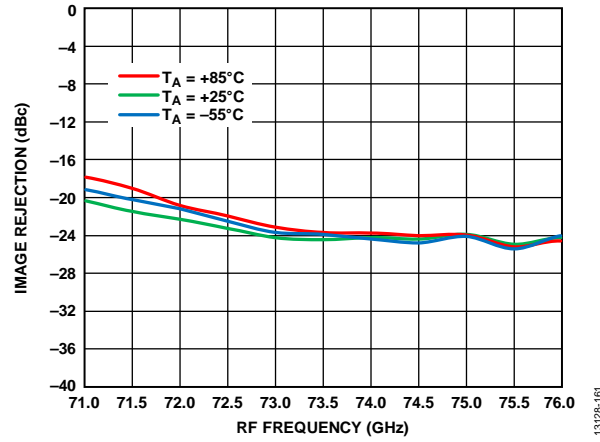

Figure 149. Image Rejection vs. RF Frequency at Various Temperatures, $R_{FIN} = -20$ dBm, $LO = 2$ dBm, $IF = 1000$ MHz, $V_{DLNA} = 3$ V

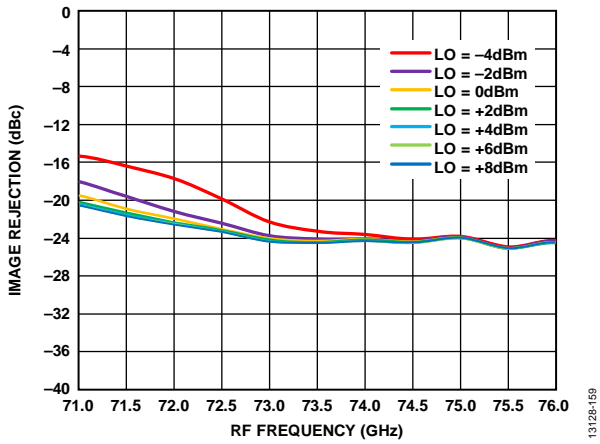

Figure 147. Image Rejection vs. RF Frequency at Various LO Powers, $R_{FIN} = -20$ dBm, $IF = 1000$ MHz, $V_{DLNA} = 4$ V

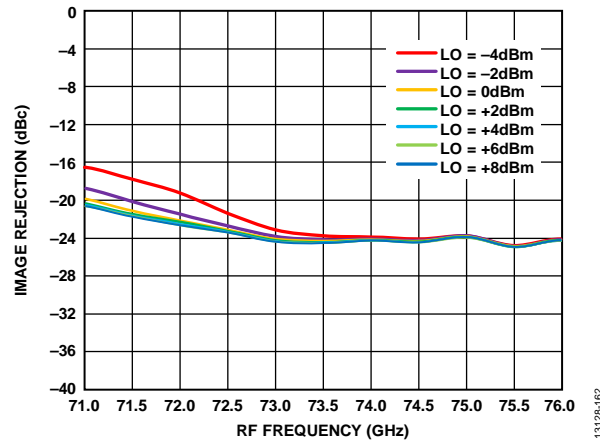

Figure 150. Image Rejection vs. RF Frequency at Various LO Powers, $R_{FIN} = -20$ dBm, $IF = 1000$ MHz, $V_{DLNA} = 3$ V

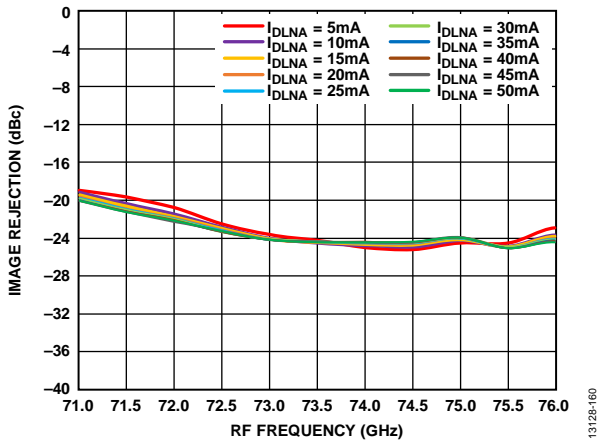

Figure 148. Image Rejection vs. RF Frequency at Various I_{DLNA} Values, $R_{FIN} = -20$ dBm, $LO = 2$ dBm, $IF = 1000$ MHz, $V_{DLNA} = 4$ V

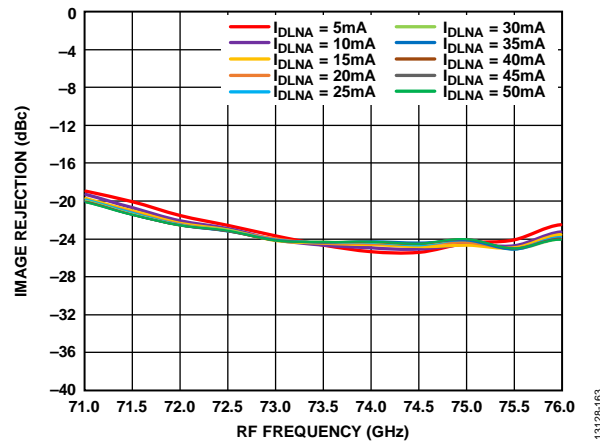

Figure 151. Image Rejection vs. RF Frequency at Various I_{DLNA} Values, $R_{FIN} = -20$ dBm, $LO = 2$ dBm, $IF = 1000$ MHz, $V_{DLNA} = 3$ V

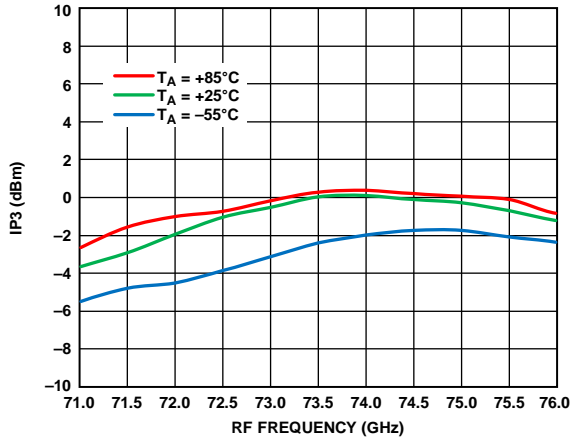

Figure 152. Input IP3 vs. RF Frequency at Various Temperatures, $R_{FIN} = -20$ dBm, LO = 2 dBm, IF = 1000 MHz, $V_{DLNA} = 4$ V

13128-164

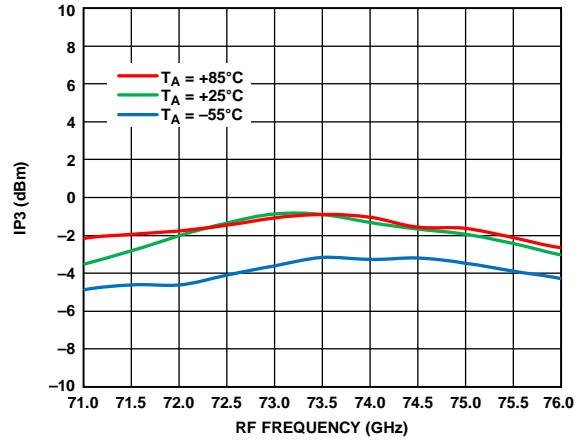

Figure 155. Input IP3 vs. RF Frequency at Various Temperatures, $R_{FIN} = -20$ dBm, LO = 2 dBm, IF = 1000 MHz, $V_{DLNA} = 3$ V

13128-167

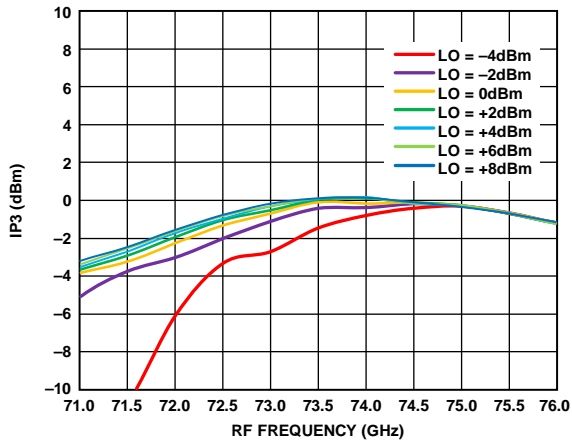

Figure 153. Input IP3 vs. RF Frequency at Various LO Powers, $R_{FIN} = -20$ dBm, IF = 1000 MHz, $V_{DLNA} = 4$ V

13128-165

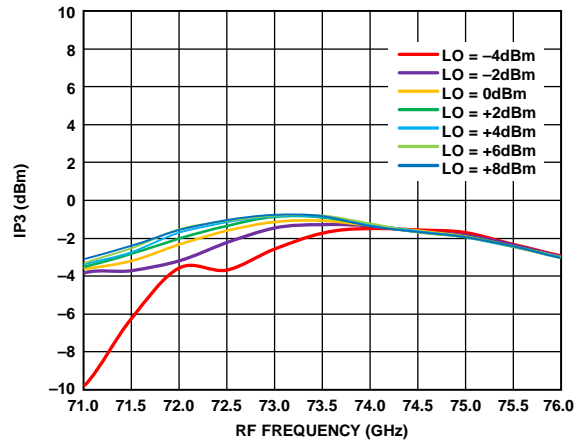

Figure 156. Input IP3 vs. RF Frequency at Various LO Powers, $R_{FIN} = -20$ dBm, IF = 1000 MHz, $V_{DLNA} = 3$ V

13128-168

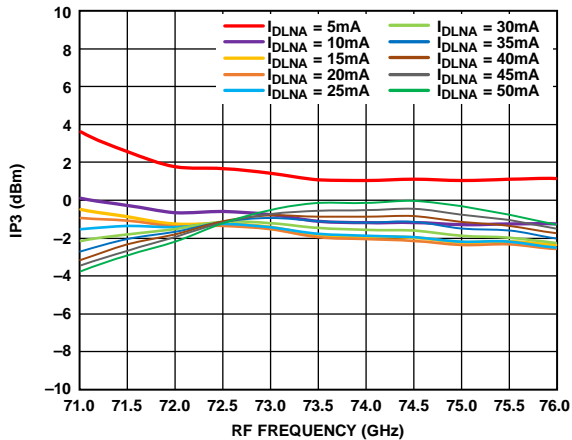

Figure 154. Input IP3 vs. RF Frequency at Various I_{DLNA} Values, $R_{FIN} = -20$ dBm, LO = 2 dBm, IF = 1000 MHz, $V_{DLNA} = 4$ V

13128-166

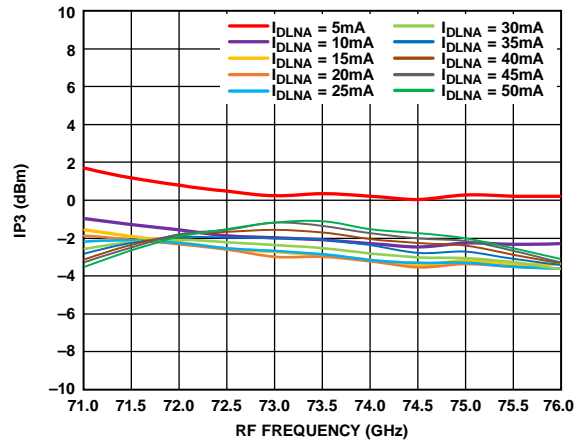
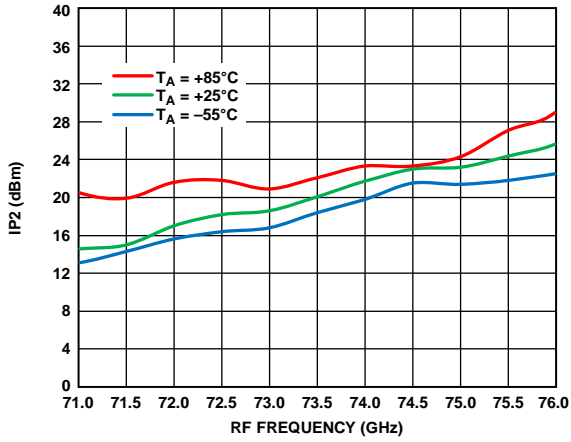

Figure 157. Input IP3 vs. RF Frequency at Various I_{DLNA} Values, $R_{FIN} = -20$ dBm, LO = 2 dBm, IF = 1000 MHz, $V_{DLNA} = 3$ V

13128-169



13128-170

Figure 158. Input IP2 vs. RF Frequency at Various Temperatures, $RF_{IN} = -20$ dBm, LO = 2 dBm, IF = 1000 MHz, $V_{DLNA} = 4$ V

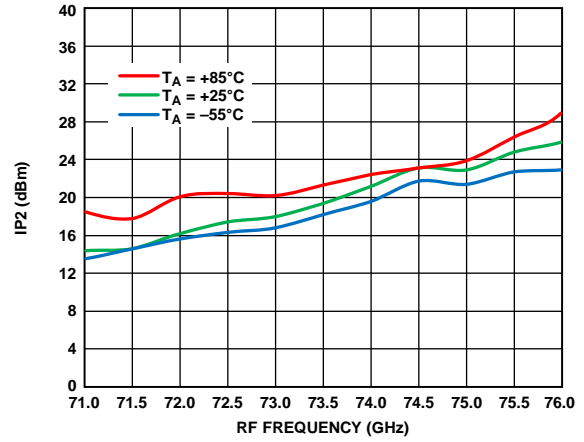

13128-173

Figure 161. Input IP2 vs. RF Frequency at Various Temperatures, $RF_{IN} = -20$ dBm, LO = 2 dBm, IF = 1000 MHz, $V_{DLNA} = 3$ V

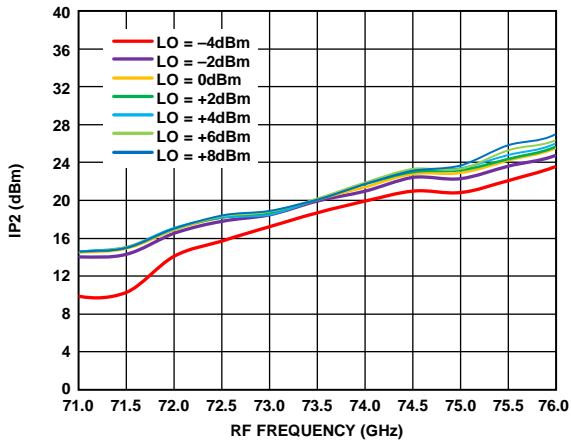

13128-171

Figure 159. Input IP2 vs. RF Frequency at Various LO Powers, $RF_{IN} = -20$ dBm, IF = 1000 MHz, $V_{DLNA} = 4$ V

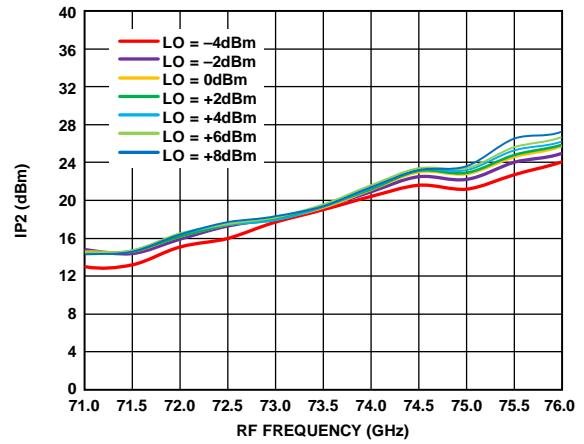

13128-174

Figure 162. Input IP2 vs. RF Frequency at Various LO Powers, $RF_{IN} = -20$ dBm, IF = 1000 MHz, $V_{DLNA} = 3$ V

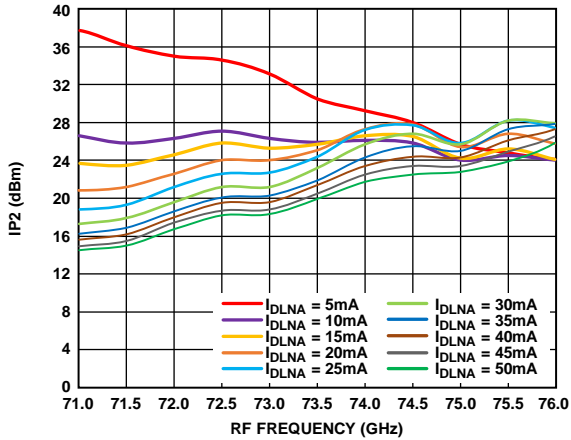

13128-172

Figure 160. Input IP2 vs. RF Frequency at Various I_{DLNA} Values, $RF_{IN} = -20$ dBm, LO = 2 dBm, IF = 1000 MHz, $V_{DLNA} = 4$ V

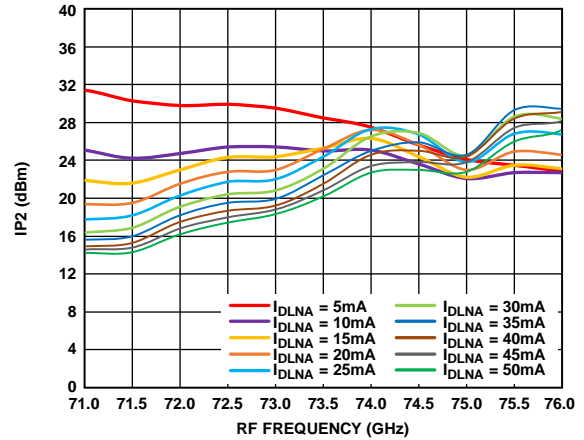

13128-175

Figure 163. Input IP2 vs. RF Frequency at Various I_{DLNA} Values, $RF_{IN} = -20$ dBm, LO = 2 dBm, IF = 1000 MHz, $V_{DLNA} = 3$ V

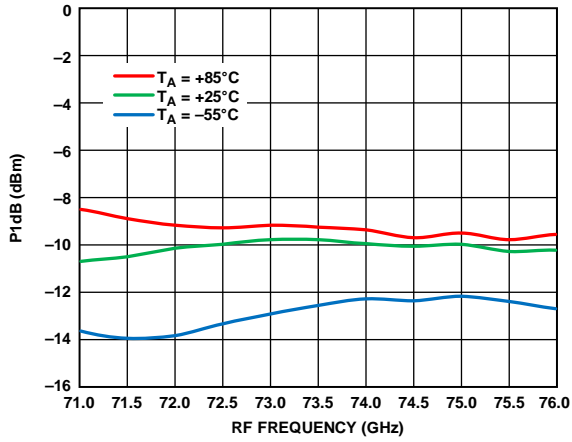

Figure 164. Input P1dB vs. RF Frequency at Various Temperatures, LO = 2 dBm, IF = 1000 MHz, V_{DLNA} = 4 V

13128-176

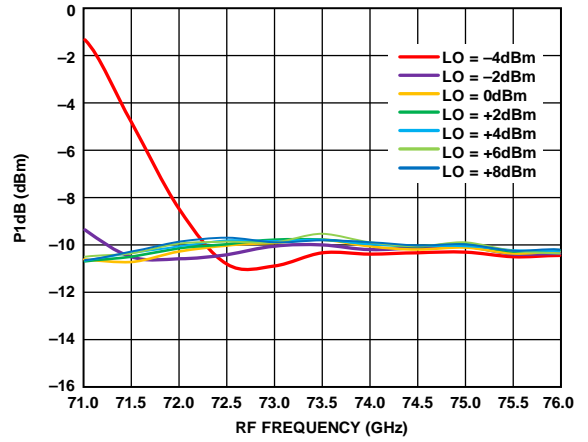
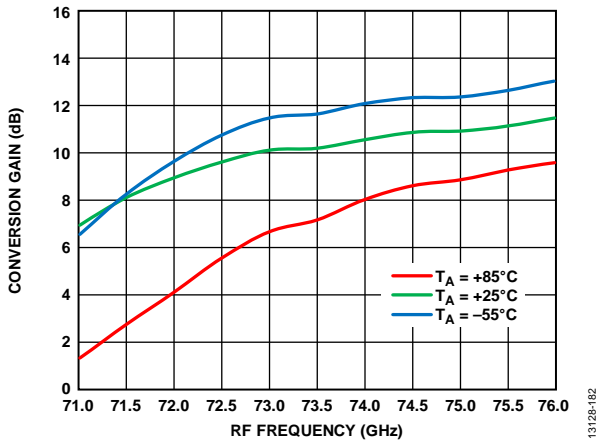

Figure 165. Input P1dB vs. RF Frequency at Various LO Powers, IF = 1000 MHz, V_{DLNA} = 4 V

13128-178

UPPER SIDEBAND SELECTED, IF = 2000 MHz



13128-182

Figure 166. Conversion Gain vs. RF Frequency at Various Temperatures, $R_{FIN} = -20$ dBm, LO = 2 dBm, IF = 2000 MHz, $V_{DLNA} = 4$ V

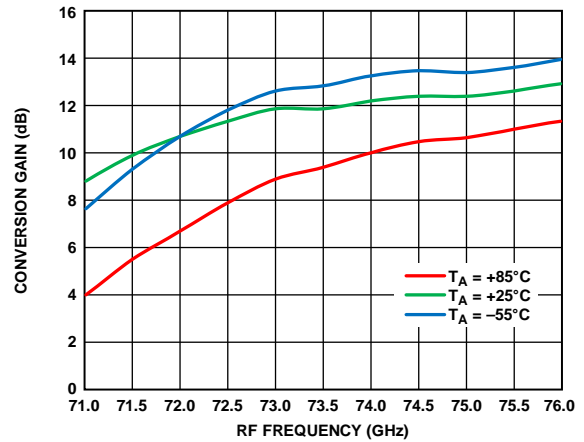

13128-185

Figure 169. Conversion Gain vs. RF Frequency at Various Temperatures, $R_{FIN} = -20$ dBm, LO = 2 dBm, IF = 2000 MHz, $V_{DLNA} = 3$ V

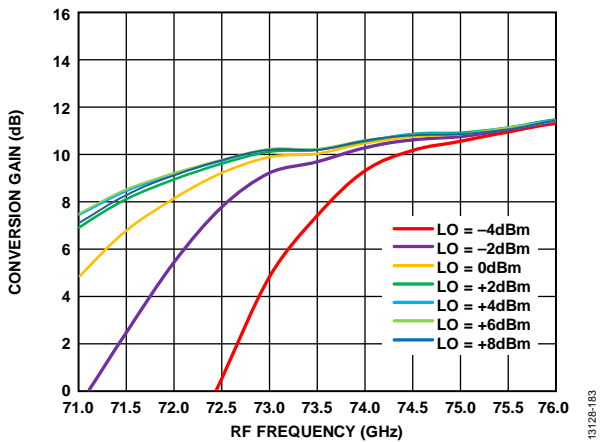

13128-183

Figure 167. Conversion Gain vs. RF Frequency at Various LO Powers, $R_{FIN} = -20$ dBm, IF = 2000 MHz, $V_{DLNA} = 4$ V

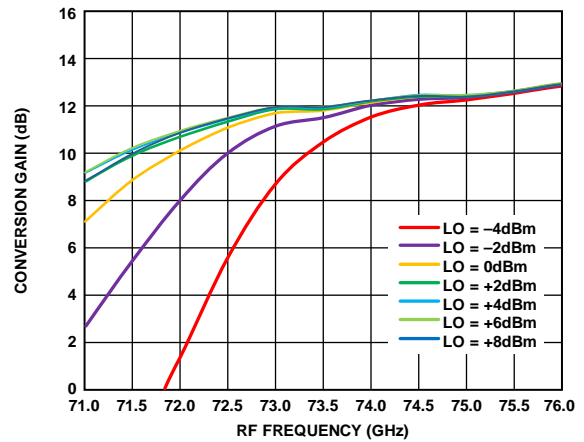

13128-186

Figure 170. Conversion Gain vs. RF Frequency at Various LO Powers, $R_{FIN} = -20$ dBm, IF = 2000 MHz, $V_{DLNA} = 3$ V

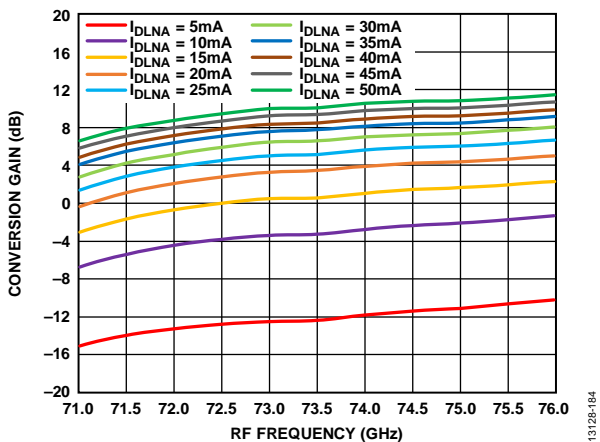

13128-184

Figure 168. Conversion Gain vs. RF Frequency at Various I_{DLNA} Values, $R_{FIN} = -20$ dBm, IF = 2000 MHz, $V_{DLNA} = 4$ V

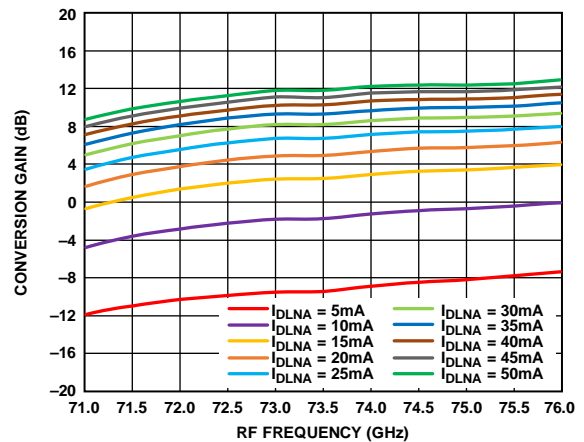

13128-187

Figure 171. Conversion Gain vs. RF Frequency at Various I_{DLNA} Values, $R_{FIN} = -20$ dBm, IF = 2000 MHz, $V_{DLNA} = 3$ V

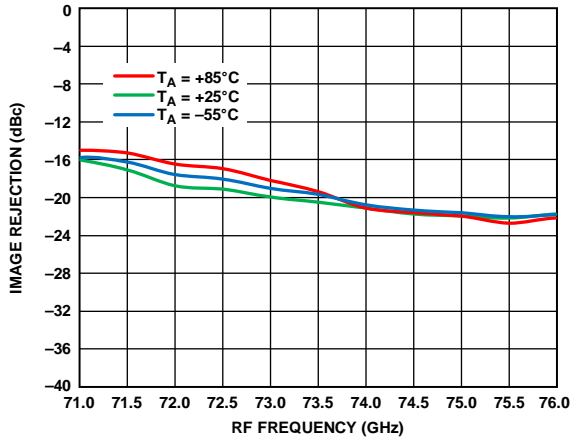

Figure 172. Image Rejection vs. RF Frequency at Various Temperatures, $R_{FIN} = -20$ dBm, $LO = 2$ dBm, $IF = 2000$ MHz, $V_{DLNA} = 4$ V

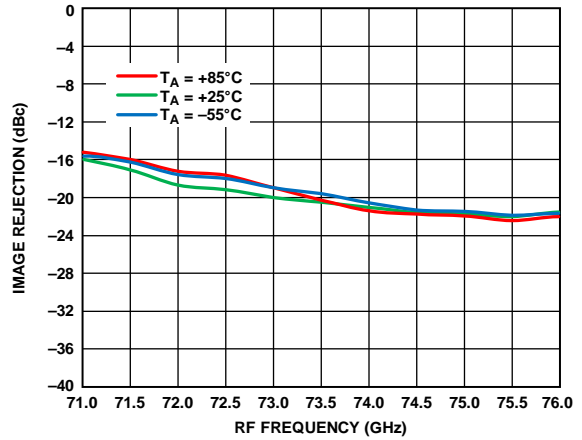

Figure 175. Image Rejection vs. RF Frequency at Various Temperatures, $R_{FIN} = -20$ dBm, $LO = 2$ dBm, $IF = 2000$ MHz, $V_{DLNA} = 3$ V

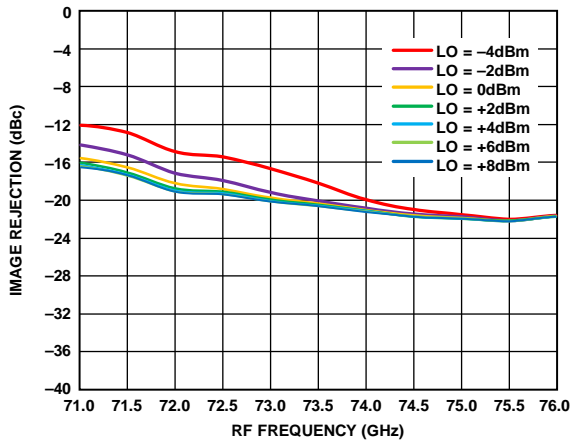

Figure 173. Image Rejection vs. RF Frequency at Various LO Powers, $R_{FIN} = -20$ dBm, $IF = 2000$ MHz, $V_{DLNA} = 4$ V

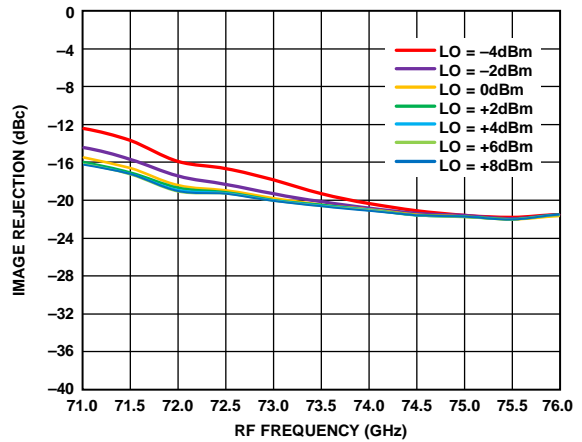

Figure 176. Image Rejection vs. RF Frequency at Various LO Powers, $R_{FIN} = -20$ dBm, $IF = 2000$ MHz, $V_{DLNA} = 3$ V

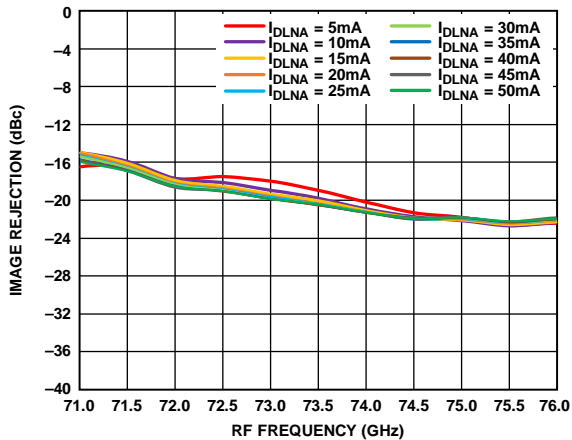

Figure 174. Image Rejection vs. RF Frequency at Various I_{DLNA} Values, $R_{FIN} = -20$ dBm, $LO = 2$ dBm, $IF = 2000$ MHz, $V_{DLNA} = 4$ V

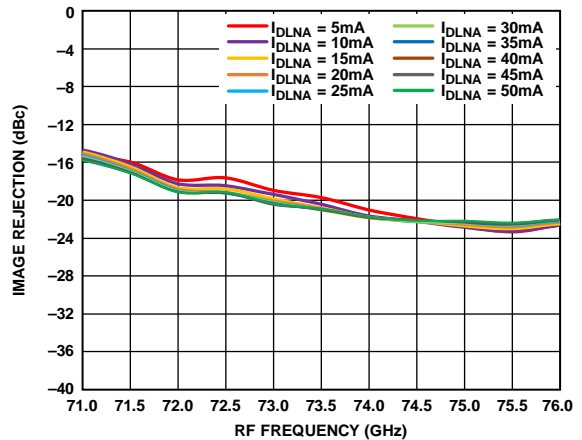
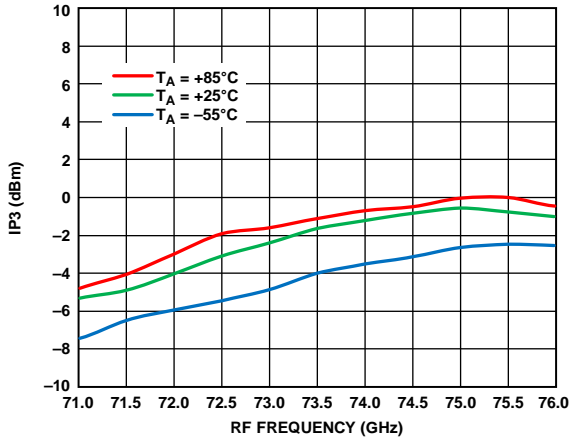
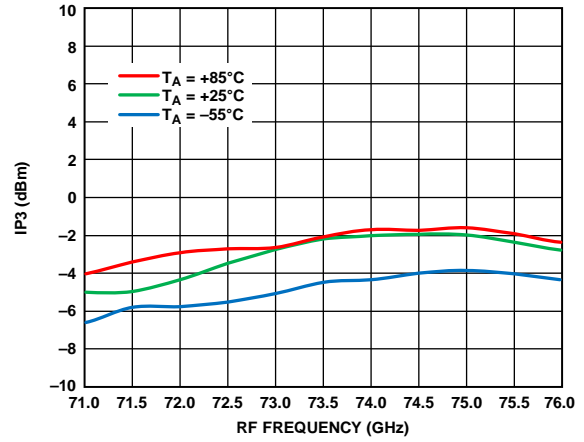

Figure 177. Image Rejection vs. RF Frequency at Various I_{DLNA} Values, $R_{FIN} = -20$ dBm, $LO = 2$ dBm, $IF = 2000$ MHz, $V_{DLNA} = 3$ V



13128-194

Figure 178. Input IP3 vs. RF Frequency at Various Temperatures, $R_{FIN} = -20$ dBm, $LO = 2$ dBm, $IF = 2000$ MHz, $V_{DLNA} = 4$ V



13128-197

Figure 181. Input IP3 vs. RF Frequency at Various Temperatures, $R_{FIN} = -20$ dBm, $LO = 2$ dBm, $IF = 2000$ MHz, $V_{DLNA} = 3$ V

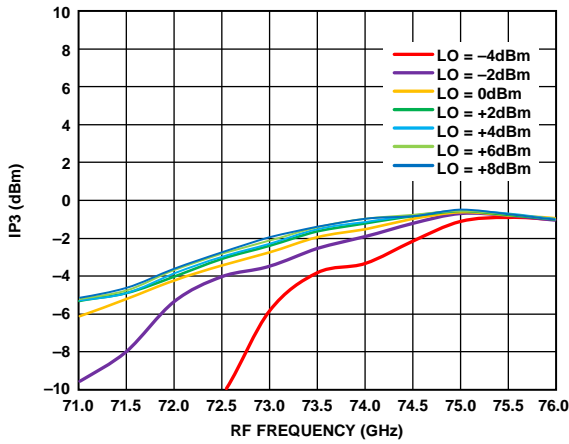

13128-195

Figure 179. Input IP3 vs. RF Frequency at Various LO Powers, $R_{FIN} = -20$ dBm, $IF = 2000$ MHz, $V_{DLNA} = 4$ V

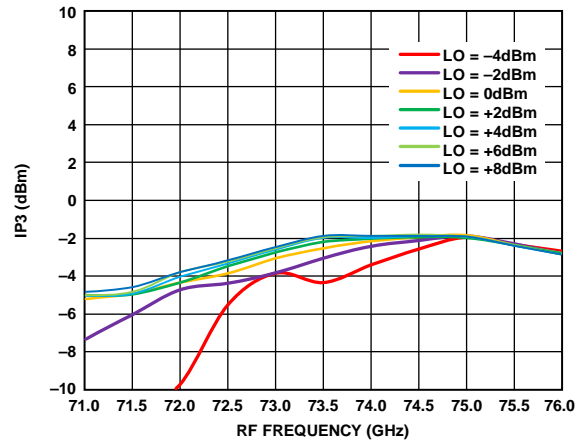

13128-198

Figure 182. Input IP3 vs. RF Frequency at Various LO Powers, $R_{FIN} = -20$ dBm, $IF = 2000$ MHz, $V_{DLNA} = 3$ V

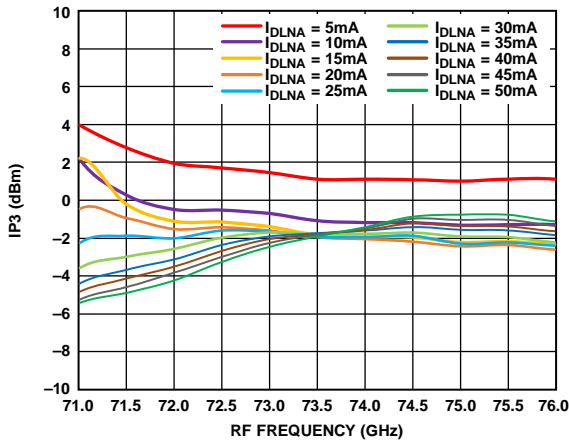

13128-196

Figure 180. Input IP3 vs. RF Frequency at Various I_{DLNA} Values, $R_{FIN} = -20$ dBm, $LO = 2$ dBm, $IF = 2000$ MHz, $V_{DLNA} = 4$ V

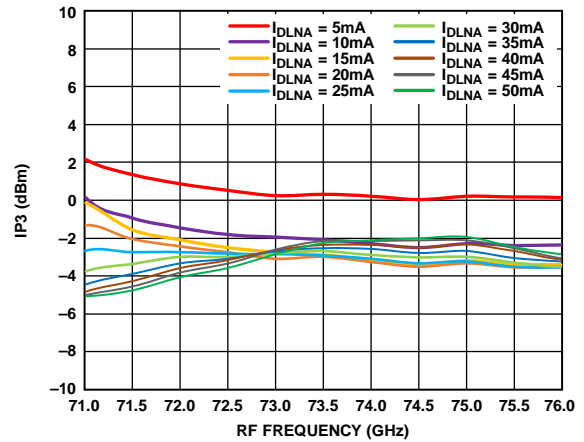

13128-199

Figure 183. Input IP3 vs. RF Frequency at Various I_{DLNA} Values, $R_{FIN} = -20$ dBm, $LO = 2$ dBm, $IF = 2000$ MHz, $V_{DLNA} = 3$ V

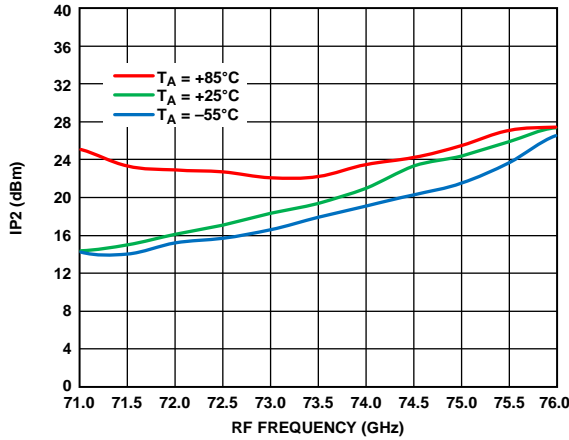

Figure 184. Input IP2 vs. RF Frequency at Various Temperatures, $R_{FIN} = -20$ dBm, $L_O = 2$ dBm, $I_F = 2000$ MHz, $V_{DLNA} = 4$ V

13128-200

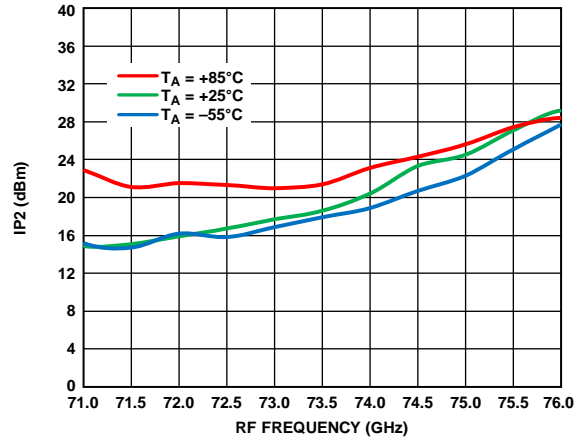

Figure 187. Input IP2 vs. RF Frequency at Various Temperatures, $R_{FIN} = -20$ dBm, $L_O = 2$ dBm, $I_F = 2000$ MHz, $V_{DLNA} = 3$ V

13128-203

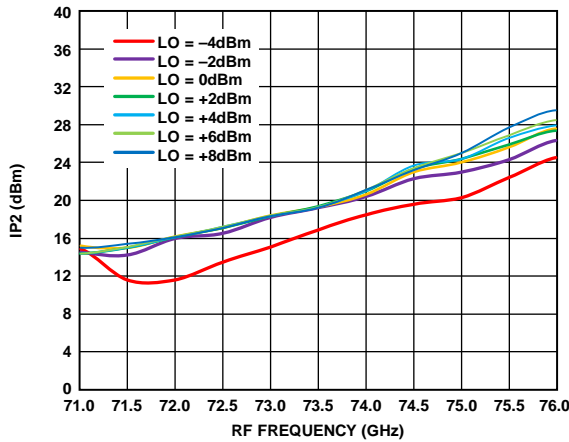

Figure 185. Input IP2 vs. RF Frequency at Various LO Powers, $R_{FIN} = -20$ dBm, $I_F = 2000$ MHz, $V_{DLNA} = 4$ V

13128-201

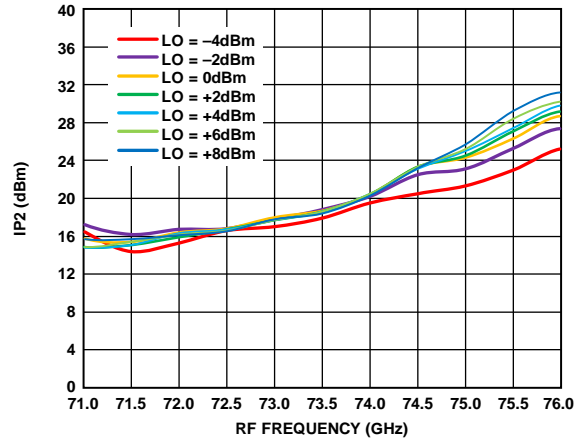

Figure 188. Input IP2 vs. RF Frequency at Various LO Powers, $R_{FIN} = -20$ dBm, $I_F = 2000$ MHz, $V_{DLNA} = 3$ V

13128-204

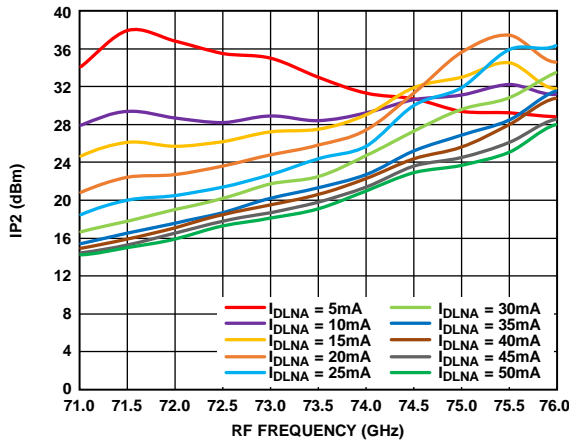

Figure 186. Input IP2 vs. RF Frequency at Various I_{DLNA} Values, $R_{FIN} = -20$ dBm, $L_O = 2$ dBm, $I_F = 2000$ MHz, $V_{DLNA} = 4$ V

13128-202

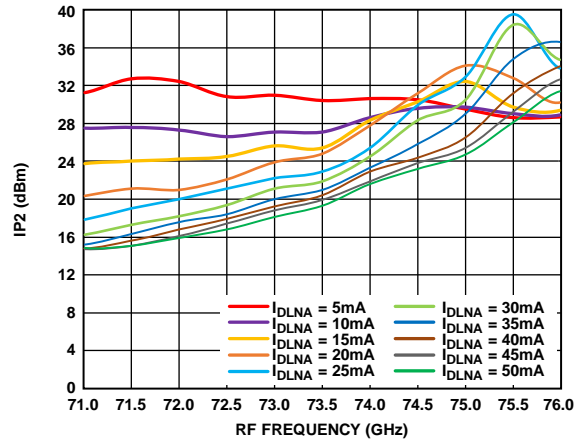

Figure 189. Input IP2 vs. RF Frequency at Various I_{DLNA} Values, $R_{FIN} = -20$ dBm, $L_O = 2$ dBm, $I_F = 2000$ MHz, $V_{DLNA} = 3$ V

13128-205

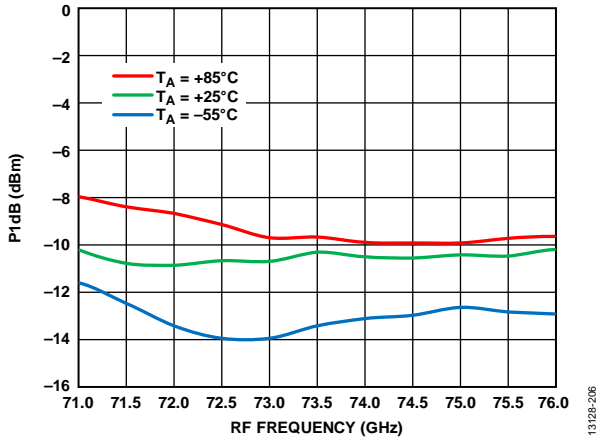

Figure 190. Input P1dB vs. RF Frequency at Various Temperatures, LO = 2 dBm, IF = 2000 MHz, V_{DLNA} = 4 V

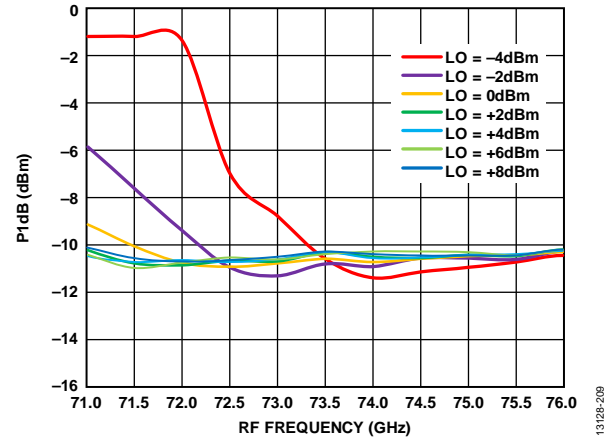

Figure 191. Input P1dB vs. RF Frequency at Various LO Powers, IF = 2000 MHz, V_{DLNA} = 4 V

13128-206

13128-209

NOISE FIGURE PERFORMANCE, UPPER SIDEBAND SELECTED

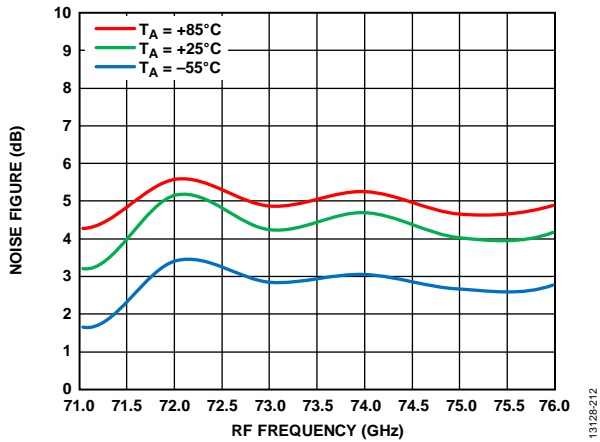

Figure 192. Noise Figure vs. RF Frequency at Various Temperatures, LO = 2 dBm, IF = 500 MHz, $V_{DLNA} = 3 V$

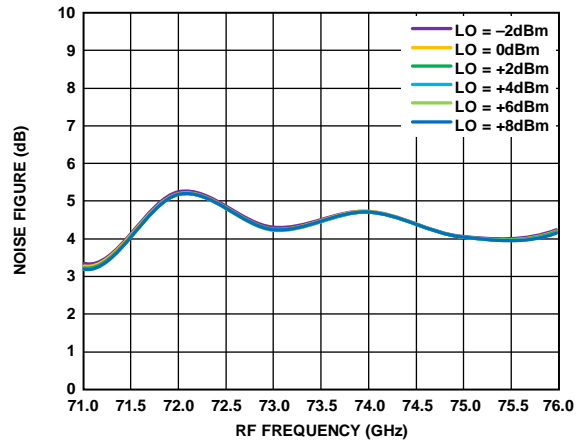

Figure 195. Noise Figure vs. RF Frequency at Various LO Powers, IF = 500 MHz, $V_{DLNA} = 3 V$

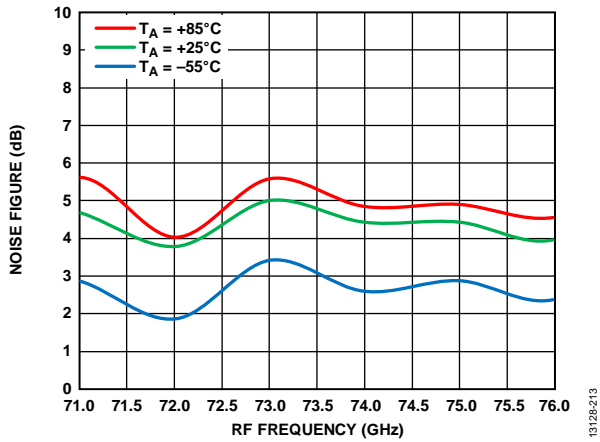

Figure 193. Noise Figure vs. RF Frequency at Various Temperatures, LO = 2 dBm, IF = 1000 MHz, $V_{DLNA} = 3 V$

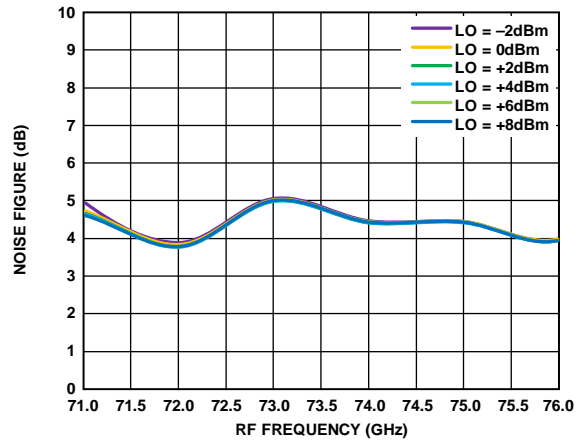

Figure 196. Noise Figure vs. RF Frequency at Various LO Powers, IF = 1000 MHz, $V_{DLNA} = 3 V$

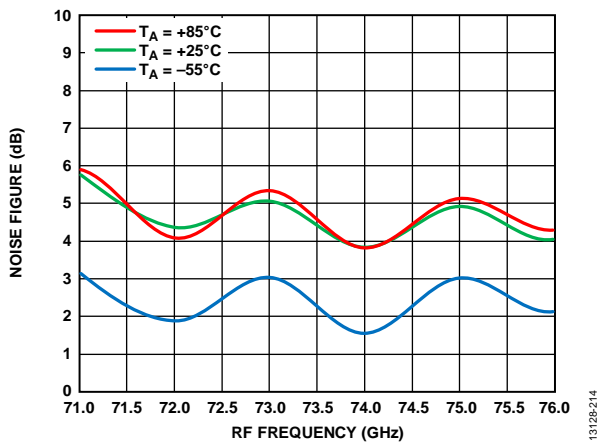

Figure 194. Noise Figure vs. RF Frequency at Various Temperatures, LO = 2 dBm, IF = 2000 MHz, $V_{DLNA} = 3 V$

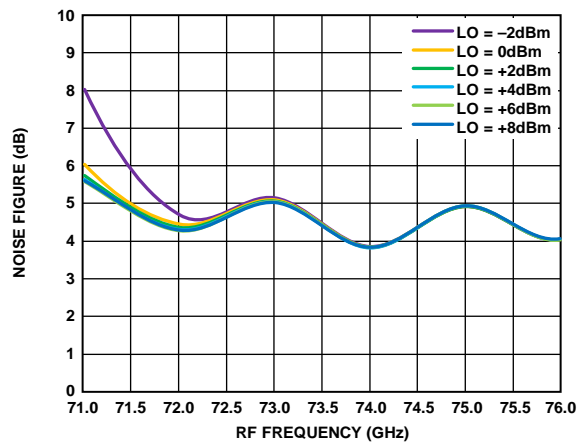

Figure 197. Noise Figure vs. RF Frequency at Various LO Powers, IF = 2000 MHz, $V_{DLNA} = 3 V$

AMPLITUDE BALANCE PERFORMANCE, UPPER SIDEBAND SELECTED

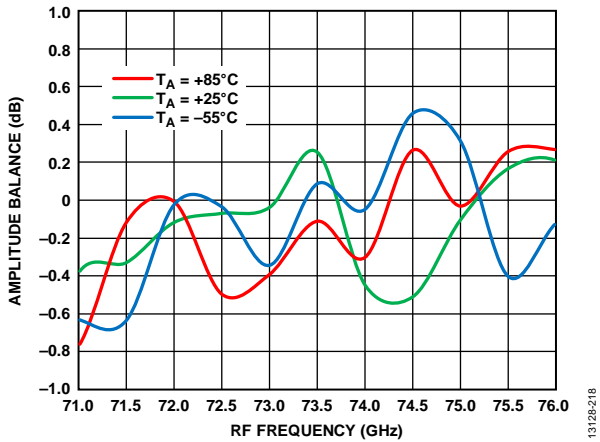

Figure 198. Amplitude Balance vs. RF Frequency at Various Temperatures, RFIN = -20 dBm, LO = 2 dBm, IF = 500 MHz, VDLNA = 4 V

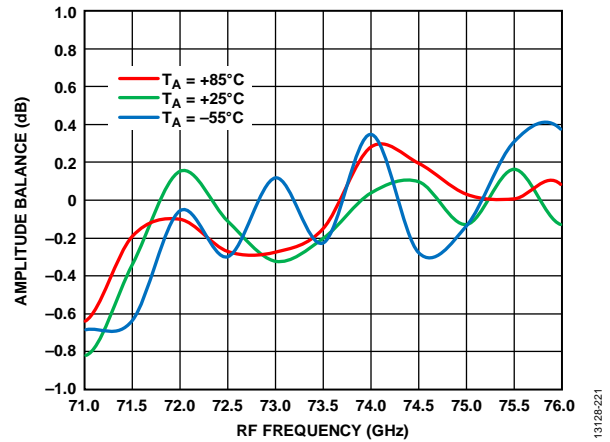

Figure 201. Amplitude Balance vs. RF Frequency at Various Temperatures, RFIN = -20 dBm, LO = 2 dBm, IF = 500 MHz, VDLNA = 3 V

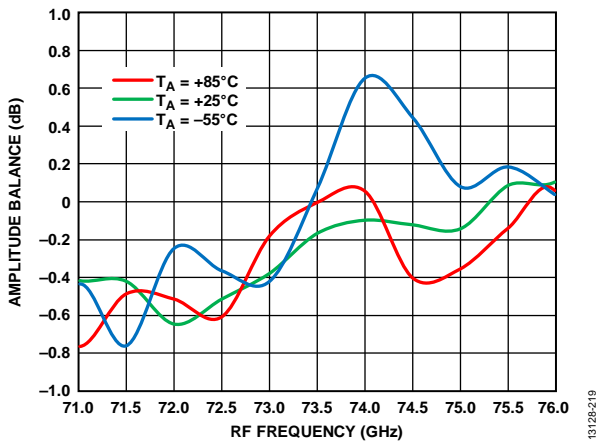

Figure 199. Amplitude Balance vs. RF Frequency at Various Temperatures, RFIN = -20 dBm, LO = 2 dBm, IF = 1000 MHz, VDLNA = 4 V

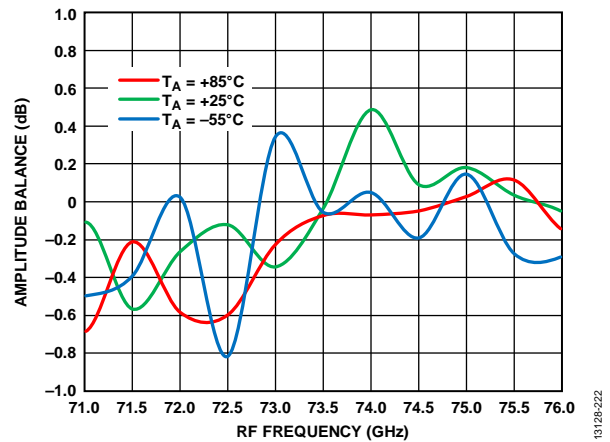

Figure 202. Amplitude Balance vs. RF Frequency at Various Temperatures, RFIN = -20 dBm, LO = 2 dBm, IF = 1000 MHz, VDLNA = 3 V

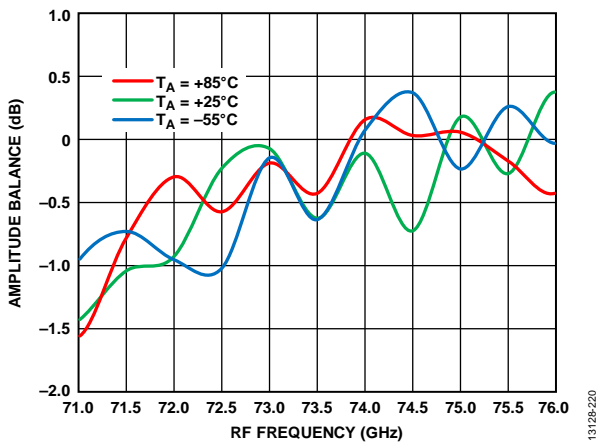

Figure 200. Amplitude Balance vs. RF Frequency at Various Temperatures, RFIN = -20 dBm, LO = 2 dBm, IF = 2000 MHz, VDLNA = 4 V

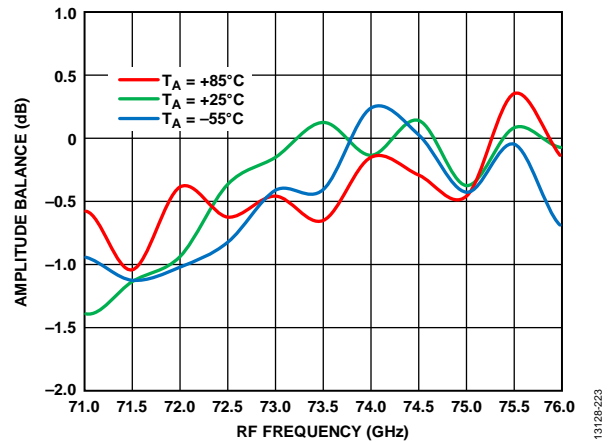

Figure 203. Amplitude Balance vs. RF Frequency at Various Temperatures, RFIN = -20 dBm, LO = 2 dBm, IF = 2000 MHz, VDLNA = 3 V

PHASE BALANCE PERFORMANCE, UPPER SIDEBAND SELECTED

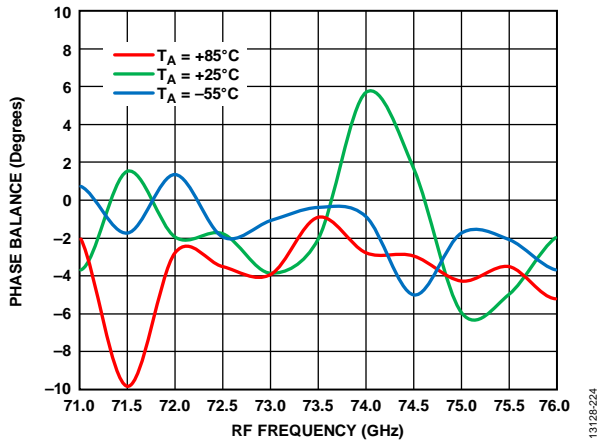

Figure 204. Phase Balance vs. RF Frequency at Various Temperatures, RFIN = -20 dBm, LO = 2 dBm, IF = 500 MHz, VDLNA = 4 V

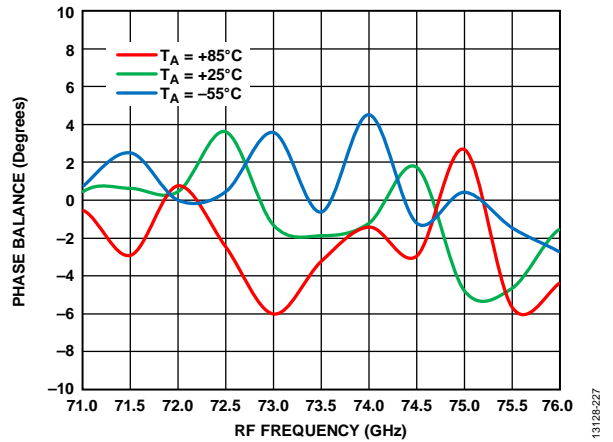

Figure 207. Phase Balance vs. RF Frequency at Various Temperatures, RFIN = -20 dBm, LO = 2 dBm, F = 500 MHz, VDLNA = 3 V

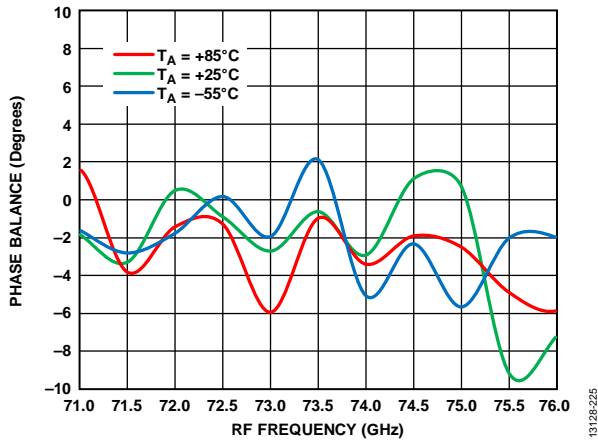

Figure 205. Phase Balance vs. RF Frequency at Various Temperatures, RFIN = -20 dBm, LO = 2 dBm, IF = 1000 MHz, VDLNA = 4 V

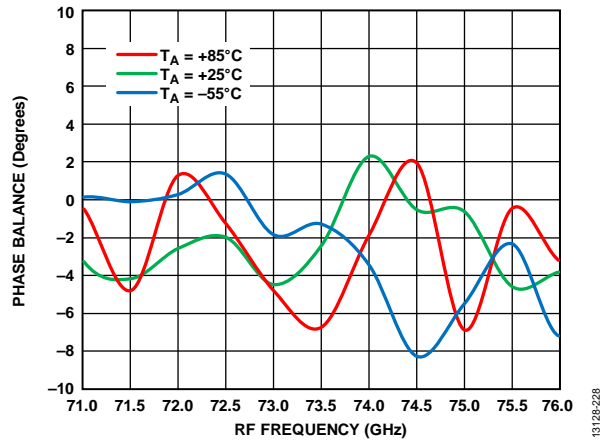

Figure 208. Phase Balance vs. RF Frequency at Various Temperatures, RFIN = -20 dBm, LO = 2 dBm, IF = 1000 MHz, VDLNA = 3 V

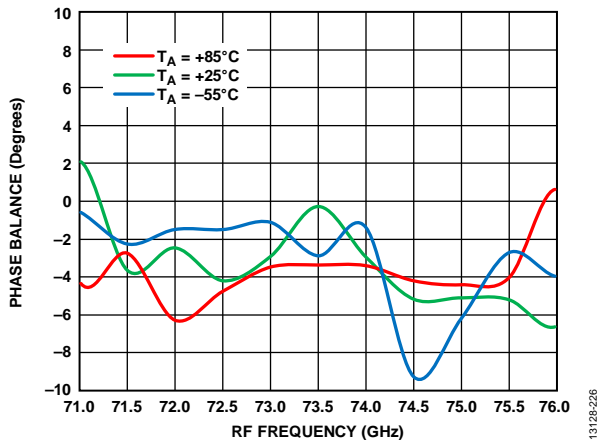

Figure 206. Phase Balance vs. RF Frequency at Various Temperatures, RFIN = -20 dBm, LO = 2 dBm, IF = 2000 MHz, VDLNA = 4 V

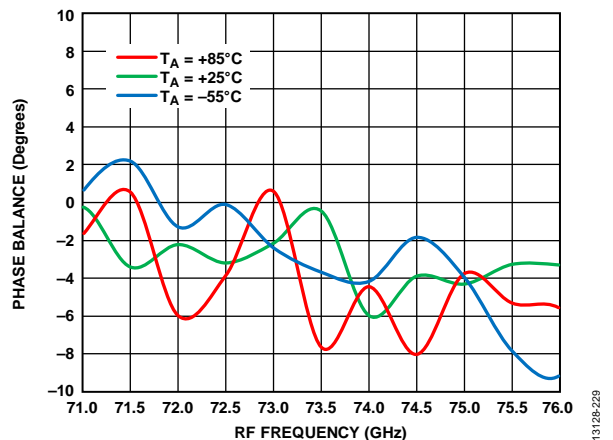

Figure 209. Phase Balance vs. RF Frequency at Various Temperatures, RFIN = -20 dBm, LO = 2 dBm, IF = 2000 MHz, VDLNA = 3 V

SPURIOUS PERFORMANCE WITH LOWER SIDEBAND SELECTED, IF = 500 MHz

$T_A = 25^\circ\text{C}$, $V_{\text{GMIX}} = -1\text{ V}$, $V_{\text{DAMPx}} = 4\text{ V}$, $V_{\text{DMULT}} = 1.5\text{ V}$, $\text{LOIN} = 2\text{ dBm}$. Mixer spurious products are measured in dBc from the IF output power level. Spur values are $(M \times \text{RF}) - (N \times \text{LO})$. N/A means not applicable.

$M \times N$ Spurious Outputs, $V_{\text{DLNA}} = 4\text{ V}$

RF = 71 GHz at $\text{RFIN} = -10\text{ dBm}$, LO frequency = 11.91 GHz at $\text{LOIN} = 2\text{ dBm}$.

		N × LO						
		0	1	2	3	4	5	6
M × RF	0	N/A	N/A	N/A	N/A	N/A	N/A	N/A
	1	N/A	N/A	N/A	N/A	N/A	N/A	N/A
	2	N/A	N/A	25.5	N/A	N/A	N/A	N/A
	3	N/A	N/A	N/A	34.8	N/A	N/A	N/A
	4	N/A	N/A	N/A	N/A	44.7	N/A	N/A
	5	N/A	N/A	N/A	N/A	N/A	48.9	N/A

RF = 73 GHz at $\text{RFIN} = -10\text{ dBm}$, LO frequency = 12.25 GHz at $\text{LOIN} = 2\text{ dBm}$.

		N × LO						
		0	1	2	3	4	5	6
M × RF	0	N/A	N/A	N/A	N/A	N/A	N/A	N/A
	1	N/A	N/A	N/A	N/A	N/A	N/A	N/A
	2	N/A	N/A	27	N/A	N/A	N/A	N/A
	3	N/A	N/A	N/A	37.6	N/A	N/A	N/A
	4	N/A	N/A	N/A	N/A	48.2	N/A	N/A
	5	N/A	N/A	N/A	N/A	N/A	53.9	N/A

RF = 76 GHz at $\text{RFIN} = -10\text{ dBm}$, LO frequency = 12.75 GHz at $\text{LOIN} = 2\text{ dBm}$.

		N × LO						
		0	1	2	3	4	5	6
M × RF	0	N/A	N/A	N/A	N/A	N/A	N/A	N/A
	1	N/A	N/A	N/A	N/A	N/A	N/A	N/A
	2	N/A	N/A	25.3	N/A	N/A	N/A	N/A
	3	N/A	N/A	N/A	37	N/A	N/A	N/A
	4	N/A	N/A	N/A	N/A	43.7	N/A	N/A
	5	N/A	N/A	N/A	N/A	N/A	56.5	N/A

$M \times N$ Spurious Outputs, $V_{\text{DLNA}} = 3\text{ V}$

RF = 71 GHz at $\text{RFIN} = -10\text{ dBm}$, LO frequency = 11.91 GHz at $\text{LOIN} = 2\text{ dBm}$.

		N × LO						
		0	1	2	3	4	5	6
M × RF	0	N/A	N/A	N/A	N/A	N/A	N/A	N/A
	1	N/A	N/A	N/A	N/A	N/A	N/A	N/A
	2	N/A	N/A	25.7	N/A	N/A	N/A	N/A
	3	N/A	N/A	N/A	34.1	N/A	N/A	N/A
	4	N/A	N/A	N/A	N/A	44	N/A	N/A
	5	N/A	N/A	N/A	N/A	N/A	48.4	N/A

RF = 73 GHz at $\text{RFIN} = -10\text{ dBm}$, LO frequency = 12.25 MHz at $\text{LOIN} = 2\text{ dBm}$.

		N × LO						
		0	1	2	3	4	5	6
M × RF	0	N/A	N/A	N/A	N/A	N/A	N/A	N/A
	1	N/A	N/A	N/A	N/A	N/A	N/A	N/A
	2	N/A	N/A	27	N/A	N/A	N/A	N/A
	3	N/A	N/A	N/A	36.2	N/A	N/A	N/A
	4	N/A	N/A	N/A	N/A	45.9	N/A	N/A
	5	N/A	N/A	N/A	N/A	N/A	51.1	N/A

RF = 76 GHz at $\text{RFIN} = -10\text{ dBm}$, LO frequency = 12.75 GHz at $\text{LOIN} = 2\text{ dBm}$.

		N × LO						
		0	1	2	3	4	5	6
M × RF	0	N/A	N/A	N/A	N/A	N/A	N/A	N/A
	1	N/A	N/A	N/A	N/A	N/A	N/A	N/A
	2	N/A	N/A	25.3	N/A	N/A	N/A	N/A
	3	N/A	N/A	N/A	35.6	N/A	N/A	N/A
	4	N/A	N/A	N/A	N/A	42.5	N/A	N/A
	5	N/A	N/A	N/A	N/A	N/A	54.7	N/A

SPURIOUS PERFORMANCE WITH LOWER SIDEBAND SELECTED, IF = 1000 MHz

$T_A = 25^\circ\text{C}$, $V_{\text{GMIX}} = -1\text{ V}$, $V_{\text{DAMPx}} = 4\text{ V}$, $V_{\text{DMULT}} = 1.5\text{ V}$, $\text{LOIN} = 2\text{ dBm}$. Mixer spurious products are measured in dBc from the IF output power level. Spur values are $(M \times \text{RF}) - (N \times \text{LO})$.

N/A means not applicable.

$M \times N$ Spurious Outputs, $V_{\text{DLNA}} = 4\text{ V}$

RF = 71 GHz at $\text{RFIN} = -10\text{ dBm}$, LO frequency = 12 GHz at $\text{LOIN} = 2\text{ dBm}$.

		N × LO						
		0	1	2	3	4	5	6
M × RF	0	N/A	N/A	N/A	N/A	N/A	N/A	N/A
	1	N/A	N/A	N/A	N/A	N/A	N/A	N/A
	2	N/A	N/A	26.6	N/A	N/A	N/A	N/A
	3	N/A	N/A	N/A	34.9	N/A	N/A	N/A
	4	N/A	N/A	N/A	N/A	44.8	N/A	N/A
	5	N/A	N/A	N/A	N/A	N/A	51.8	N/A

RF = 73 GHz at $\text{RFIN} = -10\text{ dBm}$, LO frequency = 12.33 MHz at $\text{LOIN} = 2\text{ dBm}$.

		N × LO						
		0	1	2	3	4	5	6
M × RF	0	N/A	N/A	N/A	N/A	N/A	N/A	N/A
	1	N/A	N/A	N/A	N/A	N/A	N/A	N/A
	2	N/A	N/A	27.8	N/A	N/A	N/A	N/A
	3	N/A	N/A	N/A	38.1	N/A	N/A	N/A
	4	N/A	N/A	N/A	N/A	47.7	N/A	N/A
	5	N/A	N/A	N/A	N/A	N/A	55.1	N/A

RF = 76 GHz at $\text{RFIN} = -10\text{ dBm}$, LO frequency = 12.83 GHz at $\text{LOIN} = 2\text{ dBm}$.

		N × LO						
		0	1	2	3	4	5	6
M × RF	0	N/A	N/A	N/A	N/A	N/A	N/A	N/A
	1	N/A	N/A	N/A	N/A	N/A	N/A	N/A
	2	N/A	N/A	26.2	N/A	N/A	N/A	N/A
	3	N/A	N/A	N/A	37.8	N/A	N/A	N/A
	4	N/A	N/A	N/A	N/A	46	N/A	N/A
	5	N/A	N/A	N/A	N/A	N/A	59.4	N/A

$M \times N$ Spurious Outputs, $V_{\text{DLNA}} = 3\text{ V}$

RF = 71 GHz at $\text{RFIN} = -10\text{ dBm}$, LO frequency = 12 GHz at $\text{LOIN} = 2\text{ dBm}$.

		N × LO						
		0	1	2	3	4	5	6
M × RF	0	N/A	N/A	N/A	N/A	N/A	N/A	N/A
	1	N/A	N/A	N/A	N/A	N/A	N/A	N/A
	2	N/A	N/A	26.9	N/A	N/A	N/A	N/A
	3	N/A	N/A	N/A	33.9	N/A	N/A	N/A
	4	N/A	N/A	N/A	N/A	43.6	N/A	N/A
	5	N/A	N/A	N/A	N/A	N/A	50.5	N/A

RF = 73 GHz at $\text{RFIN} = -10\text{ dBm}$, LO frequency = 12.33 MHz at $\text{LOIN} = 2\text{ dBm}$.

		N × LO						
		0	1	2	3	4	5	6
M × RF	0	N/A	N/A	N/A	N/A	N/A	N/A	N/A
	1	N/A	N/A	N/A	N/A	N/A	N/A	N/A
	2	N/A	N/A	27.8	N/A	N/A	N/A	N/A
	3	N/A	N/A	N/A	36.6	N/A	N/A	N/A
	4	N/A	N/A	N/A	N/A	45.8	N/A	N/A
	5	N/A	N/A	N/A	N/A	N/A	53	N/A

RF = 76 GHz at $\text{RFIN} = -10\text{ dBm}$, LO frequency = 12.83 GHz at $\text{LOIN} = 2\text{ dBm}$.

		N × LO						
		0	1	2	3	4	5	6
M × RF	0	N/A	N/A	N/A	N/A	N/A	N/A	N/A
	1	N/A	N/A	N/A	N/A	N/A	N/A	N/A
	2	N/A	N/A	26.1	N/A	N/A	N/A	N/A
	3	N/A	N/A	N/A	36.2	N/A	N/A	N/A
	4	N/A	N/A	N/A	N/A	44.8	N/A	N/A
	5	N/A	N/A	N/A	N/A	N/A	56.7	N/A

SPURIOUS PERFORMANCE WITH LOWER SIDEBAND SELECTED, IF = 2000 MHz

$T_A = 25^\circ\text{C}$, $V_{\text{GMIX}} = -1\text{ V}$, $V_{\text{DAMPx}} = 4\text{ V}$, $V_{\text{DMULT}} = 1.5\text{ V}$, $\text{LOIN} = 2\text{ dBm}$. Mixer spurious products are measured in dBc from the IF output power level. Spur values are $(M \times \text{RF}) - (N \times \text{LO})$. N/A means not applicable.

$M \times N$ Spurious Outputs, $V_{\text{DLNA}} = 4\text{ V}$

RF = 71 GHz at $\text{RFIN} = -10\text{ dBm}$, LO frequency = 12.16 GHz at $\text{LOIN} = 2\text{ dBm}$.

		N × LO						
		0	1	2	3	4	5	6
M × RF	0	N/A	N/A	N/A	N/A	N/A	N/A	N/A
	1	N/A	N/A	N/A	N/A	N/A	N/A	N/A
	2	N/A	N/A	28	N/A	N/A	N/A	N/A
	3	N/A	N/A	N/A	39.7	N/A	N/A	N/A
	4	N/A	N/A	N/A	N/A	46.7	N/A	N/A
	5	N/A	N/A	N/A	N/A	N/A	56.7	N/A

RF = 73 GHz at $\text{RFIN} = -10\text{ dBm}$, LO frequency = 12.5 MHz at $\text{LOIN} = 2\text{ dBm}$.

		N × LO						
		0	1	2	3	4	5	6
M × RF	0	N/A	N/A	N/A	N/A	N/A	N/A	N/A
	1	N/A	N/A	N/A	N/A	N/A	N/A	N/A
	2	N/A	N/A	29.15	N/A	N/A	N/A	N/A
	3	N/A	N/A	N/A	40.7	N/A	N/A	N/A
	4	N/A	N/A	N/A	N/A	47.1	N/A	N/A
	5	N/A	N/A	N/A	N/A	N/A	57.5	N/A

RF = 76 GHz at $\text{RFIN} = -10\text{ dBm}$, LO frequency = 13 GHz at $\text{LOIN} = 2\text{ dBm}$.

		N × LO						
		0	1	2	3	4	5	6
M × RF	0	N/A	N/A	N/A	N/A	N/A	N/A	N/A
	1	N/A	N/A	N/A	N/A	N/A	N/A	N/A
	2	N/A	N/A	27.6	N/A	N/A	N/A	N/A
	3	N/A	N/A	N/A	40.6	N/A	N/A	N/A
	4	N/A	N/A	N/A	N/A	50.4	N/A	N/A
	5	N/A	N/A	N/A	N/A	N/A	63.4	N/A

$M \times N$ Spurious Outputs, $V_{\text{DLNA}} = 3\text{ V}$

RF = 71 GHz at $\text{RFIN} = -10\text{ dBm}$, LO frequency = 12.16 GHz at $\text{LOIN} = 2\text{ dBm}$.

		N × LO						
		0	1	2	3	4	5	6
M × RF	0	N/A	N/A	N/A	N/A	N/A	N/A	N/A
	1	N/A	N/A	N/A	N/A	N/A	N/A	N/A
	2	N/A	N/A	28	N/A	N/A	N/A	N/A
	3	N/A	N/A	N/A	37.3	N/A	N/A	N/A
	4	N/A	N/A	N/A	N/A	44.1	N/A	N/A
	5	N/A	N/A	N/A	N/A	N/A	54.4	N/A

RF = 73 GHz at $\text{RFIN} = -10\text{ dBm}$, LO frequency = 12.5 MHz at $\text{LOIN} = 2\text{ dBm}$.

		N × LO						
		0	1	2	3	4	5	6
M × RF	0	N/A	N/A	N/A	N/A	N/A	N/A	N/A
	1	N/A	N/A	N/A	N/A	N/A	N/A	N/A
	2	N/A	N/A	29.5	N/A	N/A	N/A	N/A
	3	N/A	N/A	N/A	38.5	N/A	N/A	N/A
	4	N/A	N/A	N/A	N/A	45.3	N/A	N/A
	5	N/A	N/A	N/A	N/A	N/A	55.5	N/A

RF = 76 GHz at $\text{RFIN} = -10\text{ dBm}$, LO frequency = 13 GHz at $\text{LOIN} = 2\text{ dBm}$.

		N × LO						
		0	1	2	3	4	5	6
M × RF	0	N/A	N/A	N/A	N/A	N/A	N/A	N/A
	1	N/A	N/A	N/A	N/A	N/A	N/A	N/A
	2	N/A	N/A	27.1	N/A	N/A	N/A	N/A
	3	N/A	N/A	N/A	38.8	N/A	N/A	N/A
	4	N/A	N/A	N/A	N/A	48.8	N/A	N/A
	5	N/A	N/A	N/A	N/A	N/A	61	N/A

SPURIOUS PERFORMANCE WITH UPPER SIDEBAND SELECTED, IF = 500 MHz

$T_A = 25^\circ\text{C}$, $V_{\text{GMIX}} = -1\text{ V}$, $V_{\text{DAMPx}} = 4\text{ V}$, $V_{\text{DMULT}} = 1.5\text{ V}$, $\text{LOIN} = 2\text{ dBm}$. Mixer spurious products are measured in dBc from the IF output power level. Spur values are $(M \times \text{RF}) - (N \times \text{LO})$.

N/A means not applicable.

$M \times N$ Spurious Outputs, $V_{\text{DLNA}} = 4\text{ V}$

RF = 71 GHz at $\text{RFIN} = -10\text{ dBm}$, LO frequency = 11.75 GHz at $\text{LOIN} = 2\text{ dBm}$.

		N × LO						
		0	1	2	3	4	5	6
M × RF	0	N/A	N/A	N/A	N/A	N/A	N/A	N/A
	1	N/A	N/A	N/A	N/A	N/A	N/A	N/A
	2	N/A	N/A	24.8	N/A	N/A	N/A	N/A
	3	N/A	N/A	N/A	36	N/A	N/A	N/A
	4	N/A	N/A	N/A	N/A	46.7	N/A	N/A
	5	N/A	N/A	N/A	N/A	N/A	49.4	N/A

RF = 73 GHz at $\text{RFIN} = -10\text{ dBm}$, LO frequency = 12.08 GHz at $\text{LOIN} = 2\text{ dBm}$.

		N × LO						
		0	1	2	3	4	5	6
M × RF	0	N/A	N/A	N/A	N/A	N/A	N/A	N/A
	1	N/A	N/A	N/A	N/A	N/A	N/A	N/A
	2	N/A	N/A	25.8	N/A	N/A	N/A	N/A
	3	N/A	N/A	N/A	35.6	N/A	N/A	N/A
	4	N/A	N/A	N/A	N/A	46.4	N/A	N/A
	5	N/A	N/A	N/A	N/A	N/A	51.3	N/A

RF = 76 GHz at $\text{RFIN} = -10\text{ dBm}$, LO frequency = 12.58 GHz at $\text{LOIN} = 2\text{ dBm}$.

		N × LO						
		0	1	2	3	4	5	6
M × RF	0	N/A	N/A	N/A	N/A	N/A	N/A	N/A
	1	N/A	N/A	N/A	N/A	N/A	N/A	N/A
	2	N/A	N/A	24.2	N/A	N/A	N/A	N/A
	3	N/A	N/A	N/A	36.5	N/A	N/A	N/A
	4	N/A	N/A	N/A	N/A	44.5	N/A	N/A
	5	N/A	N/A	N/A	N/A	N/A	55.6	N/A

$M \times N$ Spurious Outputs, $V_{\text{DLNA}} = 3\text{ V}$

RF = 71 GHz at $\text{RFIN} = -10\text{ dBm}$, LO frequency = 11.75 GHz at $\text{LOIN} = 2\text{ dBm}$.

		N × LO						
		0	1	2	3	4	5	6
M × RF	0	N/A	N/A	N/A	N/A	N/A	N/A	N/A
	1	N/A	N/A	N/A	N/A	N/A	N/A	N/A
	2	N/A	N/A	24.4	N/A	N/A	N/A	N/A
	3	N/A	N/A	N/A	35.2	N/A	N/A	N/A
	4	N/A	N/A	N/A	N/A	45.6	N/A	N/A
	5	N/A	N/A	N/A	N/A	N/A	53	N/A

RF = 73 GHz at $\text{RFIN} = -10\text{ dBm}$, LO frequency = 12.08 MHz at $\text{LOIN} = 2\text{ dBm}$.

		N × LO						
		0	1	2	3	4	5	6
M × RF	0	N/A	N/A	N/A	N/A	N/A	N/A	N/A
	1	N/A	N/A	N/A	N/A	N/A	N/A	N/A
	2	N/A	N/A	25.5	N/A	N/A	N/A	N/A
	3	N/A	N/A	N/A	34.1	N/A	N/A	N/A
	4	N/A	N/A	N/A	N/A	44.5	N/A	N/A
	5	N/A	N/A	N/A	N/A	N/A	48.7	N/A

RF = 76 GHz at $\text{RFIN} = -10\text{ dBm}$, LO frequency = 12.58 GHz at $\text{LOIN} = 2\text{ dBm}$.

		N × LO						
		0	1	2	3	4	5	6
M × RF	0	N/A	N/A	N/A	N/A	N/A	N/A	N/A
	1	N/A	N/A	N/A	N/A	N/A	N/A	N/A
	2	N/A	N/A	24	N/A	N/A	N/A	N/A
	3	N/A	N/A	N/A	34.9	N/A	N/A	N/A
	4	N/A	N/A	N/A	N/A	44	N/A	N/A
	5	N/A	N/A	N/A	N/A	N/A	53.3	N/A

SPURIOUS PERFORMANCE WITH UPPER SIDEBAND SELECTED, IF = 1000 MHz

T_A = 25°C, V_{GMIX} = -1 V, V_{DAMPx} = 4 V, V_{DMULT} = 1.5 V, LOIN = 2 dBm. Mixer spurious products are measured in dBc from the IF output power level. Spur values are (M × RF) – (N × LO). N/A means not applicable.

M × N Spurious Outputs, V_{DLNA} = 4 V

RF = 71 GHz at RFIN = -10 dBm, LO frequency = 11.66 GHz at LOIN = 2 dBm.

		N × LO						
		0	1	2	3	4	5	6
M × RF	0	N/A	N/A	N/A	N/A	N/A	N/A	N/A
	1	N/A	N/A	N/A	N/A	N/A	N/A	N/A
	2	N/A	N/A	25.2	N/A	N/A	N/A	N/A
	3	N/A	N/A	N/A	37.4	N/A	N/A	N/A
	4	N/A	N/A	N/A	N/A	50.2	N/A	N/A
	5	N/A	N/A	N/A	N/A	N/A	50.8	N/A

RF = 73 GHz at RFIN = -10 dBm, LO frequency = 12 GHz at LOIN = 2 dBm.

		N × LO						
		0	1	2	3	4	5	6
M × RF	0	N/A	N/A	N/A	N/A	N/A	N/A	N/A
	1	N/A	N/A	N/A	N/A	N/A	N/A	N/A
	2	N/A	N/A	25.6	N/A	N/A	N/A	N/A
	3	N/A	N/A	N/A	34.4	N/A	N/A	N/A
	4	N/A	N/A	N/A	N/A	46	N/A	N/A
	5	N/A	N/A	N/A	N/A	N/A	49.5	N/A

RF = 76 GHz at RFIN = -10 dBm, LO frequency = 12.5 GHz at LOIN = 2 dBm.

		N × LO						
		0	1	2	3	4	5	6
M × RF	0	N/A	N/A	N/A	N/A	N/A	N/A	N/A
	1	N/A	N/A	N/A	N/A	N/A	N/A	N/A
	2	N/A	N/A	24.8	N/A	N/A	N/A	N/A
	3	N/A	N/A	N/A	36.5	N/A	N/A	N/A
	4	N/A	N/A	N/A	N/A	46.1	N/A	N/A
	5	N/A	N/A	N/A	N/A	N/A	55.2	N/A

M × N Spurious Outputs, V_{DLNA} = 3 V

RF = 71 GHz at RFIN = -10 dBm, LO frequency = 11.66 GHz at LOIN = 2 dBm.

		N × LO						
		0	1	2	3	4	5	6
M × RF	0	N/A	N/A	N/A	N/A	N/A	N/A	N/A
	1	N/A	N/A	N/A	N/A	N/A	N/A	N/A
	2	N/A	N/A	24.6	N/A	N/A	N/A	N/A
	3	N/A	N/A	N/A	37.1	N/A	N/A	N/A
	4	N/A	N/A	N/A	N/A	47.6	N/A	N/A
	5	N/A	N/A	N/A	N/A	N/A	57.7	N/A

RF = 73 GHz at RFIN = -10 dBm, LO frequency = 12 GHz at LOIN = 2 dBm.

		N × LO						
		0	1	2	3	4	5	6
M × RF	0	N/A	N/A	N/A	N/A	N/A	N/A	N/A
	1	N/A	N/A	N/A	N/A	N/A	N/A	N/A
	2	N/A	N/A	25.3	N/A	N/A	N/A	N/A
	3	N/A	N/A	N/A	33.2	N/A	N/A	N/A
	4	N/A	N/A	N/A	N/A	44.2	N/A	N/A
	5	N/A	N/A	N/A	N/A	N/A	47.6	N/A

RF = 76 GHz at RFIN = -10 dBm, LO frequency = 12.5 GHz at LOIN = 2 dBm.

		N × LO						
		0	1	2	3	4	5	6
M × RF	0	N/A	N/A	N/A	N/A	N/A	N/A	N/A
	1	N/A	N/A	N/A	N/A	N/A	N/A	N/A
	2	N/A	N/A	24.6	N/A	N/A	N/A	N/A
	3	N/A	N/A	N/A	34.7	N/A	N/A	N/A
	4	N/A	N/A	N/A	N/A	44.4	N/A	N/A
	5	N/A	N/A	N/A	N/A	N/A	52.9	N/A

SPURIOUS PERFORMANCE WITH UPPER SIDEBAND SELECTED, IF = 2000 MHz

$T_A = 25^\circ\text{C}$, $V_{\text{GMIX}} = -1\text{ V}$, $V_{\text{DAMPx}} = 4\text{ V}$, $V_{\text{DMULT}} = 1.5\text{ V}$, $\text{LOIN} = 2\text{ dBm}$. Mixer spurious products are measured in dBc from the IF output power level. Spur values are $(M \times \text{RF}) - (N \times \text{LO})$.

N/A means not applicable.

$M \times N$ Spurious Outputs, $V_{\text{DLNA}} = 4\text{ V}$

RF = 71 GHz at $\text{RFIN} = -10\text{ dBm}$, LO frequency = 11.5 GHz at $\text{LOIN} = 2\text{ dBm}$.

		N × LO						
		0	1	2	3	4	5	6
M × RF	0	N/A	N/A	N/A	N/A	N/A	N/A	N/A
	1	N/A	N/A	N/A	N/A	N/A	N/A	N/A
	2	N/A	N/A	25.6	N/A	N/A	N/A	N/A
	3	N/A	N/A	N/A	41.2	N/A	N/A	N/A
	4	N/A	N/A	N/A	N/A	49.5	N/A	N/A
	5	N/A	N/A	N/A	N/A	N/A	59.4	N/A

RF = 73 GHz at $\text{RFIN} = -10\text{ dBm}$, LO frequency = 11.83 GHz at $\text{LOIN} = 2\text{ dBm}$.

		N × LO						
		0	1	2	3	4	5	6
M × RF	0	N/A	N/A	N/A	N/A	N/A	N/A	N/A
	1	N/A	N/A	N/A	N/A	N/A	N/A	N/A
	2	N/A	N/A	24.8	N/A	N/A	N/A	N/A
	3	N/A	N/A	N/A	32	N/A	N/A	N/A
	4	N/A	N/A	N/A	N/A	44.2	N/A	N/A
	5	N/A	N/A	N/A	N/A	N/A	48.6	N/A

RF = 76 GHz at $\text{RFIN} = -10\text{ dBm}$, LO frequency = 12.33 GHz at $\text{LOIN} = 2\text{ dBm}$.

		N × LO						
		0	1	2	3	4	5	6
M × RF	0	N/A	N/A	N/A	N/A	N/A	N/A	N/A
	1	N/A	N/A	N/A	N/A	N/A	N/A	N/A
	2	N/A	N/A	24.4	N/A	N/A	N/A	N/A
	3	N/A	N/A	N/A	36.8	N/A	N/A	N/A
	4	N/A	N/A	N/A	N/A	47.2	N/A	N/A
	5	N/A	N/A	N/A	N/A	N/A	54.6	N/A

$M \times N$ Spurious Outputs, $V_{\text{DLNA}} = 3\text{ V}$

RF = 71 GHz at $\text{RFIN} = -10\text{ dBm}$, LO frequency = 11.5 GHz at $\text{LOIN} = 2\text{ dBm}$.

		N × LO						
		0	1	2	3	4	5	6
M × RF	0	N/A	N/A	N/A	N/A	N/A	N/A	N/A
	1	N/A	N/A	N/A	N/A	N/A	N/A	N/A
	2	N/A	N/A	25.3	N/A	N/A	N/A	N/A
	3	N/A	N/A	N/A	40.1	N/A	N/A	N/A
	4	N/A	N/A	N/A	N/A	46.3	N/A	N/A
	5	N/A	N/A	N/A	N/A	N/A	66.4	N/A

RF = 73 GHz at $\text{RFIN} = -10\text{ dBm}$, LO frequency = 11.83 GHz at $\text{LOIN} = 2\text{ dBm}$.

		N × LO						
		0	1	2	3	4	5	6
M × RF	0	N/A	N/A	N/A	N/A	N/A	N/A	N/A
	1	N/A	N/A	N/A	N/A	N/A	N/A	N/A
	2	N/A	N/A	24.5	N/A	N/A	N/A	N/A
	3	N/A	N/A	N/A	36.1	N/A	N/A	N/A
	4	N/A	N/A	N/A	N/A	42.6	N/A	N/A
	5	N/A	N/A	N/A	N/A	N/A	48.1	N/A

RF = 76 GHz at $\text{RFIN} = -10\text{ dBm}$, LO frequency = 12.33 GHz at $\text{LOIN} = 2\text{ dBm}$.

		N × LO						
		0	1	2	3	4	5	6
M × RF	0	N/A	N/A	N/A	N/A	N/A	N/A	N/A
	1	N/A	N/A	N/A	N/A	N/A	N/A	N/A
	2	N/A	N/A	23.9	N/A	N/A	N/A	N/A
	3	N/A	N/A	N/A	35.5	N/A	N/A	N/A
	4	N/A	N/A	N/A	N/A	45	N/A	N/A
	5	N/A	N/A	N/A	N/A	N/A	52.2	N/A

THEORY OF OPERATION

The HMC7586 is a GaAs low noise I/Q downconverter with an integrated LO buffer and a 6× multiplier. See Figure 210 for a functional block diagram of the downconverter circuit architecture.

The RF input is internally ac-coupled and matched to 50 Ω. The input passes through four stages of low noise amplification. The preamplified RF input signal then splits and drives two singly

balanced passive mixers. Quadrature LO signals drive the two I and Q mixer cores. The LO path provides a 6× multiplier that allows the use of a lower frequency range LO input signal, typically between 11.83 GHz and 14.33 GHz. The 6× multiplier is implemented using a cascade of 3× and 2× multipliers. The LO buffer amplifiers are included on chip to allow a typical LO drive level of only 2 dBm for full performance.

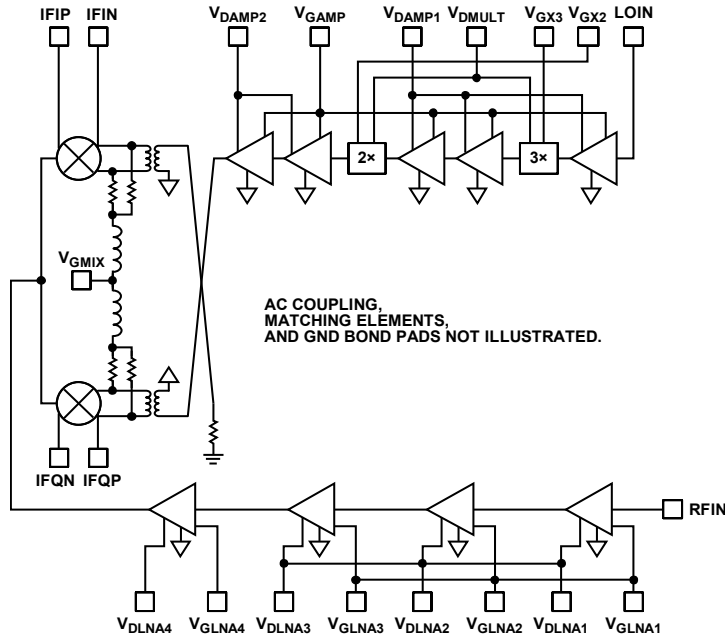

Figure 210. Downconverter Circuit Architecture

13128-230

APPLICATIONS INFORMATION

BIASING SEQUENCE

The HMC7586 uses several amplifier and multiplier stages. The active stages all utilize depletion mode pHEMT transistors. It is important to follow the following power-up bias sequence to ensure transistor damage does not occur.

1. Apply a -2 V bias to V_{GAMP} , V_{GLNA1} , V_{GLNA2} , V_{GLNA3} , V_{GLNA4} , V_{GX2} , and V_{GX3} .
2. Apply a -1 V bias to V_{GMIX} .
3. Apply 4 V to V_{DAMP1} , V_{DAMP2} , V_{DLNA1} , V_{DLNA2} , V_{DLNA3} , and V_{DLNA4} , and apply 1.5 V to V_{DMULT} .
4. Adjust V_{GAMP} between -2 V and 0 V to achieve a total amplifier drain current ($I_{DAMP1} + I_{DAMP2}$) of 175 mA .
5. Adjust V_{GLNA1} , V_{GLNA2} , V_{GLNA3} , and V_{GLNA4} to achieve a total LNA drain current ($I_{DLNA1} + I_{DLNA2} + I_{DLNA3} + I_{DLNA4}$) of 50 mA .
6. Apply an LO input signal with a power level of $\sim 2\text{ dBm}$ and adjust V_{GX2} and V_{GX3} between 2 V and 0 V to achieve 80 mA of drain current on V_{DMULT} .

To power down the HMC7586, follow the reverse procedure.

For additional guidance on general bias sequencing, see the [MMIC Amplifier Biasing Procedure](#) application note.

IMAGE REJECTION DOWNCONVERSION

A typical image rejection downconversion application circuit is shown in Figure 211. For image rejection downconversion, external 180° and 90° hybrid couplers are typically used. The 180° hybrids or baluns convert the differential I and Q output signals to unbalanced waveforms. The 90° hybrid then combines the outputs in quadrature to form a classic Hartley image rejection receiver with a typical image rejection of 28 dBc .

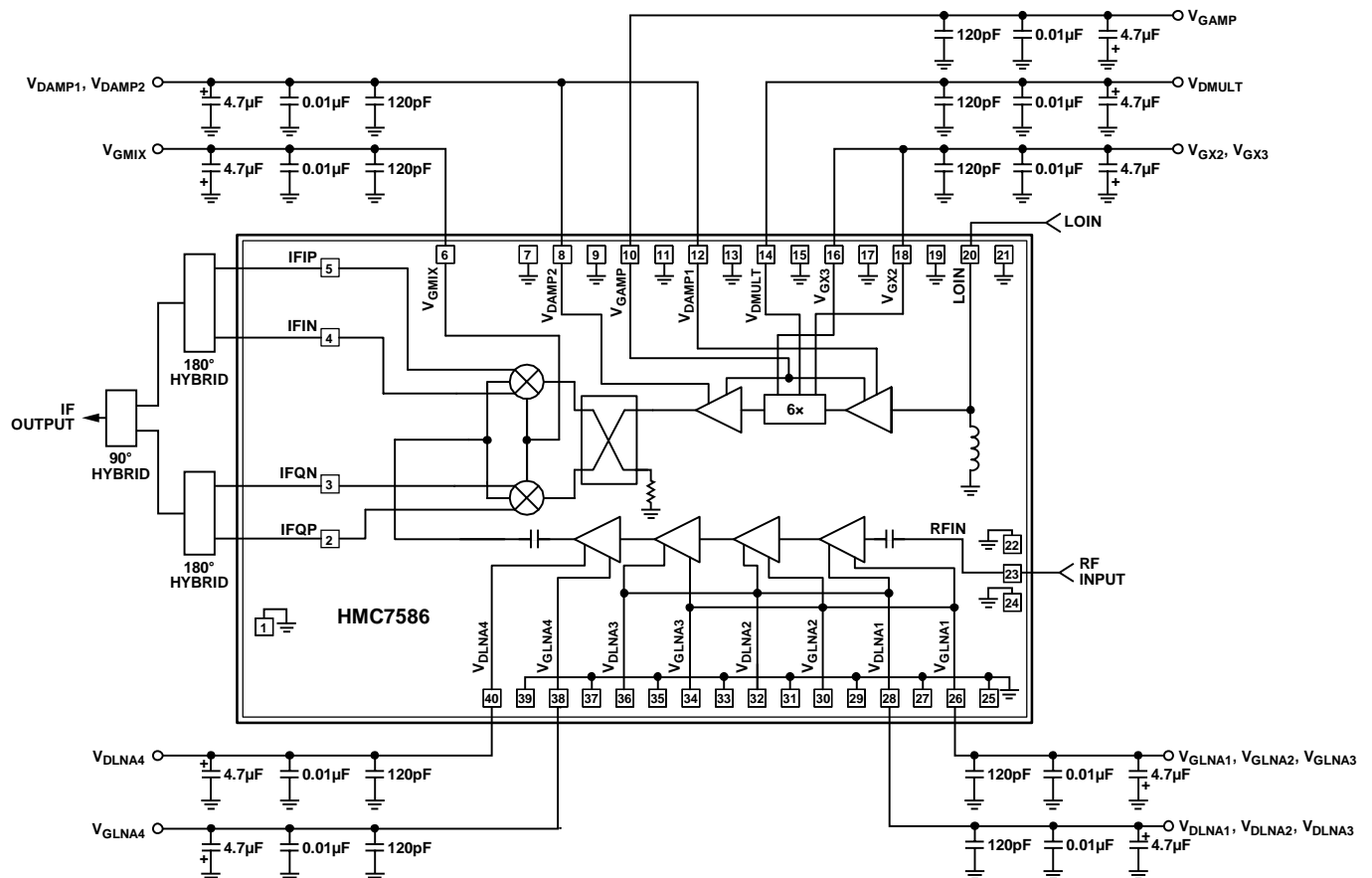

Figure 211. Typical Image Rejection Downconversion Application Circuit

13158-231

ZERO IF DIRECT CONVERSION

A typical zero IF direct conversion application circuit is shown in Figure 212. It is important to ac couple the IFIP, IFIN, IFQP, and IFQN pads to the ADC inputs. Most ADCs are designed to operate with a common-mode voltage that is above ground.

The HMC7586 I/Q outputs are ground referenced, and dc coupling to a differential signal source with a common-mode output voltage other than 0 V may cause degraded RF performance and possible device damage due to electrical overstress.

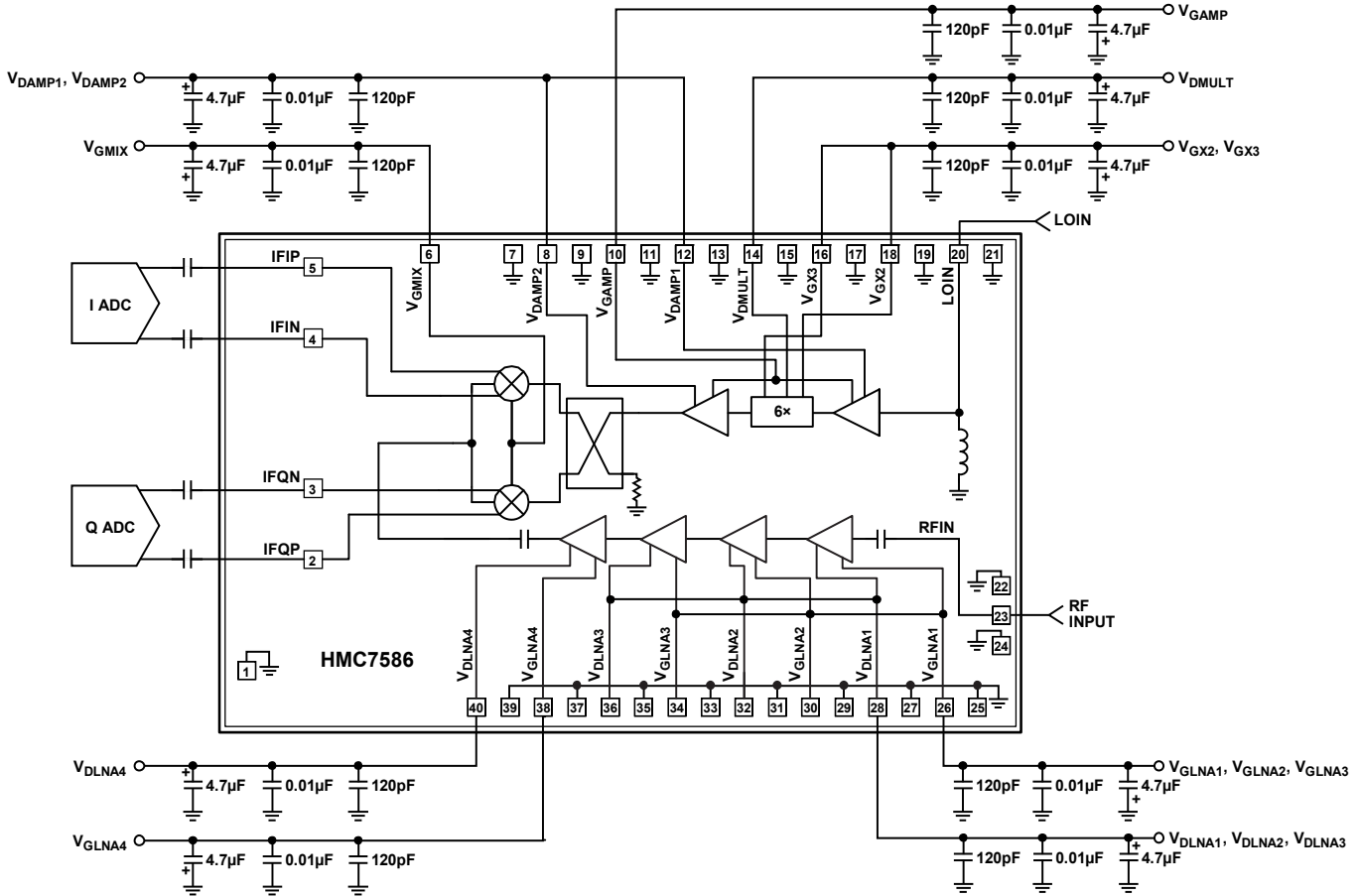

Figure 212. Typical Zero IF Direct Conversion Application Circuit

1312E-232

ASSEMBLY DIAGRAM

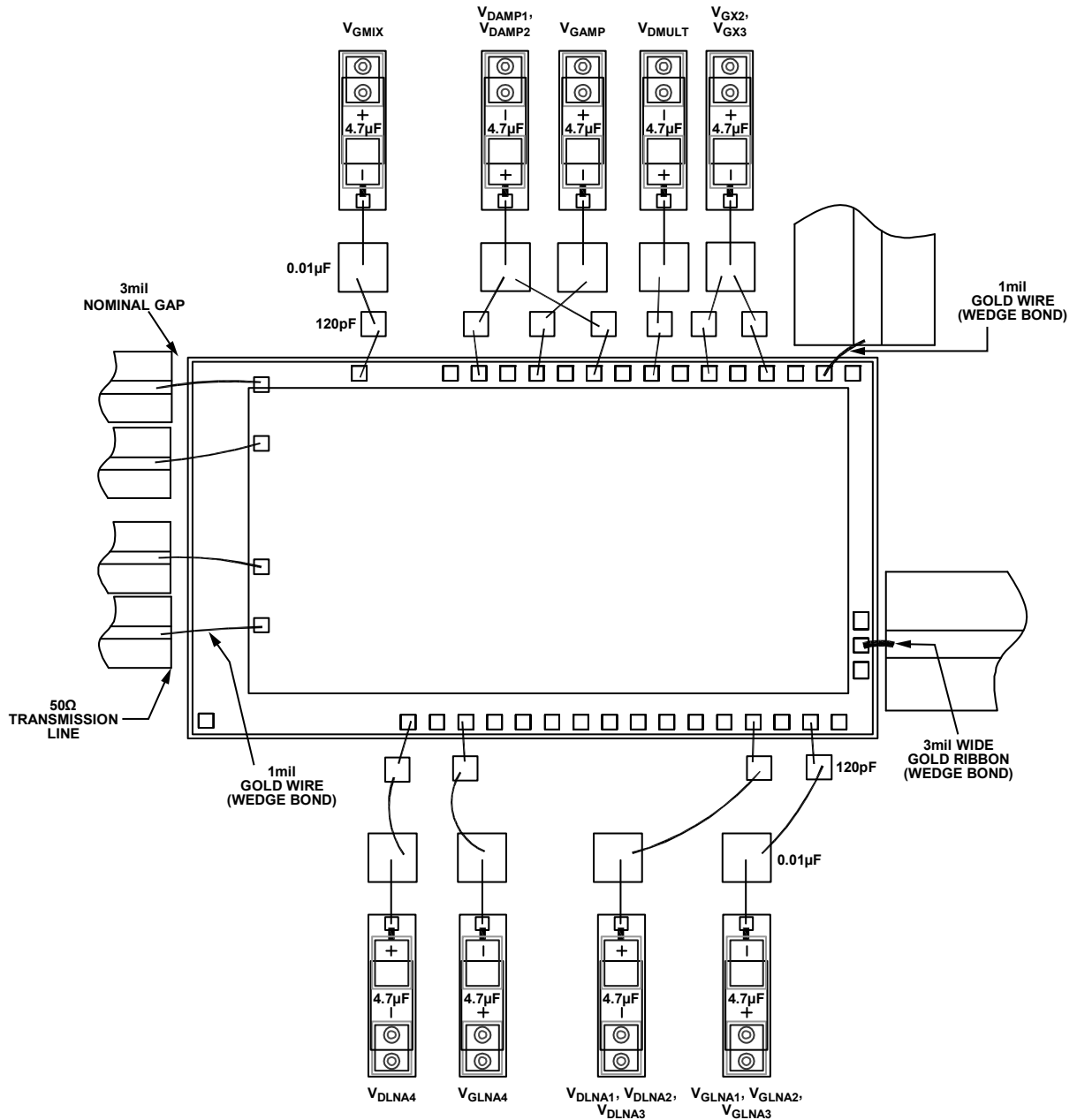

Figure 213. Assembly Diagram

13126-234

MOUNTING AND BONDING TECHNIQUES FOR MILLIMETERWAVE GaAs MMICS

Attach the die directly to the ground plane eutectically or with conductive epoxy.

To bring RF to and from the chip, use 50 Ω microstrip transmission lines on 0.127 mm (5 mil) thick alumina thin film substrates (see Figure 214).

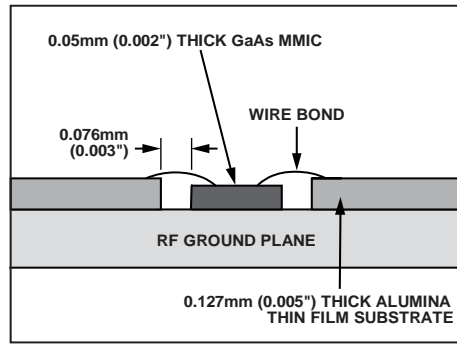

Figure 214. Routing RF Signals

To minimize bond wire length, place microstrip substrates as close to the die as possible. Typical die to substrate spacing is 0.076 mm to 0.152 mm (3 mil to 6 mil).

HANDLING PRECAUTIONS

To avoid permanent damage, adhere to the following precautions.

Storage

All bare die ship in either waffle or gel-based ESD protective containers, sealed in an ESD protective bag. After opening the sealed ESD protective bag, store all die a dry nitrogen environment.

Cleanliness

Handle the chips in a clean environment. Never use liquid cleaning systems to clean the chip.

Static Sensitivity

Follow ESD precautions to protect against ESD strikes that are greater than 100 V.

Transients

Suppress instrument and bias supply transients while bias is applied. To minimize inductive pickup, use shielded signal and bias cables.

General Handling

Handle the chip on the edges only using a vacuum collet or with a sharp pair of bent tweezers. Because the surface of the chip has fragile air bridges, never touch the surface of the chip with a vacuum collet, tweezers, or fingers.

MOUNTING

The chip is back metallized and can be die mounted with gold/tin (AuSn) eutectic preforms or with electrically conductive epoxy. The mounting surface must be clean and flat.

Eutectic Die Attach

It is best to use an 80%/20% gold tin preform with a work surface temperature of 255°C and a tool temperature of 265°C. When hot 90%/10% nitrogen/hydrogen gas is applied, maintain tool tip temperature at 290°C. Do not expose the chip to a temperature greater than 320°C for more than 20 sec. No more than 3 sec of scrubbing is required for attachment.

Epoxy Die Attach

ABLEBOND 84-1LMIT is recommended for die attachment. Apply a minimum amount of epoxy to the mounting surface so that upon placing it into position, a thin epoxy fillet is observed around the perimeter of the chip. Cure epoxy per the schedule provided by the manufacturer.

WIRE BONDING

RF bonds made with 3 mil (0.0762 mm) \times 0.5 mil (0.0127 mm) gold ribbon are recommended for RF port and wedge bonds with 1 mil (0.0254 mm) diameter gold wire are recommended for IF and LO ports. Thermosonically bond these bonds with a force of 40 g to 60 g. DC bonds of 1 mil (0.0254 mm) diameter, thermosonically bonded, are recommended. Create ball bonds with a force of 40 g to 50 g and wedge bonds with a force of 18 g to 22 g. Create all bonds with a nominal stage temperature of 150°C. Apply a minimum amount of ultrasonic energy to achieve reliable bonds. Keep all bonds as short as possible, less than 12 mil (0.31 mm).

OUTLINE DIMENSIONS

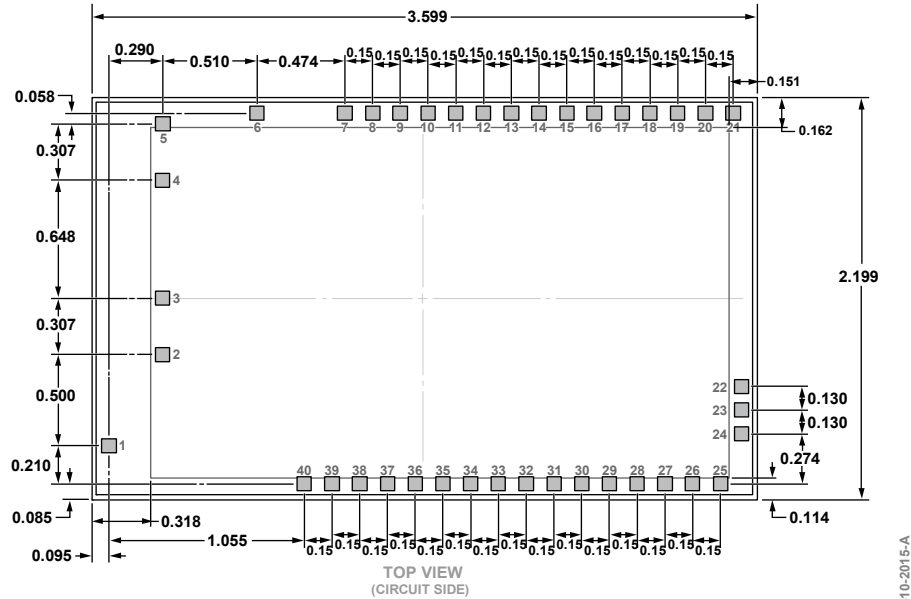

Figure 215. 40-Pad Bare Die [CHIP]
(C-40-1)
Dimensions shown in millimeters

ORDERING GUIDE

Model ¹	Temperature Range	Package Description	Package Option ²
HMC7586	-55°C to +85°C	40-Pad Bare Die [CHIP]	C-40-1
HMC7586-SX	-55°C to +85°C	40-Pad Bare Die [CHIP]	C-40-1

¹ The HMC7586-SX consists of two pairs of the die in a gel pack for sample orders.

² This is a waffle pack option; contact Analog Devices, Inc. for additional packaging options.