

User's Manual

ELI101-IPHW



ELI101-IPHW

Revision 1.01

FDI *Future Designs, Inc.*
Your Development Partner
996 A Cleaner Way, Huntsville, AL 35805

Important Legal Information

Information in this document is provided solely to enable the use of Future Designs, Inc. (FDI) products. FDI assumes no liability whatsoever, including infringement of any patent or copyright. FDI reserves the right to make changes to these specifications at any time, without notice. No part of this document may be reproduced or transmitted in any form or by any means, electronic or mechanical, for any purpose, without the express written permission of Future Designs, Inc. 996 A Cleaner Way, Huntsville, AL 35805.

Microsoft, MS-DOS, Windows, Windows XP, Microsoft Word are registered trademarks of Microsoft Corporation. Other brand names are trademarks or registered trademarks of their respective owners.

Printed in the United States of America.

For more information on FDI or our products please visit www.TeamFDI.com.

©2018 Future Designs, Inc. All rights reserved.

FDI Document PN: MA00086

Revision: 1.01, 6/07/2018



Important Legal Information	2
1.0 Introduction	4
2.0 Box Contents	4
3.0 Optional Accessories Recommended for Use (Purchased Separately)	4
4.0 ESD Warning	5
5.0 Determining the Revision of your ELI.....	5
6.0 Technical Specifications	6
7.0 Connectors.....	7
8.0 Power Details	7
9.0 Extended Display Information Data (EDID)	9
10.0 Brightness Control.....	9
11.0 PWM Control of Backlight	9
12.0 Support	15
12.1 Where to Get Help.....	15
12.2 Useful Links	15



1.0 Introduction

About ELI (the Easy LCD Interface)

ELI® is Future Designs, Inc.'s family of long-life, plug-and-play embedded displays. ELI products are true modular embedded display solutions that require no engineering or lead-time. All ELI products are compatible with a wide range of single board computers including Raspberry Pi, BeagleBone Black and Windows-based units. FDI designed ELI as an embedded display option that requires minimal development time to help customers reach production quickly. Once a product is in production, FDI's 10-15 year ELI product availability guarantee helps ensure production schedules without the risk of expensive or time consuming redesigns. Learn more about ELI at TeamFDI.com/ELI.

ELI Compatibility

ELI products are compatible with most single board computers, PCs and operating systems. See the compatibility tab at <https://www.teamfdi.com/product-details/eli101-iphw> for the results of FDI's compatibility tests with popular operating systems and platforms. Our results, as indicated in the table, demonstrate ELI's versatility but the table is not exhaustive. ELI products are designed to work with any single board computer that has an HDMI or DVI output. To submit a question about ELI's compatibility with a platform or operating system that is not included in the table, contact a member of the FDI support team at Support@teamfdi.com.

Your ELI Experience

Share your experience connecting ELI devices to various (single board) computers at: <http://www.teamfdi.com/edid/#edidform>.

2.0 Box Contents

- ELI101-IPHW

3.0 Optional Accessories Recommended for Use (Purchased Separately)

- 12V DC +/-5% 2A Power Supply with a center positive barrel plug
 - 2.1mm I.D. x 5.5mm O.D. x 9.5mm
 - All ELI units operate from +12V DC so this is the recommended power supply input voltage for the entire Family.
- USB Type A to Mini Type B Cable (For touch)
- HDMI Cable (Type A Male)



4.0 ESD Warning



Figure 1. Electrostatic Sensitive Device

Our ELI units are shipped in a protective anti-static package. Do not subject the module to high electrostatic potentials. Exposure to high electrostatic potentials may cause damage to the boards that will not be covered under warranty. General practice for working with static sensitive devices should be followed when working with this device.

5.0 Determining the Revision of your ELI

All ELI devices have a label placed on the board to identify the part number and revision of the unit. This label will help you quickly and correctly identify your ELI unit's part number and revision number. An example of an ELI label is shown below.



6.0 Technical Specifications

Table 1. Technical Specifications

Screen Size:	10.1 inches (diagonal)
Display Technology:	IPS a-Si TFT LCD
Resolution:	1280 x 800 (WXGA)
Brightness:	690 nits (typical)
Contrast Ratio:	800:1 (typ)
Aspect Ratio:	16:9
Interface Input Mode:	HDMI/DVI
Colors:	16.7M (24 bit)
Horizontal Viewing Angle:	85/85° L/R
Vertical Viewing Angle:	85/85° U/D
Surface:	1.1mm chemically strengthened Steel Glass
Touch Screen:	Projected Capacitive
Touch Screen Interface:	USB
Touch Panel Hardness:	>7H
Touch Panel Force:	N/A
Active Area:	216.96 (W) x 135.60 (H) mm
Response Time:	10 Ton, 15 Toff ms
Backlight:	45 LED
Backlight Life:	50K hours (typ)
Backlight Power Consumption:	2.88 W (typ)
Operating Temperature:	-20° to 70° C
Storage Temperature:	-30° to 80° C
Input Voltage:	+5 to +24 VDC \pm 5%
Power Consumption:	900 (typ) / 1100mA (max) @12V
RoHS Compliant:	Yes
Dimensions:	251.2 (W) x 161.6 (H) x 19.0 (D) mm
Mounting:	3M 300LSE tape or other 3M tape
Weight:	380 grams



7.0 Connectors

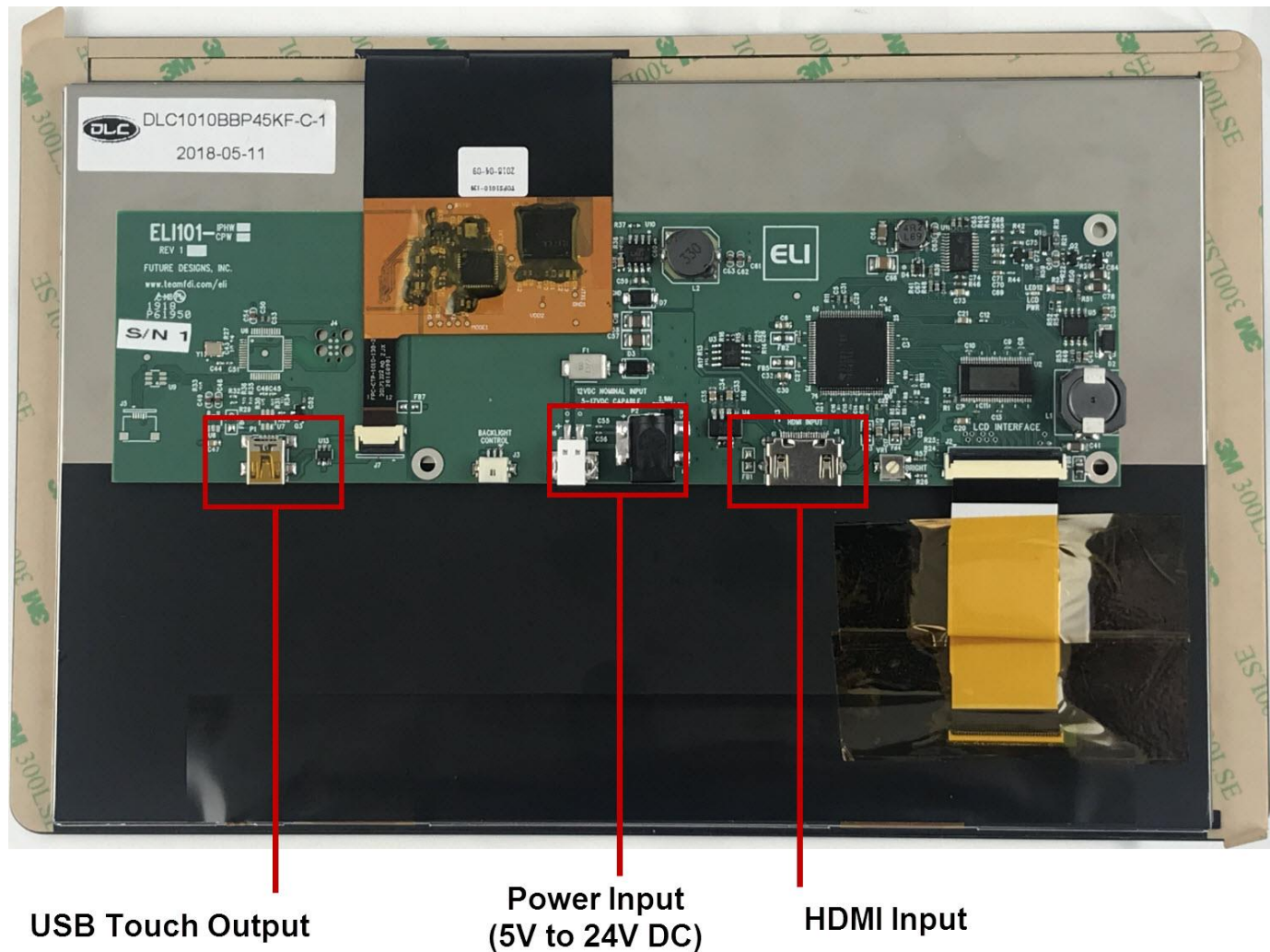

Figure 2. ELI101-IPHW Connectors

8.0 Power Details

A 12VDC \pm 5% power supply with a 2.0A output will power any board from the ELI Family. This allows a common, off-the-shelf power supply such as the [T1071-P5P-ND](#) to be used for quick demos or prototyping across the entire ELI Family. In general, any 12VDC power supply with a 2.1mm center positive plug will be acceptable if it can provide enough current to power the particular ELI unit being used. On the ELI101-IPHW plug power into the (P2) connector.

The ELI101-IPHW input power range is expanded to include +5 to 24V DC \pm 5% (2.0A) for greater design flexibility.



For volume production applications, the input power can be optimized for your ELI unit and lower capacity power supplies can be used.

In cases where the barrel connector is not desired, you can use the alternate power input connector (J6) which supports directly plugging in 20-26 AWG wire with maximum 5A current per contact. The datasheet for this J6 connector (PCB terminal block - PTSM 0,5/ 2-2,5-H SMD WH R24 – 1814634) can be found at <http://tinyurl.com/1814634>.

To verify that the ELI101-IPHW unit is correctly powered you may check the 12VDC input with a Fluke meter or scope by probing the +12V and GND contacts shown below. Please verify that the 12VDC is present, is within the +/- 5% tolerance and is free from excessive noise or AC ripple.

Note: If using an input that is within the acceptable range of +5VDC to +24VDC (+/- 5%), please keep in mind that the 12V Test points should be at the voltage of your chosen power supply (5-24VDC).

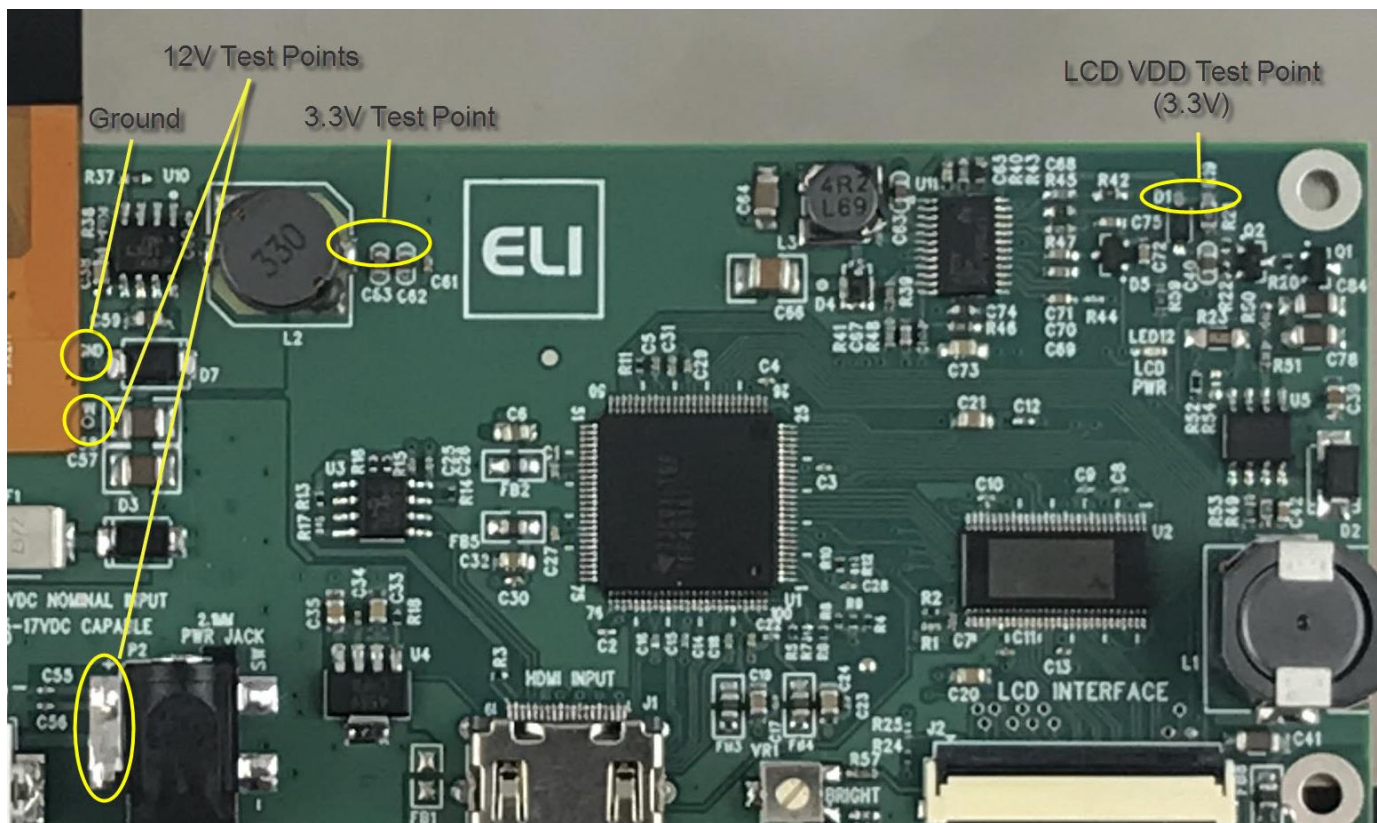

Figure 3. ELI101-IPHW Power Test Points

9.0 Extended Display Information Data (EDID)

ELI uses Extended Display Identification Data (EDID) for automatic configuration with many operating systems. You can find out more on our website at <http://www.teamfdi.com/edid/>.

10.0 Brightness Control

ELI101-IPHW contains a Brightness Control potentiometer (VR1) on the backside of the board, see Figure 4. Using this pot, you can set the default “Factory” brightness of the LCD Backlight. Turning the pot fully clockwise results in maximum brightness of the display. Turning the pot counter-clockwise will turn the backlight off.

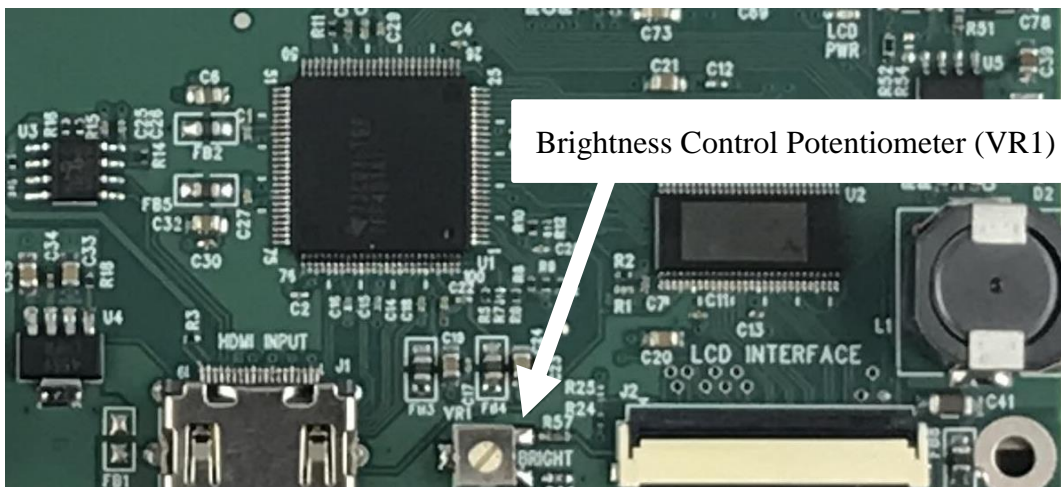

Figure 4. Brightness Control Potentiometer (VR1).

11.0 PWM Control of Backlight

ELI provides an input for an external processor to control the brightness of the display backlight, see Figure 5. Controlling the backlight also controls ELI power consumption (the display backlight is typically one of the larger sources of power consumption in the system). PWM dimming is an input with a 0 to 3.3 VDC range and the user should drive this with a push-pull type output or a suitable open collector output.

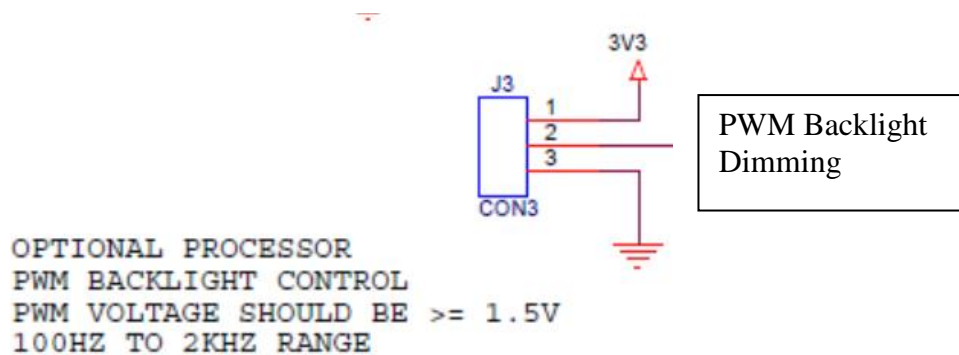

Figure 5. Backlight Control

To control the display backlight, the user should connect an externally generated Pulse Width Modulated (PWM) signal to J3 pin 2 along with a common ground to J3 pin 3. The frequency range for this signal is from 100Hz to 2KHz. Each ELI's backlight properties vary, so the user should test their version for an acceptable range of brightness control. Your 0 to 100% brightness range may be 40% to 90% of the PWM range. In certain installations, a series resistor may be required to ensure a clean PWM signal to the ELI. The suggested value for the resistor is 100ohms. See Figure 7 below, for example of connectivity. Actual testing in your installation may require this resistor to be changed, or possibly not required at all.

On the ELI unit, the PWM dimming signal is pulled up between 1.49V and 0.487 volts. This is controlled by the Linear Brightness Control Potentiometer (VR1), detailed in Paragraph 10.0.

If you provide NO PWM signal to VLED_PWM (J3 pin 2), ELI will provide 100% backlight power to the display (default potentiometer setting). The potentiometer setting can be overdriven by the push-pull PWM input on J3-2, so the external SBC can always maintain control of the backlight brightness across the full range. The potentiometer can be used to set a default backlight brightness level that is used until the SBC has time to boot up and set the desired brightness level via PWM output. This feature can also be used to “blank” the display during boot-up in cases where the default BIOS settings aren't compatible with ELI. This prevents the screen from showing incorrect images until the SBC has time to boot and read EDID or set the correct video timings for the ELI101-IPHW.

The output at pin 1 of J3 is 3.3VDC $\pm 5\%$. If the external system is capable of directly driving the PWM dimming signal at 3.3VDC, there is no need to connect pin 1 to the cable. ELI provides the 3.3 VDC signal for the external system in case this voltage is needed to generate the correct levels on the PWM VLED_PWM Input.



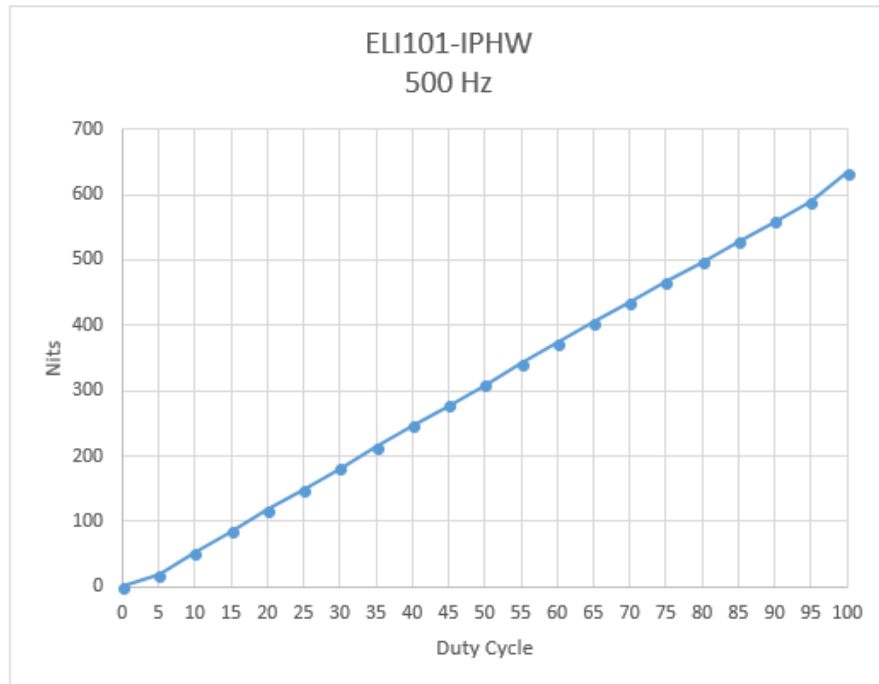

Figure 6. ELI101-IPHW Backlight Curve in Nits

Note: Pot VR1 has no effect while PWM signal is applied.

The J3 mating connector information:

- Manufacturer: Hirose
- Part Number: DF12-3S-1.25C
- Digi-Key Link: <https://www.digikey.com/products/en?keywords=H2180-ND>
- Pre-terminated wires <https://www.digikey.com/products/en?PPV=1811-9-566967>

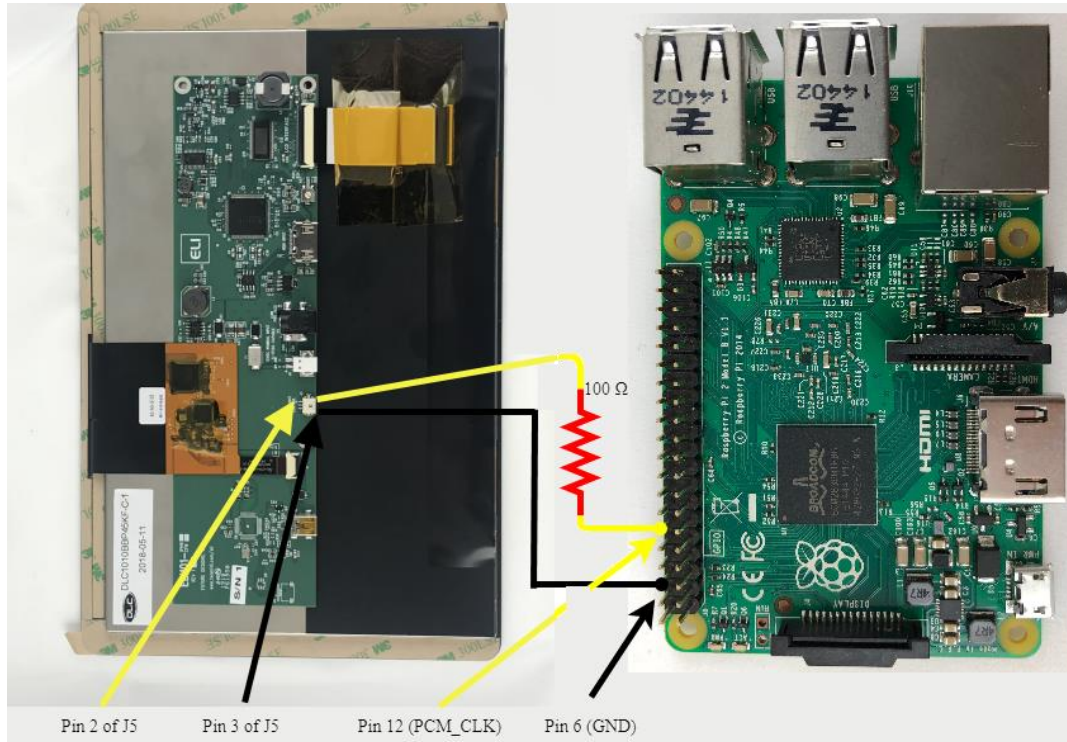

Figure 7. Raspberry Pi Signal and Ground

The ELI backlight can be controlled from a Raspberry Pi. See Figure 7 for a wiring diagram. Our software is available on the FDI website at <https://www.teamfdi.com/product-details/eli101-iphw#software> or you may copy the code from here:

```

/* Changes brightness of ELI backlight given a command line argument between 0 and
the set range. Uses bcm2835 header file provided by Broadcom at
http://www.airspayce.com/mikem/bcm2835/bcm2835-1.52.tar.gz This source code must be
compiled using "g++ brightness.cpp -o brightness -l bcm2835" in order to properly
link the header file. Must be run using sudo, accessing GPIO pins requires root
permissions. After compiling, you may add executable to "/usr/bin" which allows you
to type "sudo brightness <value>" to change brightness anywhere in terminal. The
"/boot/config.txt" file must also be changed by adding a "#" before the line
"dtparam=audio=on". This disables audio output from the Raspberry Pi. If this is
not disabled then anytime sound is output the screen will return to 100%
brightness.
*/

```

```

#include<iostream>
#include<bcm2835.h>
#include<string>

using namespace std;

#define LED RPI_GPIO_P1_12 // PWM pin number for backlight control
#define RANGE 20 // Range for PWM steps
#define CLOCK 1920 // Clock rate

int main(int argc, char *argv[]){

    int data = 0; // Brightness level

    if(argc != 2){ // Give user correct usage if ran incorrectly
        cout << "Error: correct usage, brightness <value>" << endl;
        return 1;
    }

    data = stoi(argv[1]);

    if(data > RANGE || data < 0){
        cout << "Error: brightness value must be between 0 and " << RANGE << endl;
        return 1;
    }

    if(!bcm2835_init())
        return 1;

    bcm2835_gpio_set_pad(BCM2835_PAD_GROUP_GPIO_0_27, BCM2835_PAD_DRIVE_2mA); //
Sets the drive current to 2mA
    bcm2835_gpio_fsel(LED, BCM2835_GPIO_FSEL_ALT5); // Sets up pin 18 for alt5 pwm
mode

    bcm2835_pwm_set_clock(CLOCK); // Sets pwm clock to 19.2 MHz / CLOCK
    bcm2835_pwm_set_mode(0,1,1); // Sets mode to markspace
    bcm2835_pwm_set_range(0,RANGE); // Sets range
    bcm2835_pwm_set_data(0,data); // Sets data rate to argument value

    bcm2835_close();
    return 0;
}

```

Figure 8. Backlight Control Using Raspberry Pi

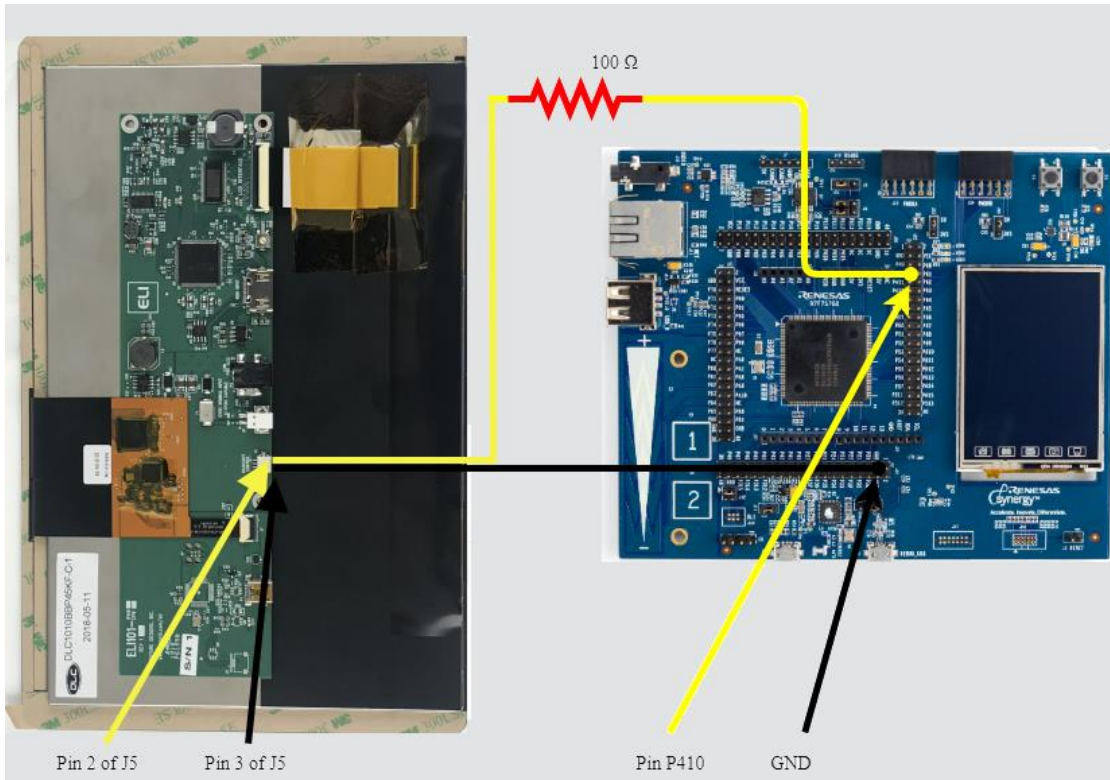

Figure 9. Renesas Synergy S7G2 Signal and Ground

Another example of backlight control using a microcontroller is Renesas Synergy S7G2 wired as shown in Figure 9. The software for Synergy can be found on our website at <https://www.teamfdi.com/product-details/eli70-iphw#software>.

12.0 Support

12.1 Where to Get Help

Online technical support is available at <http://www.teamfdi.com/support/>

12.2 Useful Links

- Future Designs, Inc. Forums: <http://www.teamfdi.com/forum>
- ELI101-IPHW Product Page: <http://www.teamfdi.com/product-details/eli101-iphw>
- ELI Software User's Manual: <http://www.teamfdi.com/wp-content/uploads/ELI-Software-Users-Manual.pdf>
- Tell us about your ELI experience: <http://www.teamfdi.com/edid/#edidform>
- EDID Information Page: <http://www.teamfdi.com/edid/>

