



**SERIES:** HSE-18X | **DESCRIPTION:** HEAT SINK

**FEATURES**

- TO-218 package
- placement pins for secure PCB attachment
- round hole for component attachment
- multiple available cut lengths



**MODEL**

	length (mm)	thermal resistance <sup>1</sup>				power dissipation <sup>1</sup> @ 75°C ΔT, nat conv (W)
		@ 75°C ΔT, nat conv (°C/W)	@ 1 W, nat conv (°C/W)	@ 1 W, 200 LFM (°C/W)	@ 1 W, 400 LFM (°C/W)	
HSE-B18254-0396H	25.4	9.15	11.15	2.29	2.07	8.20
HSE-B18318-0396H	31.8	8.24	9.93	2.57	1.80	9.10
HSE-B18381-0396H	38.1	6.94	8.71	2.29	1.80	10.80
HSE-B18508-0396H	50.8	5.86	7.62	2.45	1.79	12.80
HSE-B18635-0396H	63.5	5.47	7.36	2.78	1.55	13.70

Note: 1. See performance curves for full thermal resistance details.  
2. Custom cut to length options available. Thermal data not available on custom lengths.

**PERFORMANCE CURVES**

**HSE-B18254-0396H**

Power (W)	Heatsink Temperature Rise Above Ambient (ΔT = T <sub>hs</sub> - T <sub>a</sub> ) (°C)		
	Natural Conv.	200 LFM	400 LFM
0	0	0	0
1	11.15	2.29	2.07
2	20.39	4.95	4.07
3	30.47	7.76	6.21
4	38.70	11.00	8.23
5	48.05	13.96	10.29
6	57.30	16.92	12.55
7	66.12	19.68	14.54
8	73.21	22.63	16.48
9	80.86	25.48	18.68
10	88.12	28.22	20.84

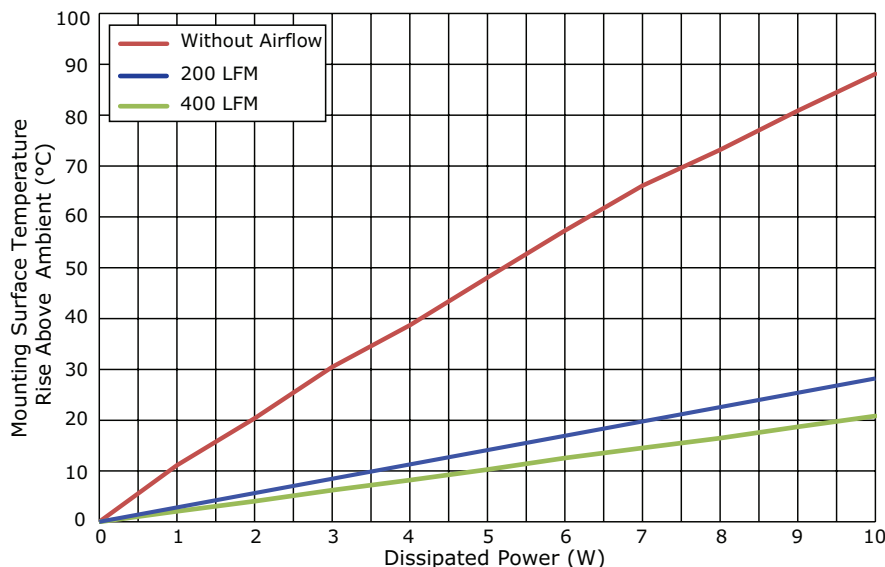

T<sub>hs</sub>: "hot spot" temperature measured on the heatsink  
T<sub>a</sub>: ambient temperature

## PERFORMANCE CURVES (CONTINUED)

### HSE-B18318-0396H

Power (W)	Heatsink Temperature Rise Above Ambient ( $\Delta T = T_{hs} - T_a$ ) (°C)		
	Natural Conv.	200 LFM	400 LFM
0	0	0	0
1	9.93	2.57	1.80
2	19.55	5.41	3.67
3	28.10	8.10	5.47
4	36.39	10.89	7.40
5	44.29	13.77	9.45
6	51.91	16.50	11.49
7	59.92	19.29	13.27
8	67.55	22.14	15.22
9	74.45	24.97	17.22
10	81.01	27.92	19.08

$T_{hs}$ : "hot spot" temperature measured on the heatsink  
 $T_a$ : ambient temperature

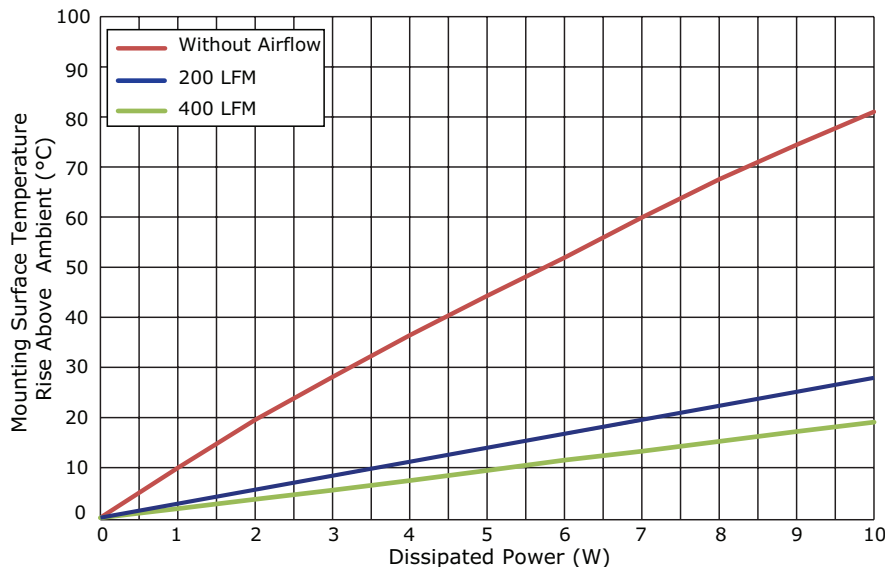

### HSE-B18381-0396H

Power (W)	Heatsink Temperature Rise Above Ambient ( $\Delta T = T_{hs} - T_a$ ) (°C)		
	Natural Conv.	200 LFM	400 LFM
0	0	0	0
1	8.71	2.29	1.80
2	17.51	4.67	3.45
3	25.16	6.92	5.27
4	31.88	9.51	6.96
5	38.73	11.93	9.00
6	45.88	14.31	10.31
7	52.16	16.91	12.03
8	57.90	19.57	13.87
9	64.39	22.26	15.35
10	70.70	24.56	17.34
11	76.71	27.23	18.94
12	82.68	30.24	20.62
13	88.72	32.89	22.43
14	92.86	35.95	24.08
15	98.52	38.57	25.96

$T_{hs}$ : "hot spot" temperature measured on the heatsink  
 $T_a$ : ambient temperature

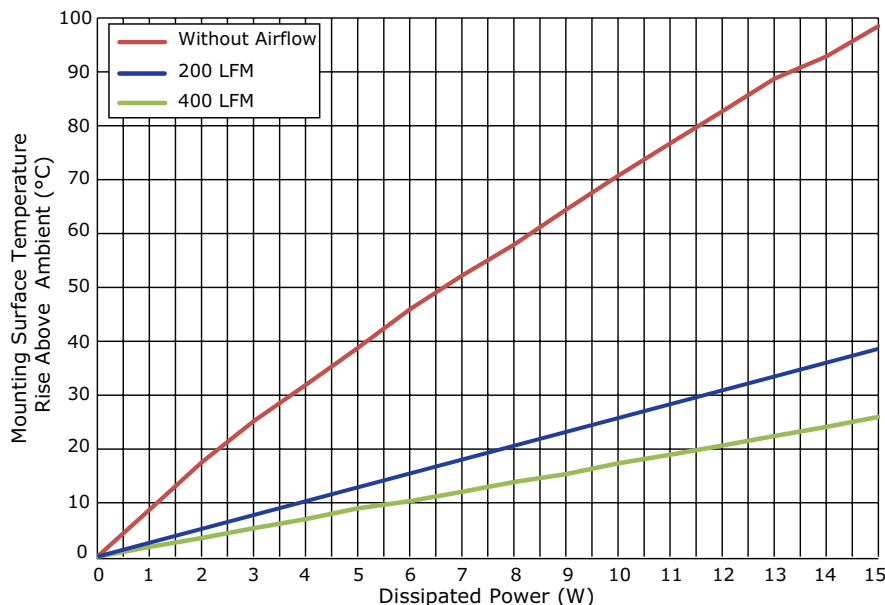

## PERFORMANCE CURVES (CONTINUED)

### HSE-B18508-0396H

Power (W)	Heatsink Temperature Rise Above Ambient ( $\Delta T = T_{hs} - T_a$ ) (°C)		
	Natural Conv.	200 LFM	400 LFM
0	0	0	0
1	7.62	2.45	1.79
2	14.75	5.07	3.78
3	21.30	7.93	5.77
4	27.29	10.95	7.77
5	33.00	13.97	9.65
6	39.34	16.78	11.13
7	45.69	19.80	13.41
8	51.39	22.76	15.66
9	56.70	25.71	17.63
10	61.04	28.78	19.70
11	66.55	31.89	21.71
12	71.51	34.70	23.68
13	76.66	37.87	25.70
14	81.16	40.44	27.66
15	85.69	43.56	29.84

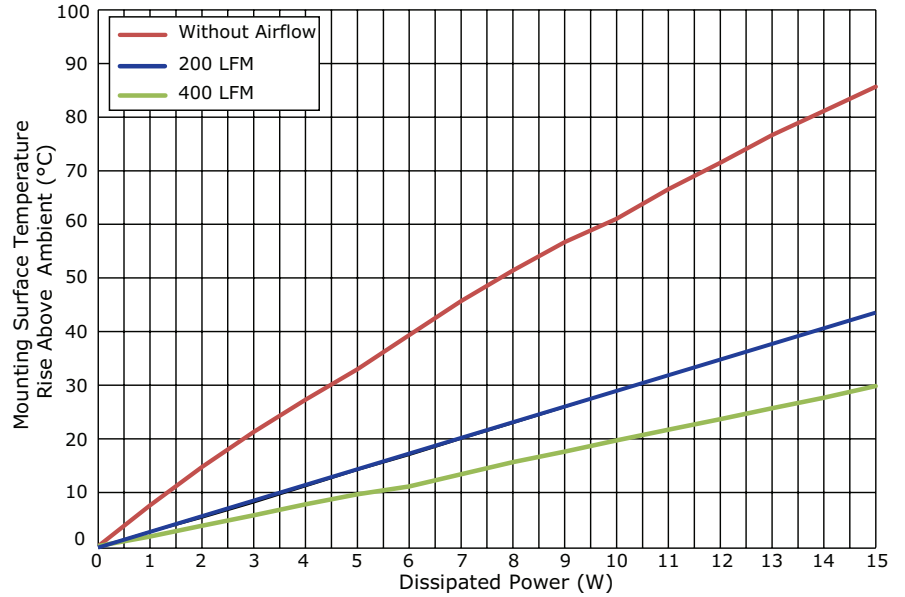

T<sub>hs</sub>: "hot spot" temperature measured on the heatsink  
 T<sub>a</sub>: ambient temperature

## PERFORMANCE CURVES (CONTINUED)

### HSE-B18635-0396H

Power (W)	Heatsink Temperature Rise Above Ambient ( $\Delta T = T_{hs} - T_a$ ) (°C)		
	Natural Conv.	200 LFM	400 LFM
0	0	0	0
1	7.36	2.78	1.55
2	14.26	5.51	3.34
3	20.72	8.49	5.38
4	26.71	11.30	7.58
5	32.32	13.90	9.50
6	37.95	17.05	11.58
7	43.27	19.88	13.58
8	48.53	22.56	15.55
9	53.62	25.41	17.59
10	58.48	28.50	19.59
11	63.26	30.79	21.43
12	67.93	33.63	23.37
13	72.42	36.30	25.31
14	76.58	39.06	27.34
15	81.06	42.34	29.38

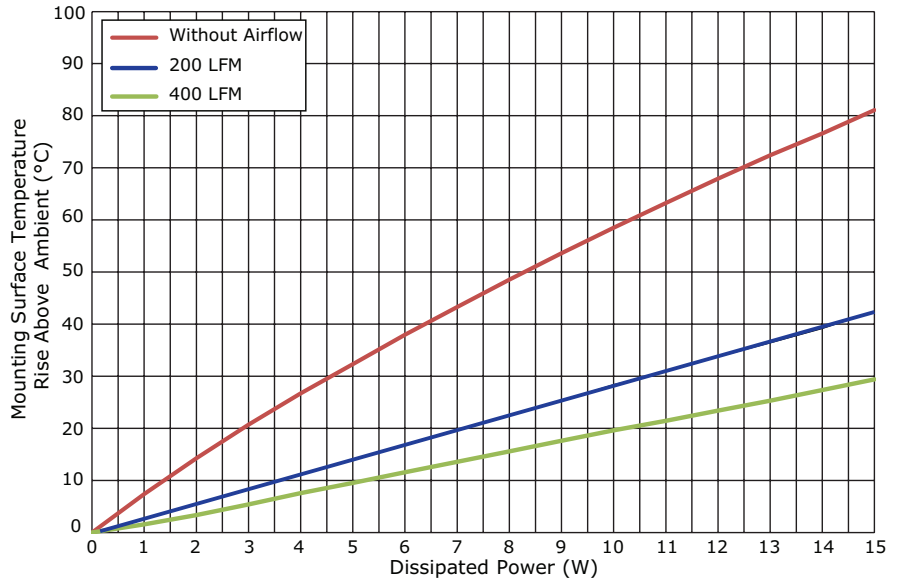

T<sub>hs</sub>: "hot spot" temperature measured on the heatsink  
 T<sub>a</sub>: ambient temperature

## MECHANICAL DRAWING

units: mm  
tolerance: ±0.5 mm

MATERIAL	AL 6063-T5
FINISH	black anodized
PIN MATERIAL	steel
PIN PLATING	tin

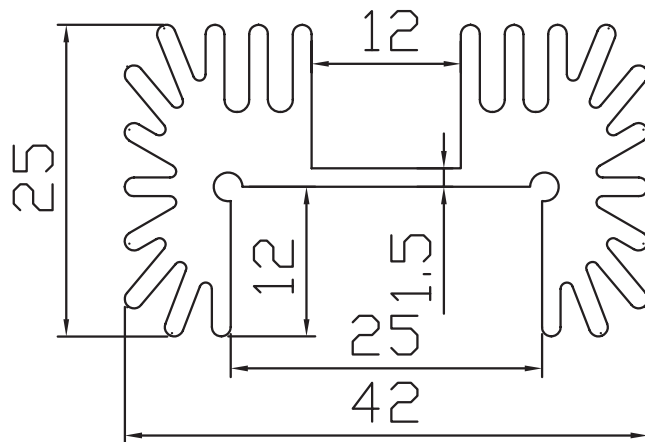
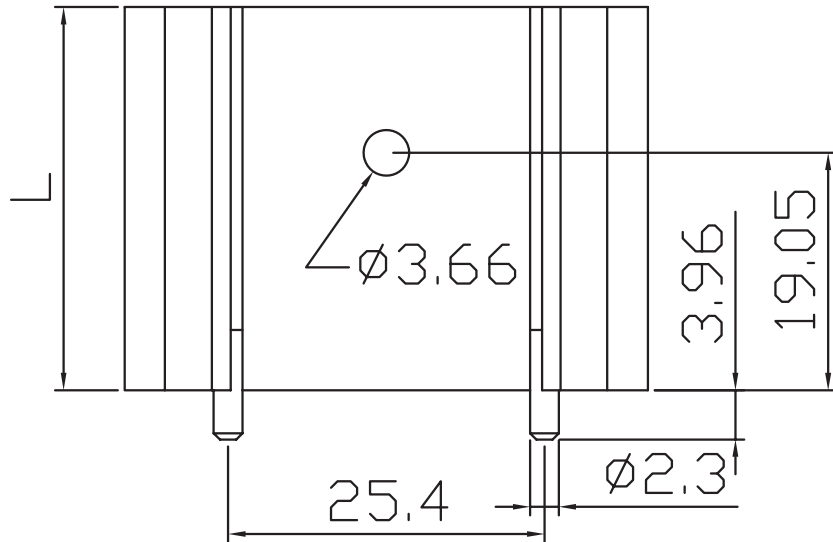

MODEL NO.	LENGTH, L (mm)	WEIGHT (g)
HSE-B18254-0396H	25.4	30
HSE-B18318-0396H	31.8	43
HSE-B18381-0396H	38.1	44
HSE-B18508-0396H	50.8	57
HSE-B18635-0396H	63.5	69

## REVISION HISTORY

---

rev.	description	date
1.0	initial release	05/11/2017

The revision history provided is for informational purposes only and is believed to be accurate.

**CUI INC**<sup>®</sup>

**Headquarters**  
20050 SW 112th Ave.  
Tualatin, OR 97062  
**800.275.4899**

Fax 503.612.2383  
**cui.com**  
techsupport@cui.com

CUI offers a one (1) year limited warranty. Complete warranty information is listed on our website.

CUI reserves the right to make changes to the product at any time without notice. Information provided by CUI is believed to be accurate and reliable. However, no responsibility is assumed by CUI for its use, nor for any infringements of patents or other rights of third parties which may result from its use.

CUI products are not authorized or warranted for use as critical components in equipment that requires an extremely high level of reliability. A critical component is any component of a life support device or system whose failure to perform can be reasonably expected to cause the failure of the life support device or system, or to affect its safety or effectiveness.