

THIS DOCUMENT IS THE PROPERTY OF
KEYSTONE ELECTRONICS CORP. AND
SHALL NOT BE REPRODUCED, DISTRIBUTED
OR USED AS A BASIS FOR MANUFACTURE
WITHOUT PRIOR WRITTEN PERMISSION
FROM KEYSTONE ELECTRONICS CORP.

**TOP TOOL
P/N 1715**

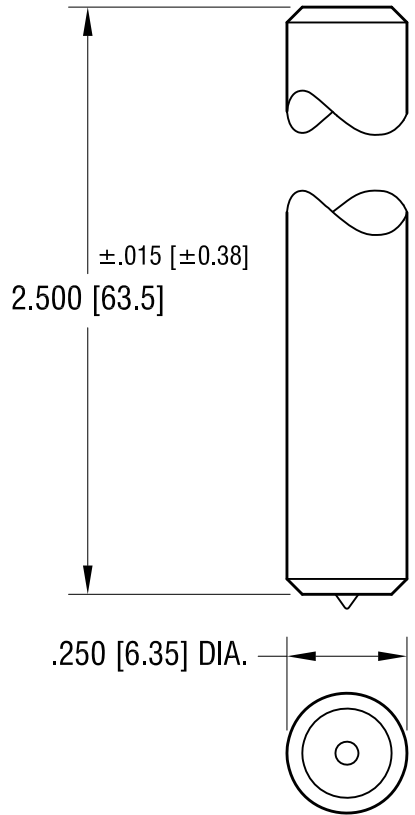

**BOTTOM TOOL
P/N 1717**

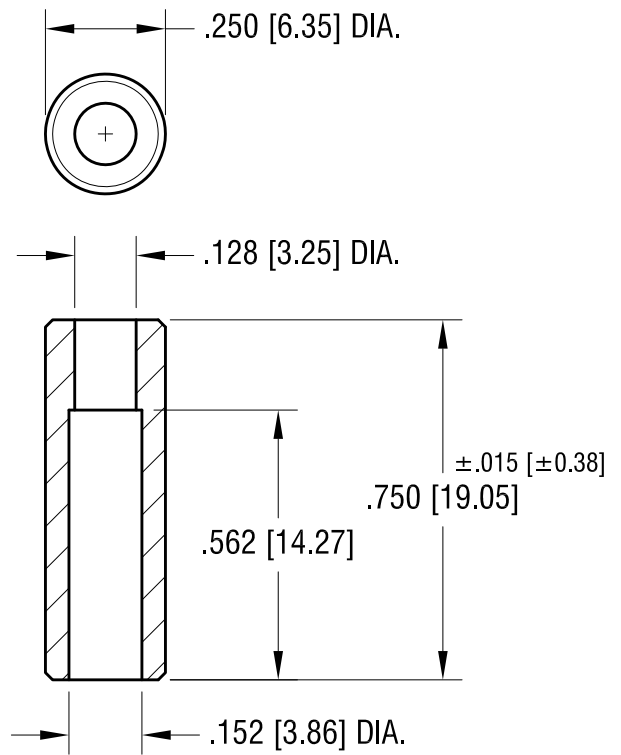

KEYSTONE ELECTRONICS CORP.

www.keyelco.com • ASTORIA, N.Y. 11105-2017 • Tel (718) 956-8900

PART NAME

SWAGE STAKING TOOL

MATERIAL

C.R.S.

FINISH

ZINC PLATE

DRN BY

BOONE

DATE

8.6.07

APP'D

LN

SCALE

2.5X

TOLERANCES

INCH [MM]

DECIMAL ±.005 [±0.13]

ANGULAR ± 1°
UNLESS OTHERWISE SPECIFIED

CODE

DWG NO.

C

TL-8

DATE

DESCRIPTION

REV.