

4

3

2

1

THIS DRAWING IS UNPUBLISHED. RELEASED FOR PUBLICATION 20
© COPYRIGHT 20 BY - ALL RIGHTS RESERVED.

REVISIONS

P	LTR	DESCRIPTION	DATE	DWN	APVD
A1		ECR-16-000601	14JAN2016	DW	CW
A2		ECR-16-007959	13JUN2016	RL	CW
A3		ECR-16-017508	13DEC2016	RL	CW
B		ECR-18-005861	03AUG2018	YC	CW

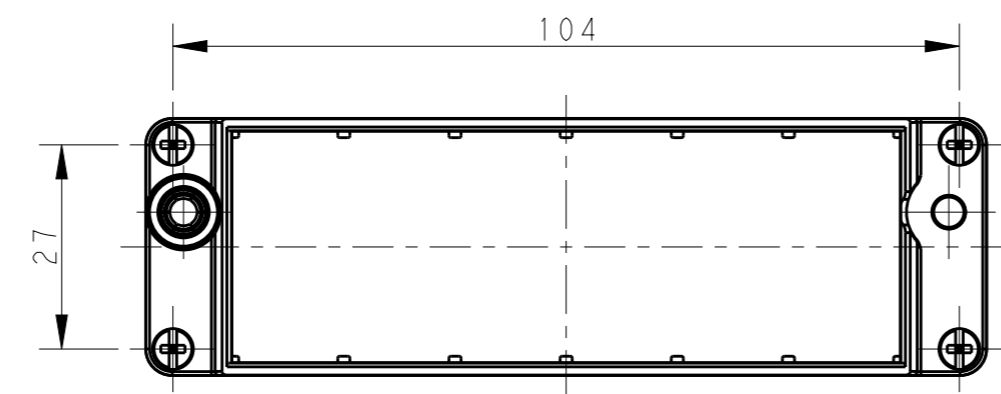
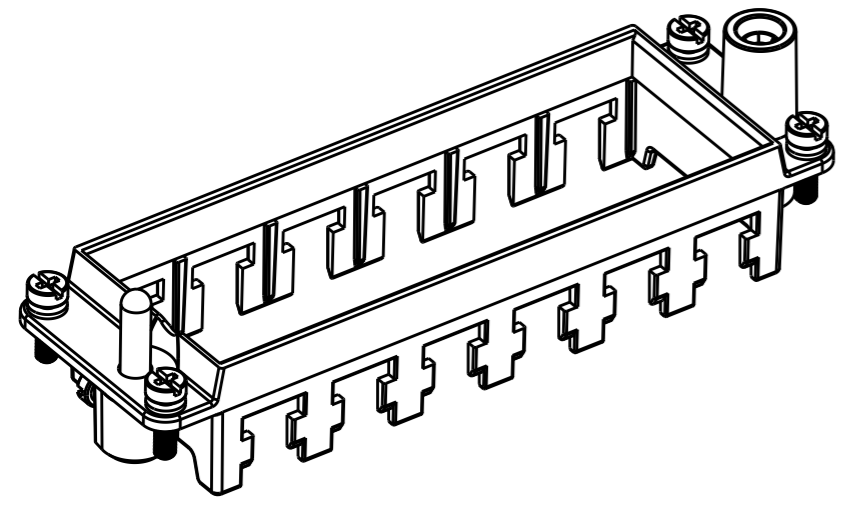

NOTES:
 1. TECHNICAL CHARACTERISTICS:
 FRAME MATERIAL: DIE CAST ZINC ALLOY
 NUMBER OF MODULES: 6
 SURFACE: ZINC PLATED
 MATING CYCLES: 500 CYCLES

注释:
 1. 技术参数:
 框架材料: 锌合金
 模块数量: 6
 表面处理: 镀锌
 插拔次数: 500次

4X M3 SCREW
 RECOMMENDED TIGHTENING TORQUE 0.5Nm
 4X M3 螺丝推荐锁紧力矩为0.5Nm

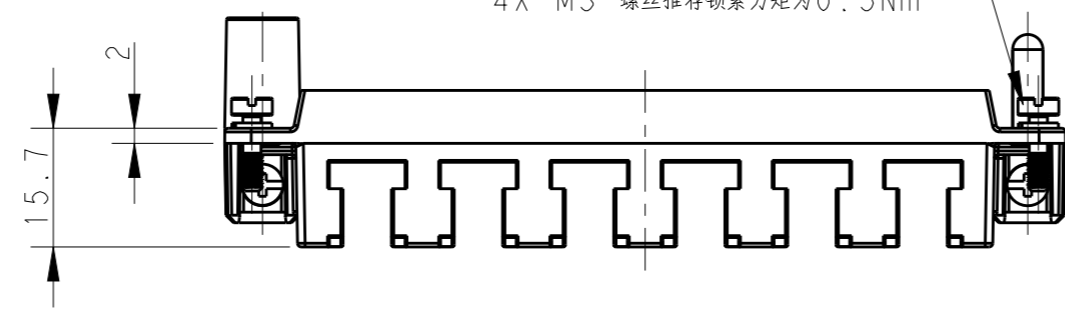
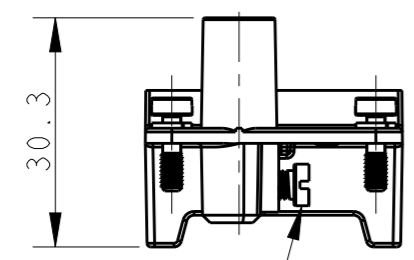

2X M4 SCREW, RECOMMENDED TIGHTENING TORQUE 1.2Nm
 2X M4 螺丝, 推荐锁紧力矩为1.2Nm

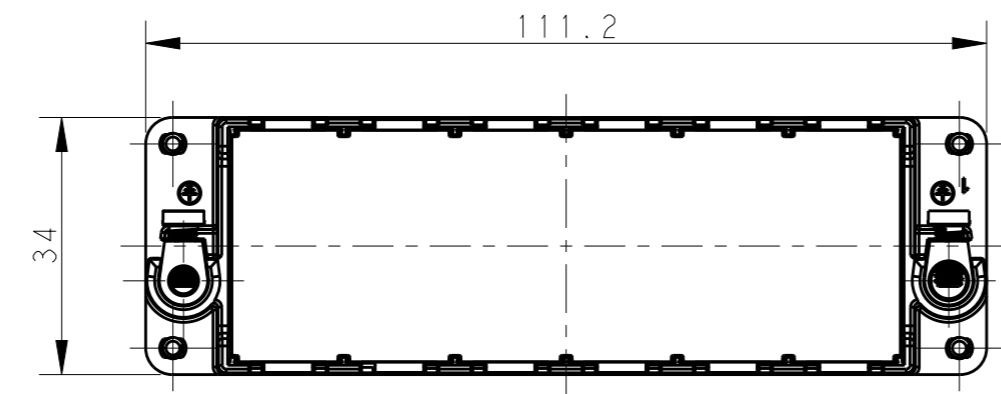

PANEL CUT FOR FRAME USE WITHOUT HOODS/ HOUSINGS

T2070244001-000 SHOWN ABOVE WITHOUT MARK
 T2070244001-000, 不带标记

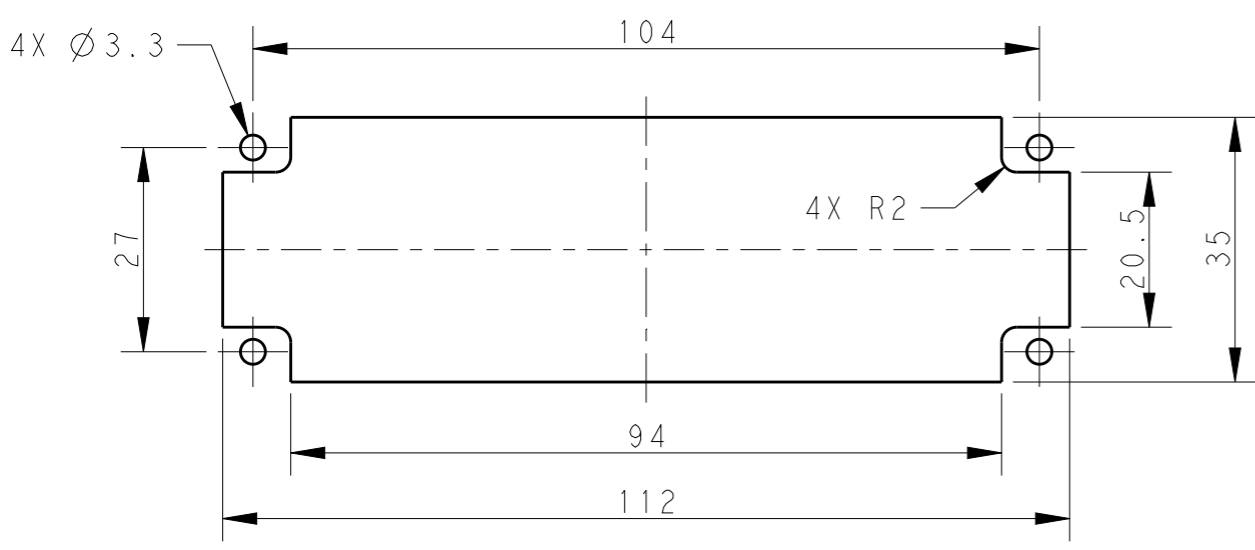

T2070244001-000	H24BN-T6	H24BN MODULE FRAME H24BN模块框架
T2070244101-000	H24BN-T6-M	H24BN MALE MODULE FRAME H24BN模块公框架
T2070244201-000	H24BN-T6-F	H24BN FEMALE MODULE FRAME H24BN模块母框架
T2070244101-001	H24BN-T6-M	H24BN MALE MODULE FRAME, MARK, NO LOGO H24BN模块公框架带标记, 不带LOGO
T2070244201-001	H24BN-T6-F	H24BN FEMALE MODULE FRAME, MARK, NO LOGO H24BN模块母框架带标记, 不带LOGO
PART NUMBER 料号		PART DESCRIPTION 描述

DIMENSIONS:		TOLERANCES UNLESS OTHERWISE SPECIFIED:	
mm			
0 PLC	±0		
1 PLC	±0.1		
2 PLC	±0.2		
3 PLC	±0.3		
4 PLC	±0.4		
ANGLES	±0.5		
MATERIAL		FINISH	
-		-	

DWN	28FEB2015
DAVID WANG	
CHK	28FEB2015
CHRIS WANG	
APVD	28FEB2015
XIANG XU	
PRODUCT SPEC	108-137057
APPLICATION SPEC	114-137057
WEIGHT	-
Customer Drawing	

		NAME	
		H24BN-T6	
SIZE	CAGE CODE	DRAWING NO	RESTRICTED TO
A3	-	©-T2070244001000	-
SCALE		SHEET	REV
1:1		1 OF 3	B

REVISIONS

P	LTR	DESCRIPTION	DATE	DWN	APVD
-	-	SEE SHEET 1	-	-	-

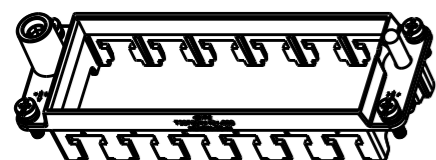

SCALE 1:2

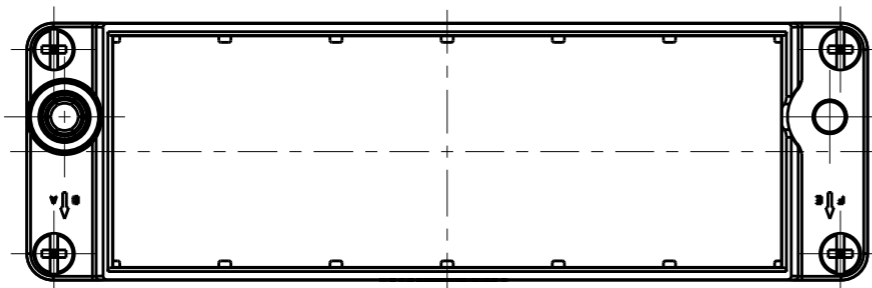

T2070244101-000, H24BN-T6-M SHOWN
 WITH MARK, ALL DIMENSIONS THE SAME TO T2070244001-000
 T2070244101-000, H24BN-T6-M, 带标记, 所有尺寸同T2070244001-000一样

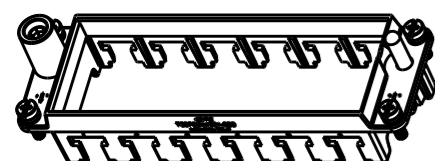
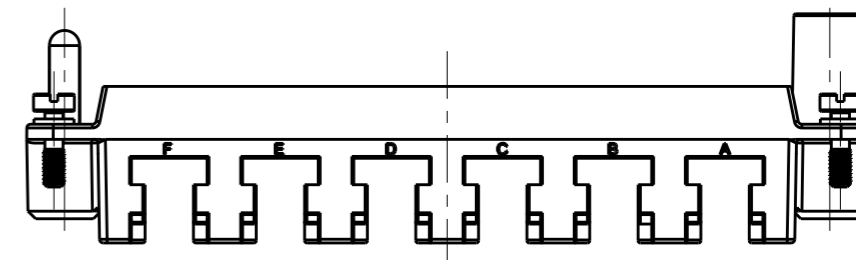
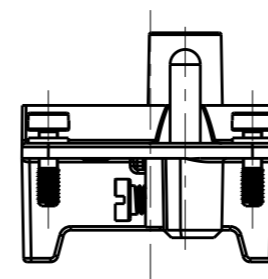
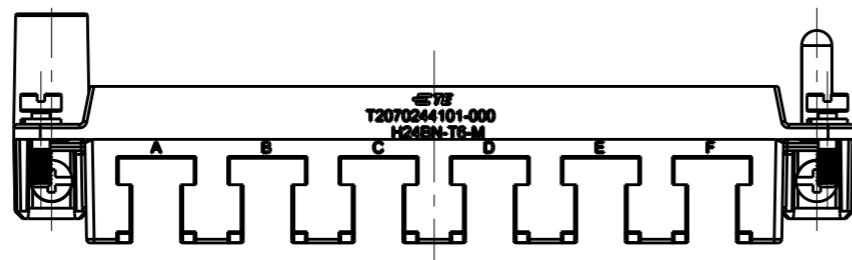

SCALE 1:2

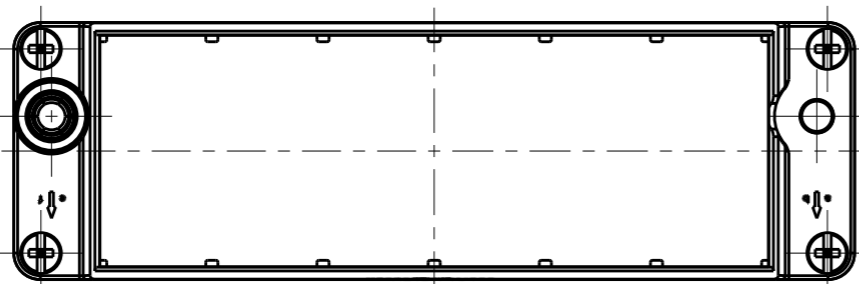

T2070244201-000, H24BN-T6-F SHOWN
 WITH MARK, ALL DIMENSIONS THE SAME TO T2070244001-000
 T2070244201-000, H24BN-T6-F, 带标记, 所有尺寸同T2070244001-000一样

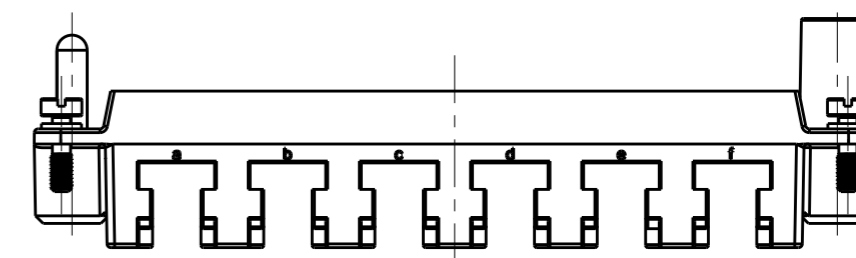
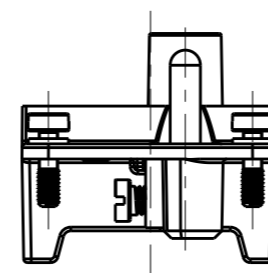
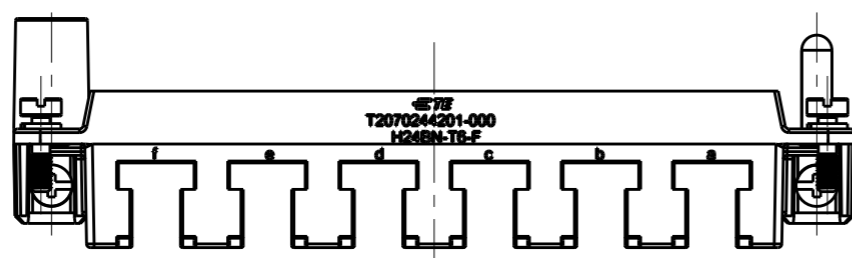

THIS DRAWING IS A CONTROLLED DOCUMENT.

DIMENSIONS:	TOLERANCES UNLESS OTHERWISE SPECIFIED:
mm	0 PLC ±-
	1 PLC ±-
	2 PLC ±-
	3 PLC ±-
	4 PLC ±-
	ANGLES ±-

MATERIAL	FINISH
-	-
-	-

DWN	28FEB2015
DAVID WANG	
CHK	28FEB2015
CHRIS WANG	
APVD	28FEB2015
XIANG XU	
PRODUCT SPEC	108-137057
APPLICATION SPEC	114-137057
WEIGHT	-
Customer Drawing	



NAME		H24BN-T6	
SIZE	CAGE CODE	DRAWING NO	RESTRICTED TO
A3	-	©-T2070244001000	-
SCALE	SHEET	OF	REV
1:1	2	3	B

REVISIONS

P	LTR	DESCRIPTION	DATE	DWN	APVD
-		SEE SHEET 1	-	-	-

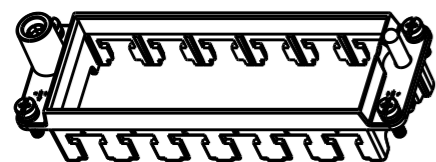

SCALE 1:2

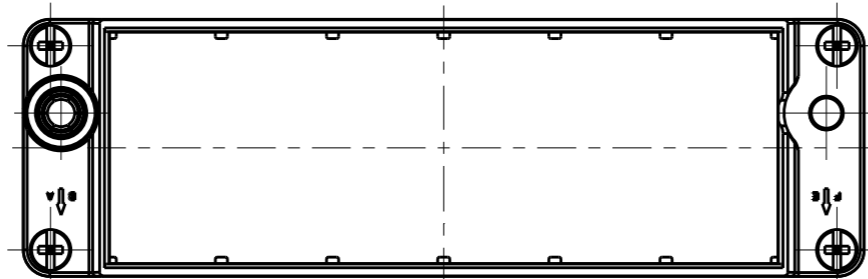

T2070244101-001, H24BN-T6-M SHOWN WITH MARK,
 WITHOUT LOGO, ALL DIMENSIONS THE SAME TO T2070244001-000
 T2070244101-001, H24BN-T6-M, 带标记, 不带LOGO, 所有尺寸同T2070244001-000一样

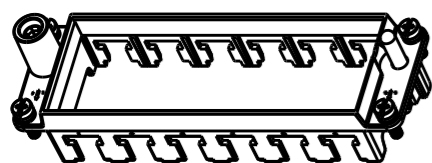
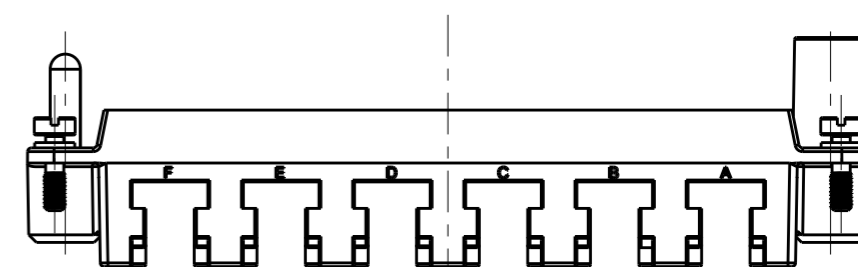
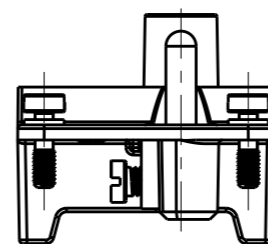
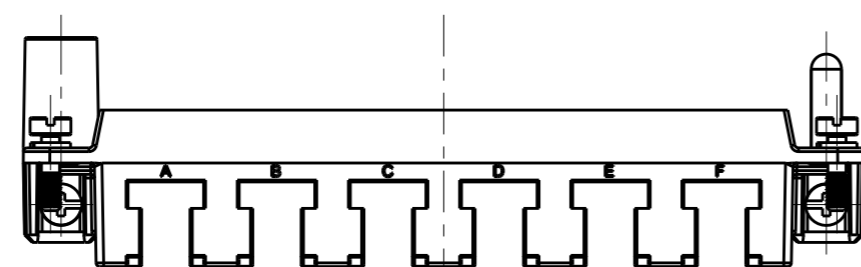

SCALE 1:2

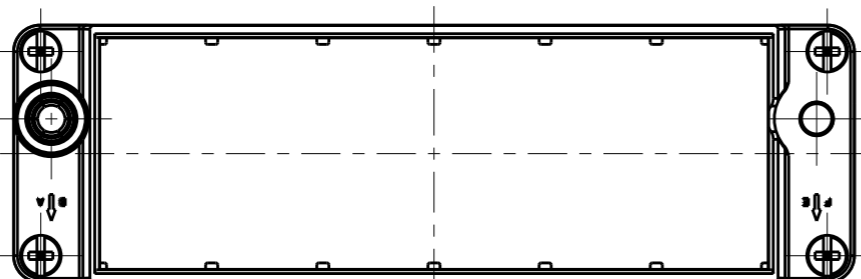

T2070244201-001, H24BN-T6-F SHOWN WITH MARK,
 WITHOUT LOGO, ALL DIMENSIONS THE SAME TO T2070244001-000
 T2070244201-001, H24BN-T6-F, 带标记, 不带LOGO, 所有尺寸同T2070244001-000一样

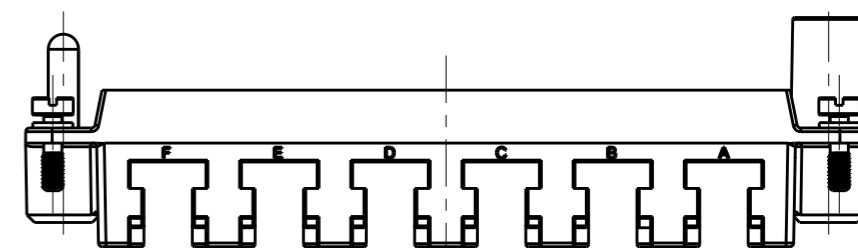
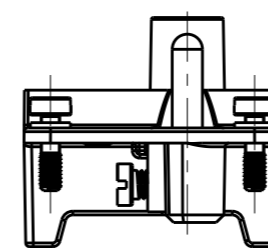
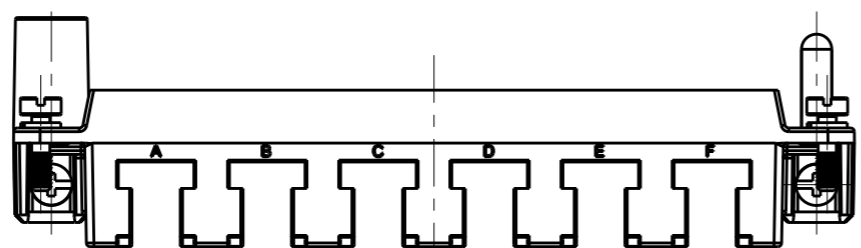

THIS DRAWING IS A CONTROLLED DOCUMENT.

DIMENSIONS:
mm

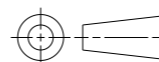

TOLERANCES UNLESS OTHERWISE SPECIFIED:

0 PLC	±-
1 PLC	±-
2 PLC	±-
3 PLC	±-
4 PLC	±-
ANGLES	±-
FINISH	-

MATERIAL

-

DWN 28FEB2015

DAVID WANG

CHK 28FEB2015

CHRIS WANG

APVD 28FEB2015

XIANG XU

PRODUCT SPEC

108-137057

APPLICATION SPEC

114-137057

WEIGHT

-

CUSTOMER DRAWING



TE Connectivity

NAME
H24BN-T6

SIZE	CAGE CODE	DRAWING NO	RESTRICTED TO
------	-----------	------------	---------------

A3

-

©-T2070244001000

-

SCALE	SHEET	OF	REV
1:1	3	3	B