

# SMT COMMON MODE CHOKES

## SLIC Series

Ruggedized



**PulseR**  
Ruggedized Solutions

- Ⓡ Enhanced SLIC platform
- Ⓡ Military/Aerospace Applications
- Ⓡ Dielectric strength: 1500 VRMS
- Ⓡ Designed for DC/DC converters
- Ⓡ Storage Temperature: -55°C to +130°C
- Ⓡ Lead Finish: Sn63/Pb37
- Ⓡ Moisture Sensitivity Level (MSL): 1

### Electrical Specifications 25°C — Operating Temperature -55°C to +130°C

Part Number	Inductance per Winding (uH ±35%)	I <sub>rated</sub> (A)	DCR per winding (mΩ MAX)	Curve (see # below)	Package	Weight (grams)	Quantity in Tube	Quantity in Reel
PL8200	470	14.0	8	9	Big Foot	14.8	15	75
PL8201	630	11.6	10	7	Big Foot	14.3	20	75
PL8202	810	9.70	14	6	Big Foot	13.5	20	75
PL8203	534	7.20	15	8	HCCI-68	7.7	15	100
PL8204	590	5.60	21	7	LCCI-50	5.2	30	200
PL8205	768	4.70	40	6	LCCI-50	4.9	30	200
PL8206	225	3.30	60	5	LCCI-50	4.7	30	200
PL8207	1320	3.30	60	4	LCCI-50	4.6	30	200
PL8208	1470	2.80	80	3	LCCI-50	4.3	30	200
PL8209	880	1.63	110	2	Polecat	1.5	40	500
PL8210	1170	1.22	200	1	Polecat	1.4	40	500
PL8211	10040	1.4	210	10	LCCI-50	4.5	20	200
PL8212	1125	1.8	55	11	Polecat	1.55	40	500
PL8213	800	3	27	12	Polecat	2.46	40	300
PL8214	382.5	3.3	18	13	Polecat	1.71	40	200
PL8215	536	3.8	17.1	14	LCCI-37	2.52	30	200
PL8216	280	4	13.2	15	Polecat	1.6	40	500
PL8217	486	4.2	16	16	LCCI-44LP	2.99	40	300
PL8218	130*	5	6.75	17	Polecat	1.6	40	500
PL8219	96*	6	4.3	18	Polecat	1.7	40	500
PL8220	400	6	9.4	19	LCCI-44LP	3.53	40	200
PL8221	61*	7	2.9	20	Polecat	1.73	40	500
PL8222	484	8	7.7	21	LCCI-50	5.31	30	200
PL8223	1030	9	9.75	22	HCCI-80	14.63	20	75
PL8224	215	10	3.75	23	Makeni	6.26	25	150

#### Notes:

1. The current rating (I<sub>rated</sub>) is based upon the temperature rise of the component and represents the rms current which will cause a typical temperature rise of 55°C with 50LFM forced cooling.
2. The temperature of the component (ambient plus temperature rise) must be within the stated operating temperature range.
4. Optional Tape & Reel packaging can be ordered by adding a "T" suffix to the part number (i.e. PL8200 becomes PL8200T.)
5. To order RoHS compliant parts, add "NL" to the part number (i.e. PL8200 becomes PL8200NL and PL8200T becomes PL8200NLT)

### Impedance Curves

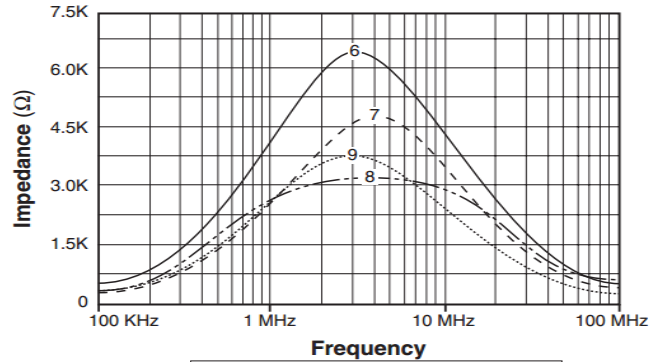

PL8206, PL8207, PL8208, PL8209, PL8210



PL8201, PL8202, PL8203, PL8204, PL8205

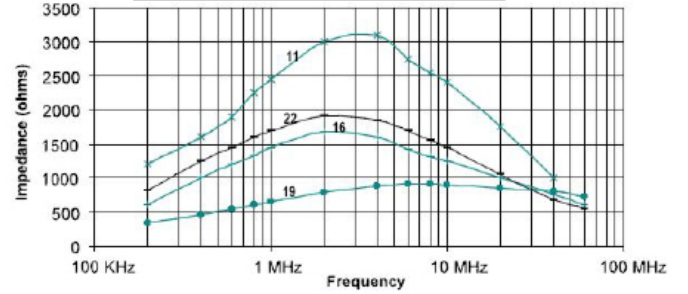

PL8214, PL8222, PL8216, PL8215



PL8223, PL8220, PL8217, PL8212

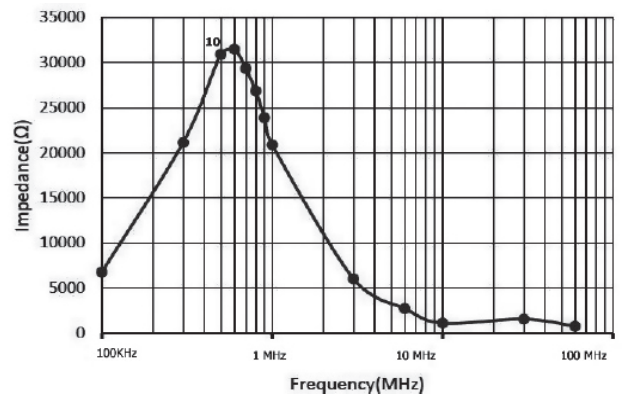

PL8224, PL8219, PL8221

PL8211

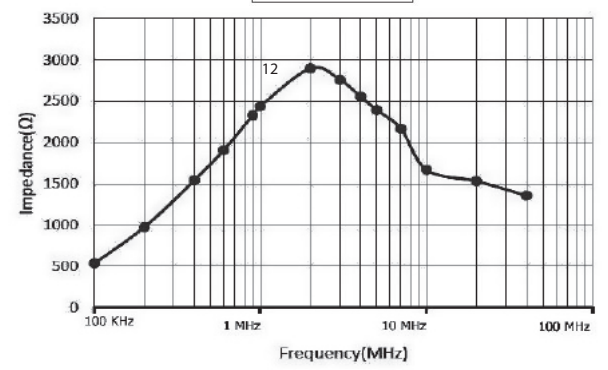

PL8218

PL8213

# SMT COMMON MODE CHOKES

## SLIC Series

Ruggedized

### Mechanicals

### Schematics

LCCI-50, PL8222 & PL8225

LCCI-50

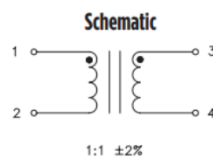

### Mechanicals

### Schematics

LCCI-44LP

HCCI-80, PL8223

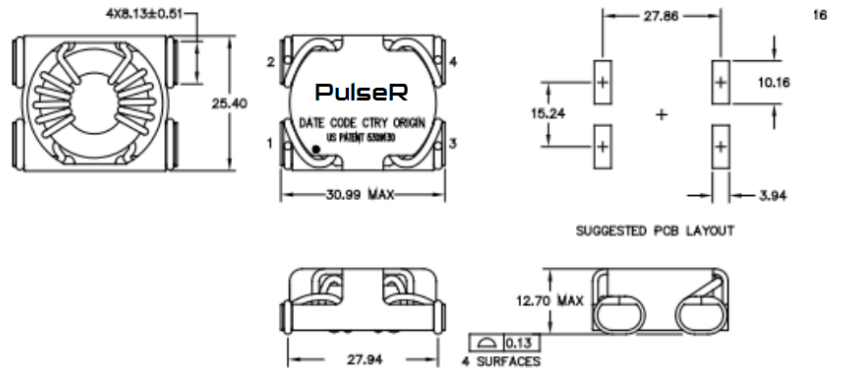

**PoleCat - PL8212, PL8213, PL8214, PL8216, PL8218, PL8219, PL8221**

**Mechanicals**

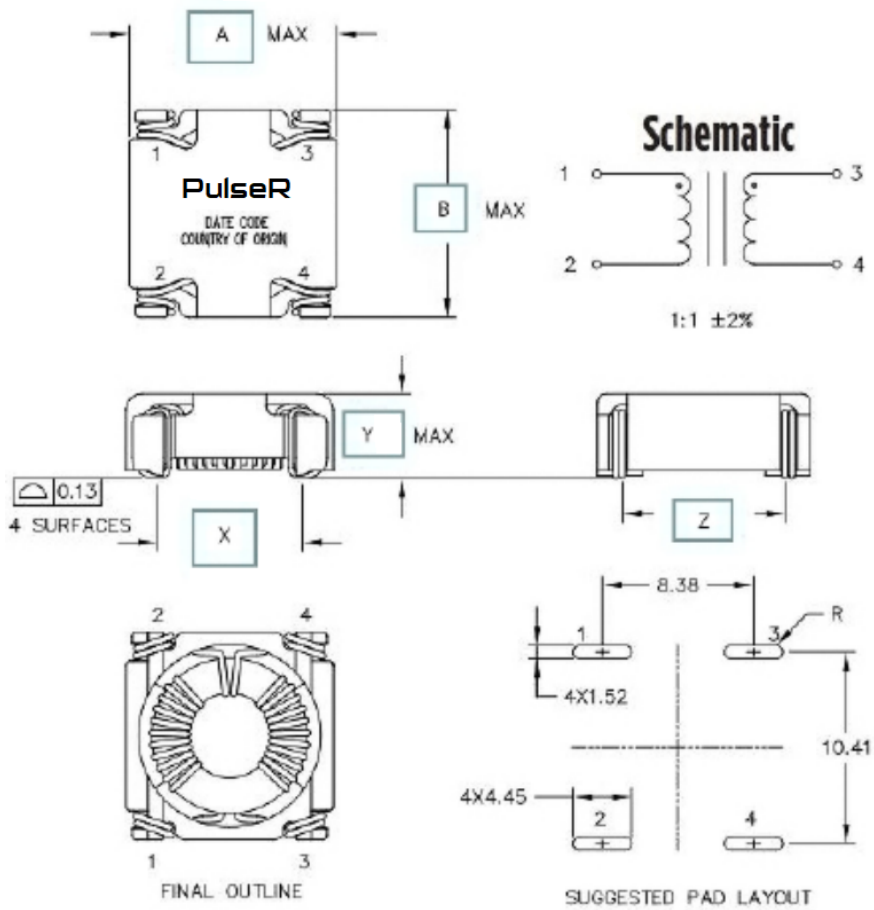

PoleCat Dimensions					
Part number	A	B	X	Y	Z
PL8212	12.7	13.2	8.4	10.4	5.6
PL8213	13.0	13.0	8.4	10.4	8.6
PL8214	13.0	13.0	8.4	10.4	5.6
PL8216	13.0	13.0	8.4	10.4	5.6
PL8218	13.2	13.2	8.6	10.7	5.6
PL8219	13.2	13.2	8.6	10.7	5.6
PL8221	13.5	13.5	8.6	10.7	5.6

### Mechanicals

### Schematics

HCCI-68

Big Foot



Dimensions:  $\frac{\text{Inches}}{\text{mm}}$   
 Unless otherwise specified, all tolerances are  $\pm \frac{.005}{0,13}$

### Mechanicals

### Schematics

LCCI-37

Makeni



Transceiver Tin/Lead Recommended Reflow Profile (Based on J-STD-020D)



$T_{SMIN}$ (°C)	$T_{SMAX}$ (°C)	$T_L$ (°C)	$T_P$ (°C MAX)	$t_s$ (s)	$t_L$ (s)	$t_p$ (s MAX)	Ramp-up rate ( $T_L$ to $T_P$ )	Ramp-down rate ( $T_P$ to $T_L$ )	Time 25°C to peak temperature (s MAX)
100	150	183	225	60-120	60-150	20	3°C/s MAX	6°C/s MAX	360

**Notes:**

1. All temperatures measured on the package leads.
2. Maximum times of reflow cycle: 2.

**For More Information**

**PulseR North America  
Headquarters**

Two Pearl Buck Court  
Bristol, PA 19007  
U.S.A.

Tel: +1. 215. 781. 6400  
Fax: +1. 215. 781. 6403

**For Global Sales Representatives and Locations Visit:**

<http://www.pulseruggedized.com>

Performance warranty of products offered on this data sheet is limited to the parameters specified. Data is subject to change without notice. Other brand and product names mentioned herein may be trademarks or registered trademarks of their respective owners. © Copyright, 2018. PulseR, LLC. All rights reserved.