

PLC-RS.../SEN

PLC INTERFACE With Relay, Sensor Version

INTERFACE

Data Sheet
103151_en_01

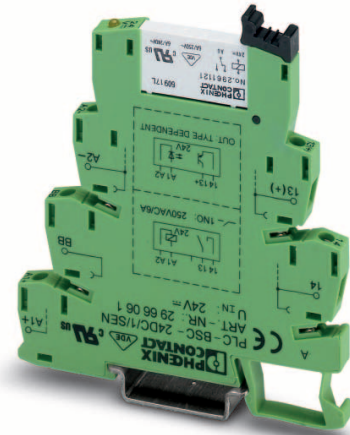

© PHOENIX CONTACT - 03/2008

1 Description

In applications as the interface between the PLC and sensors (e.g., proximity switches, limit switches or auxiliary contacts), as a rule only one N/O contact is required. In this case, the **PLC-RS.../SEN** input module can be used, which is specially optimized for these applications and consists of a 6.2 mm basic terminal block and plug-in miniature relay with screw or spring-cage connection.

1.1 No Need for Power Terminal Blocks

Unlike conventional input relays, all sensor connections, including the supply voltage for the sensors and switches, are connected directly to the PLC INTERFACE module. The PLC-RS.../SEN can thus be used directly as a terminal strip with integrated interface function for the incoming sensor cables, without the need for additional modular terminal blocks (see also INTERFACE catalog).

- Elimination of the need for modular terminal blocks for the sensor/switch supply, signal, and sensor ground
- Space savings of around 80%
- Time saving of around 60%
- Reduction in wiring due to plug-in bridges

1.2 Optimum Use of Plug-In Bridges

The PLC INTERFACE module achieves maximum efficiency with the user-friendly FBST plug-in bridge system. The PLC-RS.../SEN makes effective use of the bridging options for the power supply for sensors/switches, for the supply/sensor ground at the A2 connection, and for the common supply potential of the PLC at connection 13. Especially effective here are the 500 mm long color-insulated continuous plug-in bridges that can easily be cut to the required length and quickly inserted in the bridge shafts. They eliminate the need for complicated and time-consuming loop bridges – the reduction in wiring by eliminating the need for modular terminal blocks and the use of all bridging options is around 60%.

1.3 Additional Advantages

- Operational safety with RT III (IP67)-protected mechanics
- Environmentally friendly, cadmium-free power contact material for loads up to 250 V AC/6 A
- Available with gold coating for low power levels (mA) as an option
- Integrated input circuit
- Relay can be replaced using an engagement lever
- Safe isolation according to DIN EN 50178
- Inflammability class V0 according to UL94





Make sure you always use the latest documentation.
It can be downloaded at www.download.phoenixcontact.com.
A conversion table is available on the Internet at
www.download.phoenixcontact.com/general/7000_en_00.pdf.



This data sheet is valid for all products listed on the following page:



2 Ordering Data

PLC INTERFACE With Screw Connection

Description	Type	Order No.	Pcs./Pck.	
PLC INTERFACE With Universal Multi-Layer Contact Relay, Sensor Version				
PLC INTERFACE, comprising PLC-BSC.../SEN basic terminal block and plug-in miniature relay (see INTERFACE catalog), for mounting on 	24 V DC	PLCRSC- 24DC/1AU/SEN	2966317	10
	120 V AC/110 V DC	PLCRSC-120UC/1AU/SEN	2966320	10
	230 V AC/220 V DC ¹	PLCRSC-230UC/1AU/SEN	2966333	10
PLC INTERFACE With Power Contact Relay, Sensor Version				
PLC INTERFACE, comprising PLC-BSC.../SEN basic terminal block and plug-in miniature relay (see INTERFACE catalog), for mounting on 	24 V DC	PLCRSC- 24DC/1/SEN	2966223	10
	120 V AC/110 V DC	PLCRSC-120UC/1/SEN	2966249	10
	230 V AC/220 V DC ¹	PLCRSC-230UC/1/SEN	2966252	10

¹ The PLC-ATP BK insulating plate must be installed for voltages greater than 250 V (L1, L2, L3) between the same terminal points on adjacent modules (see "Accessories"). FBST 8-PLC... or FBST 500... is then used for potential bridging.

PLC INTERFACE With Spring-Cage Connection

Description	Type	Order No.	Pcs./Pck.	
PLC INTERFACE With Universal Multi-Layer Contact Relay, Sensor Version				
PLC INTERFACE, comprising PLC-BSP.../SEN basic terminal block and plug-in miniature relay (see INTERFACE catalog), for mounting on 	24 V DC	PLCRSP- 24DC/1AU/SEN	2967374	10
	120 V AC/110 V DC	PLCRSP-120UC/1AU/SEN	2967390	10
	230 V AC/220 V DC ¹	PLCRSP-230UC/1AU/SEN	2967413	10
PLC INTERFACE With Power Contact Relay, Sensor Version				
PLC INTERFACE, comprising PLC-BSP.../SEN basic terminal block and plug-in miniature relay (see INTERFACE catalog), for mounting on 	24 V DC	PLCRSP- 24DC/1/SEN	2967361	10
	120 V AC/110 V DC	PLCRSP-120UC/1/SEN	2967387	10
	230 V AC/220 V DC ¹	PLCRSP-230UC/1/SEN	2967400	10

¹ The PLC-ATP BK insulating plate must be installed for voltages greater than 250 V (L1, L2, L3) between the same terminal points on adjacent modules (see "Accessories"). FBST 8-PLC... or FBST 500... is then used for potential bridging.



With the 120 V and 230 V modules, an REL-MR-60DC/... 60 V relay is normally used due to the input circuit integrated in the basic terminal block. For the protection of input and output, inductive loads must be dampened with an effective protective circuit.

Accessories

Description	Type	Order No.	Pcs./Pck.
Insulating plate	PLC-ATP BK	2966841	25



The PLC-ATP BK insulating plate should be used in the following cases: always fit at the start and end of a PLC terminal strip for voltages greater than 250 V (L1, L2, L3) between the same terminal points on adjacent modules (FBST 8-PLC... or FBST 500... can be used for potential bridging) and for safe isolation between adjacent modules.

For additional accessories such as power terminal blocks and plug-in bridges, please refer to the INTERFACE catalog or www.phoenixcontact.com.

3 Technical Data

Input Data	...24DC...	...120UC...	...230UC...
Nominal input voltage ¹	24 V DC	120 V AC/ 110 V DC	230 V AC/ 220 V DC
Permissible range (with reference to U_N)	See "Operating Voltage Ranges" on page 5		
Typical input current at U_N	9 mA	3.5 mA/3 mA	3 mA
Typical response time at U_N	4 ms	6 ms	7 ms
Typical release time at U_N	8 ms	15 ms	15 ms
Input circuit	Yellow LED, protection against polarity reversal, free-wheeling diode	Yellow LED, bridge rectifier	

¹ The PLC-ATP BK insulating plate must be installed for voltages greater than 250 V (L1, L2, L3) between the same terminal points on adjacent modules (see "Accessories"). FBST 8-PLC... or FBST 500... is then used for potential bridging.

Output Data	PLCRSC-...1/SEN	PLCRSC-...1AU/SEN
Contact type	Single contact, SPDT	
Contact material	AgSnO	AgSnO + 5 μ A ¹
Maximum switching voltage	250 V AC/DC ²	30 V AC/36 V DC
Minimum switching voltage	12 V AC/DC	100 mV
Limiting continuous current	6 A	50 mA
Maximum inrush current	30 A (for AC 15 operation)	50 mA
Minimum switching current	10 mA	1 mA
Maximum shutdown power	Ohmic load $\tau = 0$ ms	Ohmic load $\tau = 0$ ms
	24 V DC	140 W
	48 V DC	20 W
	60 V DC	18 W
	110 V DC	23 W
	220 V DC	40 W
	250 V AC	1500 VA
Minimum switching power	120 mW	10 μ W

¹ If the specified maximum values are exceeded, the gold coating will be damaged. In subsequent operation, the AgSnO contact values given here will apply. This can then result in reduced service life, similar to dedicated power contacts.

² The PLC-ATP BK insulating plate must be installed for voltages greater than 250 V (L1, L2, L3) between the same terminal points on adjacent modules (see "Accessories"). FBST 8-PLC... or FBST 500... is then used for potential bridging.

General Data	
Impulse voltage withstand level	4 kV, 50 Hz, 1 min.
Ambient temperature range	
Operation	-20°C ... 60°C (230 V type 20°C ... 55°C)
Storage/transport	-40°C ... 85°C
Nominal operating mode	100% operating factor
Inflammability class according to UL 94 (housing)	V0
Mechanical service life	2×10^7 cycles
Air and creepage distances between the circuits ¹	IEC 60664, IEC 60664 A, DIN VDE 0110, DIN EN 50178/VDE 0106-160, IEC 60255/DIN VDE 0435
Pollution degree	3
Surge voltage category	III
Mounting position	Any
Mounting	Can be aligned without spacing
Conductor cross-section	
Solid, with screw connection	0.14 mm ² ... 2.5 mm ² (26 - 14 AWG)
Stranded, with screw connection	0.14 mm ² ... 1.5 mm ² (26 - 14 AWG)
Solid, with spring-cage connection	0.2 mm ² ... 2.5 mm ² (24 - 14 AWG)
Stranded, with spring-cage connection	0.2 mm ² ... 1.5 mm ² (24 - 14 AWG)

General Data (Continued)

Stripping length	
Screw connection	10 mm
Spring-cage connection	8 mm
Dimensions (W x H x D)	6.2 mm x 94 mm x 80 mm
Housing material	Polyamide PA, green

¹ The PLC-ATP BK insulating plate must be installed for safe isolation between adjacent modules (see "Accessories"). FBST 8-PLC... or FBST 500... is then used for potential bridging.

Tests/Approvals

CE	CE
UL	UL, cULus
GL	GL

4 Block Diagram

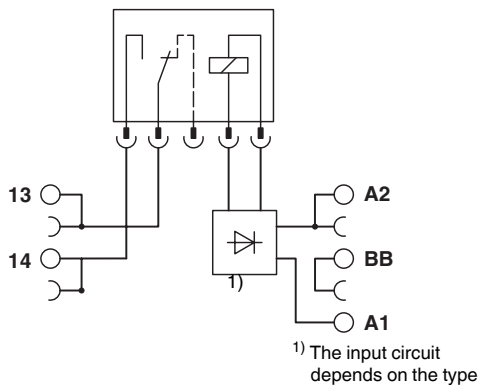

5 Operating Voltage Ranges

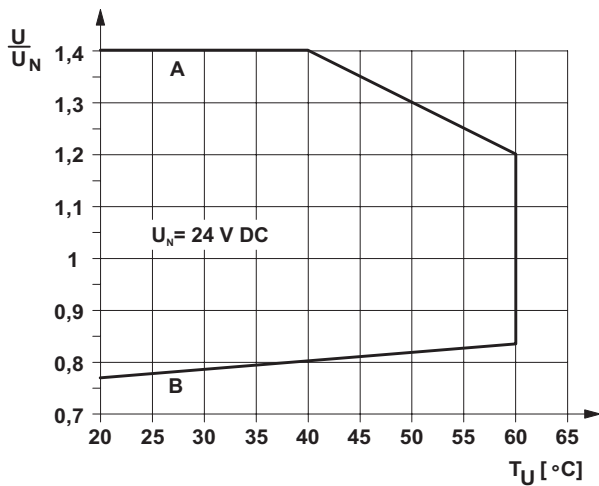

Figure 1 Operating voltage range for 24 V DC

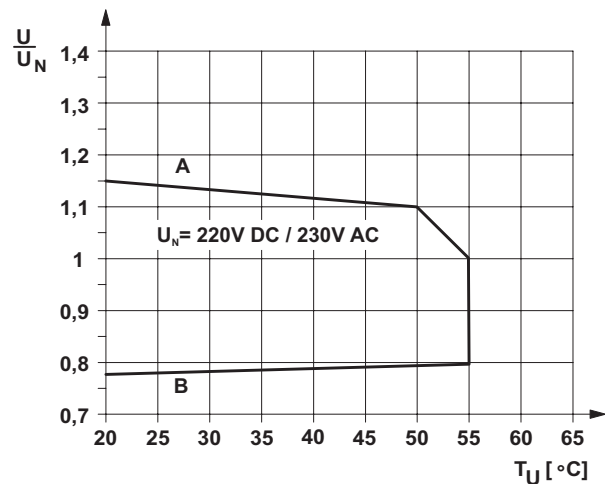

Figure 3 Operating voltage range for 230 V AC/DC

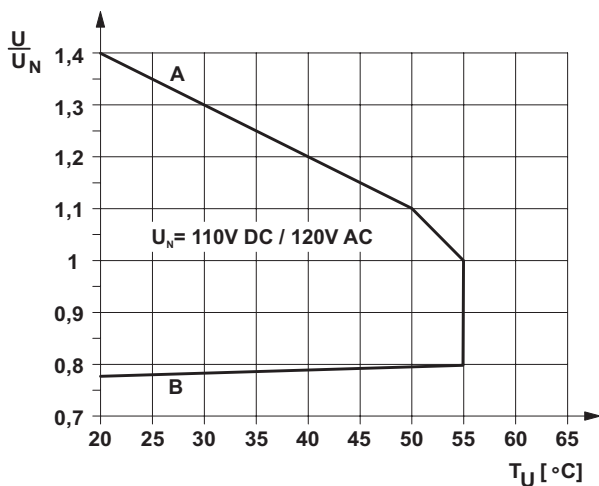

Figure 2 Operating voltage range for 120 V AC/DC

General Conditions

Direct alignment in the block, all devices 100% operating factor, horizontal or vertical mounting.

Curve A

Maximum permissible continuous voltage U_{max} with limiting continuous current on the contact side

Curve B

Minimum permissible operate voltage U_{op} following pre-excitation