

Small Signal Product

225mW, SMD Switching Diode

FEATURES

- Low power loss, high current capability, low VF
- Surface device type mounting
- Moisture sensitivity level 1
- Matte Tin (Sn) lead finish with Nickel (Ni) under plate
- Pb free version and RoHS compliant
- Packing code with suffix "G" means green compound (halogen-free)



SOT-23



MECHANICAL DATA

- Case: SOT- 23, molded plastic
- Terminal: Matte tin plated, lead free, solderable per MIL-STD-202, Method 208 guaranteed
- High temperature soldering guaranteed: 260°C/10s
- Weight: 8 mg (approximately)
- Marking Code: JV

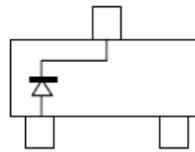

MAXIMUM RATINGS AND ELECTRICAL CHARACTERISTICS (T _A =25°C unless otherwise noted)			
PARAMETER	SYMBOL	VALUE	UNIT
Power Dissipation	P _D	225	mW
Repetitive Peak Reverse Voltage	V _{RRM}	75	V
Mean Forward Current	I _O	200	mA
Non-Repetitive Peak Forward Surge Current @ t = 1.0 s	I _{FSM}	500	mA
Thermal Resistance (Junction to Ambient) (Note 1)	R _{θJA}	330	°C/W
Junction and Storage Temperature Range	T _J , T _{STG}	-55 to +150	°C

PARAMETER	SYMBOL	MIN	MAX	UNIT
Reverse Breakdown Voltage I _R = 100 μA	V _{BR}	75	-	V
Forward Voltage I _F = 1 mA I _F = 10 mA I _F = 50 mA I _F = 150 mA	V _F	-	0.9	V
		-	1.0	
		-	1.1	
		-	1.25	
Reverse Leakage Current V _R = 75 V	I _R	-	T _J =25°C 5	nA
			T _J =150°C 80	
Junction Capacitance V _R = 0 V , f = 1.0 MHz	C _J	-	2.0	pF
Reverse Recovery Time (Note 2)	t _{rr}	-	3.0	ns

Notes : 1. Valid provided that electrodes are kept at ambient temperature
 2. Reverse recovery test conditions : I_F=10mA , I_R=10mA , R_L=100 Ω, I_{RR}= 1mA

Small Signal Product

RATINGS AND CHARACTERISTICS CURVES

($T_A=25^\circ\text{C}$ unless otherwise noted)

Fig. 1 Typical Forward Characteristics

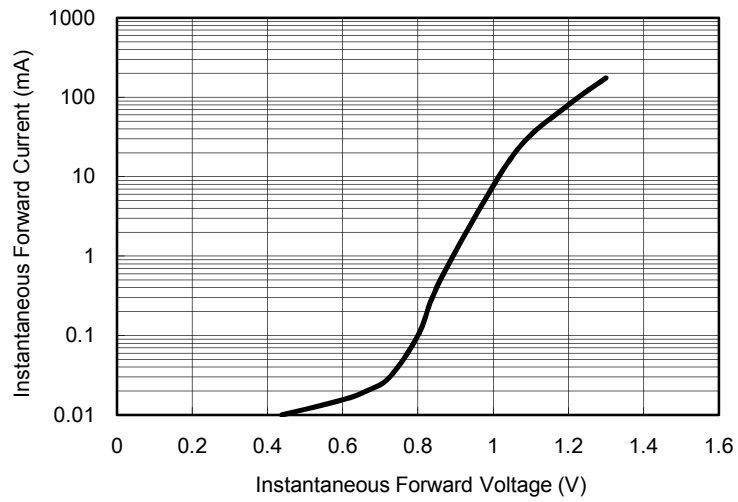

Fig. 2 Reverse Current vs. Reverse Voltage

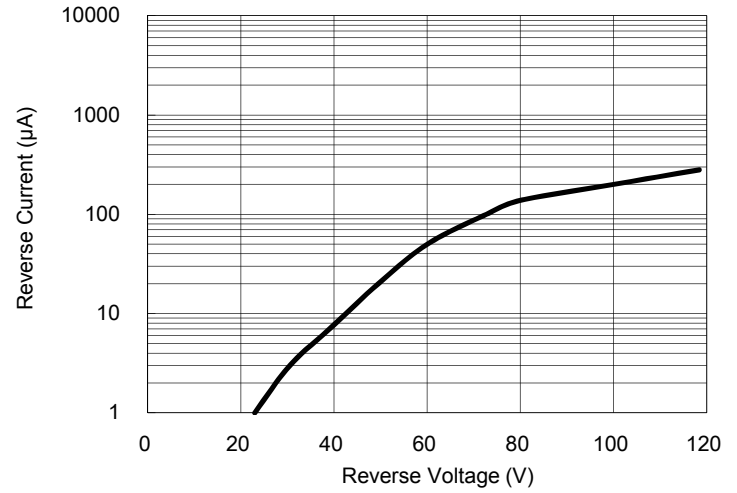

Fig. 3 Admissible Power Dissipation Curve

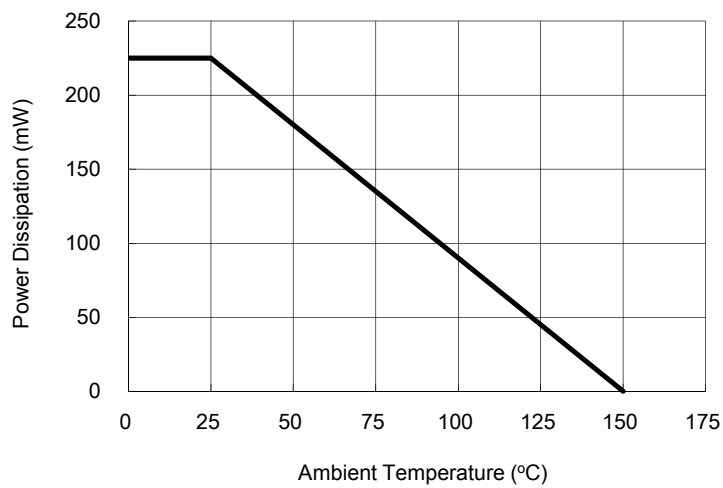
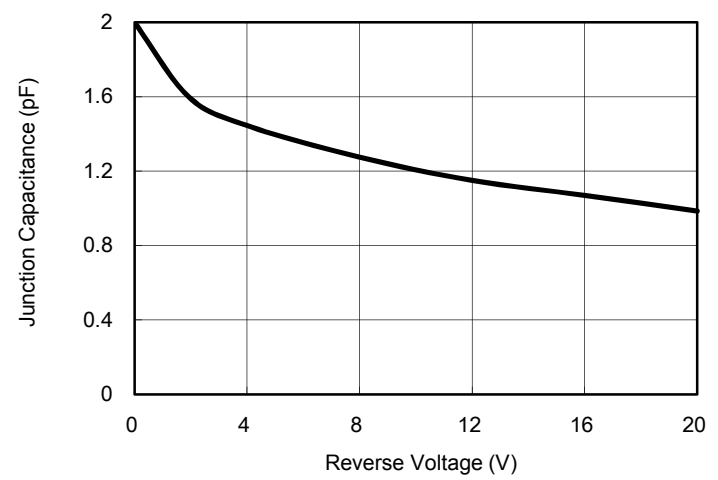

Fig. 4 Typical Junction Capacitance



Small Signal Product

ORDERING INFORMATION				
PART NO.	PACKING CODE	PACKING CODE SUFFIX	PACKAGE	PACKING
BAS116	RF	G	SOT-23	3K / 7" Reel

EXAMPLE				
PREFERRED P/N	PART NO.	PACKING CODE	PACKING CODE SUFFIX	DESCRIPTION
BAS116 RFG	BAS116	RF	G	Green compound

PACKAGE OUTLINE DIMENSIONS

SOT-23

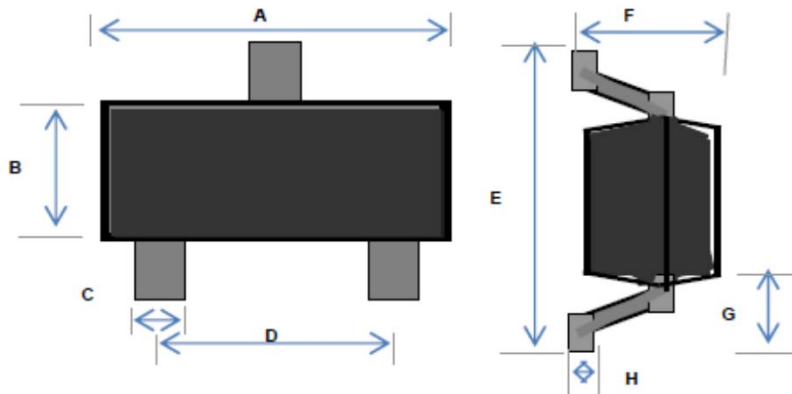

DIM.	Unit (mm)		Unit (inch)	
	Min	Max	Min	Max
A	2.70	3.10	0.106	0.122
B	1.10	1.50	0.043	0.059
C	0.30	0.51	0.012	0.020
D	1.78	2.04	0.070	0.080
E	2.10	2.64	0.083	0.104
F	0.89	1.30	0.035	0.051
G	0.55 REF		0.022 REF	
H	0.10 REF		0.004 REF	

SUGGESTED PAD LAYOUT

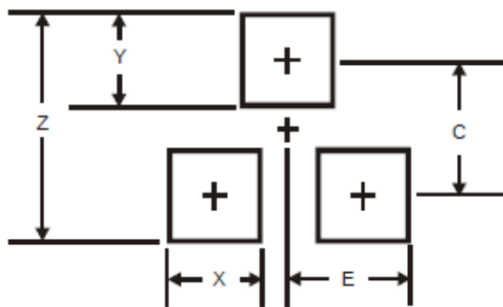

DIM.	Unit (mm)	Unit (inch)
	Typ.	Typ.
Z	2.8	0.110
X	0.7	0.028
Y	0.9	0.035
C	1.9	0.075
E	1.0	0.039

Notice

Specifications of the products displayed herein are subject to change without notice. TSC or anyone on its behalf, assumes no responsibility or liability for any errors or inaccuracies.

Information contained herein is intended to provide a product description only. No license, express or implied, to any intellectual property rights is granted by this document. Except as provided in TSC's terms and conditions of sale for such products, TSC assumes no liability whatsoever, and disclaims any express or implied warranty, relating to sale and/or use of TSC products including liability or warranties relating to fitness for a particular purpose, merchantability, or infringement of any patent, copyright, or other intellectual property right.

The products shown herein are not designed for use in medical, life-saving, or life-sustaining applications. Customers using or selling these products for use in such applications do so at their own risk and agree to fully indemnify TSC for any damages resulting from such improper use or sale.