

DRAWING NUMBER: 1106571
 REVISION: I

CABLE CUTTING
 CABLE SOURCE :
 1. BAO HING(SHENZHEN).(FOR S/N 1)
 2. TONG YUAN(SHENZHEN).(FOR S/N 1)
 3. TA HSIANG(SHENZHEN).(FOR S/N 1)
 4. WONDERFUL.(FOR S/N 2)

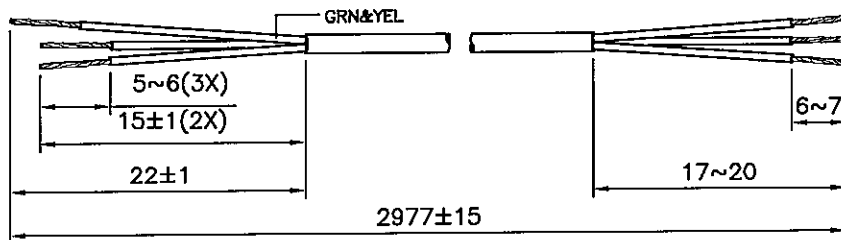

ASSEMBLY :

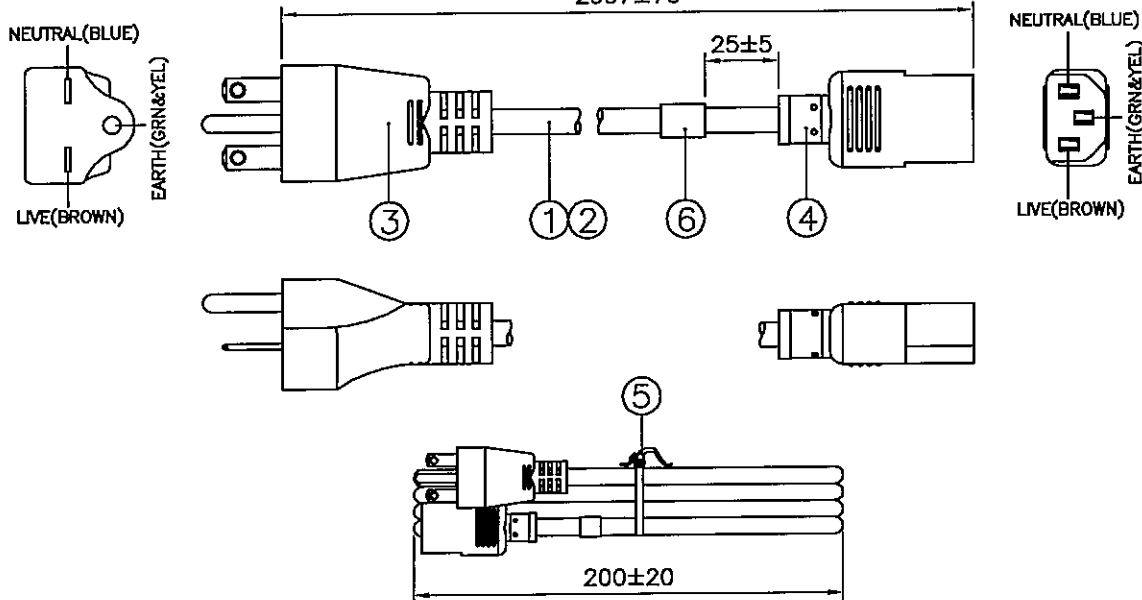

Notes :

- ALL DIMENSIONS IN mm.
- PLUG AND CONNECTOR MARKING : REFER TO MARKING DRAWING NO. : VP-0145C AND VC-0157 RESPECTIVELY.
- PLUG AND CONNECTOR DETAILS : REFER TO PRODUCT DRAWING NO. : P-0323 AND C-0230 RESPECTIVELY.
- LABEL DETAILS : REFER TO LABEL DRAWING NO. : VL-0356.
- CARTON BOX MUST HAVE A LABEL/STAMP SAYING : "THIS PACKAGE CONTAINS CORDS HAVING GROUNDING CONDUCTOR WITH GREEN/YELLOW COLOUR INSULATION, NEUTRAL CONDUCTOR WITH BLUE COLOUR INSULATION AND LIVE CONDUCTOR WITH BROWN COLOUR INSULATION".
- THIS PART CAN BE MANUFACTURED AT ANY LOCATION WHICH HAS SAFETY APPROVAL.

REV.	ECR REF. NO.	DESCRIPTION	DATE
H	120243	REMOVE CABLE SOURCE 'SANLUNG' & 'AWIN'.	27/04/12
I	150232	CHANGE PLUG MARKING DWG. NO. FM. 'VP-0145' TO 'VP-0145C'.	15/05/15

6	PRINTED LABEL	VL-0356	1
5	8" PE TIE BLK	6310062	1
4	IP50G NL7977B BLK	4100098	-
	MOLDED CONNECTOR 386A (10A 250V)	386A	1
3	IP40G NL792B BLK	4100017	-
	MOLDED PLUG VS205S (10A 250V)	VS205S-13	1
2	SVT 18/3 60°C BBGY BLK LF (OD 6.1)	1810287	OR
1	SVT 18/3 60°C BBGY BLK PVC LEAD FREE	1810121	2.977M

S/N	DESCRIPTION	ITEM NUMBER	QTY
TITLE : NORTH-AMERICAN POWER SUPPLY CORDSET (RoHS COMPLIANT)		PAGE : 1/2	
CUSTOMER : VIS/VOLEX INC		HG01-158-07	
CUSTOMER PART NUMBER : 17567 1Ø C3		DWG. TYPE	
F/G CODE : 17567 1Ø C3		SPEC NO. : ---	OED

SALES : N.A.	QA : N.A.	ENGRG : Feng	CHECKED BY : Sandy Yu	DRAWN BY : SANDY YU	Volex (Asia) Pte Ltd <small>Confidential property of Volex. Information contained herein shall not be disclosed to others, reproduced or used for any other purposes except as authorized in writing by an authorized official of Volex Asia.</small>
DATE : N.A.	DATE : N.A.	DATE : 23/05/15	DATE : 16/05/15	DATE : 15/05/15	

DRAWING NUMBER :

1106571

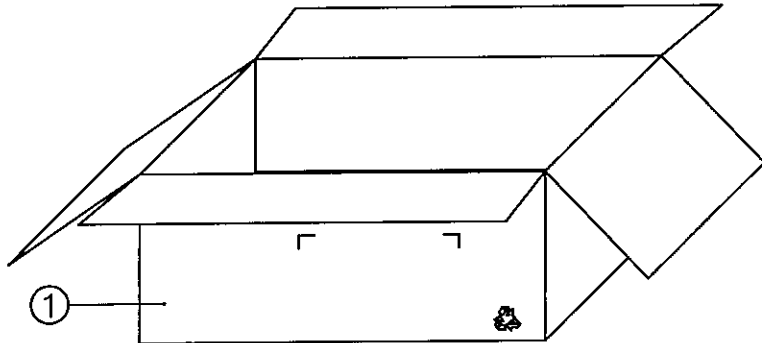
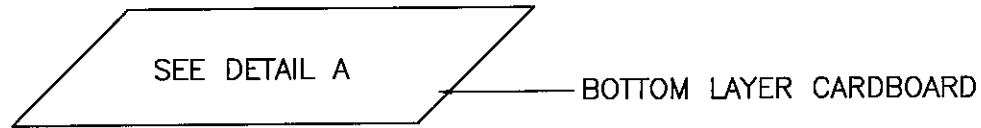
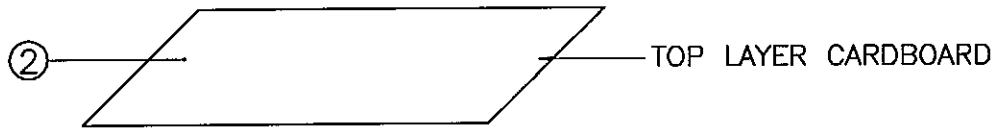

PACKAGING INSTRUCTION

1. ALL CORDSETS LAYOUT AS DETAIL.
2. PACKAGING : 25 PCS PER CARTON.

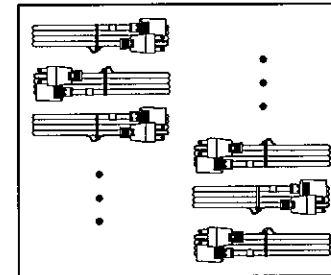

DETAIL A

NOTE :

1.) ALL DIMENSIONS IN mm.

2	CARTON LAYER PAD 420X350MM	901022	0.08
1	CARTON 430X360X160 RL1086	901015	0.04
S/N	DESCRIPTION	ITEM NUMBER	QTY
REVISION	1	TITLE : PACKAGING SPEC.	
PAGE	2/2		
SCALE	N.T.S.		
REFERENCE :		Volex (Asia) Pte Ltd	
DESCRIPTION : CARTON BOX		<small>Confidential property of Volex. Information contained herein shall not be disclosed to others, reproduced or used for any other purposes except as authorized in writing by an authorized official of Volex Asia.</small>	