

THIS DRAWING IS UNPUBLISHED. RELEASED FOR PUBLICATION 20
© COPYRIGHT 20 BY - ALL RIGHTS RESERVED.

LOC	DIST	REVISIONS			
P	LTR	DESCRIPTION	DATE	DWN	APVD
-	-	A	REVISED AS PER ECR-15-005925	21APR2015	RS JL

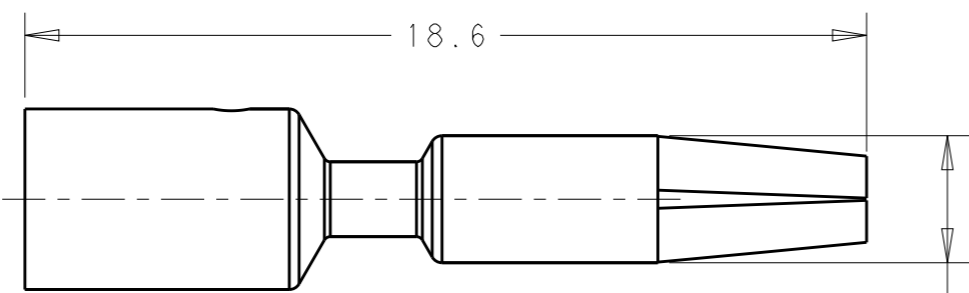

STYLE A

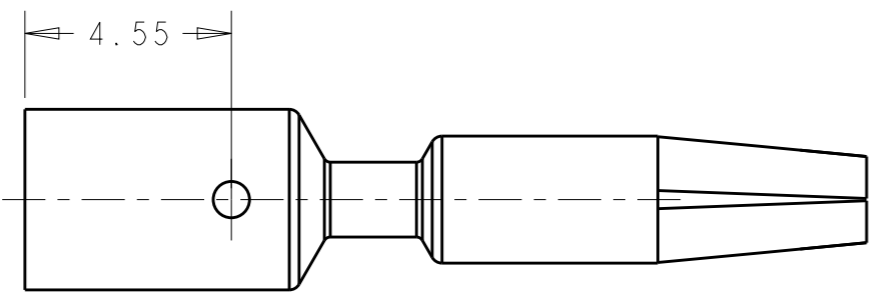
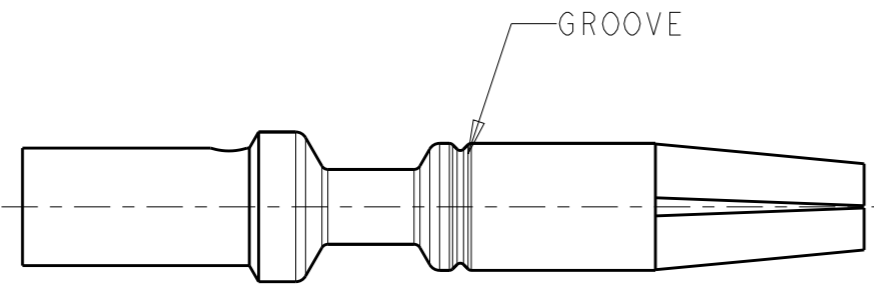

STYLE B

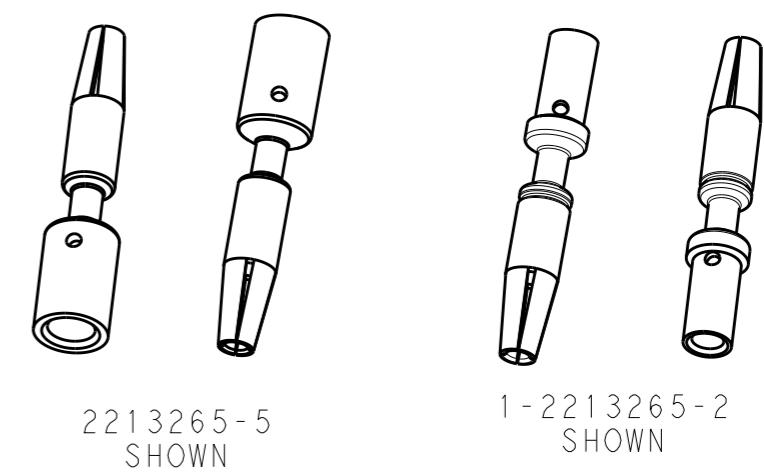
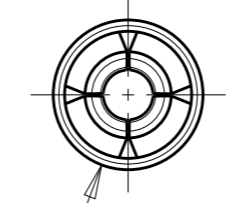
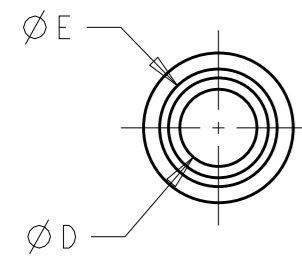
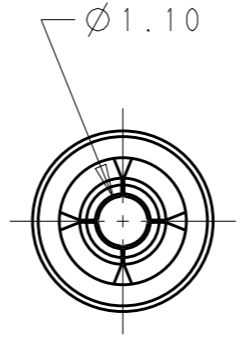
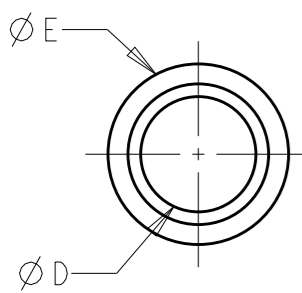

- NOTES:
- MATERIALS AND FINISH:
COPPER ALLOY, FINISH: Sn OVER Ni
 - MUST COMPLY WITH DIRECTIVE 2002/95/EC (ROHS)
 - THIS PRODUCT HAS NOT COMPLETED VALIDATION TESTING

16/18	2.59	1.70	1	B	1-2213265-2
14	3.98	2.54	N/A	A	2213265-5
WIRE (AWG)	DIM. "E"	DIM. "D"	NO OF GROOVES	BARREL STYLE	PART NO

THIS DRAWING IS A CONTROLLED DOCUMENT.		DWN RAVI.S 28MAY2013	 TE Connectivity		
DIMENSIONS: mm		CHK C GINGRICH 28MAY2013			
TOLERANCES UNLESS OTHERWISE SPECIFIED:		APVD C GINGRICH 28MAY2013	NAME MACHINED SOCKET CONTACT NECTOR M-LINE		
0 PLC ± 1 PLC ±0.3 2 PLC ±0.15 3 PLC ± 4 PLC ± ANGLES ±		PRODUCT SPEC 108-133014	RESTRICTED TO		
MATERIAL NOTE 1		APPLICATION SPEC 114-32111	SIZE A3	CAGE CODE 00779	DRAWING NO C-2213265
FINISH NOTE 1		WEIGHT -	SCALE 4:1 SHEET 1 OF 1 REV A		
		Customer Drawing			