

**Product Range**



**Pushbutton Switches**

- **Tiny Push Buttons:** TP, TSP Series
- **Panel Mount Push Buttons:** MSP, MPA Series
- **Higher Current Push Buttons:** MP Green-, A 60 Series

**Main features:**

- Up to 4 poles
- N/O or C/O contact configuration
- Gold or silver contacts
- Sealed or unsealed versions
- Right angle versions
- Single or dual actuator
- Round or rectangular actuator buttons
- Flush actuator versions
- Snap action versions
- Bushing versions with and without thread
- Hermetically sealed versions
- THT or wire lug terminals
- Panel mounting versions
- Accessories: boot seals, caps, ...



**TSP Series, Tiny, Process Sealed** .....page D3



**TP Series, Tiny** .....page D6



**TP\_ES Series, Tiny, Process Sealed** .....page D15



**MSPM Series, Magnetic Reed, Long Life, Hermetically Sealed** .....page D18

**Product Range** (Continued)



**MSPF Series, Front or Rear Mount, 15/32 Bushing** .....page D20



**MPA103 Series, Panel Mount** .....page D22



**MSP103 Series, 2.5mm Travel, Panel Mount** .....page D23



**MPS Series, Snap Action** .....page D25



**MP/A/E/G Green Series** .....page D28



**A60 Series** .....page D33



**Accessories** .....page D35



**BP Series Boot Seals** .....page D37



**BP Series Panel Seals** .....page D39

**TSP Series, Tiny, Process Sealed**

**Features**

- Washable process sealed construction (internal "O" ring)
- Compact design



**Typical performance characteristics**

Contact configuration . . . . . SPST SPDT  
 Contact timing . . . . . Break-Before-Make  
 Contact rating max. . . . . gold 0.4VA @20VAC/DC  
 Electrical life . . . . . function C: 80,000 cycles  
 . . . . . function F: 60,000 cycles  
 Contact resistance, initial . . . . . max.20 mOhms  
 Insulation resistance . . . . . 1,000 MOhms @ 500VDC  
 Dielectric strength . . . . . function C: 1,000 Volts rms @ sea level  
 . . . . . function F: 500 Volts rms @ sea level  
 Actuator travel . . . . . momentary .035" (0.89)

**Environmental specification**

Operating temperature . . . . . -30°C to +85°C  
 Storage temperature . . . . . -55°C to +85°C  
 Solder heat resistance . . . . . wave solder capable to 265° C  
 Seal . . . . . process sealed with internal "O" ring

**Material specifications**

Contacts . . . . . copper or brass, gold over nickel finish  
 Actuator . . . . . thermoplastic  
 Terminals . . . . . brass with gold over nickel in contact area  
 . . . . . tin over nickel in solder area  
 Case . . . . . thermoplastic (LCP)  
 Spring . . . . . music wire zinc plated  
 Support bracket . . . . . steel tin plated  
 Seal . . . . . "O" ring rubber  
 RoHS Directive 2002/95/EC . . . . . compliant

Product key		Typical product key										
		TSP	D		1	1	C	G	RA	0	04	
<b>Type</b>	<b>TSP</b>	Tiny pushbutton, process sealed										
<b>Bushing</b>	<b>D</b>	plain, not threaded										
<b>Actuator</b>	<b>blank</b>	length .200 (5.08)										
	<b>F</b>	flush										
<b>Number of Poles</b>	<b>1</b>	single pole										
<b>Contact rating</b>	<b>1</b>	0.4VA Gold										
<b>Function</b>	<b>C</b>	SPST, Off (On)				<b>F</b> SPDT, On (On)						
<b>Plating</b>	<b>G</b>	Gold										
<b>Terminals</b>	<b>PC</b>	printed circuit board				<b>RA</b> right angle						
	<b>PCV</b>	printed circuit board, w bracket				<b>VRA</b> vertical right angle						
						<b>WW</b> wire wrap						
<b>Button Color</b>	<b>0</b>	black				<b>2</b> red						
<b>Material</b>	<b>04</b>	RoHS compliant										

**TSP Series, Tiny, Process Sealed (Continued)**

**Actuator**



blank, F

**standard actuator, flush actuator**

blank, standard actuator

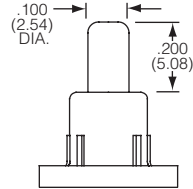

F, flush actuator

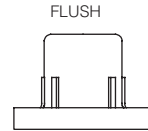

**Terminations**



**PC**

**printed circuit board**



TSPD11CPC004

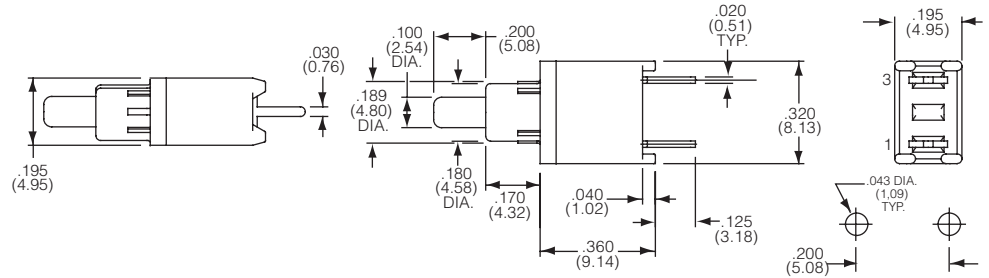

**PCV**

**printed circuit board with vertical bracket**

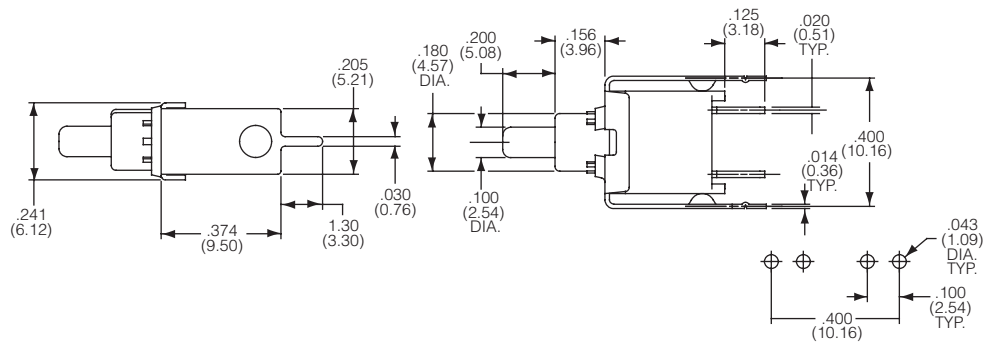

**RA**

**right angle**

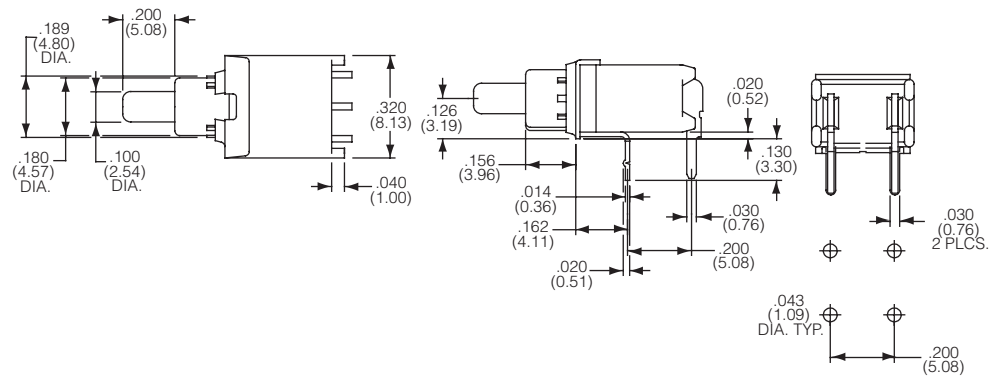

**TSP Series, Tiny, Process Sealed (Continued)**

**VRA**

**vertical right angle**

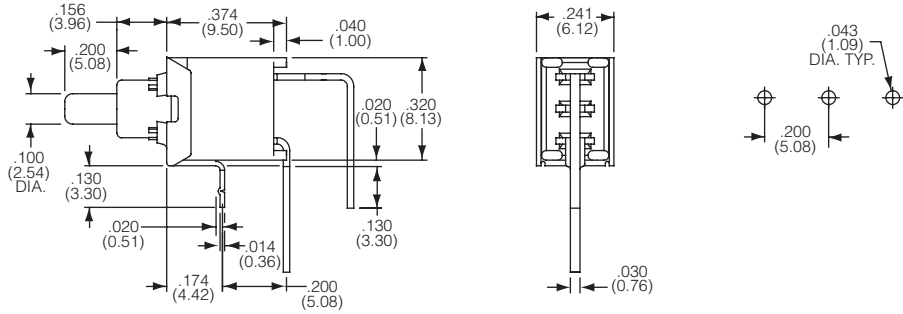

**WW**

**wire wrap**

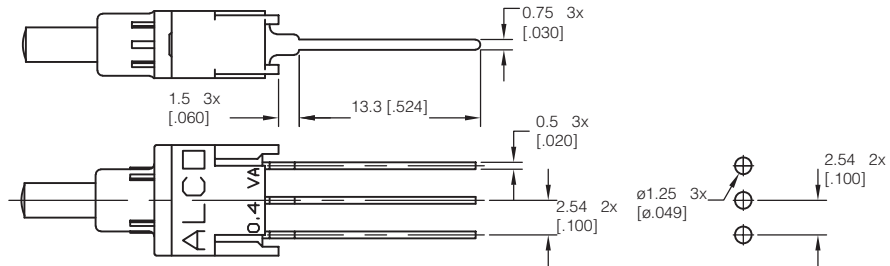

Product key	Bushing	Act.	Poles	Rating	Function	Conn.	Conn.	Plating	Terminals	Btn.	Material	Part Number
TSPD11CGPC004	plain,	length	1	0.4VA	Off (On)	Off	1-3	Gold	pcb	black	RoHS	1571990-1
TSPD11CGPC204	not	.200								red	compliant	1571990-2
TSPD11CGPCV004	threaded	(5.08)								black		1571990-3
TSPD11CGRA004									right angle			1571990-4
TSPD11CGRA204										red		1571990-5
TSPD11CGVRA004									vertical r.a.	black		1-1571990-3
TSPD11CGWW004									wire wrap			1-1571990-4
TSPD11FGPC004					On (On)	1-2	2-3		pcb			1-1571990-5
TSPD11FGPCV004									pcb w brack.			1-1571990-6
TSPD11FGRA004									right angle			1-1571990-7
TSPD11FGVRA004									vertical r.a.			2-1571990-1
TSPDF11CGPC004		flush			Off (On)	Off	1-3		pcb			2-1571990-2
TSPDF11CGRA004									right angle			2-1571990-5
TSPDF11CGVRA004									vertical r.a.			2-1571990-7
TSPDF11FGPC004					On (On)	1-2	2-3		pcb			2-1571990-8
TSPDF11FGRA004									right angle			2-1571990-9

**TP Series, Tiny**

**Features**

- Compact design
- Round or rectangular actuator buttons.
- Vertical or right angle versions



Pushbutton Switches

**Typical performance characteristics**

Contact configuration . . . . . SPST, SPDT, DPDT  
 Contact timing . . . . . Break-Before-Make  
 Contact rating max. . . . . gold: 0.4VA @20VDC or peak AC  
 . . . . . silver: 1A @ 125VAC or 28 VDC resistive  
 Electrical life . . . . . 1 pole2 . . .2 pole  
 . . . . . gold . . . . . 100,000 . . .80,000 cycles  
 . . . . . silver . . . . . 60,000 . . .50,000 cycles  
 Contact resistance, initial . . . . . max.20 mOhms  
 Insulation resistance . . . . . 1,000 MOhms @ 500VDC  
 Dielectric strength . . . . . 1,000 Volts rms @ sea level  
 Actuation force . . . . . 0.5 to 4N (50-400gf)  
 Actuator travel . . . . . momentary .030" (.762)

**Environmental specification**

Operating temperature . . . . . -30°C to +65°C  
 Storage temperature . . . . . -30°C to +65°C  
 Solder heat resistance . . . . . wave solder capable to 265° C

**Material specifications**

Contacts . . . . . copper or brass, gold over nickel finish or silver  
 . . . . . clad with silver over nickel finish  
 Actuator . . . . . thermoplastic  
 Terminals . . . . . brass with gold over nickel or silver over nickel  
 Case . . . . . thermoplastic  
 Frame and support bracket . . . . . steel with tin over copper finish  
 RoHS Directive 2002/95/EC . . . . . compliant

<b>Product key</b>	Typical product key										<b>TP</b>	<b>A</b>		<b>1</b>	<b>1</b>	<b>C</b>	<b>G</b>	<b>PC</b>	<b>0</b>	<b>04</b>																			
<b>Type</b>	TP										Tiny pushbutton series																												
<b>Bushing</b>	blank										square, no bushing																												
	A										round, no bushing																												
	B										round .188 (4.78) dia. bushing not threaded																												
	C										round 10/48 UNS 2B thread																												
	D										.250" (6.35) dia. bushing, not threaded																												
	F										round 1/4-40 UNS 2B thread																												
<b>Actuator</b>	blank										standard																												
	F										flush (available with B and C bushings only)																												
<b>Number of Poles</b>	1					2					single pole										double pole																		
<b>Contact rating</b>	1										0.4VA Gold																												
	2										1.0 A Silver (Silver available only in wire lug and PC termination)																												
<b>Function</b>	single pole										double pole																												
	C					F					M					R																							
	single throw, momentary					double throw, momentary					single throw, momentary					double throw, momentary																							
	CC					FF					dual function C - 2 x single throw, momentary																												
	dual function F - 2 x double throw, momentary																																						
<b>Plating</b>	G										blank																												
	Gold										Silver (Silver available only in wire lug and PC termination)																												
<b>Terminals</b>	blank					RA					VRA																												
	wire lug					right angle					vertical, right angle (available only in single pole)																												
	PC										printed circuit board																												
<b>Button Color</b>	0			2			6			black										red										blue									
<b>Material</b>	04																																						
	RoHS compliant																																						

**TP Series, Tiny (Continued)**

**Bushing**



**blank, square, no bushing**

**printed circuit board**



Single pole

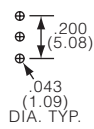
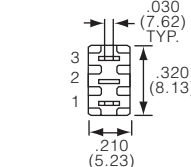
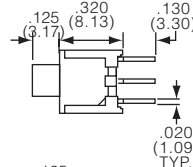
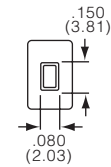

2 x Single pole (dual)

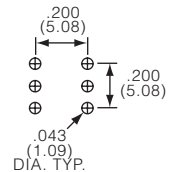
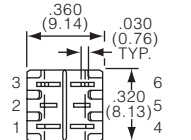
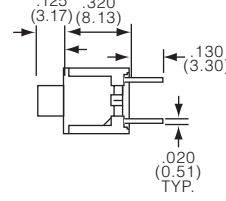
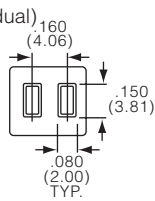

Note: no center terminal on 'C' and 'M' function switch

**right angle**



Single pole

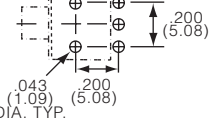
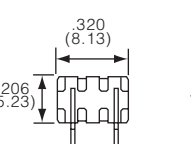
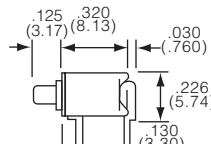
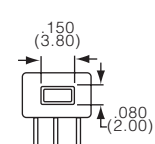

Note: no center terminal on 'C' and 'M' function switch



2 x Single pole (dual)

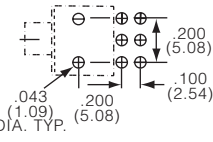
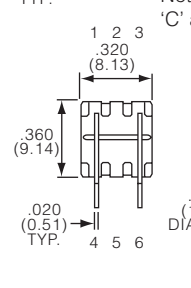
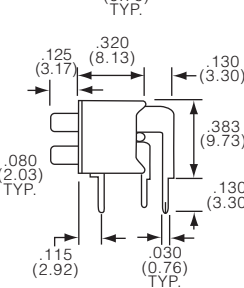
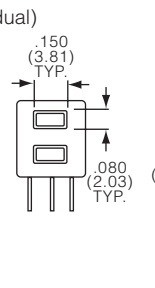

**A, Round, no bushing**

**printed circuit board**



Single pole

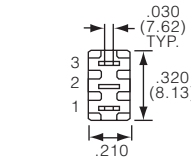
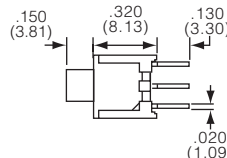
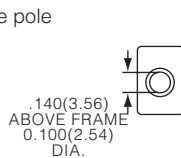

2 x Single pole (dual)

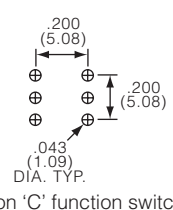
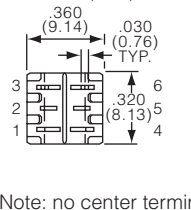
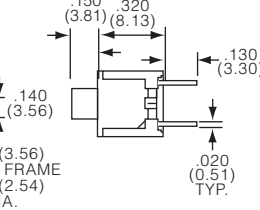
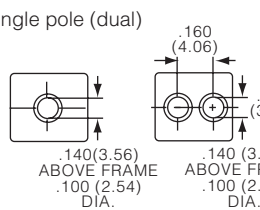

Note: no center terminal on 'C' function switch

**TP Series, Tiny (Continued)**

**right angle**

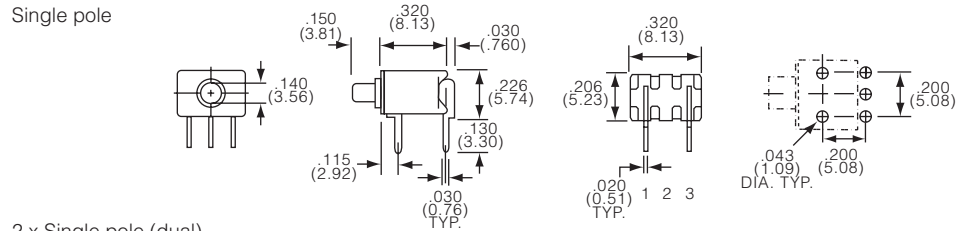

2 x Single pole (dual)

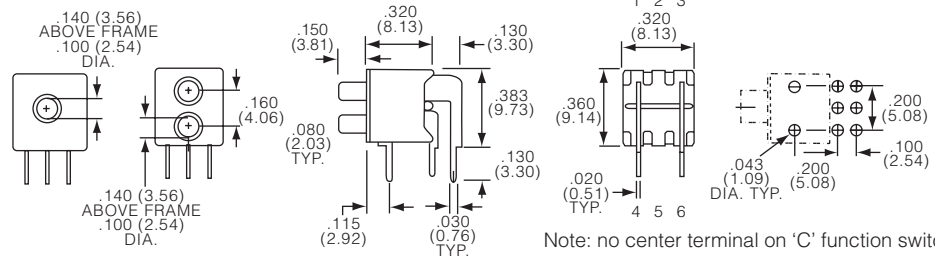

**B, Round .188 (4.78) dia. bushing not threaded**

**printed circuit board**

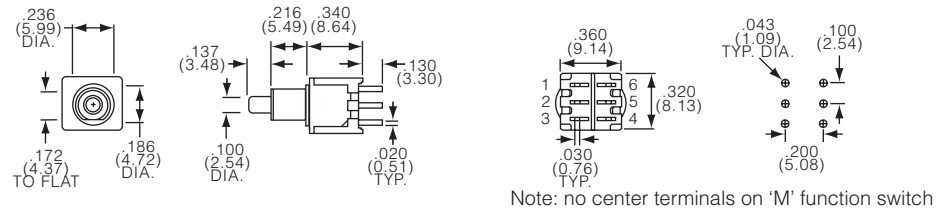
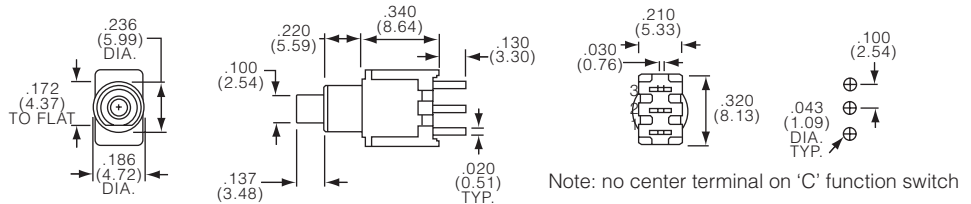

**right angle**

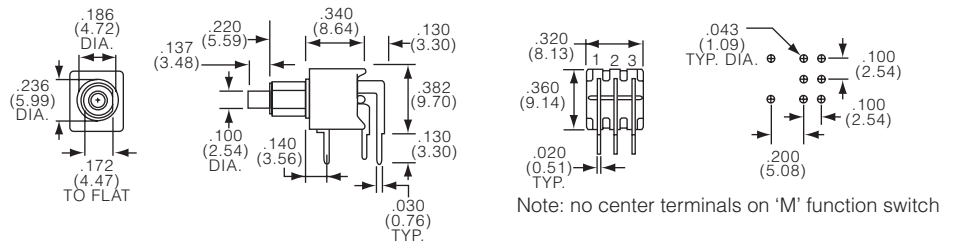
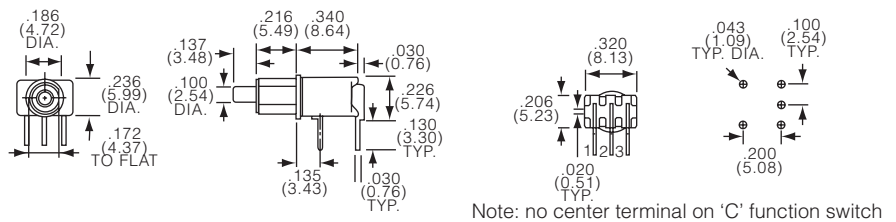



**TP Series, Tiny (Continued)**

**vertical right angle**

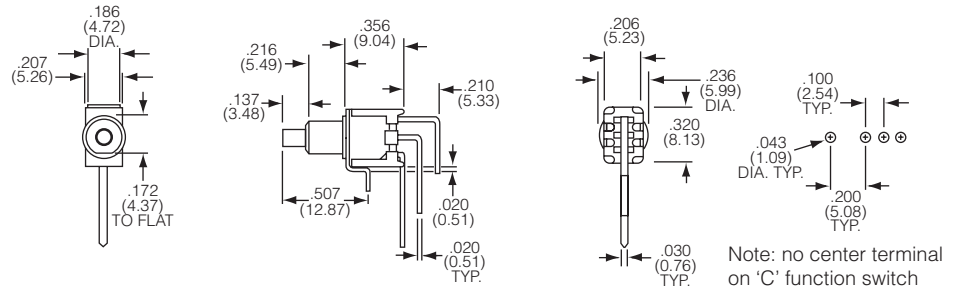

**printed circuit board, flush actuator**

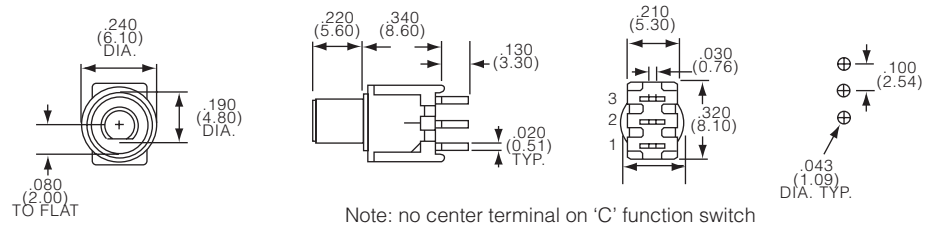

**right angle, flush actuator**

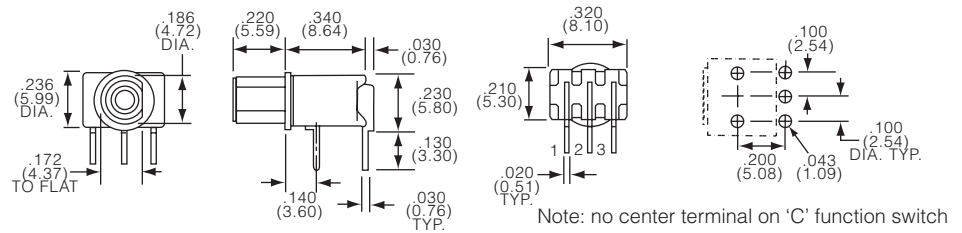

**C, Round 10/48 UNS 2B thread**

**wire lug**

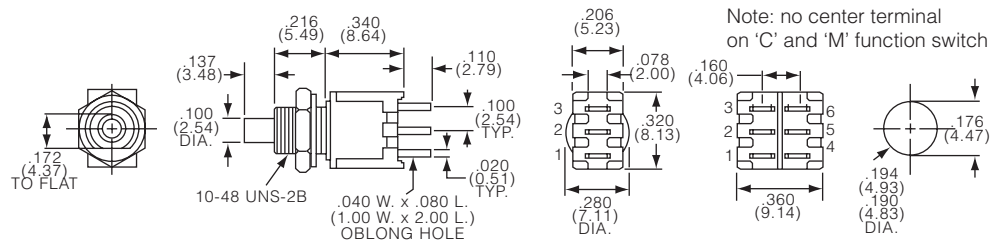

**printed circuit board**

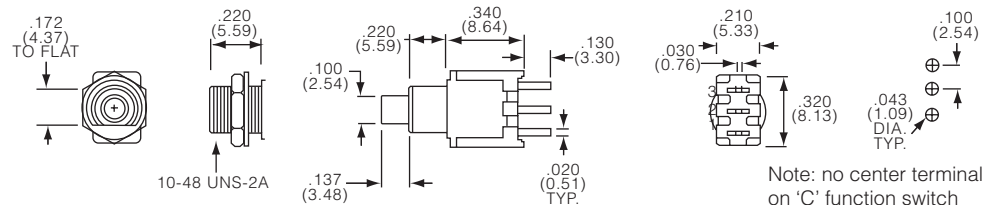

**TP Series, Tiny (Continued)**

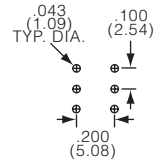
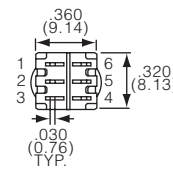
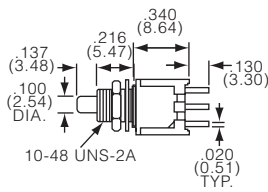

Note: no center terminals on 'M' function switch

**right angle**

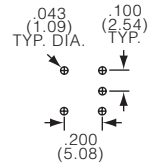
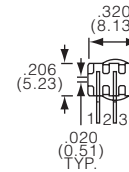
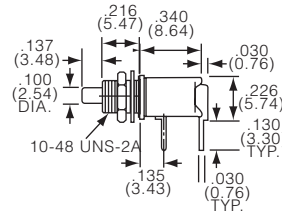

Note: no center terminal on 'C' function switch

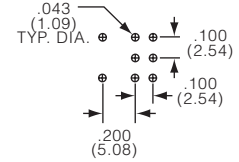
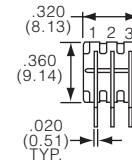
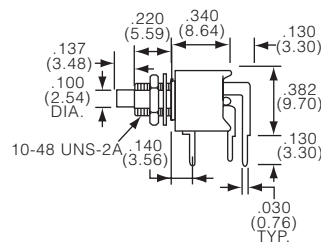

Note: no center terminals on 'M' function switch

**vertical right angle**

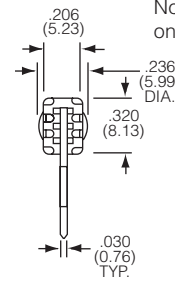
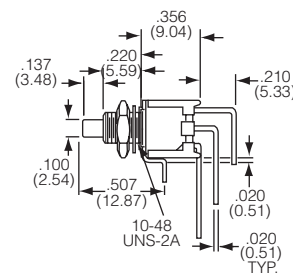
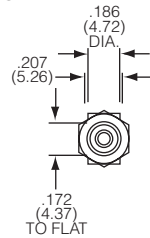

Note: no center terminal on 'C' function switch

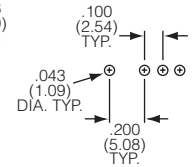

**wire lug, flush actuator**

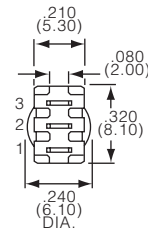
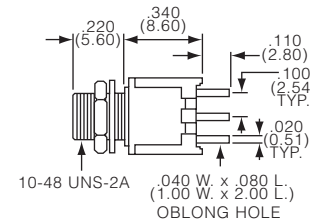
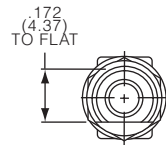

Note: no center terminal on 'C' function switch

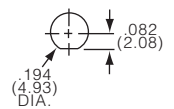

**printed circuit board, flush actuator**

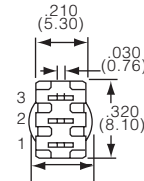
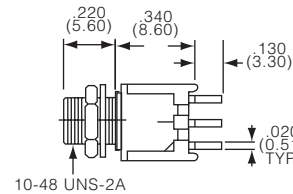
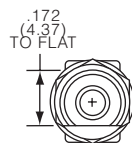

Note: no center terminal on 'C' function switch

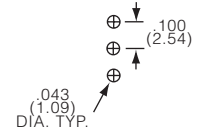

**TP Series, Tiny (Continued)**

**right angle, flush actuator**

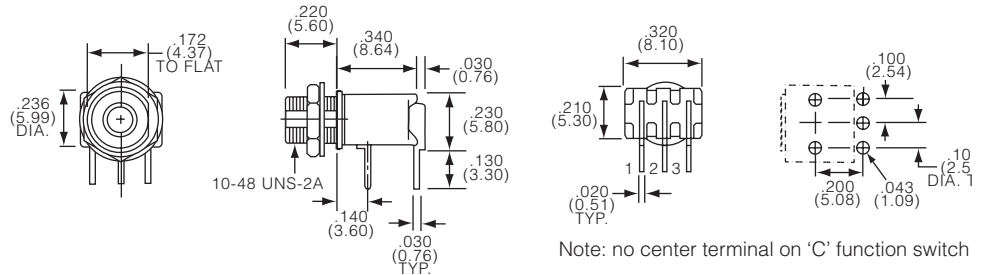

**D, .250" (6.35) dia. bushing, not threaded**

**printed circuit board**

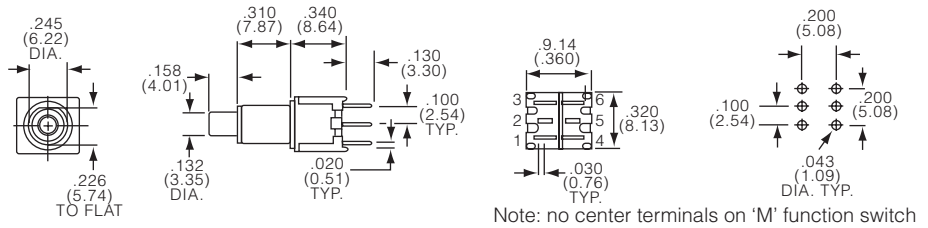
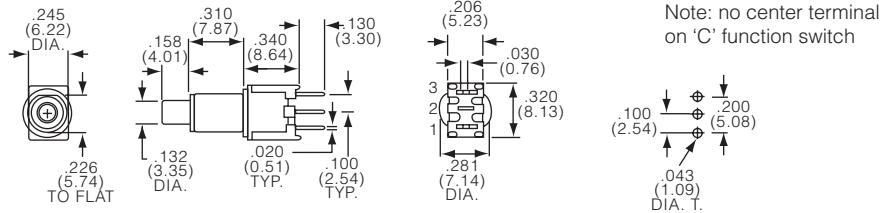

**right angle**

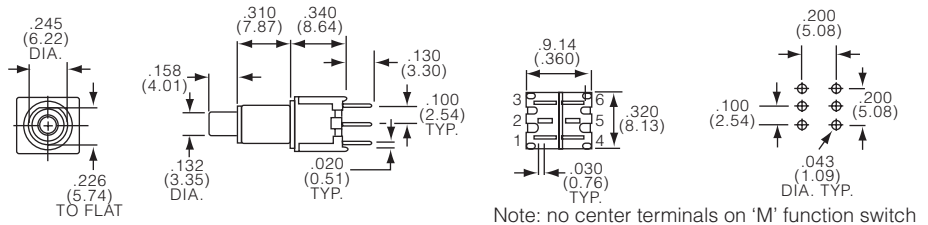
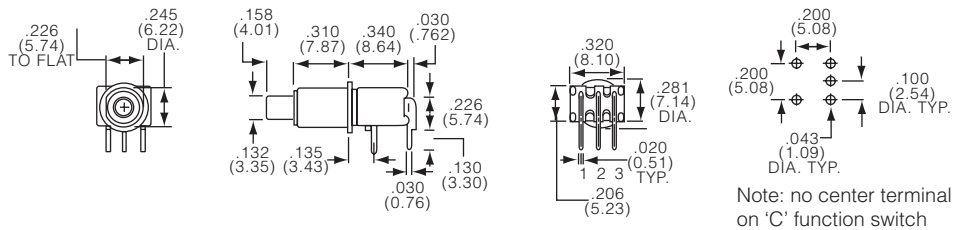

**TP Series, Tiny (Continued)**

**F, Round 1/4-40 UNS 2B thread**

**wire lug**

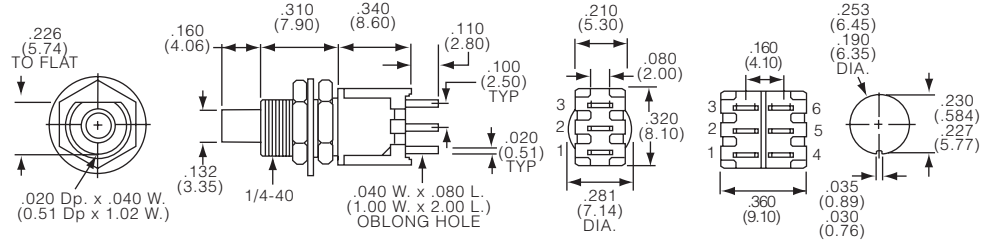

Note: no center terminal on 'C' and 'M' function switch

**printed circuit board**

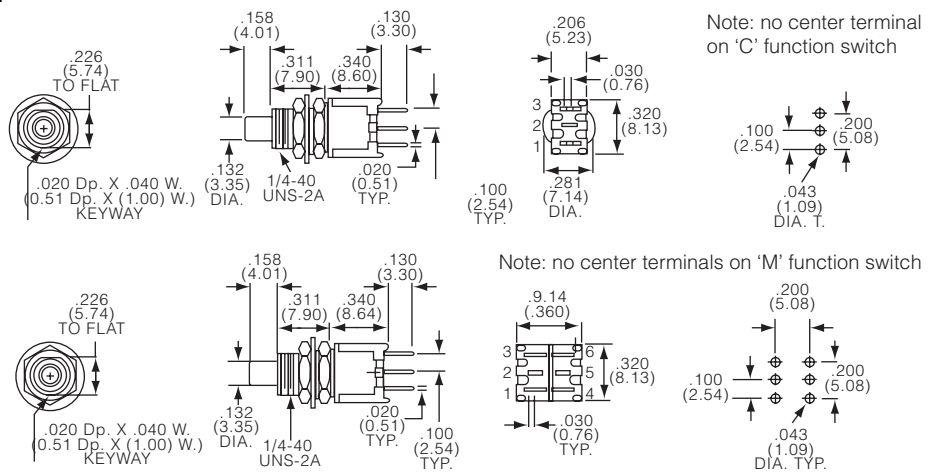

Note: no center terminal on 'C' function switch

Note: no center terminals on 'M' function switch

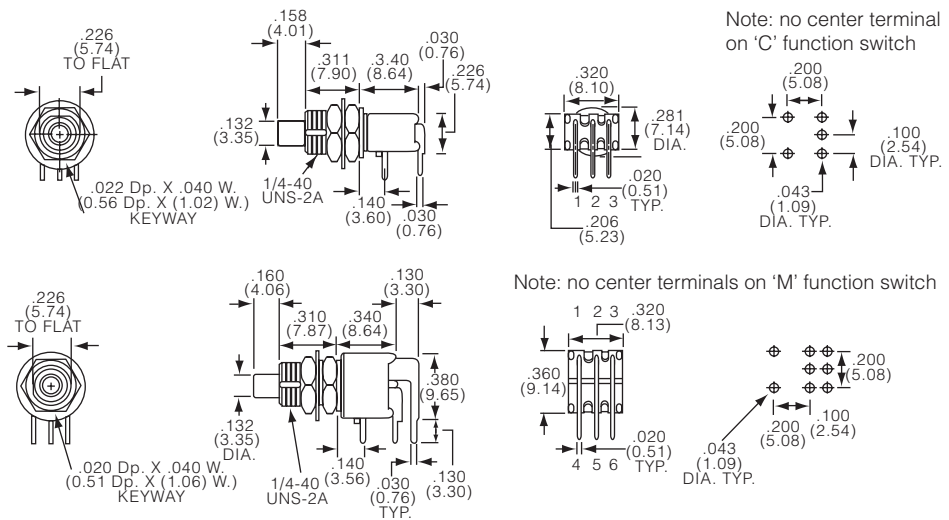

**right angle**



Note: no center terminal on 'C' function switch

Note: no center terminals on 'M' function switch

**TP Series, Tiny (Continued)**

Product key	Bushing	Act.	Poles	Rating	Function			Plating	Terminals	Btn.	Material	Part Number
TP11CGPC004	square	n/a	1	0.4VA	Off-(On)	Off	1-3	Gold	pcb	black	RoHS	1825095-1
TP11CGPC204	no bushing									red	compliant	1825095-2
TP11CGRA004									right angle	black		1825095-3
TP11CGRA204										red		1825095-4
TP11CGRA604										blue		1825095-5
TP11FGPC004					On-(On)	1-2	2-3		pcb	black		1825095-6
TP11FGPC204										red		1825095-7
TP11FGRA004									right angle	black		1825095-8
TP11FGRA204										red		1825095-9
TP11FGRA604										blue		1-1825095-0
TP21CCGRA004			2 (1+1)		Off-(On)	Off	1-3			black		1-1825095-1
TP21CCGRA204										red		1-1825095-2
TP21FFGRA004					On-(On)	1-2	2-3			black		1-1825095-3
<b>TPA11CGPC004</b>	round		1		Off-(On)	Off	1-3		pcb			<b>1825096-1</b>
TPA11CGPC204	no bushing									red		1825096-2
TPA11CGPC604										blue		1825096-3
<b>TPA11CGRA004</b>									right angle	black		<b>1825096-4</b>
TPA11CGRA204										red		1825096-5
TPA11CGRA604										blue		1825096-6
<b>TPA11FGPC004</b>					On-(On)	1-2	2-3		pcb	black		<b>1825096-7</b>
TPA11FGPC204										red		1825096-8
TPA11FGPC604										blue		1825096-9
<b>TPA11FGRA004</b>									right angle	black		<b>1-1825096-0</b>
TPA11FGRA204										red		1-1825096-1
TPA11FGRA604										blue		1-1825096-2
TPA21CCGPC004			2 (1+1)		Off-(On)	Off	1-3, 4-6		pcb	black		1-1825096-3
TPA21CCGRA004									right angle			1-1825096-4
TPA21FFGRA204					On-(On)	1-2, 4-5	2-3, 5-6			red		1-1825096-5
TPA21MGRA004			2		Off-(On)	Off	1-3, 4-6			black		1-1825096-6
<b>TPB11CGPC004</b>	round	std	1				1-3		pcb			<b>1825097-1</b>
TPB11CGPC204	.188 (4.78)									red		1825097-2
<b>TPB11CGRA004</b>	dia								right angle	black		<b>1825097-6</b>
TPB11CGRA204	bushing,									red		1825097-4
TPB11CGVRA004	not								vertical r.a.	black		1825097-8
<b>TPB11FGPC004</b>	threaded				On-(On)	1-2	2-3		pcb			<b>1825097-9</b>
<b>TPB11FGRA004</b>									right angle			<b>1-1825097-1</b>
TPB11FGRA204										red		1-1825097-2
TPB11FGRA604										blue		1-1825097-3
TPB11FGVRA004									vertical r.a.	black		1-1825097-6
<b>TPB21MGPC004</b>			2		Off-(On)	Off	1-3, 4-6		pcb			<b>1-1825097-7</b>
TPB21MGPC204										red		1-1825097-8
TPB21MGRA004									right angle	black		2-1825097-8
TPB21RGRA004					On-(On)	1-2, 4-5	2-3, 5-6					1-1825097-9
TPB21RGRA0EDC04												1825112-1
TPBF11CGRA004		flush	1		Off-(On)	Off	1-3					2-1825097-1
TPBF11FGRA004					On-(On)	1-2	2-3					2-1825097-4
TPBF11FGRA204										red		2-1825097-5

Preferred parts in bold print

**TP Series, Tiny (Continued)**

Pushbutton Switches

Product key	Bushing	Act.	Poles	Rating	Function			Plating	Terminals	Btn.	Material	Part Number
TPC11CGPC004	round	std	1	0.4VA	Off-(On)	Off	1-3	Gold	pcb	black	RoHS compliant	1825098-1
TPC11CGRA004	10/48								right angle			1825098-2
TPC11CGRA204	UNS 2B									red		1825098-3
TPC11CGVRA004	thread								vertical r.a.	black		1825098-4
TPC11FGPC004					On-(On)	1-2	2-3		pcb			1825098-5
TPC11FGRA004									right angle			1825098-6
TPC11FGVRA004									vertical r.a.			1825098-7
TPC11FGVRA204										red		1825098-8
TPC13C004				1.0 A	Off-(On)	Off	1-3	Silver	wire lug	black		1825098-9
TPC13C204										red		1-1825098-0
TPC13CPC004									pcb	black		1-1825098-1
TPC13F004					On-(On)	1-2	2-3		wire lug			1-1825098-2
TPC21MGRA204			2	0.4VA	Off-(On)	Off	1-3, 4-6	Gold	right angle	red		1-1825098-3
TPC21RGPC004					On-(On)	1-2, 4-5	2-3, 5-6		pcb	black		1-1825098-4
TPC23M004				1.0 A	Off-(On)	Off	1-3, 4-6	Silver	wire lug			1-1825098-5
TPC23R204					On-(On)	1-2, 4-5	2-3, 5-6			red		1-1825098-6
TPCF11CGPC004		flush	1	0.4VA	Off-(On)	Off	1-3	Gold	pcb	black		1-1825098-7
TPCF11CGRA004									right angle			1-1825098-8
TPCF11FGRA004					On-(On)	1-2	2-3					1-1825098-9
TPCF13C004				1.0 A	Off-(On)	Off	1-3	Silver	wire lug			2-1825098-0
TPCF13F004					On-(On)	1-2	2-3					2-1825098-1
TPD11CGPC004	.259 (6.35)	n/a		0.4VA	Off-(On)	Off	1-3	Gold	pcb			1825099-1
TPD11CGPC204	dia									red		1825099-2
TPD11CGRA004	bushing,								right angle	black		1825099-3
TPD11CGRA204	not									red		1825099-4
TPD11CGRA604	threaded									blue		1825099-5
TPD11FGPC004					On-(On)	1-2	2-3		pcb	black		1825099-6
TPD11FGRA004									right angle			1825099-7
TPD11FGRA204										red		1825099-8
TPD21MGRA004			2		Off-(On)	Off	1-3, 4-6			black		1825099-9
TPD21RGPC004					On-(On)	1-2, 4-5	2-3, 5-6		pcb			1-1825099-0
TPF11CGPC004	round		1		Off-(On)	Off	1-3					1825100-1
TPF11CGPC204	1/4-40									red		1825100-2
TPF11CGRA004	UNS 2B								right angle	black		1825100-4
TPF11CGRA204	thread									red		1825100-5
TPF11CGRA604										blue		1825100-6
TPF11FGPC004					On-(On)	1-2	2-3		pcb	black		1825100-7
TPF11FGPC204										red		1825100-8
TPF11FGPC604										blue		1825100-9
TPF11FGRA004									right angle	black		1-1825100-1
TPF13C004				1.0 A	Off-(On)	Off	1-3	Silver	wire lug			1-1825100-2
TPF13C204										red		1-1825100-3
TPF13F204					On-(On)	1-2	2-3					1-1825100-4
TPF13F604										blue		1-1825100-5
TPF21MGPC004			2	0.4VA	Off-(On)	Off	1-3, 4-6	Gold	pcb	black		1-1825100-6
TPF21RGRA004					On-(On)	1-2, 4-5	2-3, 5-6		right angle			1-1825100-7
TPF23M004				1.0 A	Off-(On)	Off	1-3, 4-6	Silver	wire lug			1-1825100-8

**TP\_ES Series, Tiny, Process Sealed**

**Features**

- Process and non-process sealed
- Compact design
- Vertical or right angle versions



**Typical performance characteristics**

Contact configuration . . . . . SPST, SPDT, DPDT  
 Contact timing . . . . . Break-Before-Make  
 Contact rating max. . . . . gold: 0.4VA @20VDC or peak AC  
 . . . . . silver: 1A @ 125VAC or 28 VDC resistive  
 Electrical life . . . . . 1 pole2 . . .2 pole  
 . . . . . gold . . . . . 100,000 . . .80,000 cycles  
 . . . . . silver . . . . . 60,000 . . .50,000 cycles  
 Contact resistance, initial. . . . . max.20 mOhms'  
 Insulation resistance . . . . . 1,000 MOhms @ 500VDC  
 Dielectric strength . . . . . 1,000 Volts rms @ sea level  
 Actuation force . . . . . 0.5 to 4N (50-400gf)  
 Actuator travel . . . . . momentary .030" (.762)

**Environmental specification**

Operating temperature . . . . . -30°C to +65°C  
 Storage temperature . . . . . -30°C to +65°C  
 Solder heat resistance . . . . . wave solder capable to 265° C  
 Seal . . . . . versions with process seal, with disposable cap

**Material specifications**

Contacts . . . . . copper or brass, gold over nickel finish or silver  
 . . . . . clad with silver over nickel finish  
 Actuator . . . . . thermoplastic  
 Terminals . . . . . brass with gold over nickel or silver over nickel  
 Case . . . . . thermoplastic  
 Frame and support bracket. . . . . steel with tin over copper finish  
 RoHS Directive 2002/95/EC . . . . . compliant

<b>Product key</b>	Typical product key											
	<b>TP</b>	<b>B</b>		<b>1</b>	<b>1</b>	<b>C</b>	<b>G</b>	<b>RA</b>	<b>ES</b>	<b>0</b>	<b>04</b>	
<b>Type</b>	Tiny pushbutton series											
<b>Bushing</b>												
<b>B</b>	round .188 (4.78) dia. bushing not threaded											
<b>F</b>	round 1/4-40 UNS 2B thread											
<b>Actuator</b>												
<b>blank</b>	standard											
<b>F</b>	flush (available with B bushings only)											
<b>Number of Poles</b>												
<b>1</b>	single pole											
<b>Contact rating</b>												
<b>1</b>	0.4VA Gold											
<b>Function</b>												
<b>C</b>	single throw, momentary											
<b>F</b>	double throw, momentary											
<b>Plating</b>												
<b>G</b>	Gold											
<b>Terminals</b>												
<b>PC</b>	printed circuit board						<b>RA</b> right angle (right angle, ES available with B and C bushing only)					
<b>Process Seal</b>												
<b>ES</b>	process sealed with disposable boot, epoxied double case											
<b>Button Color</b>												
<b>0</b>	black				<b>2</b> red				<b>6</b> blue			
<b>Material</b>												
<b>04</b>	RoHS compliant											

**TP\_ES Series, Tiny, Process Sealed (Continued)**

**Bushing**



**B, Round .188 (4.78) dia. bushing not threaded**

**printed circuit board**



TPB11CGPCES

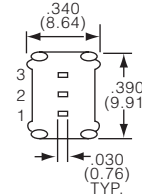
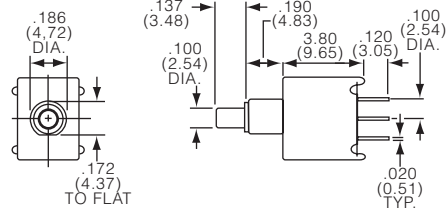

Note: no center terminal on 'C' function switch

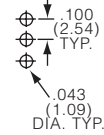

TPB21RGPCES

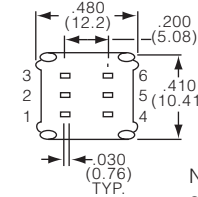
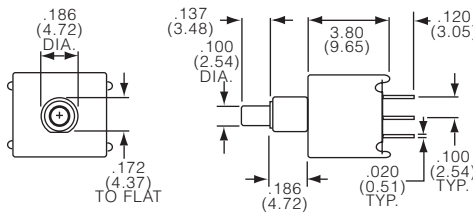

Note: no center terminals on 'M' function switch

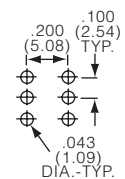

**right angle**



TPB11CGRAES

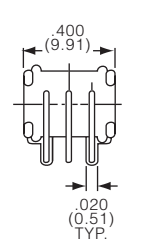
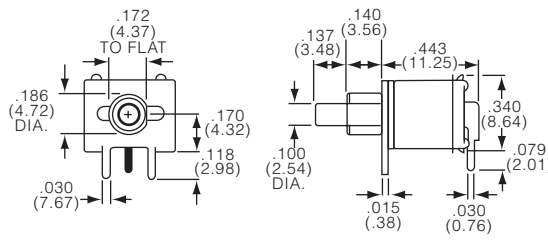

Note: no center terminal on 'C' function switch

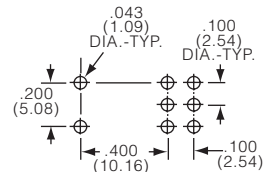
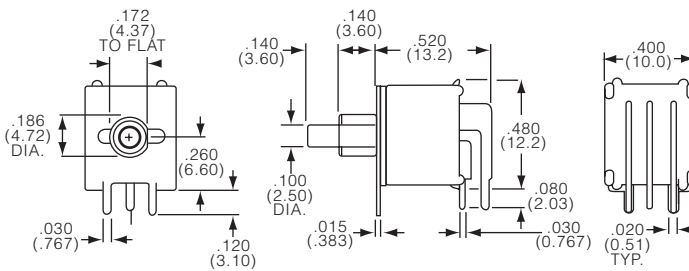
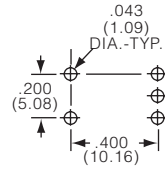

Note: no center terminals on 'M' function switch

**printed circuit board, flush actuator**



TPBF11CGPCES

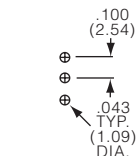
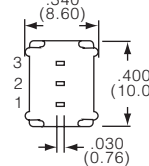
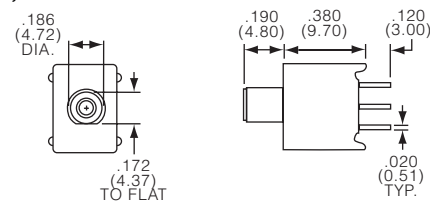

Note: no center terminal on 'C' function switch



**TP\_ES Series, Tiny, Process Sealed (Continued)**

**right angle, flush actuator**

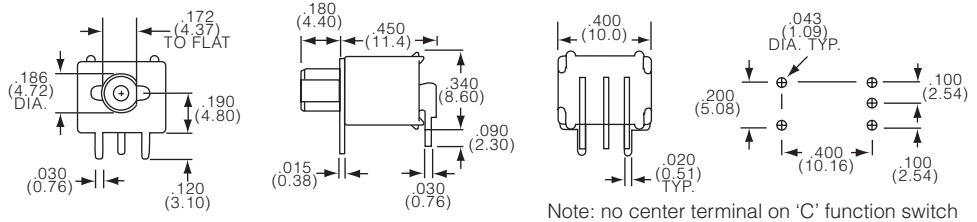

**F, Round 1/4-40 UNS 2B thread**

**printed circuit board**

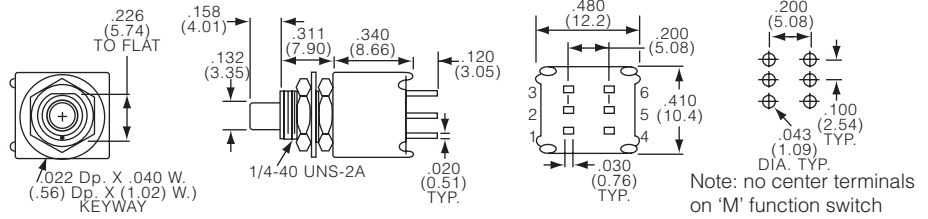
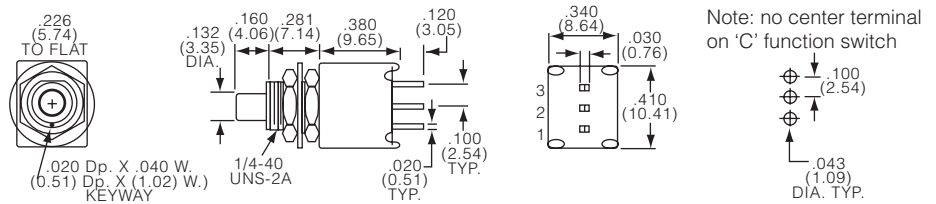

Product key	Bushing	Act.	Poles	Rating	Function	Off	On	Plating	Terminals	Btn.	Material	Part Number
TPB11CGPCES004	round	std	1	0.4VA	Off-(On)	Off	1-3	Gold	pcb	black	RoHS compliant	1825097-3
TPB11CGRAES004	.188 (4.78)								right angle			1825097-5
TPB11CGRAES204	dia									red		1825097-7
TPB11FGPCES204	bushing, not				On-(On)	1-2	2-3		pcb			1-1825097-0
TPB11FGRAES004	threaded								right angle	black		1-1825097-4
TPB11FGRAES604										blue		1-1825097-5
TPBF11CGPCES004		flush			Off-(On)	Off	1-3		pcb	black		2-1825097-0
TPBF11CGRAES004									right angle			2-1825097-2
TPBF11FGPCES004					On-(On)	1-2	2-3		pcb			2-1825097-3
TPBF11FGRAES004									right angle			2-1825097-6
TPF11CGPCES004	1/4-40	std			Off-(On)	Off	1-3		pcb			1825100-3
TPF11FGPCES004	UNS 2B				On-(On)	1-2	2-3					1-1825100-0

**MSPM Series, Magnetic Reed, Long Life, Hermetically Sealed**

**Features**

- Glass to metal hermetic seal
- Magnetic return (no springs)
- Wire lug or pc terminals
- Actuator cap and mounting hardware supplied



Pushbutton Switches

**Typical performance characteristics**

Contact configuration . . . . . SPST  
 Contact timing . . . . . Break-Before-Make  
 Contact rating max. . . . . 1.0 VA (100 mA max. 100 VDC max.)  
 Electrical life . . . . . at 0.1 VA: 5,000,000 cycles  
 . . . . . at 5 VA: 50,000 cycles  
 Contact resistance, initial. . . . . max. 100 mOhms'  
 Insulation resistance . . . . . 1,000 MOhms min.  
 Dielectric strength . . . . . 1,000 Volts rms @ sea level  
 Actuation force . . . . . tactile "keyboard feel" 1.15 to 2 N (115 to 200 gf.)  
 . . . . . "breakaway reducing immediately  
 . . . . . to 0.43 N (43gf.) "follow-through"  
 Actuator travel. . . . . .078" (2.0 mm)

**Environmental specification**

Operating temperature . . . . . -10°C to +80°C  
 Storage temperature . . . . . -10°C to +80°C  
 Solder heat resistance . . . . . hand solder  
 Seal . . . . . glass to metal

**Material specifications**

Contacts . . . . . copper alloy gold plated over nickel  
 Actuator . . . . . polyamide  
 Terminals . . . . . copper alloy gold plated over nickel  
 Case . . . . . steel  
 RoHS Directive 2002/95/EC . . . . . compliant

<b>Product key</b>	Typical product key		<b>MSPM</b>	<b>101</b>	<b>B</b>	<b>1</b>	<b>04</b>
<b>Type</b>	<b>MSPM</b> Pushbutton, magnetic reed, long life, hermetically sealed						
<b>Version</b>	<b>101</b> standard version						
<b>Action</b>	<b>B</b> normally closed, black button <b>C</b> normally open, red cap						
<b>Button</b>	<b>blank</b> with button soft detent <b>S</b> without button audible detent						
<b>Terminals</b>	<b>blank</b> pin	<b>2</b>	pin				
	<b>0</b> pin	<b>1</b>	wire lug				
<b>Material</b>	<b>04</b> RoHS compliant						

**MSPM Series, Magnetic Reed, Long Life, Hermetically Sealed (Continued)**

Button

**blank with button, soft detent, normally open or normally closed**

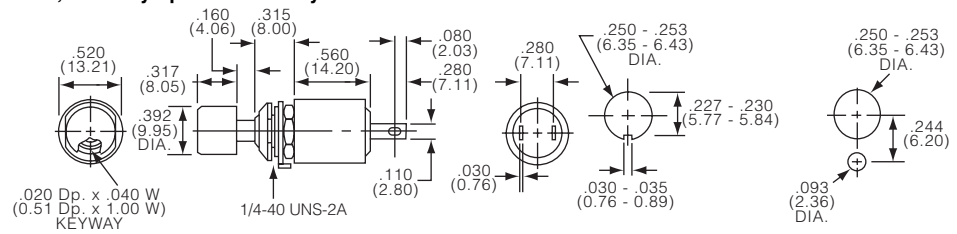

**S without button, audible detent, normally open or normally closed**

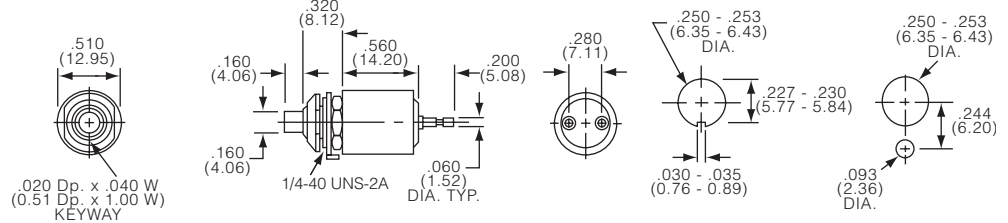

Product key	Action	Button	Terminals	Material	Part Number
MSPM101B004	normally closed	with button	pin	RoHS	1825538-1
MSPM101B104	black button	soft detent	wire lug	compliant	1825538-2
MSPM101C104	normally open				1825538-3
MSPM101C204	red button		pin		1825538-4
MSPM101BS04	normally closed	without button			1825539-1
MSPM101BS104	black button	audible detent	wire lug		1825539-2
MSPM101CS04	normally open		pin		1825539-3
MSPM101CS104	red button		wire lug		1825539-4

**MSPF Series, Front or Rear Mount, 15/32 Bushing**

**Features**

- Versatile front or rear entry mounting
- Relative small depth for 15/32-32 size threaded switch
- Decroitive mounting hardware supplied, others available
- Various button (actuator) colors



Pushbutton Switches

**Typical performance characteristics**

Contact configuration . . . . . SPST and 2 circuit  
 Contact timing . . . . . Break-Before-Make  
 Contact rating max. . . . . 0.5 A @ 125 VAC  
 Electrical life . . . . . 10,000 cycles  
 Contact resistance, initial . . . . . max.100 mOhms  
 Insulation resistance . . . . . 1,000 MOhms min.  
 Dielectric strength . . . . . 1,000 Volts rms @ sea level  
 Actuation force . . . . . 4.5 N (450 gf.)  
 Actuator travel . . . . . .098" (2.5 mm)

**Environmental specification**

Operating temperature . . . . . -20°C to +80°C  
 Storage temperature . . . . . -20°C to +80°C  
 Solder heat resistance . . . . . hand solder  
 Seal . . . . . epoxy sealed terminals

**Material specifications**

Contacts . . . . . copper alloy silver plated  
 Actuator (button) . . . . . thermoplastic  
 Terminals . . . . . copper alloy silver plated  
 Case . . . . . thermoset plastic  
 RoHS Directive 2002/95/EC . . . . . compliant

**Product key**

Typical product key

**MSPF 101 B**

**Type**

**MSPF** Pushbutton switch, front or rear mount, 15/32-32 bushing

**Version**

**101** standard version

**Action**

**B** NC, normally closed, black button  
**C** NO, normally open, red button

**BC** NO & NC, 2 circuit normally open and normally closed

**Button color (BC Action only)**

<b>0</b>	black	<b>6</b>	blue
<b>2</b>	red	<b>9</b>	white

**MSPF Series, Front or Rear Mount, 15/32 Bushing (Continued)**

**Action**



**Codes B, C normally closed or normally open, 1 circuit**



MSPF101B

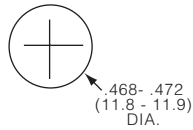
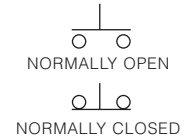
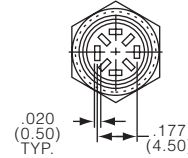
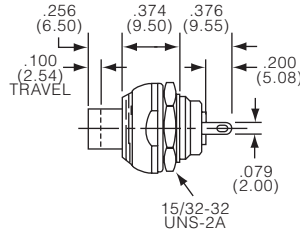
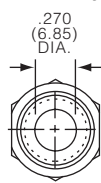

**Code BC normally closed and normally open, 2 circuits**



MSPF101BC

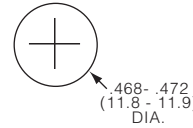
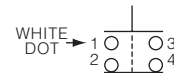
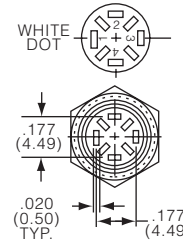
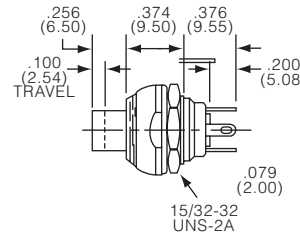
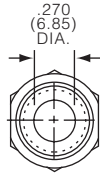

**Mounting**

Application note: Illustration shows versatile front or rear entry usage with hardware supplied

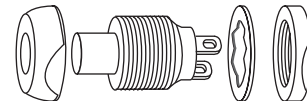

Product key	Action	Type	Button color	Terminals	Part Number
MSPF101B	normally closed	SPST	black	wire lug	8-1437567-8
MSPF101C	normally open		red		9-1437567-3
MSPF101BC0	NO/NC	2 circuit	black		8-1437567-9
MSPF101BC2			red		9-1437567-0
MSPF101BC6			bluw		9-1437567-1
MSPF101BC9			white		9-1437567-2

**MPA103 Series, Panel Mount**

**Features**

- Relatively high current carrying capacity for size of switch
- One piece bushing and shoulder designed to reduce tear off
- Decorative hardware supplied



Pushbutton Switches

**Typical performance characteristics**

Contact configuration	SPST SPDT
Contact timing	Break-Before-Make
Contact rating max.	3A @ 125VAC
Electrical life	10,000 cycles
Contact resistance, initial	20 mOhms max
Insulation resistance	1,000 MOhms min
Dielectric strength	1,000 Volts rms @ sea level
Actuator travel	.098" (2.5mm)
Actuator Force	SPST: 2.8 N (.283)
	SPDT: 4.5 N (.453kg)

**Environmental specification**

Operating temperature	-20°C to +70°C
Storage temperature	-40°C to +80°C
Solder heat resistance	hand solder 420°C max. 3 seconds max.

**Material specifications**

Contacts	copper alloy silver clad
Actuator (button)	phenol resin
Terminals	copper alloy silver plated
Case	thermoset plastic
RoHS Directive 2002/95/EC	compliant

**Product key**

Typical product key **MPA 103 C 04**

<b>Type</b> MPA	Sub-Miniature Pushbutton		
<b>Version</b> 103	standard		
<b>Action</b> B	Normally Closed, momentary	<b>D</b>	Push on/Push off - (tactile)
<b>C</b>	Normally Open, momentary	<b>F</b>	Momentary - (tactile)
<b>Material</b> 04	RoHS compliant		



MPA103C

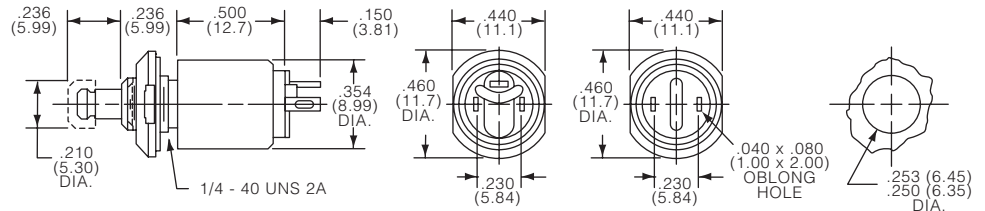

Black cap supplied. Other colors available, order separately (see accessories pushbuttons).

Product key	Action	Type	Terminals	Material	Part Number
MPA103B04	N/C	SPST	Wire Lug	RoHS compliant	1825403-1
MPA103C04	N/O				1825403-2
MPA103D04	Push on/Push off	SPDT			1825404-1
MPA103F04	Momentary				1825404-2

**MSP103 Series, 2.5mm Travel, Panel Mount**

**Features**

- MSP series over-travel design (self cleaning contacts) 3A
- MSPS butt contact design 0.5 A
- One piece bushing and sholder designed to reduce tear off
- Mounting hardware supplied, decorative hardware available



**Typical performance characteristics**

Contact configuration . . . . . SPST  
 Contact timing . . . . . Break-Before-Make  
 Contact rating max. . . . . MSP: 3 A @ 125 VAC  
 . . . . . MSPS: 0.5 A @ 125 VAC  
 Electrical life . . . . . 10,000 cycles  
 Contact resistance, initial . . . . . 100 mOhms max.  
 Insulation resistance . . . . . 1,000 mega ohms min.  
 Dielectric strength . . . . . 1,000 Volts rms @ sea level  
 Actuator travel . . . . . .098" (2.5 mm)

**Environmental specification**

Operating temperature . . . . . -20°C to +80°C  
 Storage temperature . . . . . -20°C to +80°C  
 Solder heat resistance . . . . . hand solder 420°C max. 3 seconds max.

**Material specifications**

Contacts . . . . . copper alloy silver plated  
 Actuator (Button) . . . . . thermoplastic  
 Terminals . . . . . copper alloy silver plated  
 Case . . . . . MPS: phenol resin, MSPS: thermoset plastic  
 RoHS Directive 2002/95/EC . . . . . compliant

<b>Product key</b>		Typical product key		<b>MSP</b>	<b>103</b>	<b>B</b>	<b>04</b>
<b>Type</b>	<b>MSP</b>	Pushbutton switch, 2.5mm travel, panel mount					
<b>Contact</b>	<b>103</b>	3 A @125 VAC					
	<b>S103</b>	0.5 A @125 VAC					
<b>Action/button color</b>	<b>B</b>	NC, normally closed, black actuator					
	<b>C</b>	NO, normally open, red actuator (contact version 103 only)					
	<b>C0</b>	NO, normally open, black actuator					
	<b>C2</b>	NO, normally open, red actuator, long bushing					
<b>Material</b>	<b>04</b>	RoHS compliant		<b>blank</b>	RoHS compliant		

**MSP103 Series, 2.5mm Travel, Panel Mount (Continued)**

**Contact**



**103 3 A contact**



MSP103B

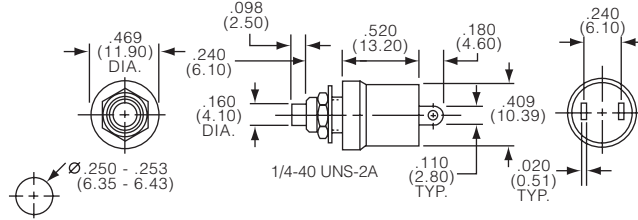

Contact	Action	Bushing len.
103	B	6.00mm (.236)
	C	6.00mm (.236)
	C0	6.00mm (.236)
	C2	9.50mm (.374)

**S103 0.5 A contact**



MSPS103B

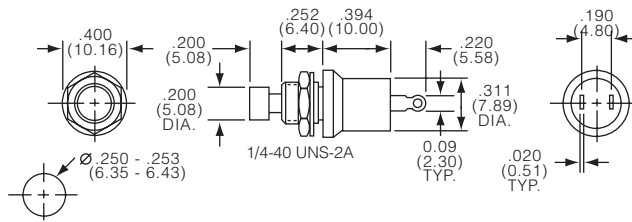

Contact	Action	Bushing len.
S103	B	6.22mm (.245)
	C0	6.22mm (.245)
	C2	6.22mm (.245)

Pushbutton Switches

Product key	Contact	Action	Type	Button color	Terminals	Material	Part Number
MSP103B04	3 A	N/C	SPST	black	wire lug	RoHS	1825516-1
MSP103C04	@125 VAC	N/O		red		compliant	1825516-2
MSP103C004				black			1825516-3
MSP103C204				red			1825516-4
MSPS103B	0.5 A	N/C		black			1437568-5
MSPS103C0	@125 VAC	N/O					1437568-7
MSPS103C2				red			1437568-6



**MPS Series, Snap Action**

**Features**

- Wire lug or pc terminals
- Customer selected actuator cap size and color
- Entire series epoxy sealed terminals
- Actuator guards, decorative hardware, and silicone boot seals available



**Typical performance characteristics**

Contact configuration	SPDT, DPDT
Contact timing	Break-Before-Make
Contact rating max.	3 A @ 125 VAC
Electrical life	50,000 cycles
Contact resistance, initial	10 mOhms max.
Insulation resistance	1,000 MOhms min.
Dielectric strength	1,500 Volts rms @ sea level
Actuation force	200-700 gf
Actuator travel	momentary .04 (1.0mm)
	push on/off .098 (2.5mm)

**Environmental specification**

Operating temperature	-15°C to +70°C
Storage temperature	-15°C to +70°C
Solder heat resistance	wave solder capable to 265°C and hand solder
Seal	epoxy sealed terminals

**Material specifications**

Contacts	phosphor bronze silver clad
Actuator	copper alloy nickel plated
Terminals	copper alloy silver plated
Case	epoxy resin
Frame	stainless steel
Support Bracket	brass tin plated
RoHS Directive 2002/95/EC	compliant

Pushbutton Switches

<b>Product key</b>	Typical product key						<b>MPS</b>	<b>1</b>	<b>03</b>	<b>F</b>	<b>PC</b>	<b>04</b>	
<b>Type</b>	<b>MPS</b> Pushbutton Switches, Snap Action, 3Amp												
<b>Poles</b>	<b>1</b>	1 pole						<b>2</b>	2 poles				
<b>Contact</b>	<b>03</b> 3 A @125 VAC												
<b>Function</b>	<b>D</b> <b>single pole</b> Push-On/Push-Off <b>F</b> momentary						<b>N</b> <b>double pole</b> Push-On/Push-Off <b>R</b> momentary						
<b>Terminals</b>	<b>blank</b> wire lug <b>PC</b> printed circuit board <b>PCV</b> printed circuit board, with support						<b>RA</b> right angle PC terminal <b>WW</b> wire wrap or extended PC						
<b>Material</b>	<b>04</b> RoHS compliant												

**MPS Series, Snap Action (Continued)**

**Function**



Fct.	Poles				
D	1	On	On	3-2	3-1
F	1	On	(On)	3-2	3-1
N	2	On	On	3-2, 6-5	3-1, 6-4
R	2	On	(On)	3-2, 6-5	3-1, 6-4

Off indicates a mechanical position with no electrical connection  
 (On) indicates momentary connection

**Terminals**



**blank wire lug**

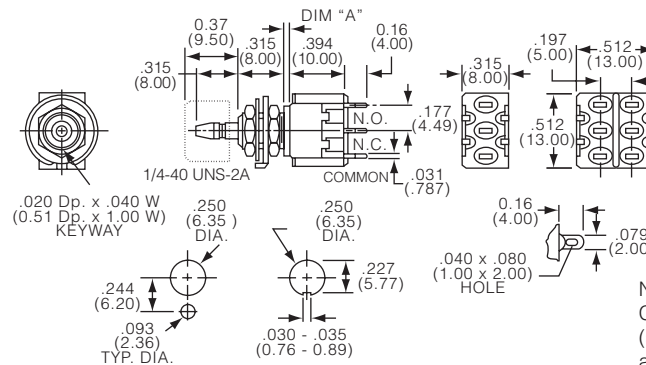

Funct	Action	Dim A
D	1p, push-On/Off	2.54 (.100)
F	1p, momentary	1.016 (.040)
N	2p, push-On/Off	2.54 (.100)
R	2p, momentary	1.016 (.040)

Note: hardware included with switches. Caps not supplied, order separately (see cap model C22 and C23 under accessories)

**PC printed circuit board**

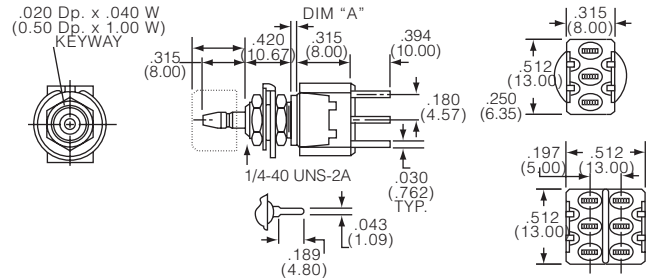

Funct	Action	Dim A
D	1p, push-On/Off	2.54 (.100)
F	1p, momentary	1.016 (.040)
N	2p, push-On/Off	2.54 (.100)
R	2p, momentary	1.016 (.040)

Caps not supplied, order separately (see cap model C22 and C23 under accessories)

**PCV printed circuit board, with support**

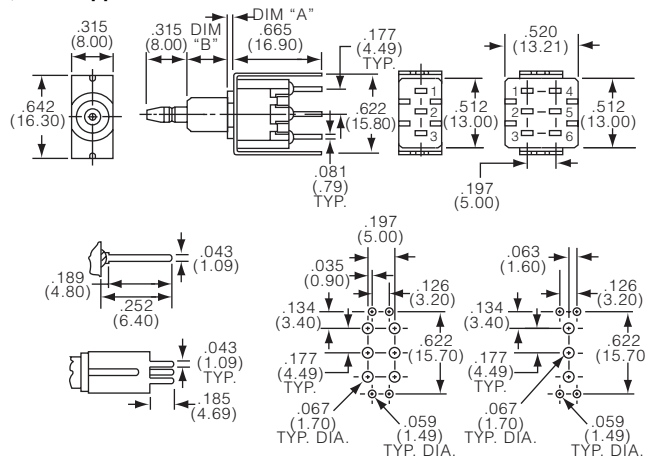

Funct	Dim A	Dim B
D	2.03 (.080)	8.00 (.315)
F	1.01 (.040)	7.49 (.295)
R	1.01 (.040)	7.49 (.295)

Caps not supplied, order separately (see cap model C22 and C23 under accessories)

**MPS Series, Snap Action (Continued)**

**RA right angle, printed circuit board**

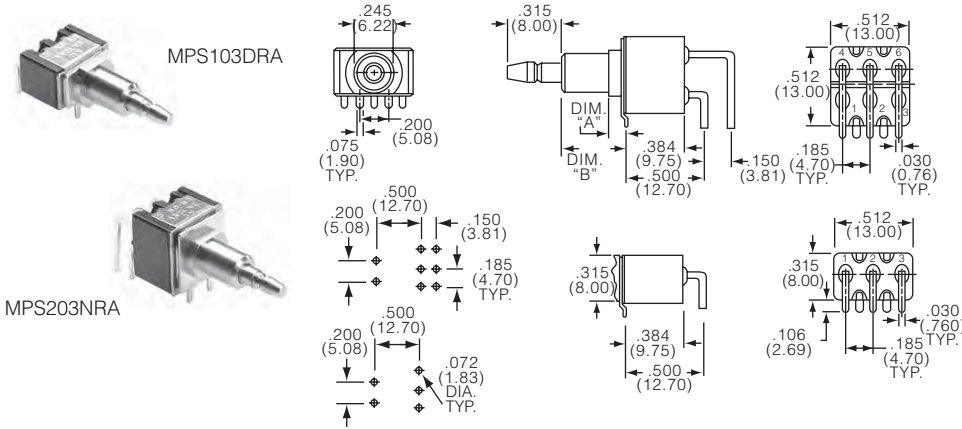

Funct	Dim A	Dim B
D	2.54 (.100)	10.7 (.432)
F	1.52 (.060)	9.24 (.364)
N	2.54 (.100)	10.7 (.432)
R	1.52 (.060)	9.24 (.364)

Caps not supplied, order separately (see cap model C22 and C23 under accessories)

**WW wire wrap, extended pcb**

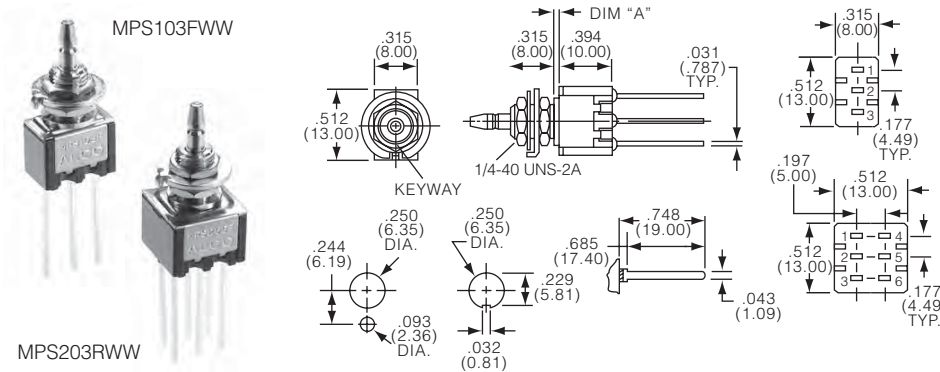

Funct	Action	Dim A
F	1p, momentary	1.016 (.040)
N	2p, push-On/Off	2.54 (.100)
R	2p, momentary	1.016 (.040)

Caps not supplied, order separately (see cap model C22 and C23 under accessories)

Product key	Poles	Contact	Function	Terminals	Material	Part Number
MPS103D04	single pole	3 A @125 VAC	Push-On/Push-Off	solder lug	RoHS compliant	1825092-1
MPS103DPC04				printed circuit board		1825399-1
MPS103DPCV04				PCB, with support		1825401-1
MPS103DRA04				right angle PCB		1825400-1
MPS103F04			momentary	solder lug		1825092-2
MPS103FPC04				printed circuit board	1825399-2	
MPS103FPCV04				PCB, with support	1825401-2	
MPS103FRA04				right angle PCB	1825400-2	
MPS103FWW04			Push-On/Push-Off	wire wrap		1825402-1
MPS203N04				solder lug	1825092-3	
MPS203NPC04				printed circuit board	1825399-3	
MPS203NPCV04				PCB, with support	1825401-3	
MPS203NRA04			momentary	right angle PCB		1825400-3
MPS203R04				solder lug	1825092-4	
MPS203RPC04				printed circuit board	1825399-4	
MPS203RPCV04				PCB, with support	1825401-4	
MPS203RRA04				right angle PCB		1825400-4
MPS203RWW04				wire wrap	1825402-2	

**MP / A / E / G, Green Series**

**Features**

- Wire lug or pC terminals
- Customer selected actuator cap size and color on MPA series
- MPE series sealed to IP65
- Entire series with epoxy sealed terminals
- Actuator guards, decorative hardware, and silicone boot seals available



**Typical performance characteristics**

Contact configuration . . . . . SPDT, DPDT, 3PDT, 4PDT  
 Contact timing . . . . . Break-Before-Make  
 Contact rating max. . . . . 6 A @ 125 VAC, 3 A @ 250 VAC  
 Electrical life . . . . . push on/push off: 30,000 cycles  
 . . . . . momentary: . 20,000 cycles  
 Contact resistance, initial. . . . . 10 mOhms max.  
 Insulation resistance . . . . . 1,000 MOhms min.  
 Dielectric strength. . . . . 1,500Volts rms @ sea level  
 Actuation force . . . . . 4 to 20 N (400 to 2000 gf)  
 Actuator travel . . . . . 3.55 mm

**Environmental specification**

Operating temperature . . . . . -20°C to +80°C  
 Storage temperature . . . . . -40°C to +80°C  
 Solder heat resistance . . . . . wave solder capable to 265°C  
 Seal . . . . . mpe switches IP65

**Material specifications**

Contacts . . . . . copper alloy silver clad  
 Actuator . . . . . brass nickel plated  
 Terminals . . . . . copper alloy gold plated  
 Case . . . . . alkyd polyester (green)UL94 V-O  
 Frame. . . . . stainless steel  
 RoHS Directive 2002/95/EC . . . . . compliant

Pushbutton Switches

**Product key**

Typical product key

**MP A 1 06 D 04**

**Type**

**MP** Green Series Pushbutton Switches, panel mount

**Bushing style**

**A** 1/4-40 3.4mm actuator  
**E** 1/4-40 3.4mm actuator with 'O' rings  
**G** 15/32-32 large actuator

**Number of poles**

**1** single pole **3** 3 poles  
**2** double pole **4** 4 poles

**Rating**

**06** 6 Amp

**Function**

**D** 1 & 3 pole push-on/push-off  
**F** momentary **N** 2 & 4 pole push-on/push-off  
**R** momentary

**Terminals**

**blank** wire lug **PC** printed circuit board

**Material**

**04** RoHS compliant

**MP / A / E / G, Green Series (Continued)**

Bushing style A

single & double pole



MPA106D



MPA206N

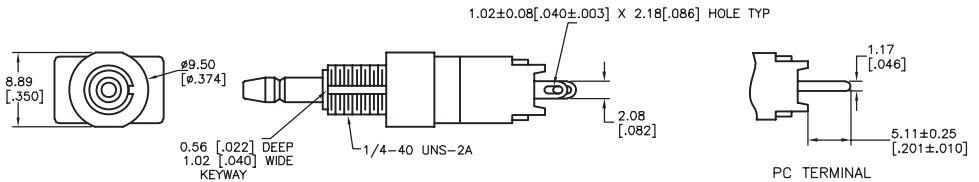
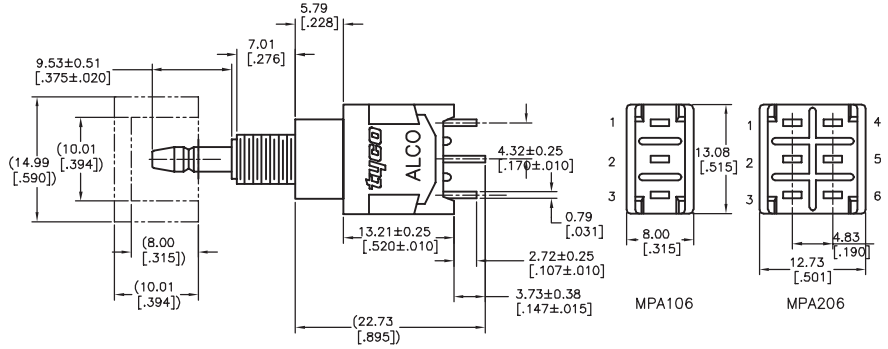

3 & 4 pole



MPA306D



MPA406N

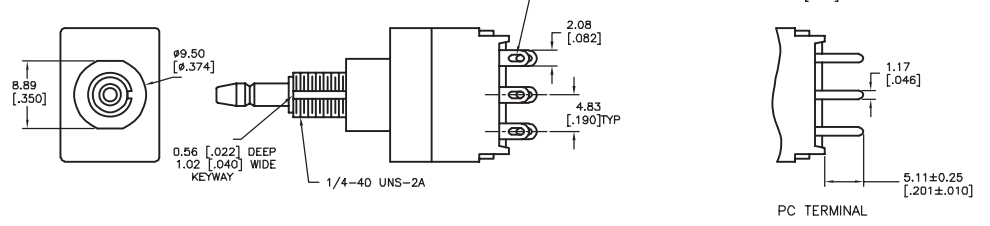
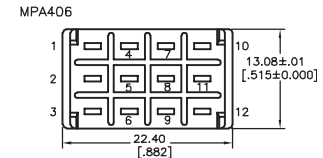
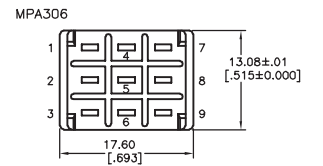
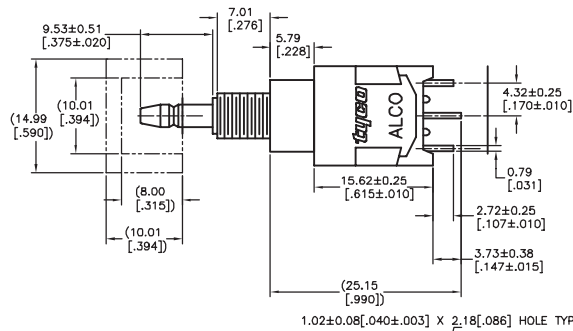

mounting

RECOMMENDED HOLE LAYOUT TO PREVENT ROTATION

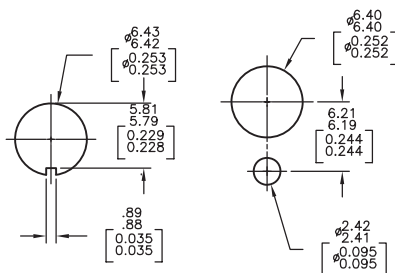

PC BOARD LAYOUT PC TERMINALS ONLY

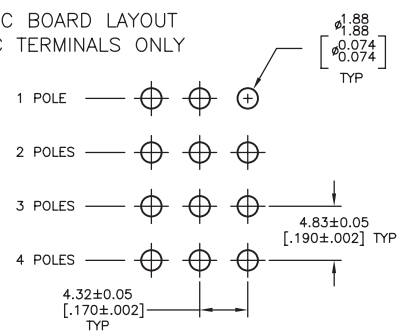

**MP / A / E / G, Green Series (Continued)**

**Bushing style E**



**single & double pole**



MPE106D



MPE206N

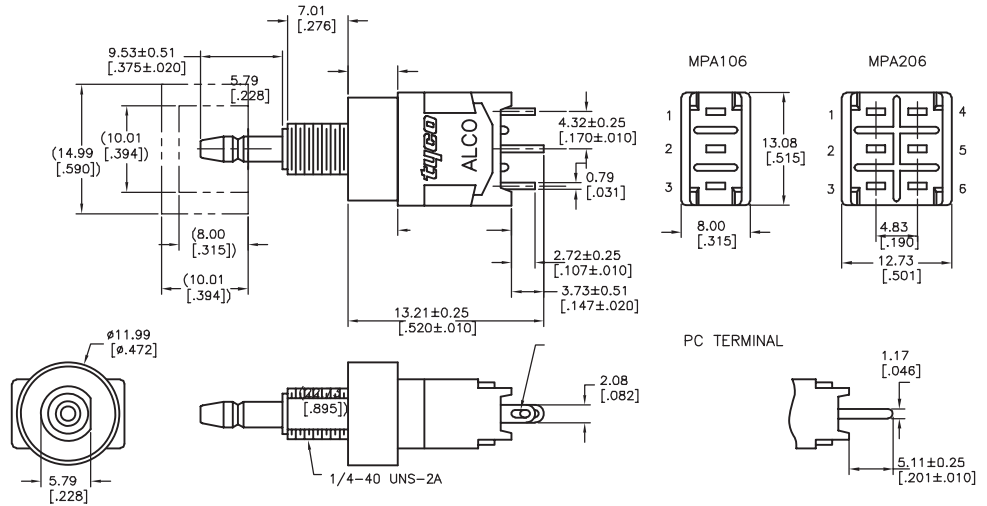

**3 & 4 pole**



MPE306F



MPE406N

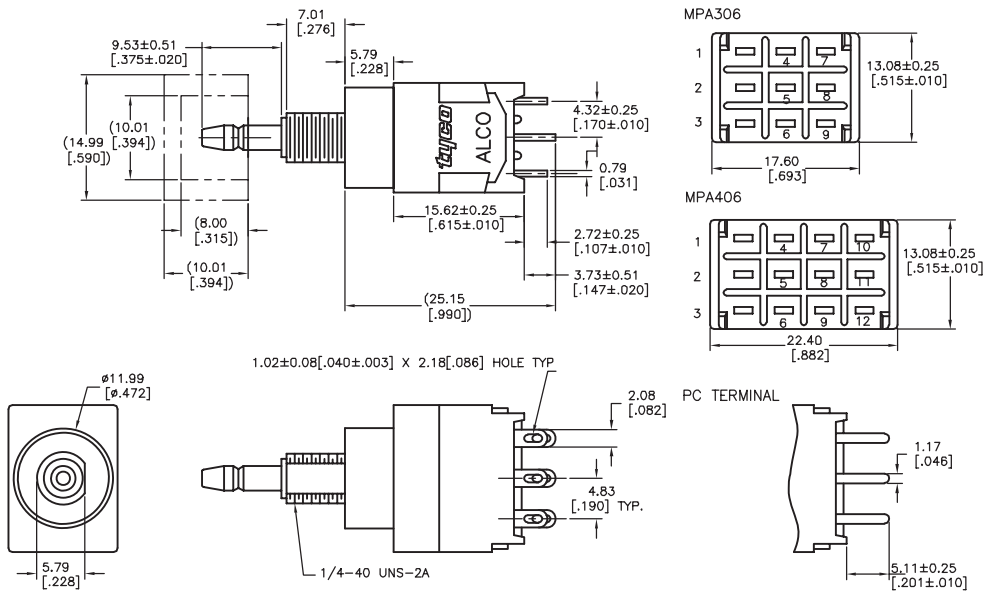

**mounting**

**RECOMMENDED HOLE LAYOUT TO PREVENT ROTATION**

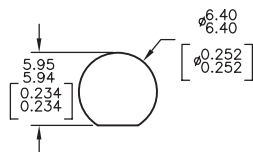

**PC BOARD LAYOUT PC TERMINALS ONLY**

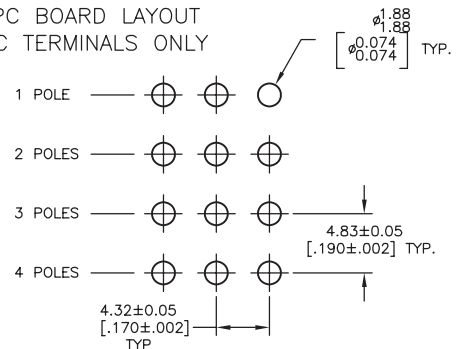

**MP / A / E / G, Green Series (Continued)**

Bushing style G

single & double pole



MPG106D



MPG206NPC

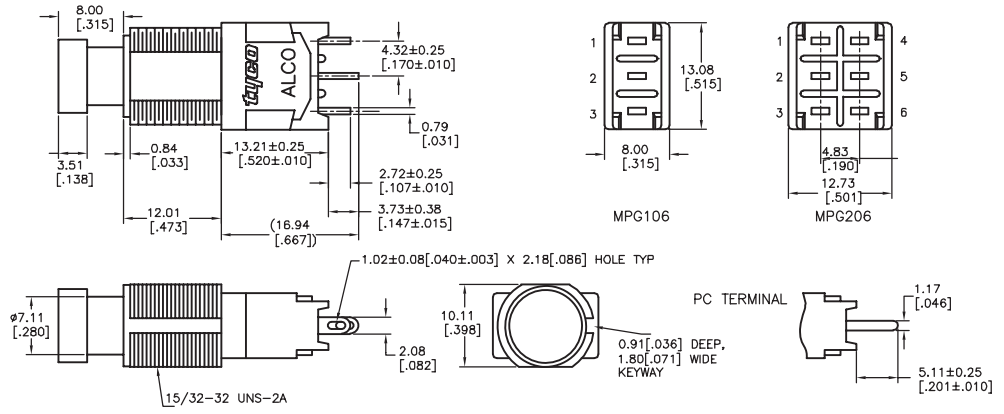

3 & 4 pole



MPG306D



MPG406N



mounting

RECOMMENDED HOLE LAYOUT TO PREVENT ROTATION

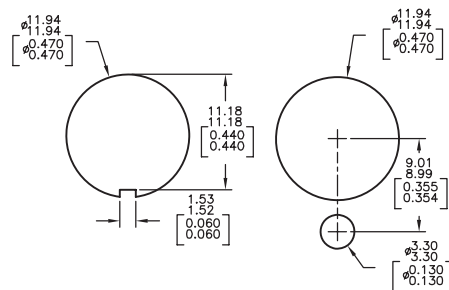





PC BOARD LAYOUT PC TERMINALS ONLY





**MP / A / E / G, Green Series** (Continued)

Function 

Fct.	Poles				
D	1	On	On	2-1	2-3
F	1	On	(On)	2-1	2-3
N	2	On	On	2-1, 5-4	2-3, 5-6
R	2	On	(On)	2-1, 5-4	2-3, 5-6
D	3	On	On	2-1, 5-4, 8-7	2-3, 5-6, 8-9
F	3	On	(On)	2-1, 5-4, 8-7	2-3, 5-6, 8-9
N	4	On	On	2-1,5-4,8-7,11-10	2-3,5-6,8-9,11-12
R	4	On	(On)	2-1,5-4,8-7,11-10	2-3,5-6,8-9,11-12

Off indicates a mechanical position with no electrical connection  
(On) indicates momentary connection

Pushbutton Switches

Product key	Bushing	No. of poles	Rating	Function	Terminals	Material	Part Number
<b>MPA106D04</b>	1/4-40	single pole	6 Amps	push-on/push-off	wire lug	RoHS compliant	<b>1825040-1</b>
<b>MPA106F04</b>	3.4mm			momentary			<b>1825040-2</b>
<b>MPA106DPC04</b>	actuator			push-on/push-off	pcb		<b>1825040-3</b>
<b>MPA106FPC04</b>				momentary			<b>1825040-4</b>
<b>MPA206N04</b>		double pole		push-on/push-off	wire lug		<b>1825040-5</b>
<b>MPA206NPC04</b>					pcb		<b>1825040-6</b>
<b>MPA206R04</b>				momentary	wire lug		<b>1825040-7</b>
<b>MPA206RPC04</b>					pcb		<b>1825040-8</b>
<b>MPA306D04</b>		3 poles		push-on/push-off	wire lug		<b>1825040-9</b>
<b>MPA306F04</b>				momentary			<b>1-1825040-0</b>
<b>MPA406N04</b>		4 poles		push-on/push-off			<b>1-1825040-1</b>
<b>MPA406R04</b>				momentary			<b>1-1825040-2</b>
<b>MPE106D04</b>	1/4-40	single pole		push-on/push-off			<b>1825041-1</b>
<b>MPE106F04</b>	3.4mm			momentary			<b>1825041-2</b>
<b>MPE206N04</b>	actuator	double pole		push-on/push-off			<b>1825041-3</b>
<b>MPE206R04</b>	with 'O' ring			momentary			<b>1825041-4</b>
<b>MPE306D04</b>		3 poles		push-on/push-off			<b>1825041-5</b>
<b>MPE306F04</b>				momentary			<b>1825041-6</b>
<b>MPE406N04</b>		4 poles		push-on/push-off			<b>1825041-7</b>
<b>MPE406R04</b>				momentary			<b>1825041-8</b>
<b>MPG106D04</b>	15/32-32	single pole		push-on/push-off			<b>1825042-1</b>
MPG106DPC04	large			push-on/push-off	pcb		1825042-2
<b>MPG106F04</b>	actuator			momentary	wire lug		<b>1825042-3</b>
MPG106FPC04					pcb		1825042-4
<b>MPG206N04</b>		double pole		push-on/push-off	wire lug		<b>1825042-5</b>
<b>MPG206NPC04</b>					pcb		<b>1825042-6</b>
<b>MPG206R04</b>				momentary	wire lug		<b>1825042-7</b>
<b>MPG206RPC04</b>					pcb		<b>1825042-8</b>
<b>MPG306D04</b>		3 poles		push-on/push-off	wire lug		<b>1825042-9</b>
<b>MPG306F04</b>				momentary			<b>1-1825042-0</b>
<b>MPG406N04</b>		4 poles		push-on/push-off			<b>1-1825042-1</b>
<b>MPG406R04</b>				momentary			<b>1-1825042-2</b>

Preferred parts in bold print



**A60 Series, THT**

**Features**

- Approved construction
- 2 different actuator lengths
- 2 Change-over contacts
- Versions with sealed base available



**Typical performance characteristics**

Contact configuration	DPDT
Contact timing	Break-before-Make timing
Contact rating max	0,5 A @ 60 V AC/DC
Electrical life	>10,000 cycles (200 mA @ 15 VAC)
Mechanical life	20,000 cycles
Contact resistance	max 40 mOhm
Insulation resistance	min. 10,000 MOhm
Dielectric strength	500 VAC
Actuator travel	momentary 3.3 mm

**Environmental specification**

Operating temperature	-25°C to +85°C
Storage temperature	-25°C to +85°C
Solder heat resistance	265°C/ 10s wave

**Material specifications**

Base	pc-gf
Cover	psu
Contacts	copper alloy gold finish
Terminals	copper alloy tin finish
actuator	pom
RoHS compliance	compliant

**Dimensions**

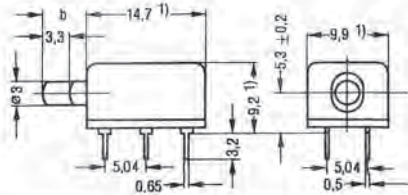

dimension b = 5.4 mm or 9.4 mm

**A60 Series, THT (Continued)**

**Function, Mounting**



Product key	Actuator	Sealed base	Material	Part Number
C42315A60A3	standard	no	RoHS	1393683-1
C42315A60A4	long	no	compliant	1393683-2
C42315A60A13	standard	yes		1393683-3
C42315A60A14	long	yes		1393683-4

**Accessories**



**Caps**



Product key	for	Color	Diam A	Length B	Material	Part Number	
C50	MPA3	black	4.95 (.195)	3.05 (.120)	RoHS compliant	6-1437627-2	
C52		red				6-1437627-3	
C55		green				6-1437627-5	
C59		white				6-1437627-6	
C80		black				7.87 (.310)	4.06 (.160)
C82	red	6-1437627-8					
C85	green	6-1437627-9					
C89	white	7-1437627-0					
C9004	MPG	black	9.00 (.354)	3.47 (.137)	1825070-1		
C9204		red			1825070-2		
C9604		orange			1825070-3		
C9904		yellow			1825070-4		
C22004	MPS/MSPM MPE/MPA6	black	10.2 (.402)	8.00 (.315)	1825068-1		
C22204		red			1825068-2		
C22304		orange			1825068-3		
C22404		yellow			1825068-4		
C22504		green			1825068-5		
C22604		blue			1825068-6		
C22904		white			1825068-7		
C23004		black			15.2 (.600)	10.0 (.394)	1825069-1
C23204		red					1825069-2
C23304		orange					1825069-3
C23404		yellow					1825069-4
C23504		green					1825069-5
C23604		blue					1825069-6
C23904		white					1825069-7

**Guards**

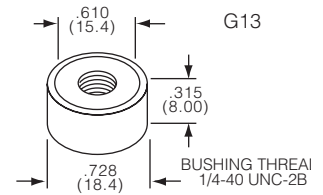

Product key	Thread	Color	Texture	Material	Part Number
G11A	10-48	natural Aluminum	smooth	RoHS compliant	7-1437627-6
G11B		black Aluminum			7-1437627-7
G11C		chrome brass			7-1437627-8
G11KA	1/4-40	natural Aluminum	straight knurl		7-1437627-9
G11KB		black Aluminum			8-1437627-0
G12A		natural Aluminum			8-1437627-1
G12B	black Aluminum	8-1437627-2			
G12C	chrome brass	8-1437627-3			
G12KA	15/32-32	natural Aluminum	straight knurl		8-1437627-4
G12KB		black Aluminum			8-1437627-5
G12KC		chrome brass			8-1437627-6
G13A	15/32-32	natural Aluminum	smooth		8-1437627-7
G13B		black Aluminum			8-1437627-8
G13C		chrome brass			8-1437627-9
G13KA	15/32-32	natural Aluminum	straight knurl		9-1437627-0
G13KB		black Aluminum			9-1437627-1
G13KC		chrome brass			9-1437627-2
G15	15/32-32		smooth		9-1437627-3

**Accessories (Continued)**

**Decorative Hardware**

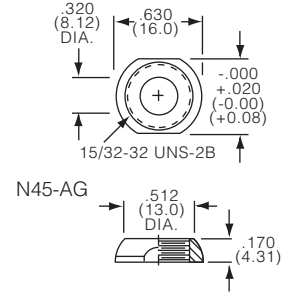
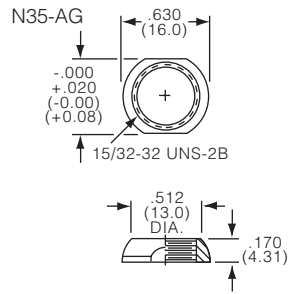
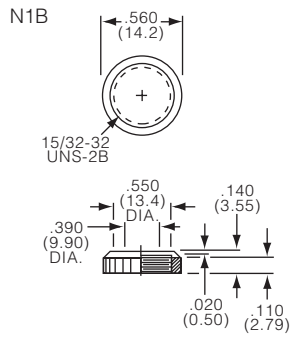

Product key	Thread	Material	Part Number
N1B04	15/32-32	RoHS compliant	1825622-2
N3504			1825621-2
N4504			1825623-3

**BP Series Boot Seals**

**Features**

- One piece design, nut over molded "bonded" to silicone boot element
- Silicone rubber eliminates cure dates
- Protects against moisture, oil, dirt, dust, most solvents, and some acids



**Environmental specification**

Operating temperature ..... -65°C to 265°C

**Material specifications**

Boot material ..... silicone rubber  
 Threaded nut material, and finish..... brass nut, black oxide finish  
 RoHS Directive 2002/95/EC ..... compliant

**Product key**

Typical product key

**BP 1532 0 04**

<b>Type</b>		BP Pushbutton boot seals	
<b>Nut thread</b>		1048 10-48 UNS 2-B A1440 1/4-40 UNS 2-B 1440 1/4-40 UNS 2-B 1532 15/32-32 UNS 2-B 2010 1/4-40 UNS 2B with knurl	
<b>Color</b>		0 black                      2 red                      8 gray	
<b>Material</b>		04 RoHS compliant	

**Nut thread**



**1048 10-48 UNS 2-B, suited for MSPF and MPG series switches**



BP1048004

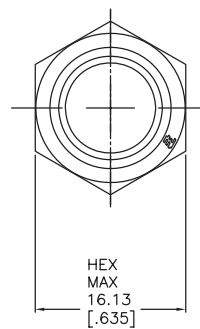
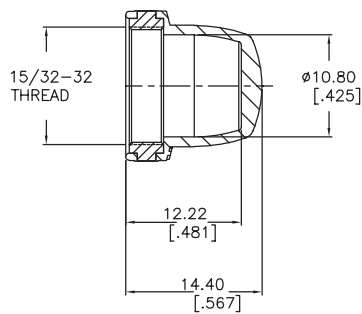

**A1440 1/4-40 UNS 2-B, suited for MSPMBS, MSPMCS, MSP3, MPA3, TP series switches**



BPA1440004

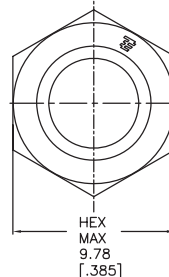
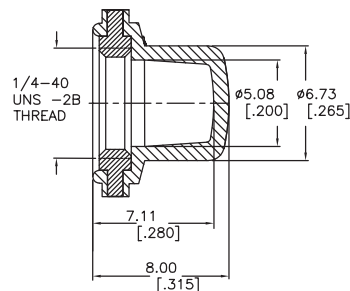

**BP Series Boot Seals (Continued)**

Pushbutton Switches

**1440 1/4-40 UNS 2-B, suited for MSPM,MPA3,MPS and TP series switches**



BP1440004

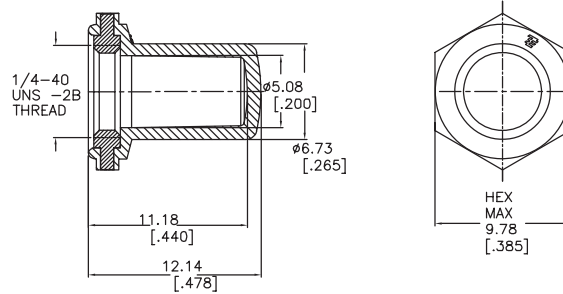

**1532 15/32-32 UNS 2-B, suited for TP series switches**



BP1532004

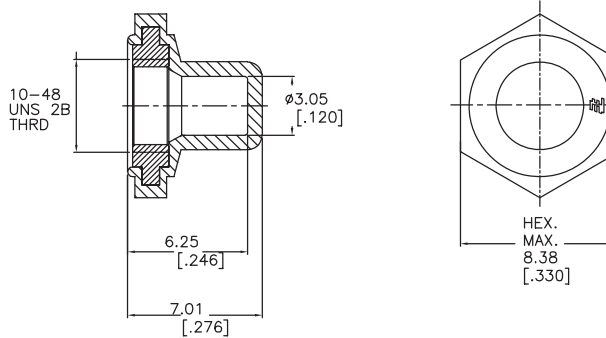

**2010 1/4-40 UNS 2B with knurl, suited for MSPM,MSP3,MPA3, and TP series switches**



BP201004

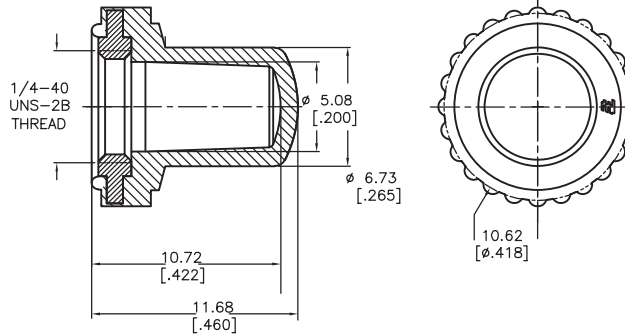

Product key	Used on switch type	Nut thread	Color	Material	Part Number
<b>15/32-32 Pushbutton Boot Seals</b>					
BP1532004	MSPF and MPG series	15/32-32	black	RoHS compliant	1825603-1
BP1532204			red		1825603-2
BP1532804			gray		1825603-3
<b>1/4-40 Pushbutton Boot Seals</b>					
BPA1440004	MSPMBS,MSPMCS,MSP3,MPA3,TP series	1/4-40	black	RoHS compliant	1825604-1
BPA1440204			red		1825604-2
BPA1440804			gray		1825604-3
BP1440004	MSPM,MPA3,MPS and TP series		black		1825610-1
BP1440204			red		1825610-2
BP1440804			gray		1825610-3
<b>10-48 Pushbutton Boot Seals</b>					
BP1048004	TP series	10-48	black	RoHS compliant	1825615-1
BP1048204			red		1825615-2
<b>1/4-40 Knurled Pushbutton Boot Seal</b>					
BP201004	MSPM,MSP3,MPA3, and TP series	1/4-40	black	RoHS compl.	1825617-2

**BP Series Panel Seal**

**Features**

- Unique design allows 1/4-40 threaded switch on almost any panel thickness
- Fits in a 15/32" (11.9mm) or 1/2" (12.7mm) diameter panel hole.
- Multiple cap colors available



**Material specifications**

Cap material . . . . . silicone rubber  
 Housing material . . . . . ABS thermoplastic black  
 Jam nut, spacer material & finish . . . . . brass nickel plated  
 RoHS Directive 2002/95/EC . . . . . compliant

<b>Product key</b>	Typical product key					<b>BP</b>	<b>M</b>	<b>1532</b>	<b>0</b>	<b>04</b>
<b>Type</b>	Pushbutton switch panel seal									
<b>BP</b>										
<b>Switch series</b>										
<b>M</b>	MPA Series									
<b>T</b>	TP & TP_ES Tiny Series									
<b>Nut thread</b>										
<b>1532</b>	15/32-32 UNS 2-A									
<b>Color</b>										
<b>0</b>	black	<b>2</b>	red	<b>8</b>	gray					
<b>Material</b>										
<b>04</b>	RoHS compliant									

**BP Series Panel Seal (Continued)**

Switch series



**BPM BPM Series panel seal, suited for MPA series switches**



BPM1532004

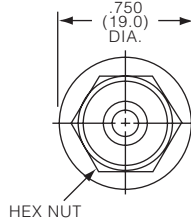

For use with Miniature Pushbutton  
The BPM seal adaptor accommodates all Tyco MPA Series of pushbutton switches utilizing the 1/4-40 threaded bushing.

**BPT BPT Series panel seal, suited for TP Tiny series switches**



BPT1532804

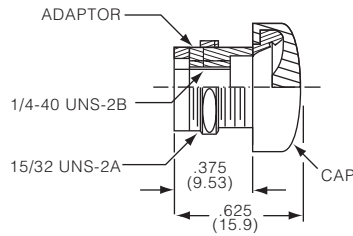
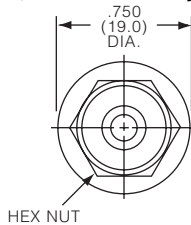

For use with Tiny Series TPF Pushbutton  
The BPT seal adaptor accommodates all Tyco TPF Series Tiny Pushbutton switches utilizing the 1/4-40 threading bushing.

Pushbutton Switches

Product key	Used on switch type	Color	Material	Part Number
BPM1532004	MPA series	black	RoHS	1825618-1
BPM1532204		red	compliant	1825618-2
BPM1532804	TP Tiny series	gray		1825618-3
BPT1532004		black		1825599-3
BPT1532204		red		1825599-1
BPT1532804		gray		1825599-2