



May 2015 Ver.1.1
TDK Corporation

Multilayer Balun

For LTE

HHM Series

1608 TYPE

P/N: **HHM17166A1**

HHM17166A1

SHAPES AND DIMENSIONS

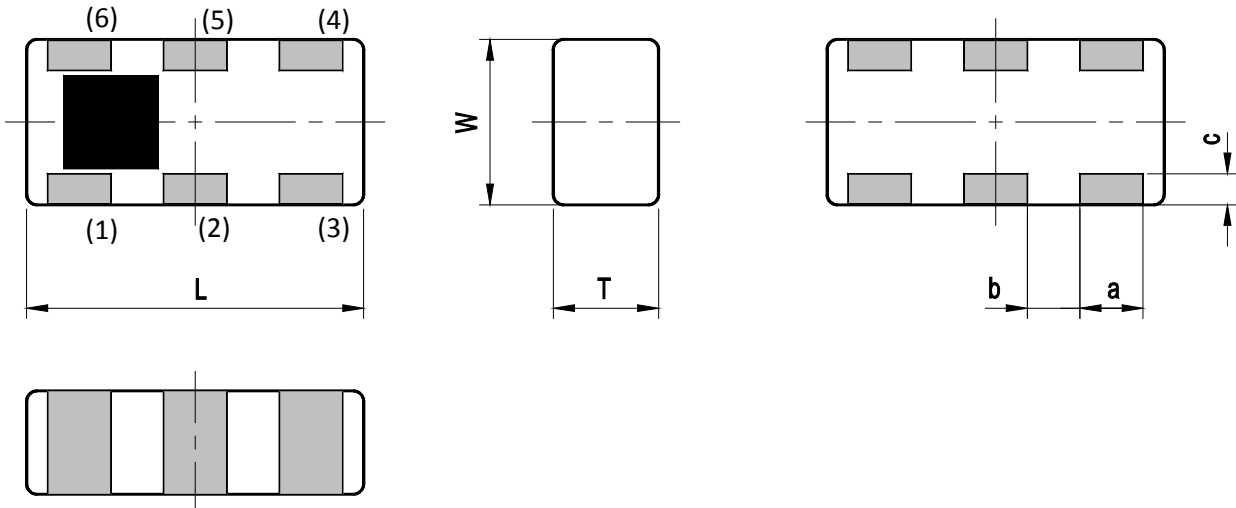

Dimensions (mm)

L	W	T	a	b	c
1.60	0.80	0.60	0.30	0.25	0.15
+/-0.10	+/-0.10	+/-0.10	+/-0.10	+/-0.10	+/-0.10

Terminal functions

(1)	Unbalanced Port
(2)	DC feed + RF GND or GND
(3)	Balanced Port
(4)	Balanced Port
(5)	GND

(6)	N.C.
-----	------

Note:

These samples are marked with trial sample identification.

In mass production, this sample marking will be changed to show in the TDK full specification.

TEMPERATURE RANGE

Operating temperature	Storage temperature
-40 to +85 °C	-40 to +85 °C

HHM17166A1

■ ELECTRICAL CHARACTERISTICS

(Measurement)

Parameter	Frequency (MHz)	TDK Spec		
		Min.	Typ.	Max.
Unbalanced Port Characteristic Impedance		50		
Balanced Port Characteristic Impedance		20.1-j11.4		
Return Loss at Unbalanced Port (dB)	1900 to 2300	8	10.3	-
Phase Balance (deg.)	1900 to 2300	170	178	190
Amplitude Balance (dB)	1900 to 2300	-1.00	0.22	1.00
Insertion Loss (dB)	1900 to 2300	-	1.51	2.20
Power Handling (W)		-		1

Ta = +25+/-5°C

HHM17166A1

FREQUENCY CHARACTERISTICS

HHM17166A1(UNBALANCE 50ohmBALANCE 20.1-j11.4ohm)

Return Loss

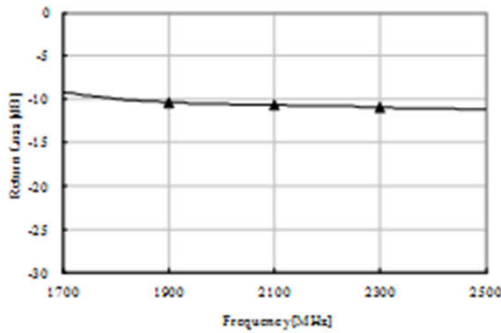

Amplitude Balance

1900.0 MHz
 -10.37 dB
 2100.0 MHz
 -10.69 dB
 2300.0 MHz
 -10.96 dB

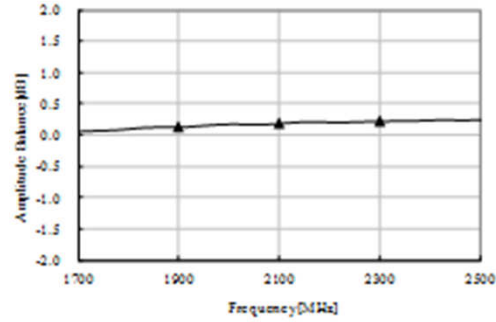

1900.0 MHz
 0.12 dB
 2100.0 MHz
 0.18 dB
 2300.0 MHz
 0.22 dB

Insertion Loss

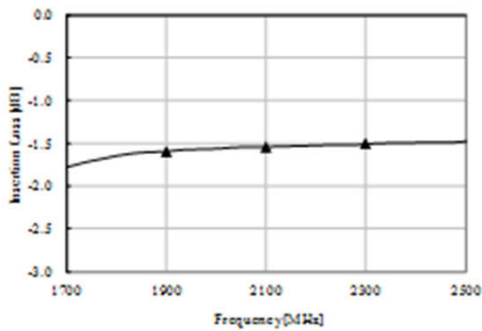

Phase Balance

1900.0 MHz
 -1.60 dB
 2100.0 MHz
 -1.55 dB
 2300.0 MHz
 -1.51 dB

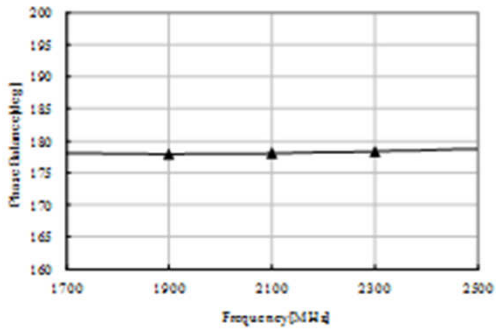

1900.0 MHz
 177.89 deg
 2100.0 MHz
 178.01 deg
 2300.0 MHz
 178.34 deg

HHM17166A1

■ RECOMMENDED LAND PATTERN

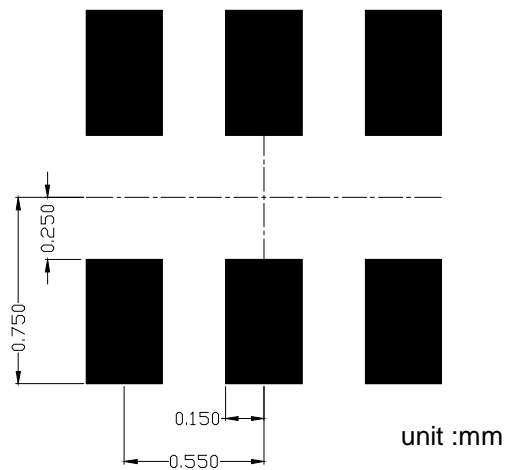

■ ENVIROMENT INFORMATION

RoHS Statement
RoHS Compliance

HHM17166A1

■ RECOMMENDED REFLOW PROFILE

Pb free solder

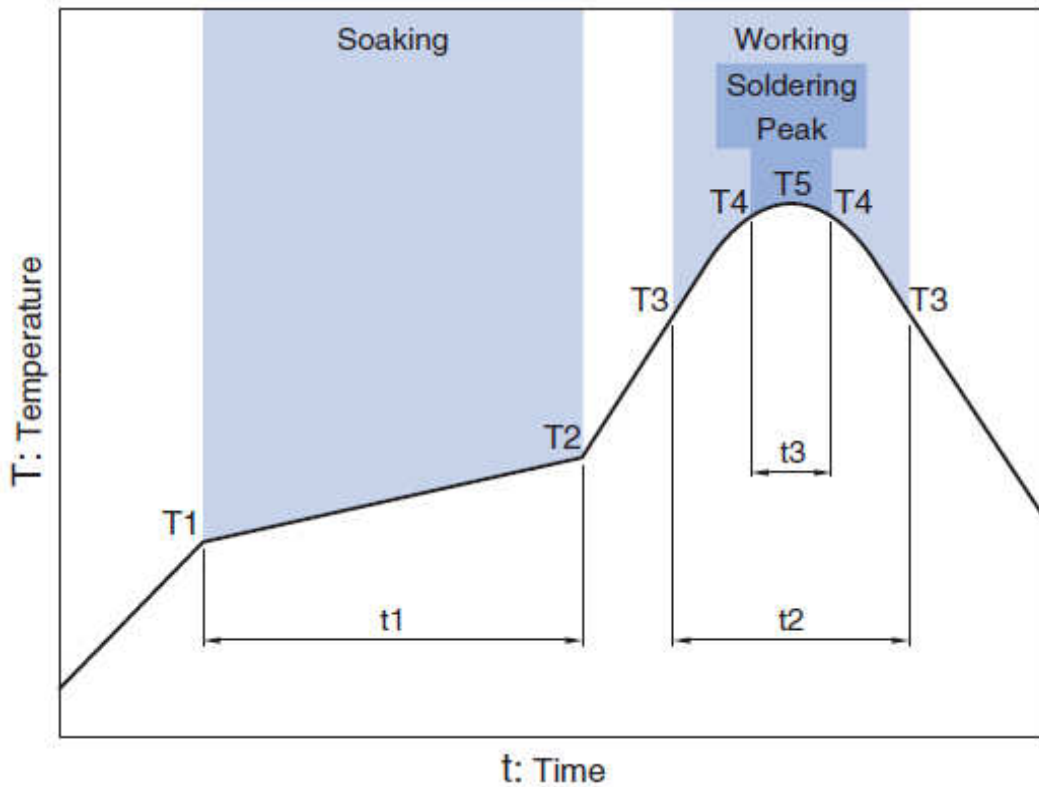

Soaking			Working		Soldering		Peak
Temp.	Temp.	Time	Temp.	Time	Temp.	Time	Temp.
T1	T2	t1	T3	t2	T4	t3	T5
150°C	180°C	60 to 120sec	230°C	more than 30sec	247 to 253°C	within 10sec	260°C Max.

HHM17166A1

PACKAGING STYLE

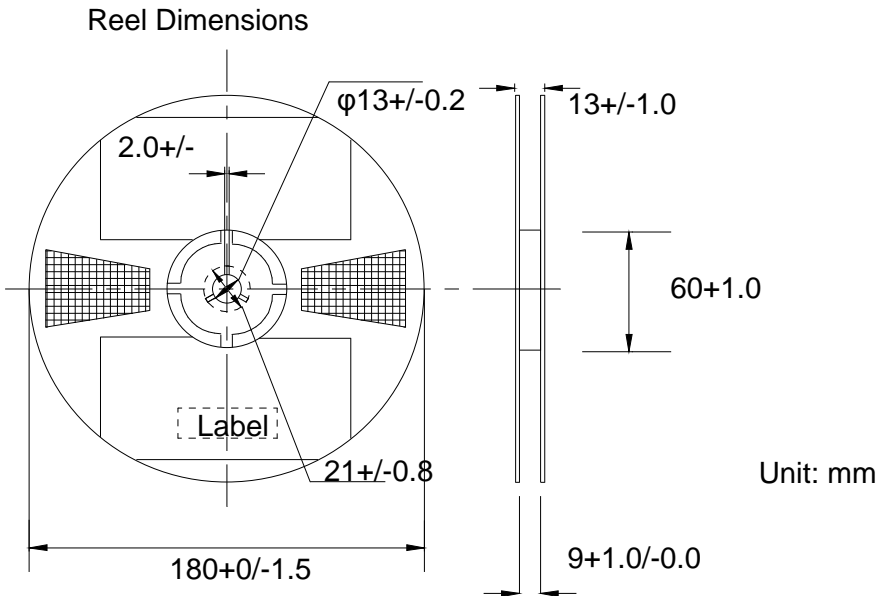

Carrier Tape

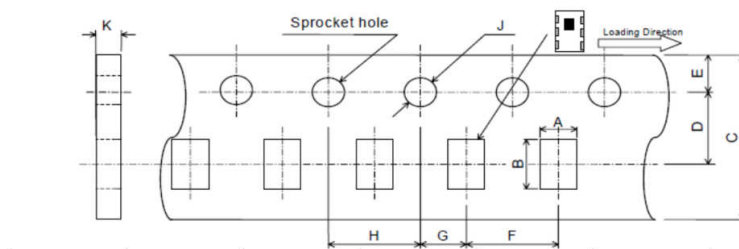

A	B	C	D	E	F
0.97+/-0.05	1.8+/-0.05	8.0+/-0.2	3.5+/-0.05	1.75+/-0.1	4.0±0.1
G	H	J	K		
2.0+/-0.05	4.0+/-0.1	1.5+0.1/-0	0.75+/-0.05		

STANDARD PACKAGE QUANTITY (pieces/reel)
4,000

REMINDERS FOR USING THESE PRODUCTS

Before using these products, be sure to request the delivery specifications.

SAFETY REMINDERS

Please pay sufficient attention to the warnings for safe designing when using these products.

REMINDERS

The products listed on this specification sheet are intended for use in general electronic equipment (AV equipment, telecommunications equipment, home appliances, amusement equipment, computer equipment, personal equipment, office equipment, measurement equipment, industrial robots) under a normal operation and use condition.

The products are not designed or warranted to meet the requirements of the applications listed below, whose performance and/or quality require a more stringent level of safety or reliability, or whose failure, malfunction or trouble could cause serious damage to society, person or property. Please understand that we are not responsible for any damage or liability caused by use of the products in any of the applications below or for any other use exceeding the range or conditions set forth in this specification sheet.

1. Aerospace/Aviation equipment
2. Transportation equipment (cars, electric trains, ships, etc.)
3. Medical equipment
4. Power-generation control equipment
5. Atomic energy-related equipment
6. Seabed equipment
7. Transportation control equipment
8. Public information-processing equipment
9. Military equipment
10. Electric heating apparatus, burning equipment
11. Disaster prevention/crime prevention equipment
12. Safety equipment
13. Other applications that are not considered general-purpose applications

When using this product in general-purpose applications, you are kindly requested to take into consideration securing protection circuit/equipment or providing backup circuits, etc., to ensure higher safety.