

ASMT-UWB1-Nxxxx

OneWhite Surface-Mount PLCC-2 LED Indicator



Description

This family of SMT LEDs is packaged in the industry standard PLCC-2 package. These SMT LEDs have high reliability performance and are designed to work under a wide range of environmental conditions. This high reliability feature makes them ideally suited to be used as interior signs application conditions.

To facilitate easy pick and place assembly, the LEDs are packed in EIA-compliant tape and reel. Every reel will be shipped in single intensity and color bin.

These LEDs are compatible with reflow soldering process.

The wide viewing angle at 120° makes these LEDs ideally suited for panel, push button, office equipment, industrial equipment, and home appliances. The flat top emitting surface makes it easy for these LEDs to mate with light pipes. With the built-in reflector pushing up the intensity of the light output, these LEDs are also suitable to be used as LED pixels in interior electronic signs.

Features

- High reliability package with silicone encapsulation
- Compatible with reflow soldering process
- High optical efficiency with 100 lm/W
- Available in 8-mm carrier tape with reel diameter 180 mm
- JEDEC MSL 3 product
- ESD threshold of 1000V (HBM model) per JEDEC

Applications

- Non-automotive use
- General signage backlighting
- Amusement machine backlighting
- Industrial lighting
- Light strips

CAUTION! LEDs are ESD sensitive. Please observe appropriate precautions during handling and processing.

Package Drawing



NOTE:

1. All dimensions in millimeters.
2. Terminal finish = Ag plating.

Device Selection Guide

| Color | Part Number | CCT (K) | Luminous Intensity (mcd) ^{a, b} | | | Test Current (mA) | Chip |
|-------|-----------------|-------------|--|------|------|-------------------|-------|
| | | | Min. | Typ. | Max. | | |
| White | ASMT-UWB1-NX302 | 4500 ~ 8000 | 1800 | 2300 | 3550 | 20 | InGaN |
| White | ASMT-UWB1-NX312 | 2700 ~ 4000 | 1800 | 2300 | 3550 | 20 | InGaN |
| White | ASMT-UWB1-NX3A2 | 8000 | 1800 | 2300 | 3550 | 20 | InGaN |
| White | ASMT-UWB1-NX3B2 | 6500 | 1800 | 2300 | 3550 | 20 | InGaN |
| White | ASMT-UWB1-NX3C2 | 5700 | 1800 | 2300 | 3550 | 20 | InGaN |
| White | ASMT-UWB1-NX3D2 | 5000 | 1800 | 2300 | 3550 | 20 | InGaN |
| White | ASMT-UWB1-NX3E2 | 4500 | 1800 | 2300 | 3550 | 20 | InGaN |
| White | ASMT-UWB1-NX3F2 | 4000 | 1800 | 2300 | 3550 | 20 | InGaN |
| White | ASMT-UWB1-NX3G2 | 3500 | 1800 | 2300 | 3550 | 20 | InGaN |
| White | ASMT-UWB1-NX3H2 | 3000 | 1800 | 2300 | 3550 | 20 | InGaN |
| White | ASMT-UWB1-NX3J2 | 2700 | 1800 | 2300 | 3550 | 20 | InGaN |
| White | ASMT-UWB1-NX7B2 | 6500 | 2240 | - | 4500 | 20 | InGaN |
| White | ASMT-UWB1-NX7D2 | 5000 | 2240 | - | 4500 | 20 | InGaN |
| White | ASMT-UWB1-NX7C2 | 5700 | 2240 | - | 4500 | 20 | InGaN |

a. The luminous intensity is measured at the mechanical axis of the lamp package. The actual peak of the spatial radiation pattern may not be aligned with this axis.

b. Tolerance $\pm 12\%$

Part Numbering System



Absolute Maximum Ratings (T_A = 25°C)

| Parameters | Rating |
|-----------------------------------|-----------------|
| DC Forward Current ^a | 30 mA |
| Peak Forward Current ^b | 100 mA |
| Power Dissipation | 108 mW |
| Junction Temperature | 110°C |
| Operating Temperature | -40°C to +100°C |
| Storage Temperature | -40°C to +100°C |

a. Derate linearly as shown in derating curve.

b. Duty factor = 10%, frequency = 1 kHz.

Optical Characteristics (T_A = 25°C)

| Color | Part Number | Dice Technology | Typ. Chromaticity Coordinates ^a | | Viewing Angle 2θ _{1/2} ^b (Degrees) | Luminous Efficiency η _e (lm/W) | Total Flux / Luminous Intensity θ _V (lm) / I _V (cd) | CRI |
|-------|-------------|-----------------|--|------|---|--|---|------|
| | | | x | y | Typ. | Typ. | Typ. | Min. |
| White | ASMT-UWB1 | InGaN | 0.33 | 0.34 | 120 | 100 | 2.8 | 70 |

a. The chromaticity coordinates are derived from the CIE 1931 Chromaticity diagram and represents the perceived color of the device.

b. θ_{1/2} is the off-axis angle where the luminous intensity is 1/2 the peak intensity.

Electrical Characteristics (T_A = 25°C)

| Color | Part Number | Forward Voltage V _F (Volts) @ I _F = 20 mA | | Reverse Voltage V _R ^a @ 10 μA | Thermal Resistance R _{θJ-P} (°C/W) |
|-------|-------------|--|------|--|--|
| | | Min. | Max. | Min. | |
| White | ASMT-UWB1 | 2.4 | 3.2 | 5 | 150 |

a. Reverse Voltage indicates product final test condition. Long-term reverse bias is not recommended.

Figure 1: Forward Current vs. Forward Voltage

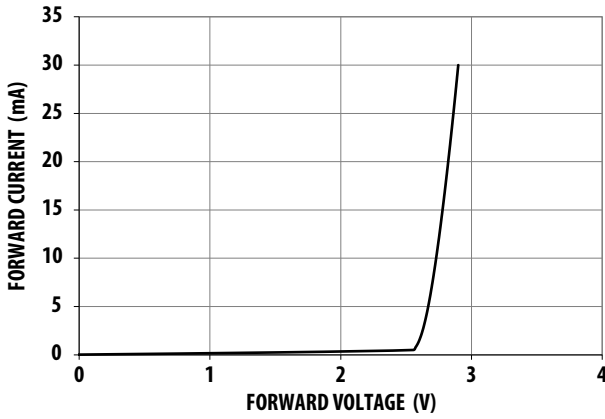

Figure 2: Relative Intensity vs. Forward Current

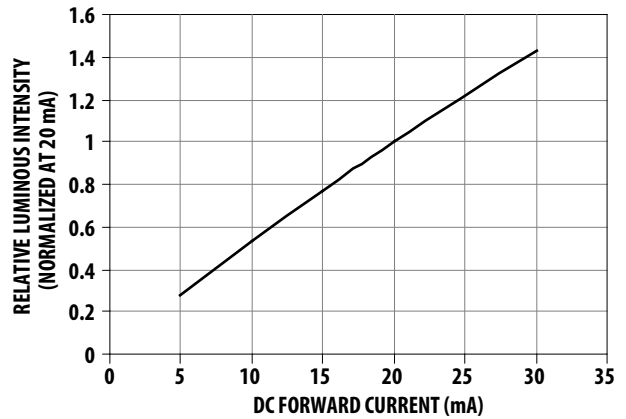

Figure 3: Chromaticity Shift vs. Current

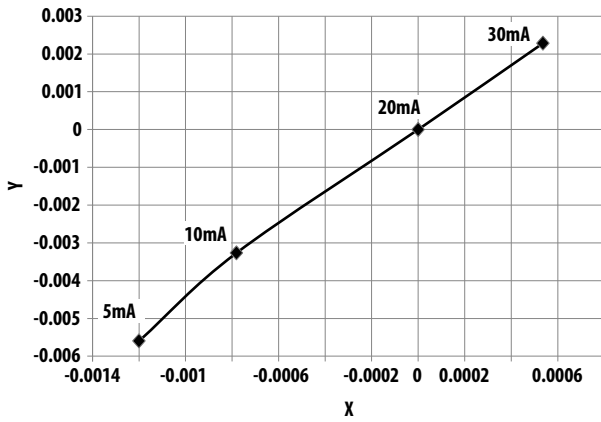

Figure 4: Radiation Pattern

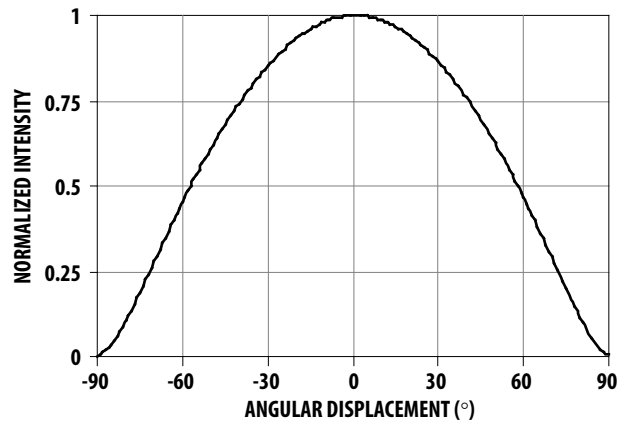

Figure 5: Maximum Forward Current vs. Ambient Temperature. Derated based on T_{jmax} 110°C, R_{thja} 600°C/W

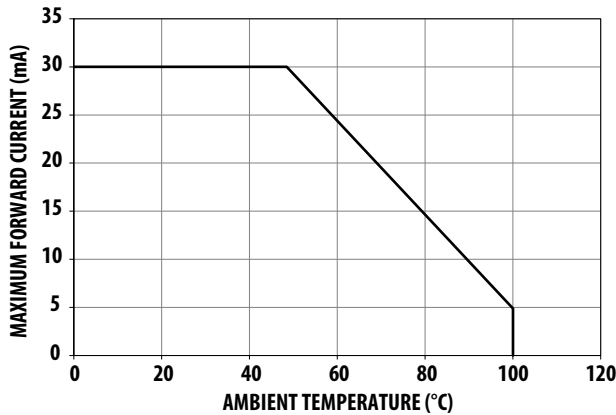

Figure 6: Recommended Pb-Free Reflow Soldering Profile

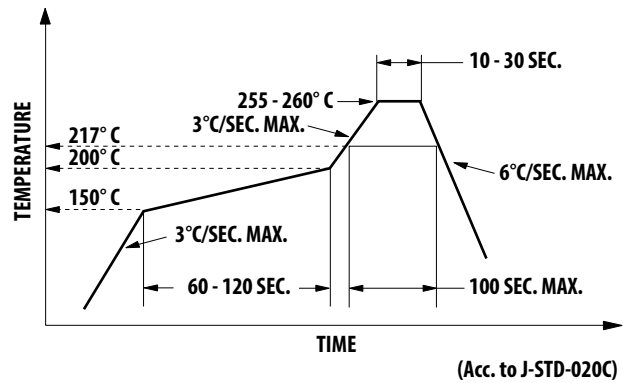

Figure 7: Recommended Soldering Pad Pattern



Figure 8: Tape Leader and Trailer Dimensions



Figure 9: Tape Dimensions (Unit: mm)

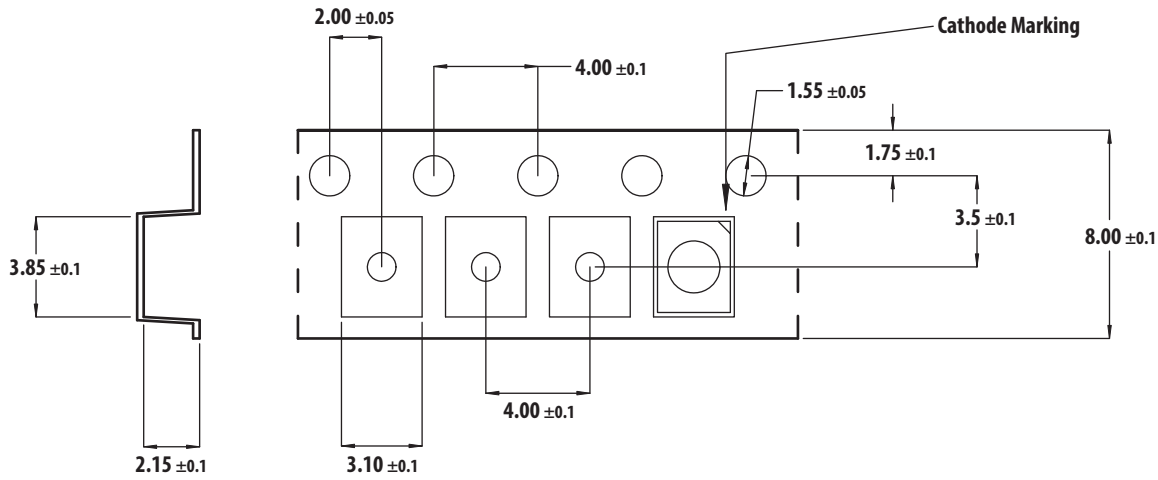

Figure 10: Reel Dimensions (Unit: mm)



Figure 11: Reel Orientation



Intensity Bin Select (X₂ X₃)

Individual reel will contain parts from one half bin only.

| X ₂ | Min IV Bin |
|----------------|------------|
| | |

| X ₃ | |
|----------------|-------------------------------|
| 0 | Full Distribution |
| 3 | 3 half bins starting from x21 |
| 4 | 4 half bins starting from x21 |
| 5 | 5 half bins starting from x21 |
| 7 | 3 half bins starting from x22 |
| 8 | 4 half bins starting from x22 |
| 9 | 5 half bins starting from x22 |

Intensity Bin Limits

| Bin ID | Min. (mcd) | Max. (mcd) |
|--------|------------|------------|
| X1 | 1800 | 2240 |
| X2 | 2240 | 2850 |
| Y1 | 2850 | 3550 |
| Y2 | 3550 | 4500 |
| Z1 | 4500 | 5600 |
| Z2 | 5600 | 7150 |
| AA | 2000 | 2500 |

Tolerance of each bin limit = ±12%

Color Bin Selection (X₄)

Individual reel will contain parts from one full bin only.

| X ₄ | |
|----------------|--|
| Bin | Color Bin ID |
| A | 1A, 1B, 1C, 1D |
| B | 2A, 2B, 2C, 2D |
| C | 3A, 3B, 3C, 3D |
| D | 4A, 4B, 4C, 4D |
| E | 5A, 5B, 5C, 5D |
| F | 6A, 6B, 6C, 6D |
| G | 7A, 7B, 7C, 7D |
| H | 8A, 8B, 8C, 8D |
| J | 9A, 9B, 9C, 9D |
| K | 1A, 1B, 1C, 1D, 2A, 2B, 2C, 2D, |
| L | 2A, 2B, 2C, 2D, 3A, 3B, 3C, 3D |
| M | 3A, 3B, 3C, 3D, 4A, 4B, 4C, 4D |
| N | 4A, 4B, 4C, 4D, 5A, 5B, 5C, 5D |
| Q | 6A, 6B, 6C, 6D, 7A, 7B, 7C, 7D |
| R | 7A, 7B, 7C, 7D, 8A, 8B, 8C, 8D |
| S | 8A, 8B, 8C, 8D, 9A, 9B, 9C, 9D |
| 0 | 1A, 1B, 1C, 1D, 2A, 2B, 2C, 2D, 3A, 3B, 3C, 3D, 4A, 4B, 4C, 4D, 5A, 5B, 5C, 5D |
| 1 | 6A, 6B, 6C, 6D, 7A, 7B, 7C, 7D, 8A, 8B, 8C, 8D, 9A, 9B, 9C, 9D |

Color Bin ID Limits

| Color Bin ID | Chromaticity Coordinates Limits | | | | |
|--------------|---------------------------------|--------|--------|--------|--------|
| | | | | | |
| 1A | x | 0.2950 | 0.2920 | 0.2984 | 0.3009 |
| | y | 0.2970 | 0.3060 | 0.3133 | 0.3042 |
| 1B | x | 0.2920 | 0.2895 | 0.2962 | 0.2984 |
| | y | 0.3060 | 0.3135 | 0.3220 | 0.3133 |
| 1C | x | 0.2984 | 0.2962 | 0.3028 | 0.3048 |
| | y | 0.3133 | 0.3220 | 0.3304 | 0.3207 |
| 1D | x | 0.2984 | 0.3048 | 0.3068 | 0.3009 |
| | y | 0.3133 | 0.3207 | 0.3113 | 0.3042 |
| 2A | x | 0.3048 | 0.3130 | 0.3144 | 0.3068 |
| | y | 0.3207 | 0.3290 | 0.3186 | 0.3113 |
| 2B | x | 0.3028 | 0.3115 | 0.3130 | 0.3048 |
| | y | 0.3304 | 0.3391 | 0.3290 | 0.3207 |
| 2C | x | 0.3115 | 0.3205 | 0.3213 | 0.3130 |
| | y | 0.3391 | 0.3481 | 0.3373 | 0.3290 |
| 2D | x | 0.3130 | 0.3213 | 0.3221 | 0.3144 |
| | y | 0.3290 | 0.3373 | 0.3261 | 0.3186 |
| 3A | x | 0.3215 | 0.3290 | 0.3290 | 0.3222 |
| | y | 0.3350 | 0.3417 | 0.3300 | 0.3243 |
| 3B | x | 0.3207 | 0.3290 | 0.3290 | 0.3215 |
| | y | 0.3462 | 0.3538 | 0.3417 | 0.3350 |
| 3C | x | 0.3290 | 0.3376 | 0.3371 | 0.3290 |
| | y | 0.3538 | 0.3616 | 0.3490 | 0.3417 |
| 3D | x | 0.3290 | 0.3371 | 0.3366 | 0.3290 |
| | y | 0.3417 | 0.3490 | 0.3369 | 0.3300 |
| 4A | x | 0.3371 | 0.3451 | 0.3440 | 0.3366 |
| | y | 0.3490 | 0.3554 | 0.3427 | 0.3369 |
| 4B | x | 0.3376 | 0.3463 | 0.3451 | 0.3371 |
| | y | 0.3616 | 0.3687 | 0.3554 | 0.3490 |
| 4C | x | 0.3463 | 0.3551 | 0.3533 | 0.3451 |
| | y | 0.3687 | 0.3760 | 0.3620 | 0.3554 |
| 4D | x | 0.3451 | 0.3533 | 0.3515 | 0.3440 |
| | y | 0.3554 | 0.3620 | 0.3487 | 0.3427 |
| 5A | x | 0.3530 | 0.3615 | 0.3590 | 0.3512 |
| | y | 0.3597 | 0.3659 | 0.3521 | 0.3465 |
| 5B | x | 0.3548 | 0.3641 | 0.3615 | 0.3530 |
| | y | 0.3736 | 0.3804 | 0.3659 | 0.3597 |
| 5C | x | 0.3641 | 0.3736 | 0.3702 | 0.3615 |
| | y | 0.3804 | 0.3874 | 0.3722 | 0.3659 |
| 5D | x | 0.3615 | 0.3702 | 0.3670 | 0.3590 |
| | y | 0.3659 | 0.3722 | 0.3578 | 0.3521 |
| 6A | x | 0.3670 | 0.3702 | 0.3825 | 0.3783 |
| | y | 0.3578 | 0.3722 | 0.3798 | 0.3646 |

| Color Bin ID | Chromaticity Coordinates Limits | | | | |
|--------------|---------------------------------|--------|--------|--------|--------|
| | | | | | |
| 6B | x | 0.3702 | 0.3736 | 0.3869 | 0.3825 |
| | y | 0.3722 | 0.3874 | 0.3958 | 0.3798 |
| 6C | x | 0.3825 | 0.3869 | 0.4006 | 0.3950 |
| | y | 0.3798 | 0.3958 | 0.4044 | 0.3875 |
| 6D | x | 0.3783 | 0.3825 | 0.3950 | 0.3898 |
| | y | 0.3646 | 0.3798 | 0.3875 | 0.3716 |
| 7A | x | 0.3889 | 0.3941 | 0.4080 | 0.4017 |
| | y | 0.3690 | 0.3848 | 0.3916 | 0.3751 |
| 7B | x | 0.3941 | 0.3996 | 0.4146 | 0.4080 |
| | y | 0.3848 | 0.4015 | 0.4089 | 0.3916 |
| 7C | x | 0.4080 | 0.4146 | 0.4299 | 0.4221 |
| | y | 0.3916 | 0.4089 | 0.4165 | 0.3984 |
| 7D | x | 0.4017 | 0.4080 | 0.4221 | 0.4147 |
| | y | 0.3751 | 0.3916 | 0.3984 | 0.3814 |
| 8A | x | 0.4147 | 0.4221 | 0.4342 | 0.4259 |
| | y | 0.3814 | 0.3984 | 0.4028 | 0.3853 |
| 8B | x | 0.4221 | 0.4299 | 0.4430 | 0.4342 |
| | y | 0.3984 | 0.4165 | 0.4212 | 0.4028 |
| 8C | x | 0.4342 | 0.4430 | 0.4562 | 0.4465 |
| | y | 0.4028 | 0.4212 | 0.4260 | 0.4071 |
| 8D | x | 0.4259 | 0.4342 | 0.4465 | 0.4373 |
| | y | 0.3853 | 0.4028 | 0.4071 | 0.3893 |
| 9A | x | 0.4373 | 0.4465 | 0.4582 | 0.4483 |
| | y | 0.3893 | 0.4071 | 0.4099 | 0.3919 |
| 9B | x | 0.4465 | 0.4562 | 0.4687 | 0.4582 |
| | y | 0.4071 | 0.4260 | 0.4289 | 0.4099 |
| 9C | x | 0.4582 | 0.4687 | 0.4813 | 0.4700 |
| | y | 0.4099 | 0.4289 | 0.4319 | 0.4126 |
| 9D | x | 0.4483 | 0.4582 | 0.4700 | 0.4593 |
| | y | 0.3919 | 0.4099 | 0.4126 | 0.3944 |

Tolerance of each bin limit = ± 0.01

Figure 12: Color Bins



Packaging Option (X₅)

| Option | Test Current | Package Type | Reel Size |
|--------|--------------|--------------|-----------|
| 2 | 20 mA | Top Mount | 7 Inch |

Forward Voltage Bin

| Bin ID | Min. | Max |
|--------|------|-----|
| F03 | 2.4 | 2.6 |
| F04 | 2.6 | 2.8 |
| F05 | 2.8 | 3.0 |
| F06 | 3.0 | 3.2 |

Tolerance of each bin limit = ±0.1V.

Precautionary Notes

Handling Precautions

The encapsulation material of the LED is made of silicone for better product reliability. Compared to epoxy encapsulant that is hard and brittle, silicone is softer and flexible. Observe special handling precautions during assembly of silicone encapsulated LED products. Failure to comply might lead to damage and premature failure of the LED. Refer to Application Note AN5288, *Silicone Encapsulation for LED: Advantages and Handling Precautions*, for more information.

- Do not poke sharp objects into the silicone encapsulant. Sharp objects, such as tweezers or syringes, might apply excessive force or even pierce through the silicone and induce failures to the LED die or wire bond.
- Do not touch the silicone encapsulant. Uncontrolled force acting on the silicone encapsulant might result in excessive stress on the wire bond. Hold the LED only by the body.
- Do not stack assembled PCBs together. Use an appropriate rack to hold the PCBs.
- The surface of the silicone material attracts dust and dirt easier than epoxy due to its surface tackiness. To remove foreign particles on the surface of silicone, use a cotton bud with isopropyl alcohol (IPA). During cleaning, rub the surface gently without putting much pressure on the silicone. Ultrasonic cleaning is not recommended.
- For automated pick and place, Broadcom has tested the following nozzle size to work well with this LED. However, due to the possibility of variations in other parameters, such as pick and place, machine maker/model and other settings of the machine, verify that the selected nozzle will not cause damage to the LED.



Handling Moisture-Sensitive Devices

This product has a Moisture Sensitive Level 3 rating per JEDEC J-STD-020. Refer to Broadcom Application Note AN5305, *Handling of Moisture Sensitive Surface Mount Devices*, for additional details and a review of proper handling procedures.

- **Before use**
 - An unopened moisture barrier bag (MBB) can be stored at $< 40^{\circ}\text{C}/90\% \text{ RH}$ for 12 months. If the actual shelf life has exceeded 12 months and the humidity indicator card (HIC) indicates that baking is not required, it is safe to reflow the LEDs per the original MSL rating.
 - Do not open the MBB prior to assembly (for example, for IQC).
- **Control after opening the MBB:**
 - Read the HIC immediately upon opening the MBB.
 - Keep the LEDs at $< 30^{\circ}\text{C} / 60\% \text{ RH}$ at all times and all high temperature-related processes, including soldering, curing, or rework, must be completed within 168 hours.
- **Control for unfinished reel:**

Store unused LEDs in a sealed MBB with desiccant or desiccator at $< 5\% \text{ RH}$.
- **Control of assembled boards:**

If the PCB soldered with the LEDs is to be subjected to other high-temperature processes, store the PCB in a sealed MBB with desiccant or desiccator at $< 5\% \text{ RH}$ to ensure that all LEDs have not exceeded their floor life of 168 hours.
- **Baking is required if the following conditions exist:**
 - The HIC indicator is not BROWN at 10% and is AZURE at 5%.
 - The LEDs are exposed to condition of $> 30^{\circ}\text{C} / 60\% \text{ RH}$ at any time.
 - The LED floor life exceeded 168 hours.

The recommended baking condition is: $60^{\circ}\text{C} \pm 5^{\circ}\text{C}$ for 20 hours.

Baking should only be done once.
- **Storage:**

The soldering terminals of these Broadcom LEDs are silver plated. If the LEDs are exposed in an ambient environment for too long, the silver plating might be oxidized, thus affecting its solderability performance. As such, keep unused LEDs in a sealed MBB with desiccant or in desiccator at $< 5\% \text{ RH}$.

Application Precautions

- The drive current of the LED must not exceed the maximum allowable limit across temperature as stated in the data sheet. Constant current driving is recommended to ensure consistent performance.
- LEDs exhibit slightly different characteristics at different drive currents that might result in larger variations in their performance (that is, intensity, wavelength, and forward voltage). Set the application current as close as possible to the test current to minimize these variations.
- The LED is not intended for reverse bias. Use other appropriate components for such purposes. When driving the LED in matrix form, ensure that the reverse bias voltage does not exceed the allowable limit of the LED.
- Do not use the LED in the vicinity of material with sulfur content, in environments of high gaseous sulfur compounds and corrosive elements. Examples of materials that may contain sulfur are rubber gaskets, RTV (room temperature vulcanizing) silicone rubber, rubber gloves, and so on. Prolonged exposure to such environments may affect the optical characteristics and product life.
- Avoid rapid change in ambient temperature, especially in high-humidity environments, because this will cause condensation on the LED.
- Although the LED is rated as IPx6 according to IEC60529: Degree of protection provided by enclosure, the test condition may not represent actual exposure during application. If the LED is intended to be used in outdoor or harsh environments, the LED must be protected against damages caused by rain water, dust, oil, corrosive gases, external mechanical stress, and so on.

Thermal Management

Optical, electrical, and reliability characteristics of LED are affected by temperature. The junction temperature (T_J) of the LED must be kept below allowable limit at all times. T_J can be calculated as follows:

$$T_J = T_A + R_{\theta J-A} \times I_F \times V_{Fmax}$$

where;

T_A = ambient temperature ($^{\circ}\text{C}$)

$R_{\theta J-A}$ = thermal resistance from LED junction to ambient ($^{\circ}\text{C}/\text{W}$)

I_F = forward current (A)

V_{Fmax} = maximum forward voltage (V)

The complication of using this formula lies in T_A and $R_{\theta J-A}$. Actual T_A is sometimes subjective and hard to determine. $R_{\theta J-A}$ varies from system to system depending on design and is usually not known.

Another way of calculating T_J is by using solder point temperature T_S as follows:

$$T_J = T_S + R_{\theta J-S} \times I_F \times V_{Fmax}$$

where;

T_S = LED solder point temperature as shown in the following figure ($^{\circ}\text{C}$)

$R_{\theta J-S}$ = Thermal resistance from junction to solder point ($^{\circ}\text{C}/\text{W}$)

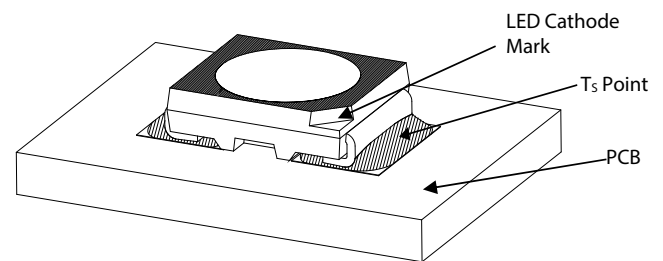

T_S can be measured easily by mounting a thermocouple on the soldering joint as shown in the preceding figure, while $R_{\theta J-S}$ is provided in the data sheet. Verify the T_S of the LED in the final product to ensure that the LEDs are operated within all maximum ratings stated in the data sheet.

Eye Safety Precautions

LEDs may pose optical hazards when in operation. Do not look directly at operating LEDs because it may be harmful to the eyes. For safety reasons, use appropriate shielding or personal protective equipment.

Disclaimer

Broadcom's products are not specifically designed, manufactured, or authorized for sale as parts, components, or assemblies for the planning, construction, maintenance, or direct operation of a nuclear facility or for use in medical devices or applications. Customers are solely responsible, and waive all rights to make claims against Broadcom or its suppliers, for all loss, damage, expense, or liability in connection with such use.

Broadcom, the pulse logo, Connecting everything, Avago Technologies, Avago, and the A logo are among the trademarks of Broadcom and/or its affiliates in the United States, certain other countries, and/or the EU.

Copyright © 2015–2018 Broadcom. All Rights Reserved.

The term "Broadcom" refers to Broadcom Limited and/or its subsidiaries. For more information, please visit www.broadcom.com.

Broadcom reserves the right to make changes without further notice to any products or data herein to improve reliability, function, or design. Information furnished by Broadcom is believed to be accurate and reliable. However, Broadcom does not assume any liability arising out of the application or use of this information, nor the application or use of any product or circuit described herein, neither does it convey any license under its patent rights nor the rights of others.

