

Part Number	Description
LPBD100	.25A, 100Vdc dual solid-state relay

**MECHANICAL SPECIFICATION**

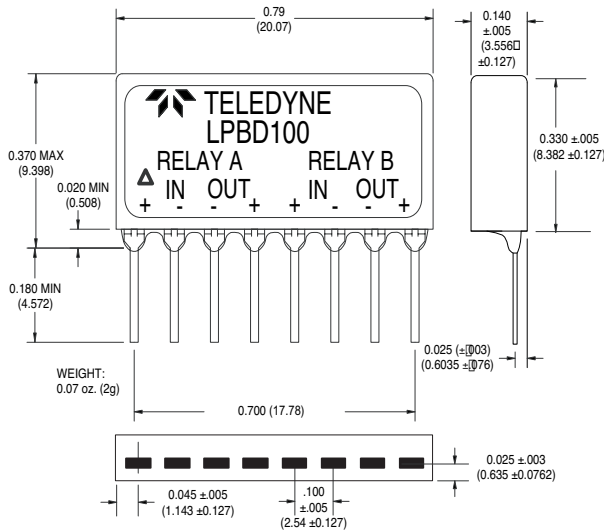
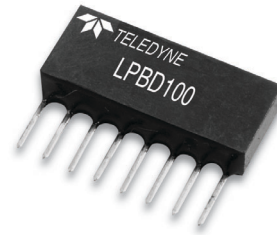

Figure 1 – LPBD100 relay; dimensions in inches (mm)



**FEATURES/BENEFITS**

- Compact SIP plastic package
- Dual output: two relays in one package
- Normally closed output
- Low voltage drop

**DESCRIPTION**

The LPBD100 is a dual-output 100Vdc plastic relay. The relay output-switch contacts are normally closed and will conduct the load current until a voltage is applied to the relay input. With 4 volts or more at the relay input, the output-switch contacts open and the relay no longer conducts. The LPBD100 assembly contains two independent relays, completely isolated from each other, in a single in-line package (SIP). The relays provide optical isolation between input and output terminals. Each relay output circuit uses a pair of depletion-mode MOSFETs for reliable operation.

**INPUT (CONTROL) SPECIFICATIONS**

	Min	Max	Units
Control Voltage Range (See Note 1)	4.0	7.0	Vdc
Input Current @ 5 Vdc (See Figure 2)		12	mAdc
Must Turn-On Voltage		0.8	Vdc
Must Turn-Off Voltage	4.0		Vdc
Must Turn-On Current		50	µAdc
Reverse Voltage	7		Vdc

**APPLICATIONS**

- Interface applications
- Aircraft flight control systems
- A.T.E
- 28Vdc aircraft instrumentation systems

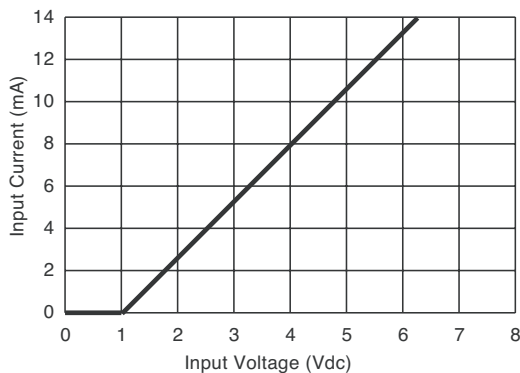

**INPUT CURRENT VS. VOLTAGE**

Figure 2

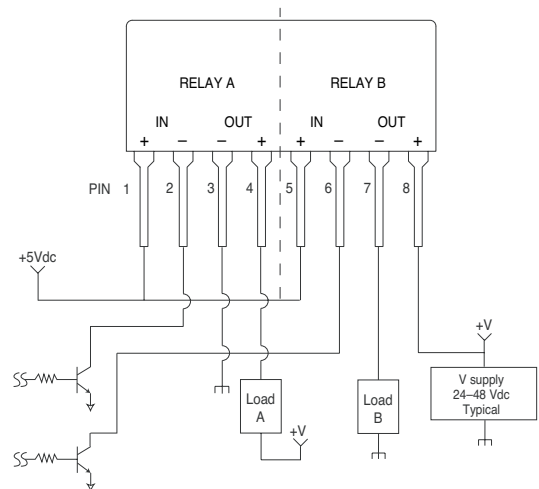

**TYPICAL WIRING DIAGRAM**

Figure 3

**OUTPUT (LOAD) SPECIFICATION**

	Min	Max	Units
Load Voltage Rating		100	Vdc
Load Current Range (See Figure 5)	0.25		Adc
Transient Blocking Voltage		200	Vdc
Output Capacitance@ 25Vdc		120	pF
On-State Voltage Drop (See Figure 4)	1.25		Vdc
On Resistance		5.0	Ohm
Off-State Leakage Current (100 Vdc)		10	μAdc
Turn-On Time		0.5	ms
Turn-Off Time		2.5	ms

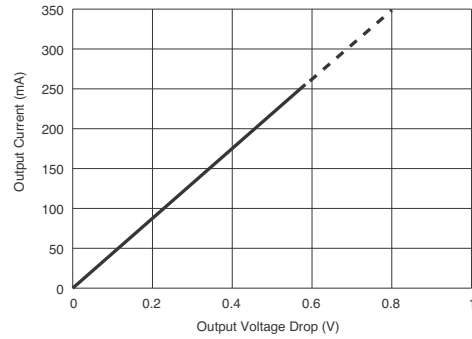

**OUTPUT CURRENT VS. VOLTAGE DROP**

Figure 4

**ENVIRONMENTAL SPECIFICATION**

	Min	Max	Units
Operating Temperature	-40	+85	°C
Storage Temperature	-55	+100	°C
Junction Temperature		125	°C
Thermal Resistance (Junction to Ambient) each relay		120	°C/W
Shock		1500	g
Vibration		100	g
Dielectric Strength	500		Vac
Insulation Resistance (@500 Vdc)	10 <sup>9</sup>		Ohm
Input to Output Capacitance		5	pF
Resistance to			
Soldering Heat	MIL STD 202, method 210		
Solderability	MIL STD 202, method 208		
Thermal Shock	MIL STD 202, method 107		
Altitude	55,000		ft
HAST	JDEC Test Method A110 130°C 85% RH, no power applied, 50 hours		

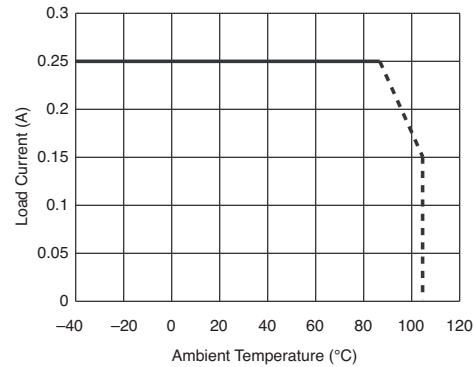

**LOAD CURRENT VS. AMBIENT TEMPERATURE**

Figure 5

**NOTES:**

- For input voltages greater than 7 volts, use an external resistor in series with the relay input.  $R_{ext.} = (V_{in} - 7 \text{ Vdc}) / 0.012 \text{ Amps}$
- Unless otherwise specified: conformance testing is at room temperature; the input voltage is 5Vdc or zero volts as required; the output load is 48Vdc, 0.25 amp.
- Relay input voltage transitions should be less than 1.0 millisecond.
- Maximum load current ratings are with the relay in free air and soldered to a printed circuit board.
- Timing is measured from the input voltage transition to the 10% or 90% point on the output voltage off-to-on or on-to-off transition. Rise and fall times are from the 10% to 90% points on the output voltage transition.

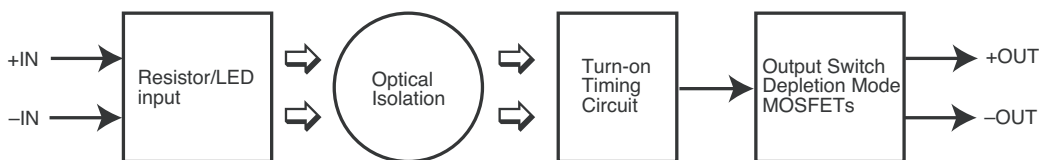

**FUNCTIONAL BLOCK DIAGRAM**

Figure 6