

Spezifikation für Freigabe / specification for release

Kunde / customer :
 Artikelnummer / part number : **S14100036**
 Bezeichnung : **SPEICHERDROSSEL WE-LCB**
 description : **TOROIDAL LINE CHOKE WE-LCB**



DATUM / DATE : 2015-07-23

A Mechanische Abmessungen / dimensions:

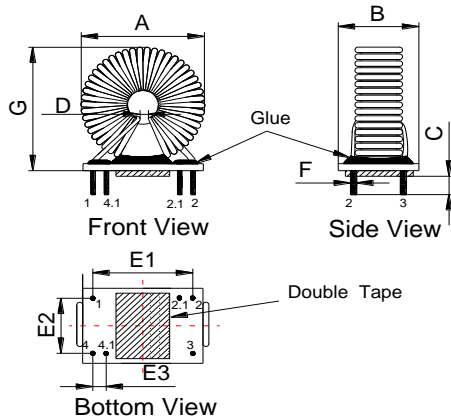

A	36,0 max.	mm
B	23,0 max.	mm
C	4,5 ± 0,5	mm
D	2,0 min.	mm
E1	30,48 ref.	mm
E2	15,24 ref.	mm
E3	5,08 ref.	mm
F	1,8 ref.	mm
G	35,0 max.	mm

B Elektrische Eigenschaften / electrical properties:

Eigenschaften / properties	Testbedingungen / test conditions		Wert / value	Einheit / unit	tol.
Leerlauf-Induktivität / inductance	100 KHz / 0,1V	L_0	56,0	μH	$\pm 20\%$
DC-Widerstand / DC-resistance	@ 20°C	R_{DC}	0,0085	Ω	max.
Nennstrom / rated current	$\Delta T = 40 \text{ K}$	I_{DC}	17,00	A	max.

C Lötpad / soldering spec.:

D Prüfgeräte / test equipment:

Wayne Kerr 3260B für/for L_0
GMC Metrahit 271 Milliohmmeter für/for R_{DC}
Dostmann T900 Thermometer für/for I_{DC}

E Testbedingungen / test conditions:

Luftfeuchtigkeit / humidity: 33%
 Umgebungstemperatur / temperature: +20°C

F Werkstoffe & Zulassungen / material & approvals:

Basismaterial / base material: Eisenpulver / Iron powder
 Draht / wire: Class F

G Eigenschaften / general specifications:

Betriebstemp. / operating temperature: -40°C - + 125°C
 Umgebungstemp. / ambient temperature: -40°C - + 85°C
 It is recommended that the temperature of the part does not exceed 125°C under worst case operating conditions.

Freigabe erteilt / general release:	Kunde / customer		
Datum / date	Unterschrift / signature		
	Würth Elektronik	HasA	Version 3 15-07-23
		HasA	Version 2 15-03-05
		HasA	Version 1 14-04-15
Geprüft / checked	Kontrolliert / approved	Name	Änderung / modification Datum / date

Würth Elektronik eiSos GmbH & Co.KG

D-74638 Waldenbug · Max-Eyth-Strasse 1 - 3 · Germany · Telefon (+49) (0) 7942 - 945 - 0 · Telefax (+49) (0) 7942 - 945 - 400
<http://www.we-online.com>

Spezifikation für Freigabe / specification for release

Kunde / customer :
 Artikelnummer / part number : **S14100036**

Bezeichnung : **SPEICHERDROSSEL WE-LCB**
 description : **TOROIDAL LINE CHOKE WE-LCB**



WÜRTH ELEKTRONIK

DATUM / DATE : 2015-07-23

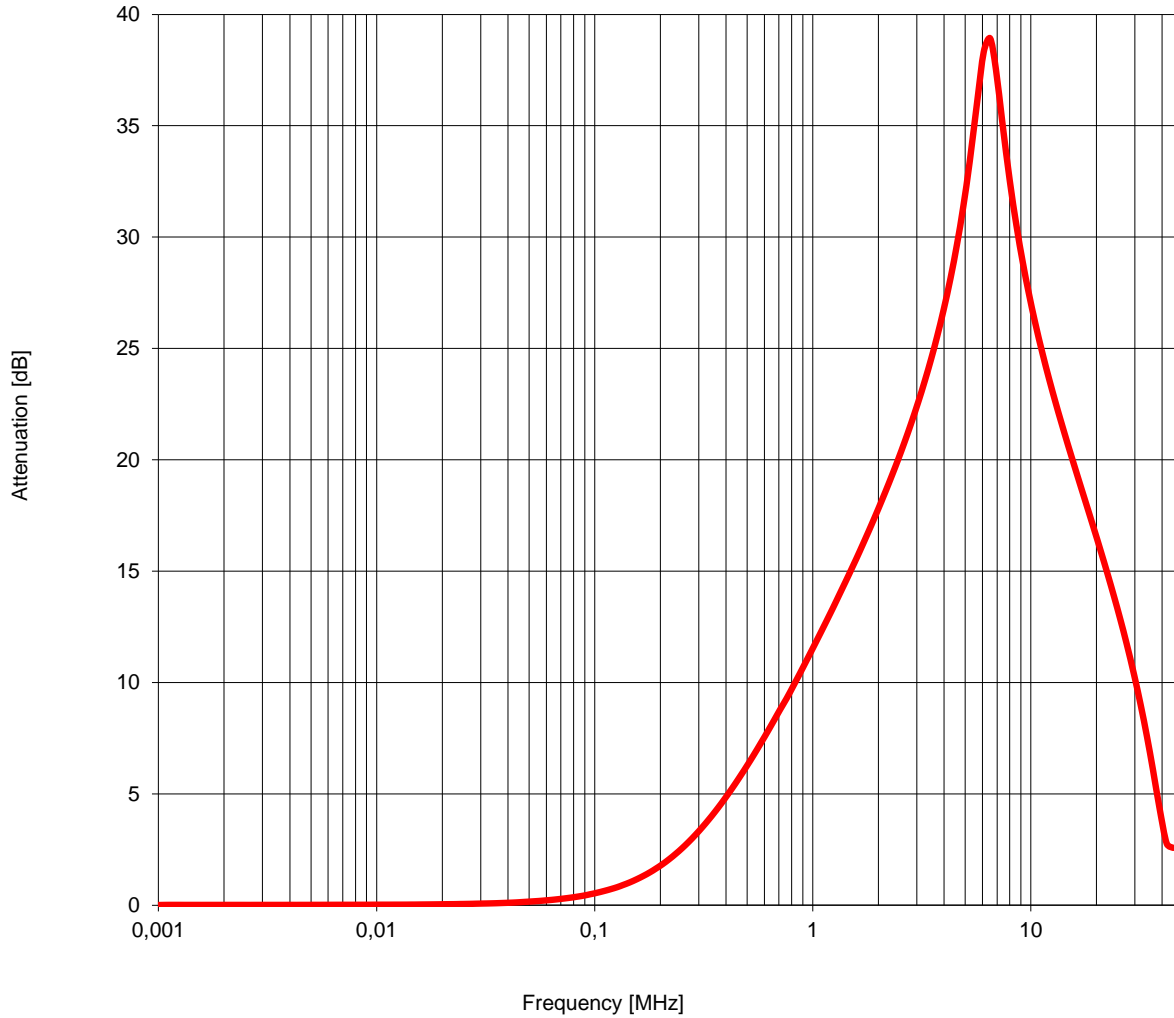

Freigabe erteilt / general release:	Kunde / customer			
Datum / date	Unterschrift / signature			
	Würth Elektronik	HasA	Version 3	15-07-23
		HasA	Version 2	15-03-05
		HasA	Version 1	14-04-15
Geprüft / checked	Kontrolliert / approved	Name	Änderung / modification	Datum / date

Würth Elektronik eiSos GmbH & Co.KG

D-74638 Waldenbug · Max-Eyth-Strasse 1 - 3 · Germany · Telefon (+49) (0) 7942 - 945 - 0 · Telefax (+49) (0) 7942 - 945 - 400
<http://www.we-online.com>