

GaAs MMIC I/Q MIXER DOWNCONVERTER, 10 - 16 GHz

Typical Applications

The HMC1113LP5E is ideal for:

- Point-to-Point and Point-to-Multi-Point Radios
- Military Radar, EW & ELINT
- Satellite Communications
- Maritime & Mobile Radios

Features

- Conversion Gain: 12 dB
- Image Rejection: 25 dBc
- LO to RF Isolation: 45 dB
- Noise Figure: 1.8 dB
- Input IP3: 1 dBm
- 32 Lead 5 x 5 mm SMT Package

Functional Diagram

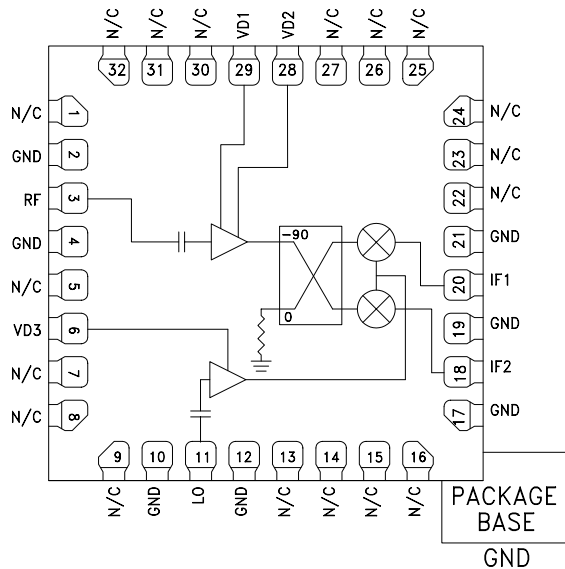

General Description

The HMC1113LP5E is a compact GaAs MMIC I/Q downconverter in a leadless 5 x 5 mm low stress injection molded plastic surface mount package. This device provides a small signal conversion gain of 12 dB with a noise figure of 1.8 dB and 25 dBc of image rejection. The HMC1113LP5E utilizes an LNA followed by an image reject mixer which is driven by an LO buffer amplifier. The image reject mixer eliminates the need for a filter following the LNA, and removes thermal noise at the image frequency. I/Q mixer outputs are provided and an external 90° hybrid is needed to select the required sideband. The HMC1113LP5E is a much smaller alternative to hybrid style image reject mixer downconverter assemblies, and it eliminates the need for wire bonding by allowing the use of surface mount manufacturing techniques.

Electrical Specifications, $T_A = +25\text{ }^\circ\text{C}$, IF = 500 MHz, LO = 6 dBm, VD1 = VD2 = 3V, VD3 = 4V, USB [1]

Parameter	Min.	Typ.	Max.	Min.	Typ.	Max.	Units
RF Frequency Range		10 - 12		12 - 16			GHz
IF Frequency Range		DC - 3.5		DC - 3.5			GHz
Conversion Gain	9	12		9	12		dB
Noise Figure		1.8	2.5		1.8	2.5	dB
Image Rejection	17	22		18	25		dBc
1 dB Compression (Input)		-7			-7		dBm
LO to RF Isolation	35	45		25	35		dB
LO to IF Isolation		22			15		dB
IP3 (Input)		0.5			1		dBm
Amplitude Balance [2]		±1			±1		dB
Phase Balance [2]		±6			±6		Deg
Supply Current (ID1 + ID2)		60	80		60	80	mA
Supply Current (ID3)		100	120		100	120	mA

[1] Unless otherwise noted all measurements performed as downconverter.

[2] Measurements taken without external 90° hybrid.

Information furnished by Analog Devices is believed to be accurate and reliable. However, no responsibility is assumed by Analog Devices for its use, nor for any infringements of patents or other rights of third parties that may result from its use. Specifications subject to change without notice. No license is granted by implication or otherwise under any patent or patent rights of Analog Devices. Trademarks and registered trademarks are the property of their respective owners.

For price, delivery, and to place orders: Analog Devices, Inc.,
One Technology Way, P.O. Box 9106, Norwood, MA 02062-9106
Phone: 781-329-4700 • Order online at www.analog.com
Application Support: Phone: 1-800-ANALOG-D

**GaAs MMIC I/Q MIXER
DOWNCONVERTER, 10 - 16 GHz**

**Data Taken as SSB Downconverter with External IF 90° Hybrid, IF = 500 MHz, USB
Input P1dB vs. Temperature**

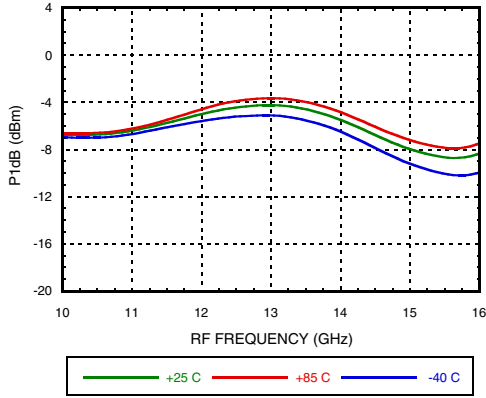

Input P1dB vs. LO Power

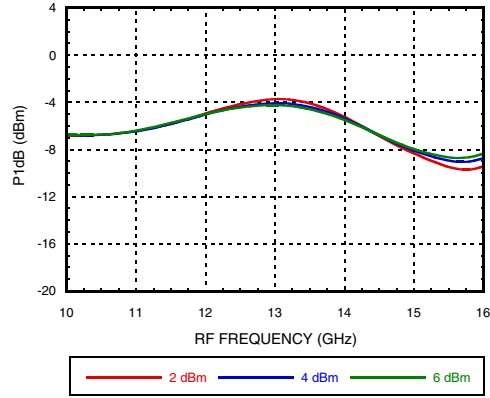

**Noise Figure vs. Temperature
IF = 500 MHz**

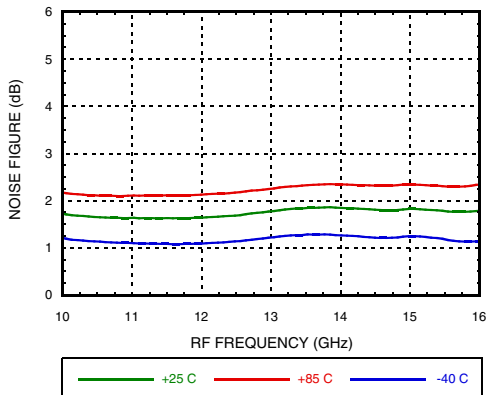

**Noise Figure vs. LO Power
IF = 500 MHz**

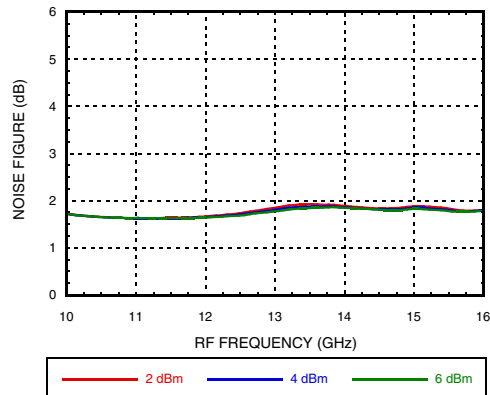

**Noise Figure vs. Temperature
LO = 12 GHz**

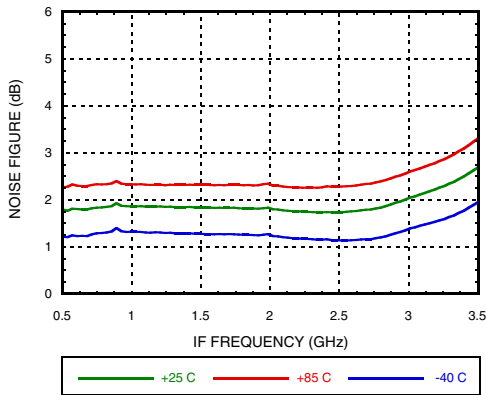

**Noise Figure vs. LO Power
LO = 12 GHz**

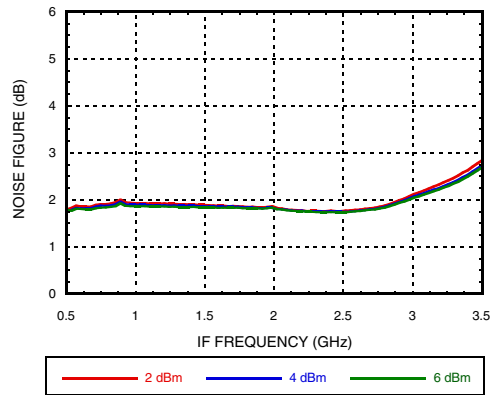

**GaAs MMIC I/Q MIXER
DOWNCONVERTER, 10 - 16 GHz**

Data Taken as SSB Downconverter with External IF 90° Hybrid, IF = 500 MHz, USB
Noise Figure vs. IF Frequency

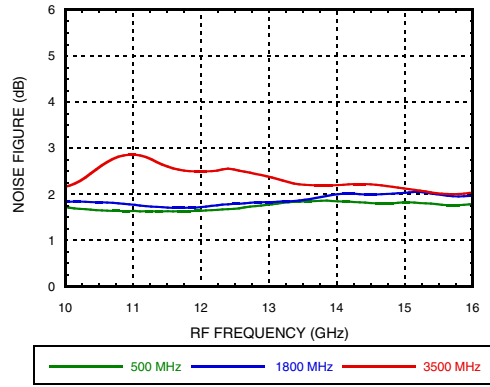

Isolations [1]

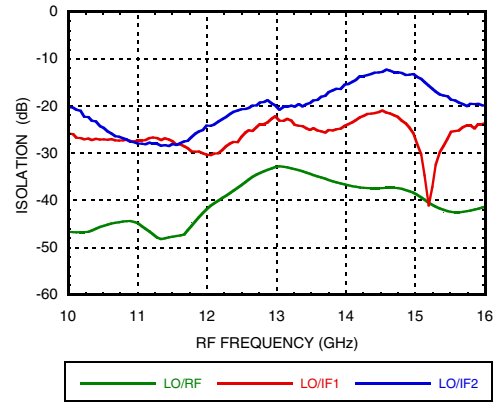

Amplitude Balance vs. LO Power [1]

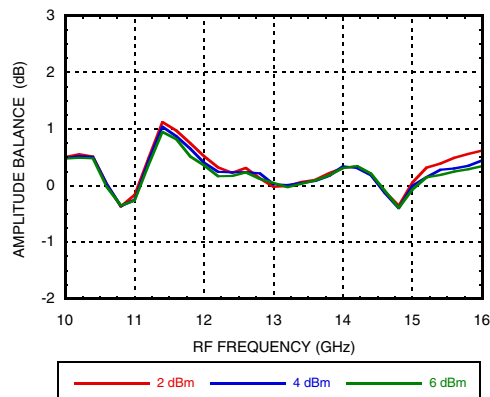

Phase Balance vs. LO Power [1]

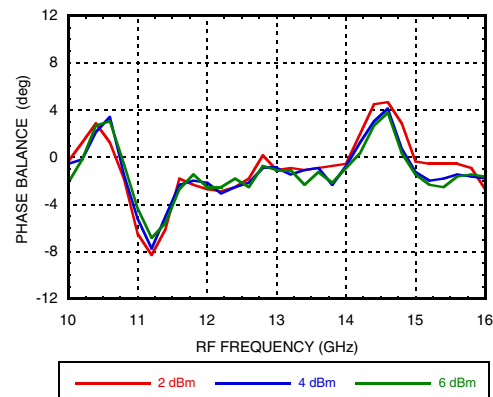

IF Bandwidth

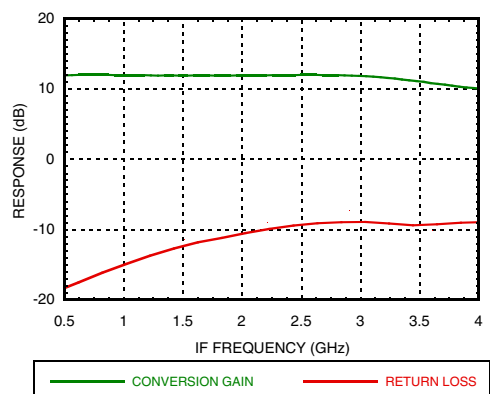

Return Loss [1]

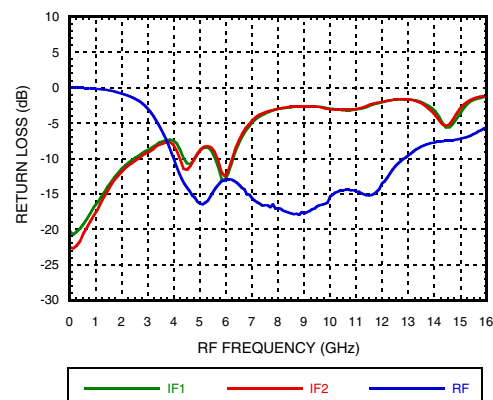

[1] Measurement taken without external 90° hybrid.

**GaAs MMIC I/Q MIXER
DOWNCONVERTER, 10 - 16 GHz**

Data Taken as SSB Downconverter with External IF 90° Hybrid, IF = 2000 MHz, USB
Conversion Gain vs. Temperature **Conversion Gain vs. LO Drive**

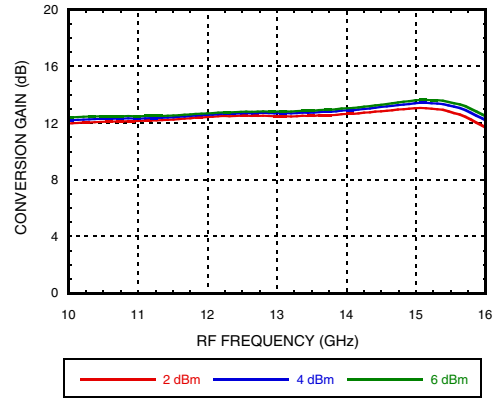
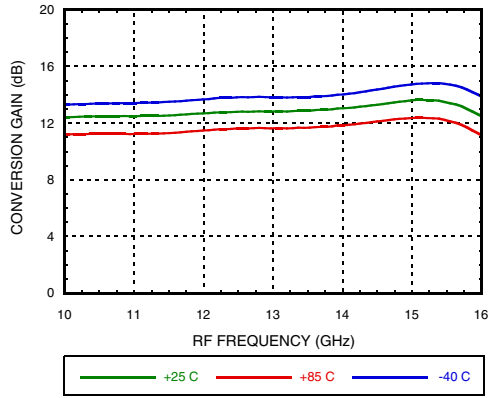

Image Rejection vs. Temperature

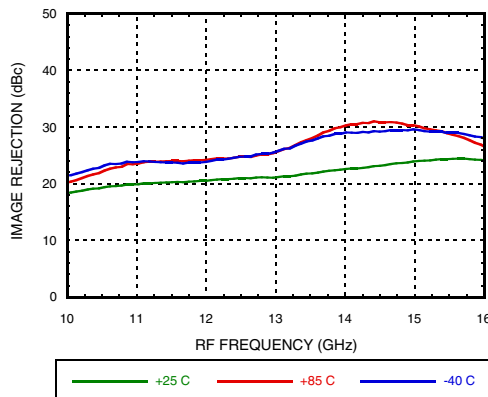
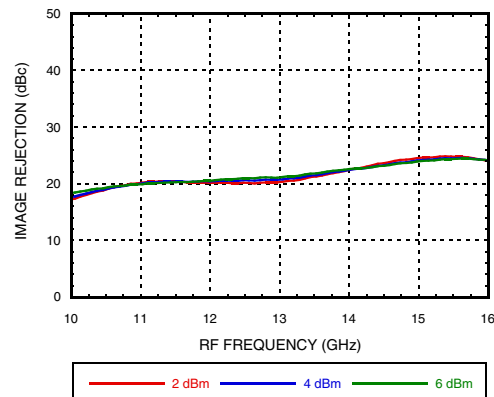
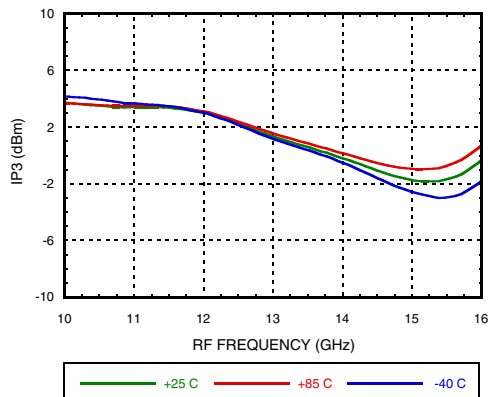

Image Rejection vs. LO Drive



Input IP3 vs. Temperature



Input IP3 vs. LO Power

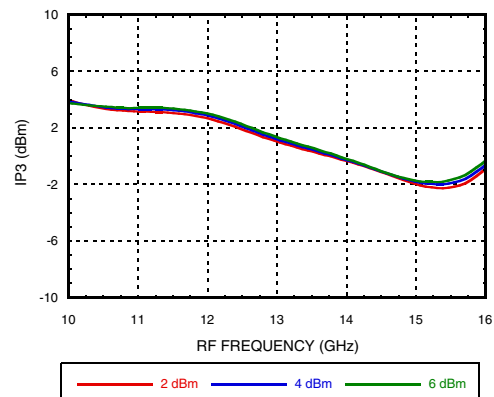

**GaAs MMIC I/Q MIXER
DOWNCONVERTER, 10 - 16 GHz**

**Data Taken as SSB Downconverter with External IF 90° Hybrid, IF = 1800 MHz, USB
Noise Figure vs. Temperature
IF = 1800 MHz**

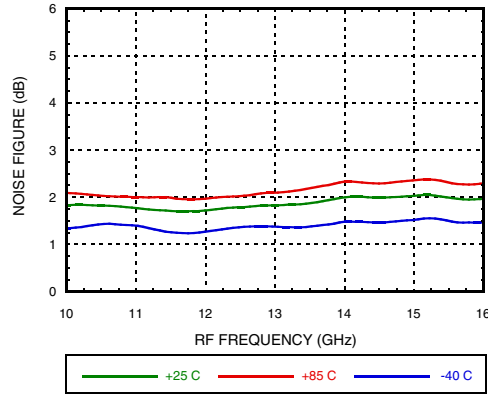

**GaAs MMIC I/Q MIXER
DOWNCONVERTER, 10 - 16 GHz**

Data Taken as SSB Downconverter with External IF 90° Hybrid, IF = 3500 MHz, USB
Conversion Gain vs. Temperature

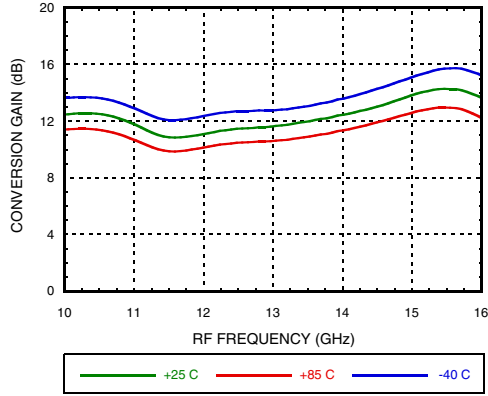

Conversion Gain vs. LO Drive

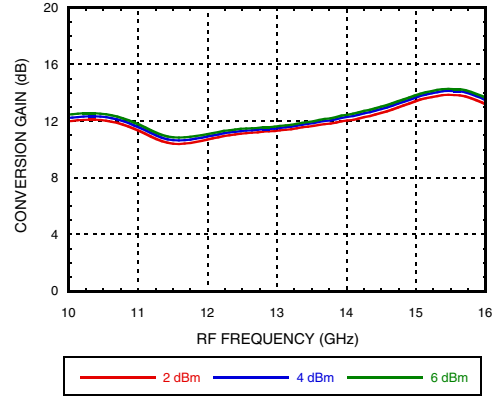

Image Rejection vs. Temperature

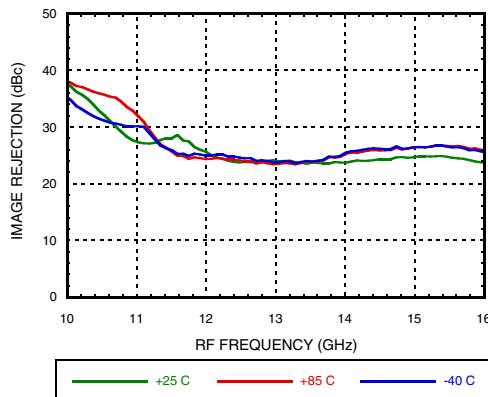
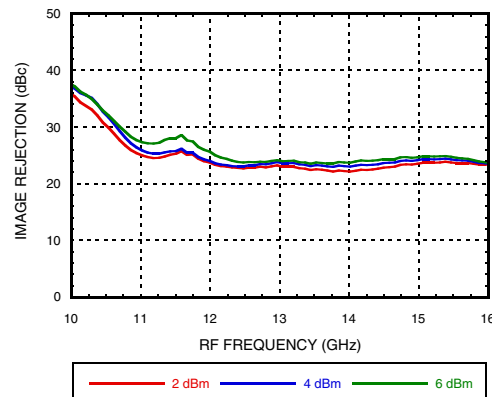
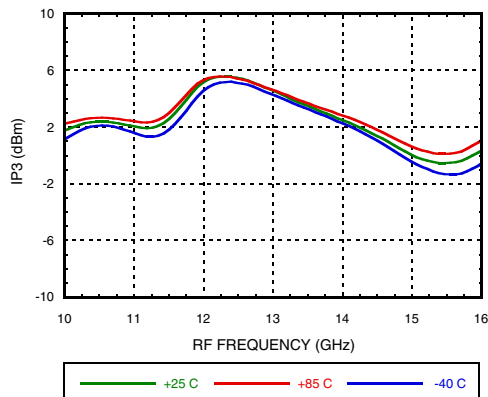

Image Rejection vs. LO Drive



Input IP3 vs. Temperature



Input IP3 vs. LO Power

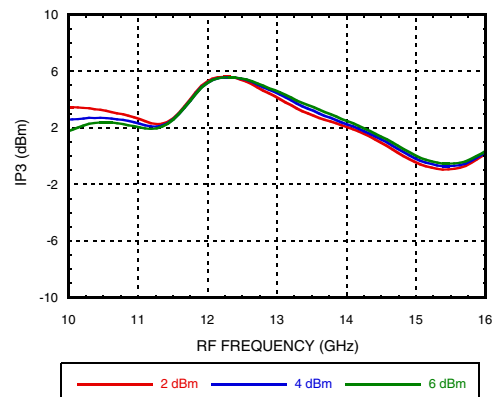

**GaAs MMIC I/Q MIXER
DOWNCONVERTER, 10 - 16 GHz**

Data Taken as SSB Downconverter with External IF 90° Hybrid, IF = 3500 MHz, USB
Noise Figure vs. Temperature
IF = 3500 MHz

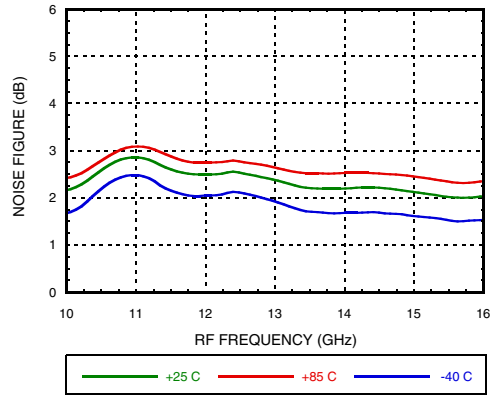

Noise Figure vs. LO Power
IF = 3500 MHz

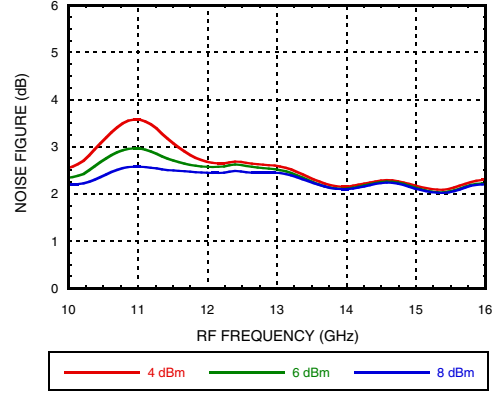

GaAs MMIC I/Q MIXER DOWNCONVERTER, 10 - 16 GHz

Pin Descriptions

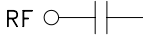
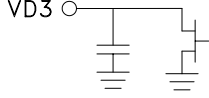
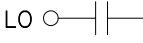
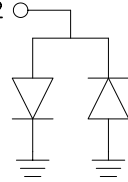
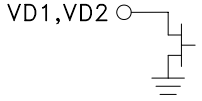
Pin Number	Function	Description	Interface Schematic
1, 5, 7, 8, 9, 13, 14, 15, 16, 22, 23, 24, 25, 26, 27, 30, 31, 32	N/C	These pins are not connected internally. However, all data shown herein was measured with these pins connected to RF/DC ground externally.	
2, 4, 10, 12, 17, 19, 21	GND	These pins and the exposed ground paddle must be connected to RF/DC ground.	
3	RF	This pin is AC coupled and matched to 50 Ohms.	
6	VD3	Power Supply for LO amplifier.	
11	LO	This pin is AC coupled and matched to 50 Ohms.	
18	IF2	Differential IF input pins. For applications not requiring operation to DC, an off chip DC blocking capacitor should be used. For operation to DC this pin must not source/sink more than 3 mA of current or part non function and possible part failure will result.	
20	IF1		
28, 29	VD2, VD1	Voltage bias for LNA.	

GaAs MMIC I/Q MIXER DOWNCONVERTER, 10 - 16 GHz

Absolute Maximum Ratings

RF Input	+8 dBm
LO Input	+10 dBm
VD1, VD2	+4.5V
VD3	+4.5V
Channel Temperature	175 °C
Continuous Pdiss (T = 85 °C) (derate 11.84 mW/°C above 85 °C)	1.066 W
Thermal Resistance (channel to ground paddle)	84.64 °C/W
Storage Temperature	-65 to +150 °C
Operating Temperature	-40 to +85 °C
ESD Sensitivity (HBM)	Class 0, passed 150 V



ELECTROSTATIC SENSITIVE DEVICE
OBSERVE HANDLING PRECAUTIONS

Outline Drawing

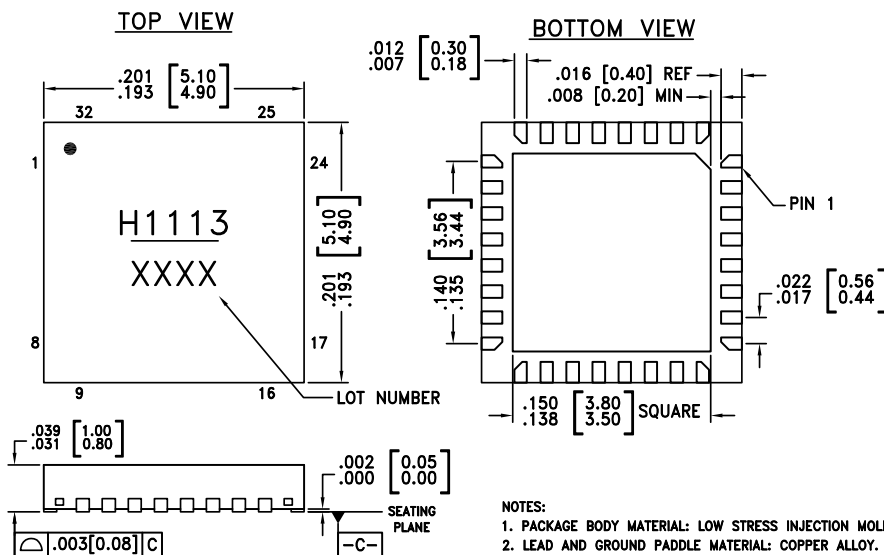

NOTES:

1. PACKAGE BODY MATERIAL: LOW STRESS INJECTION MOLDED PLASTIC SILICA AND SILICON IMPREGNATED.
2. LEAD AND GROUND PADDLE MATERIAL: COPPER ALLOY.
3. LEAD AND GROUND PADDLE PLATING: 100% MATTE TIN.
4. DIMENSIONS ARE IN INCHES [MILLIMETERS].
5. LEAD SPACING TOLERANCE IS NON-CUMULATIVE.
6. CHARACTERS TO BE HELVETICA MEDIUM, .025 HIGH, WHITE INK, OR LASER MARK LOCATED APPROX. AS SHOWN.
7. PAD BURR LENGTH SHALL BE 0.15mm MAX. PAD BURR HEIGHT SHALL BE 0.25mm MAX.
8. PACKAGE WARP SHALL NOT EXCEED 0.05mm
9. ALL GROUND LEADS AND GROUND PADDLE MUST BE SOLDERED TO PCB RF GROUND.
10. REFER TO HITTITE APPLICATION NOTE FOR SUGGESTED PCB LAND PATTERN.

Package Information

Part Number	Package Body Material	Lead Finish	MSL Rating ^[2]	Package Marking ^[1]
HMC1113LP5E	RoHS-compliant Low Stress Injection Molded Plastic	100% matte Sn	MSL3	H1113 XXXX

[1] 4-Digit lot number XXXX

[2] Max peak reflow temperature of 260 °C

**GaAs MMIC I/Q MIXER
DOWNCONVERTER, 10 - 16 GHz**

Application Circuit

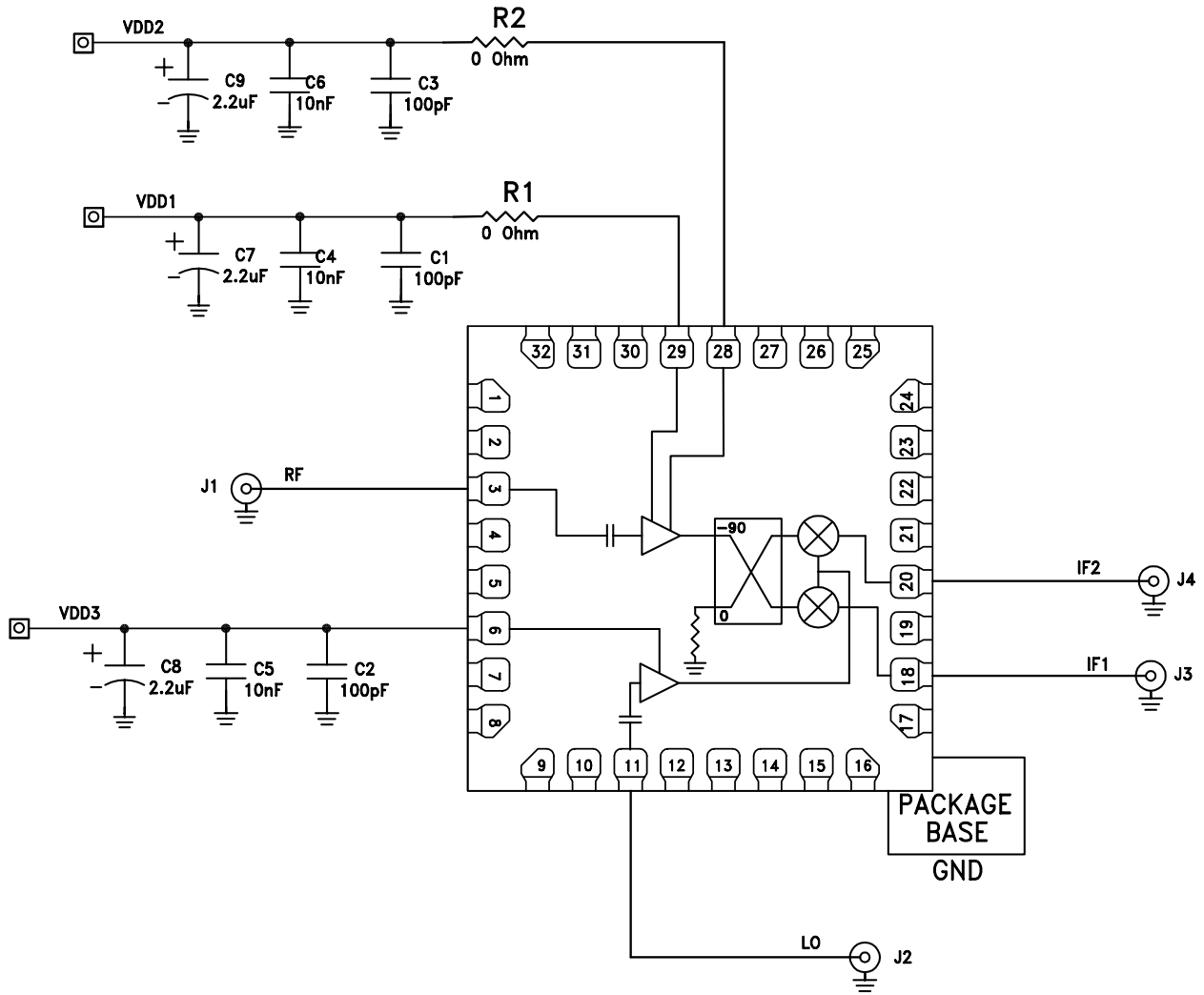

GaAs MMIC I/Q MIXER DOWNCONVERTER, 10 - 16 GHz

Evaluation PCB

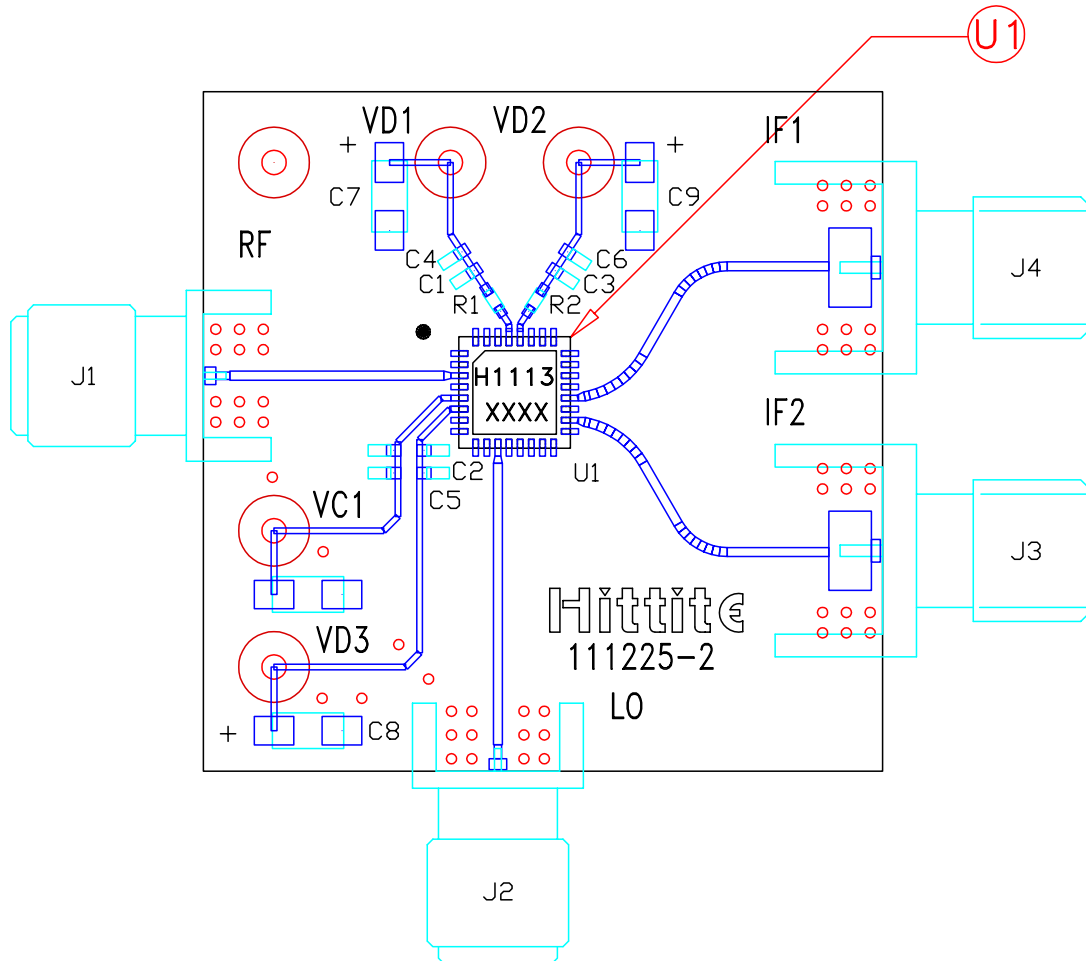

List of Materials for Evaluation PCB EV1HMC1113LP5^[1]

Item	Description
J1 - J2	SCD, COMP, SMA Connector, SRI
J3 - J4	SCD, COMP, SMA Connector, JOHNSON
C1 - C3	100 pF Capacitor, 0402 Pkg.
C4 - C6	10000 pF Capacitor, 0402 Pkg.
C7 - C9	2.2 uF Capacitor, CAP TANT.
R1 - R2	0 Ohm Resistor, 0402 Pkg.
U1	HMC1113LP5E
PCB ^[1]	111225 Evaluation Board

[1] Circuit Board Material: Rogers 4350 or Arlon 25FR

The circuit board used in the application should use RF circuit design techniques. Signal lines should have 50 Ohm impedance while the package ground leads and exposed paddle should be connected directly to the ground plane similar to that shown. A sufficient number of via holes should be used to connect the top and bottom ground planes. The evaluation circuit board shown is available from Hittite upon request.