

## Description

This document describes the specifications for the F1792 Wideband, Gain-Settable, Zero-Distortion™ Flat-Noise™, RF to IF Downconverting Mixer.

The F1792 offers very low power consumption with excellent linearity. In addition to this the F1792 has four dynamically adjustable gain settings. The F1792 performance is exceptional across an extremely broad range of RF and IF frequencies. All of this makes it ideal for a myriad of applications including:

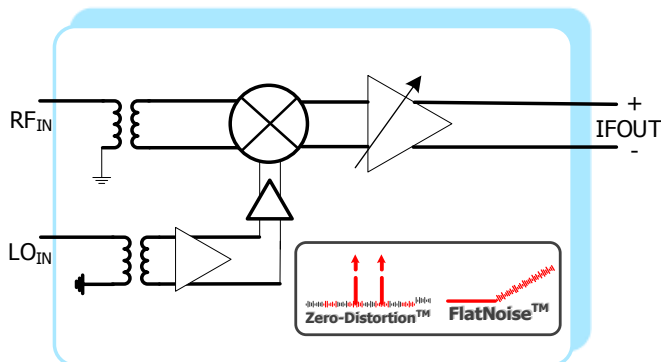
- 2G/3G/4G/5G/Multimode Remote Radio Units
- Point to Point  $\mu$ Wave Backhaul systems
- Broadband Repeaters
- Public Safety Infrastructure
- Any radio system operating between 400 MHz and 4000 MHz

## Competitive Advantage

F1792 offers maximum performance and flexibility at minimum power consumption. The unique and patented settable-gain feature allows it to be used in a very wide variety of radio card applications, even allowing for dynamic adjustment of gain to maximize performance on the fly. The extremely wide RF and IF bandwidths are achieved using a fixed BOM, all RF matching is internal to the device. The F1792 can function with as little as -6 dBm LO power. It also features a channel shutdown mode for ease of integration into high order TDD systems.

## Block Diagram

Figure 1. Functional Block Diagram



## Features

- RF range: 400MHz to 3800MHz
- LO range: 400MHz to 3600MHz
- IF Range: 50MHz to 600MHz
- 4 Gain Settings; 11dB, 8dB, 5dB, 2dB
- 2 bit gain step control
- Ideal for Multi-Carrier Systems
- +35dBm OIP3
- Low Noise Figure at any gain setting via IDT's FlatNoise™ technology
- Z = 200  $\Omega$  IF balanced, 50  $\Omega$  RF, 50  $\Omega$  LO single ended
- All internally matched. Single BOM for all RF, LO and IF frequencies
- 4 mm x 4 mm, 24-pin TQFN package
- Independent Path Standby mode
- 75 nsec settling for gain adjustment
- VCC = 3.3V, 462 mW, 373 mW (low power mode)

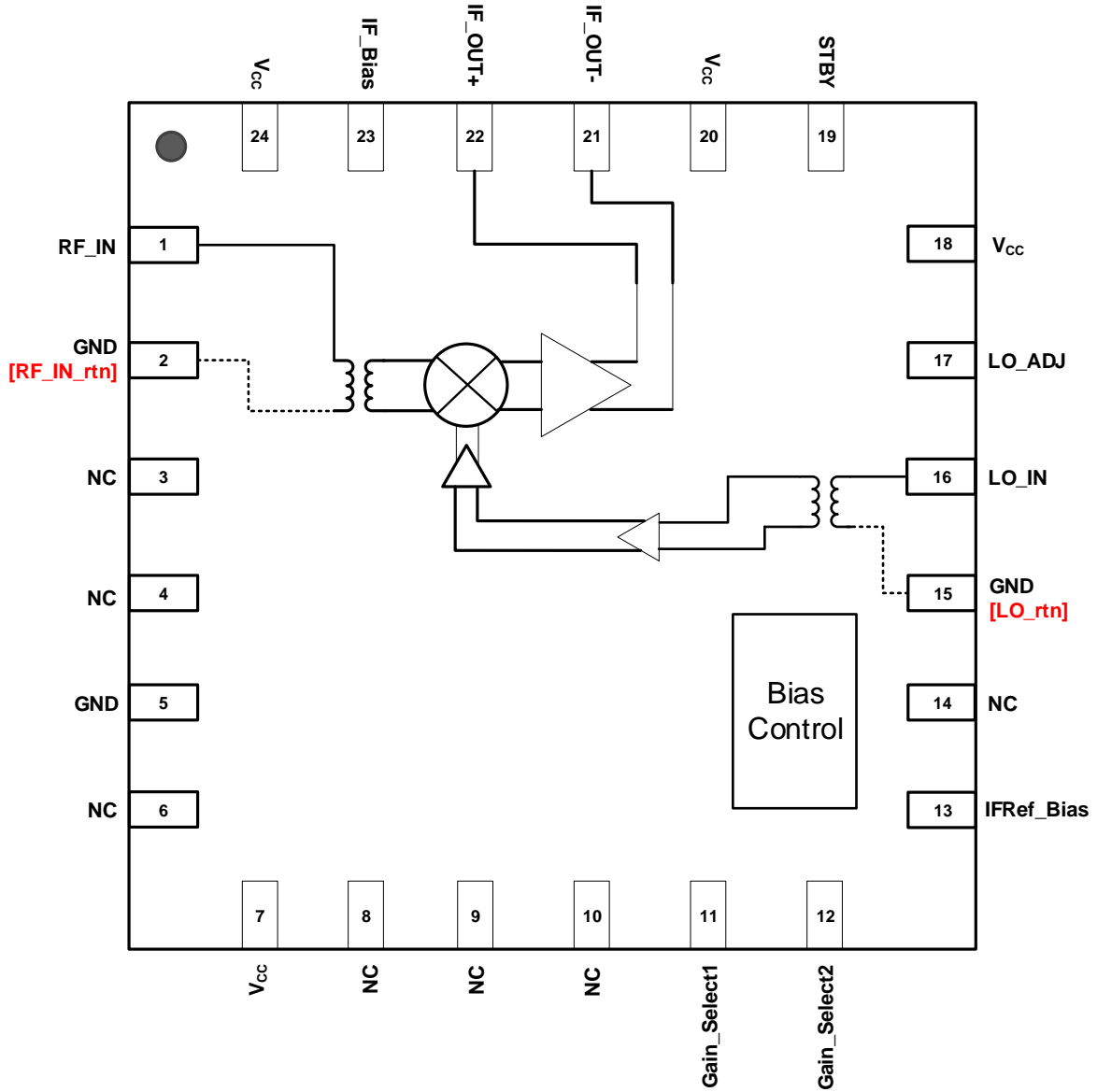
## Band Performance Summary

| RF Frequency (MHz)         | 900  | 1900 | 2600 | 3500 |
|----------------------------|------|------|------|------|
| Gain (dB, max G11 setting) | 11.0 | 10.8 | 10.3 | 9.0  |
| Gain (dB, min G2 setting)  | 2.5  | 2.3  | 1.8  | 0.5  |
| NF @ max gain (dB)         | 8.9  | 8.7  | 10.0 | 10.9 |
| IIP3 @ min gain (dBm)      | 28   | 27   | 29   | 30   |
| OIP3 @ G8 (dBm)            | 37   | 34   | 35   | 35   |
| IP1dB @ min gain (dBm)     | 13.6 | 14.7 | 14.6 | 15.8 |
| Pdiss (mW)                 | 442  | 462  | 485  | 520  |

# Pin Assignments

Figure 2. Pin Assignments for 4 x 4 mm 24-pin-TQFN Package – Top View

Red denotes internal connection



## Pin Descriptions

**Table 1. F1792 Pin Descriptions**

| Number                   | Name                | Description   |
|--------------------------|---------------------|---|
| 1                        | RF_IN               | RF input. Matched to 50 ohms. DO NOT apply DC to this pin.  |
| 2                        | RF_IN_rtn           | RF input transformer ground return. Ground this pin.  |
| 3, 4, 6, 8, 9,<br>10, 14 | NC                  | Not connected.  |
| 5                        | GND                 | Ground this pin.  |
| 7, 18, 20, 24            | VCC                 | Power Supply. Bypass to ground with appropriate capacitors as close as possible to pin  |
| 11                       | Gain_Select1        | Gain select control pin, includes internal pull-down resistor. See gain select truth table for desired setting  |
| 12                       | Gain_Select2        | Gain select control pin, includes internal pull-down resistor. See gain select truth table for desired setting  |
| 13                       | IFRef_Bias          | Connect recommended resistor value from this pin to ground to set the IF amplifier reference current  |
| 15                       | LO_IN_rtn           | LO input transformer ground return. Ground this pin.  |
| 16                       | LO_IN               | Local Oscillator (LO) input. Matched to 50 ohms. DO NOT apply DC to this pin.   |
| 17                       | LO_ADJ              | Connect zero ohm resistor to ground here for best performance   |
| 19                       | STBY                | Standby Input (Low/Open = Power ON, High = Power OFF). Includes internal pull-down resistor   |
| 21, 22                   | IF_OUT-,<br>IF_OUT+ | Mixer Differential IF Output. Connect pull-up inductors from each of these pins to VCC (see the Typical Application Circuit)  |
| 23                       | IF_Bias             | Connect the specified resistor from this pin to ground to set the bias for the Main IF amplifier  |
|                          | — EP                | Exposed Pad. Internally connected to GND. Solder this exposed pad to a PCB pad that uses multiple ground vias to provide heat transfer out of the device into the PCB ground planes. These multiple via grounds are also required to achieve the specified RF performance |

## Absolute Maximum Ratings

**Table 2. Absolute Maximum Ratings**

| Parameter   | Symbol             | Conditions              | Minimum | Maximum              | Units |
|---|--------------------|-------------------------|---------|----------------------|-------|
| VCC to GND  | V <sub>CC</sub>    |                         | -0.5    | +3.6                 | V     |
| STBY, Gain_Select1, Gain_Select2, RF_IN, LO1_ADJ, LO2_ADJ | V <sub>CTRL</sub>  |                         | -0.5    | V <sub>CC</sub> +0.5 | V     |
| IF_OUT+, IF_OUT-  | IF <sub>OUT</sub>  |                         | 2.4     | V <sub>CC</sub> +0.5 | V     |
| LO_IN   | LO <sub>IN</sub>   |                         | -0.5    | +0.5                 | V     |
| IF_Bias   | IF <sub>BIAS</sub> |                         |         | 50                   | Ohms  |
| IF_Ref_Bias   | IF <sub>REF</sub>  |                         |         | 500                  | Ohms  |
| RF Input Power  | RF <sub>MAX</sub>  | continuous              |         | 20                   | dBm   |
| LO Input Power  | LO <sub>MAX</sub>  | continuous              |         | 20                   | dBm   |
| Continuous Power Dissipation                              | P <sub>DISS</sub>  |                         |         | 1.5                  | W     |
| Junction temperature                                      | T <sub>J</sub>     | -                       | -       | 150                  | °C    |
| Storage temperature                                       | T <sub>S</sub>     | -                       | -65     | 150                  | °C    |
| Lead temperature  | T <sub>LEAD</sub>  | (soldering, 10 seconds) |         | 260                  | °C    |
| ESD – Human Body Model (JEDEC/ESDA JS-001-2012)           | -                  | -                       | -       | Class 2 (2500)       | V     |
| ESD – Charged Device Model (JEDEC 22-C101F)               | -                  | -                       | -       | Class C3 (1000)      | V     |

Stresses above those listed above may cause permanent damage to the device. Functional operation of the device at these or any other conditions above those indicated in the operational section of this specification is not implied. Exposure to absolute maximum rating conditions for extended periods may affect device reliability

## Recommended Operating Conditions

**Table 3. Recommended Operating Conditions**

| Parameter                             | Symbol            | Minimum | Typical | Maximum | Units |
|---------------------------------------|-------------------|---------|---------|---------|-------|
| Power supply voltage                  | V <sub>CC</sub>   | 3.15    | -       | 3.45    | V     |
| Operating temperature range           | T <sub>CASE</sub> | -40     | -       | 105     | °C    |
| RF Frequency Range                    | F <sub>RF</sub>   | 400     |         | 3800    | MHz   |
| Local Oscillator (LO) Frequency Range | F <sub>LO</sub>   | 400     |         | 3600    | MHz   |
| Intermediate Frequency (IF) Range     | F <sub>IF</sub>   | 50      |         | 600     | MHz   |
| Local oscillator power level          | P <sub>LO</sub>   | -6      |         | +6      | dBm   |

## Electrical Characteristics

**Table 4. IDTF1792 Specification (General)**

Typical Application Circuit,  $V_{CC} = +3.3V$ ,  $T_C = +25^\circ C$ ,  $F_{RF} = 900MHz$ ,  $F_{IF} = 199MHz$ ,  $F_{LO} = 1099MHz$ ,  $P_{LO} = 0\text{ dBm}$ ,  $P_{IN} = -10\text{dBm}$  per tone for all gain settings unless otherwise stated, STBY = LOW. EVkit IF transformer losses are de-embedded unless otherwise noted.

| Parameter                          | Symbol           | Conditions   | Minimum     | Typical | Maximum     | Units    |
|------------------------------------|------------------|--|-------------|---------|-------------|----------|
| Logic Input High <sup>3</sup>      | $V_{IH}^3$       | -  | <b>1.1'</b> |         |             | V        |
| Logic Input Low <sup>3</sup>       | $V_{IL}^3$       | Minimum attenuation  |             |         | <b>0.65</b> | V        |
| Logic Current                      | $I_{IH}, I_{IL}$ | For all control pins   | <b>-5</b>   |         | <b>+100</b> | mA       |
| Supply Current                     | $I_{CH\_LB}$     | Low band LO  |             | 134     | <b>154</b>  | mA       |
| Supply Current                     | $I_{CH\_MB}$     | Mid band LO  |             | 140     | <b>160</b>  | mA       |
| Supply Current                     | $I_{CH\_HB}$     | High band LO   |             | 147     | <b>166</b>  | mA       |
| Supply Current – reduced linearity |                  | FRF = 2.2GHz, FLO = 2GHz<br>OIP3 = +20dBm max gain<br>IFRef_Bias resistor = 3.9Kohm  |             | 113     | <b>135</b>  | mA       |
| Shutdown current                   | $I_{SD}$         |  |             | 3       | <b>6</b>    | mA       |
| Settling Time                      | $T_{SETT}$       | Pin = -13 dBm<br>Gate STBY pin<br>Time for IF Signal to settle from 50%<br>STBY to within 90% of final value   |             | 340     |             | nsec     |
|                                    |                  | Pin = -13 dBm<br>Gate STBY pin<br>Time for IF Signal to settle from 50%<br>STBY to within 0.1 dB of final value  |             | 920     |             | nsec     |
|                                    |                  | Pin = -13 dBm<br>Gate Gain Select pins per Gain<br>Control table<br>Time for IF Signal to settle from 50%<br>Gain Select to within 90% of final<br>value |             | 75      |             | nsec     |
| RFIN Impedance                     | $Z_{RFIN}$       | Single Ended   |             | 50      |             | $\Omega$ |
| LO Port Impedance                  | $Z_{LO}$         | Single Ended   |             | 50      |             | $\Omega$ |
| IF Output Impedance                | $Z_{IF}$         | Differential   |             | 200     |             | $\Omega$ |
| IF Return Loss                     | $RL_{IF}$        | Differential 200 ohm with 4:1 Balun  |             | -15     |             | dB       |
| LO Return Loss                     | $RL_{LO}$        | Single Ended 50 ohm  |             | -15     |             | dB       |

NOTE 1: Items in min/max columns in **bold italics** are Guaranteed by Test.

NOTE 2: Items in min/max columns that are not bold/italics are Guaranteed by Design Characterization.

NOTE 3: JEDEC 3.3V and JEDEC 1.8V logic

**Table 5. IDTF1792 Specification (Low Band)**

Typical Application Circuit,  $V_{CC} = +3.3V$ ,  $T_C = +25^\circ C$ ,  $F_{RF} = 900MHz$ ,  $F_{IF} = 199MHz$ ,  $F_{LO} = 1099MHz$ ,  $P_{LO} = 0\text{ dBm}$ ,  $P_{IN} = -10\text{dBm}$  per tone for all gain settings unless otherwise stated,  $STBY = LOW$ . EVkit IF transformer losses are de-embedded unless otherwise noted. Gain Setting =  $G_5$  (~ 5 dB gain).

| Parameter                | Symbol               | Conditions   | Minimum     | Typical     | Maximum           | Units  |
|--------------------------|----------------------|--|-------------|-------------|-------------------|--------|
| Power Gain               | $G_{11}$             | Gain setting = $G_{11}$                            |             | 11.1        |                   | dB     |
|                          | $G_8$                | Gain setting = $G_8$                               |             | 8.3         |                   |        |
|                          | $G_5$                | Gain setting = $G_5$                               | <b>4.05</b> | 5.4         | <b>6.75'</b>      |        |
|                          | $G_2$                | Gain setting = $G_2$                               |             | 2.5         |                   |        |
| G5 Gain Change over temp | $G5_{TempDrift}$     | Tcase -40C / +105C referenced to +25C              |             | -0.7 / +0.7 |                   | dB     |
| Gain Slope               | $Gain_{SLOPE}$       | IF center 200MHz<br>100MHz BW                      |             | +0.006      |                   | dB/MHz |
| Noise Figure             | $NF_{G11}$           | Gain setting = $G_{11}$                            |             | 8.9         |                   | dB     |
|                          | $NF_{G8}$            | Gain setting = $G_8$                               |             | 9.4         |                   |        |
|                          | $NF_{G5}^{4,5}$      | Gain setting = $G_5$                               |             | 10.1        | 11.7 <sup>2</sup> |        |
|                          | $NF_{G2}$            | Gain setting = $G_2$                               |             | 10.7        |                   |        |
| Input IP3                | $IIP3_{G11}$         | Gain setting = $G_{11}$<br>800 kHz tone separation |             | 24          |                   | dBm    |
|                          | $IIP3_{G8}$          | Gain setting = $G_8$<br>800 kHz tone separation    |             | 29          |                   |        |
|                          | $IIP3_{G5}^4$        | Gain setting = $G_5$<br>800 kHz tone separation    | 26          | 28          |                   |        |
|                          | $IIP3_{G2}$          | Gain setting = $G_2$<br>800 kHz tone separation    |             | 28          |                   |        |
| G3 IIP3 change over temp | $IIP3_{G3TempDrift}$ | Tcase -40C / +105C referenced to +25C              |             | -2.6/+0.6   |                   | dB     |
| Output IP3               | $OIP3_{G11}$         | Gain setting = $G_{11}$<br>800 kHz tone separation |             | 35          |                   | dBm    |
|                          | $OIP3_{G8}$          | Gain setting = $G_8$<br>800 kHz tone separation    |             | 37          |                   |        |

NOTE 1: Items in min/max columns in **bold italics** are Guaranteed by Test.

NOTE 2: Items in min/max columns that are not bold/italics are Guaranteed by Design Characterization.

NOTE 3: JEDEC 3.3V and JEDEC 1.8V logic

NOTE 4: Specification limits over voltage and temperature

NOTE 5: Max limit at Tcase = +105C

**Table 6. IDTF1792 Specification (Low Band) Continued**

Typical Application Circuit,  $V_{CC} = +3.3V$ ,  $T_C = +25^\circ C$ ,  $F_{RF} = 900MHz$ ,  $F_{IF} = 199MHz$ ,  $F_{LO} = 1099MHz$ ,  $P_{LO} = 0\text{ dBm}$ ,  $P_{IN} = -10\text{dBm}$  per tone for all gain settings unless otherwise stated,  $STBY = LOW$ . EVkit IF transformer losses are de-embedded unless otherwise noted. Gain Setting =  $G_5$  (~ 5 dB gain).

| Parameter                      | Symbol                           | Conditions   | Minimum | Typical | Maximum | Units |
|--------------------------------|----------------------------------|--|---------|---------|---------|-------|
| Output IP3                     | OIP3 <sub>G5</sub>               | Gain setting = $G_5$<br>800 kHz tone separation                                      |         | 32      |         | dBm   |
|                                |                                  | Gain setting = $G_5$<br>$T_C = +105^\circ C$<br>LO power = -3dBm<br>$V_{CC} = 3.15V$ | 33      | 34      |         |       |
|                                | OIP3 <sub>G2</sub>               | Gain setting = $G_2$<br>800 kHz tone separation                                      |         | 30      |         |       |
| Input P1dB                     | IP1dB <sub>G11</sub>             | Gain setting = $G_{11}$<br>IF_B Pout versus<br>IF_A w/ RF_A input                    |         | 7.0     |         | dB    |
|                                | IP1dB <sub>G8</sub>              | Gain setting = $G_8$   |         | 9.2     |         |       |
|                                | IP1dB <sub>G5</sub> <sup>4</sup> | Gain setting = $G_5$   | 10.4    | 11.8    |         |       |
|                                | IP1dB <sub>G2</sub>              | Gain setting = $G_2$   |         | 13.6    |         |       |
| Maximum saturated output power | $P_{sat}$                        | $P_{in}$ up to +20dBm  |         | 17      |         | dBm   |
| LO to IF leakage               | ISO <sub>LI</sub>                |  | 47      | 48      |         | dBm   |
| 2LO to IF leakage              | ISO <sub>LI2</sub>               |  |         | -38     | -35     | dBm   |
| 3LO to IF leakage              | ISO <sub>LI3</sub>               |  |         | -25     |         | dBm   |
| 4LO to IF leakage              | ISO <sub>LI4</sub>               |  |         | -49     |         | dBm   |
| RF to IF leakage               | ISO <sub>RI</sub>                | RF output power compared to measured<br>IF output power                              |         | -25     | -23     | dBc   |
| LO to RF leakage               | ISO <sub>LR</sub>                |  |         | -52     |         | dBm   |
| RF Return Loss                 | RL <sub>RF</sub>                 | Single Ended 50 ohm  |         | -12     |         | dB    |

NOTE 1: Items in min/max columns in **bold italics** are Guaranteed by Test.

NOTE 2: Items in min/max columns that are not bold/italics are Guaranteed by Design Characterization.

NOTE 3: JEDEC 3.3V and JEDEC 1.8V logic

NOTE 4: Specification limits over voltage and temperature

NOTE 5: Max limit at  $T_{case} = +105C$

**Table 7. IDTF1792 Specification (Mid Band)**

Typical Application Circuit,  $V_{CC} = +3.3V$ ,  $T_C = +25^\circ C$ ,  $F_{RF} = 1900MHz$ ,  $F_{IF} = 199MHz$ ,  $F_{LO} = 1701MHz$ ,  $P_{LO} = 0\text{ dBm}$ ,  $P_{IN} = -10\text{ dBm}$  per tone for all gain settings unless otherwise stated,  $STBY = LOW$ . EVkit IF transformer losses are de-embedded unless otherwise noted. Gain Setting =  $G_5$  (~ 5 dB gain).

| Parameter                | Symbol               | Conditions  | Minimum     | Typical     | Maximum           | Units  |
|--------------------------|----------------------|---|-------------|-------------|-------------------|--------|
| Power Gain               | $G_{11}$             | Gain setting = $G_{11}$   |             | 10.8        |                   | dB     |
|                          | $G_8$                | Gain setting = $G_8$  |             | 8.1         |                   |        |
|                          | $G_5$                | Gain setting = $G_5$  | <b>3.75</b> | 5.1         | <b>6.45'</b>      |        |
|                          | $G_2$                | Gain setting = $G_2$  |             | 2.3         |                   |        |
| G5 Gain Change over temp | $G5_{TempDrift}$     | Tcase -40C / +105C referenced to +25C                             |             | -0.6 / +0.7 |                   | dB     |
| Gain Slope               | $Gain_{SLOPE}$       | IF center 200MHz<br>100MHz BW                                     |             | +0.006      |                   | dB/MHz |
| Noise Figure             | $NF_{G11}$           | Gain setting = $G_{11}$   |             | 8.7         |                   | dB     |
|                          | $NF_{G8}$            | Gain setting = $G_8$  |             | 9.1         |                   |        |
|                          | $NF_{G5}^{4,5}$      | Gain setting = $G_5$  |             | 9.8         | 11.4 <sup>2</sup> |        |
|                          | $NF_{G2}$            | Gain setting = $G_2$  |             | 10.7        |                   |        |
| Blocking Noise Figure    | $NF_{BLK}$           | Gain setting = $G_{11}$<br>+100MHz offset blocker<br>Pin = +4 dBm |             | 17          |                   | dB     |
| Input IP3                | $IIP3_{G11}$         | Gain setting = $G_{11}$<br>800 kHz tone separation                |             | 23          |                   | dBm    |
|                          | $IIP3_{G8}$          | Gain setting = $G_8$<br>800 kHz tone separation                   |             | 25          |                   |        |
|                          | $IIP3_{G5}^4$        | Gain setting = $G_5$<br>800 kHz tone separation                   | 25          | 26          |                   |        |
|                          | $IIP3_{G2}$          | Gain setting = $G_2$<br>800 kHz tone separation                   |             | 27          |                   |        |
| G3 IIP3 change over temp | $IIP3_{G3TempDrift}$ | Tcase -40C / +105C referenced to +25C                             |             | -0.2/+5     |                   | dB     |
| Output IP3               | $OIP3_{G11}$         | Gain setting = $G_{11}$<br>800 kHz tone separation                |             | 33.6        |                   | dBm    |
|                          | $OIP3_{G8}$          | Gain setting = $G_8$<br>800 kHz tone separation                   |             | 33.6        |                   |        |

NOTE 1: Items in min/max columns in **bold italics** are Guaranteed by Test.

NOTE 2: Items in min/max columns that are not bold/italics are Guaranteed by Design Characterization.

NOTE 3: JEDEC 3.3V and JEDEC 1.8V logic

NOTE 4: Specification limits over voltage and temperature

NOTE 5: Max limit at Tcase = +105C



**Table 8. IDTF1792 Specification (Mid Band) Continued**

Typical Application Circuit,  $V_{CC} = +3.3V$ ,  $T_C = +25^\circ C$ ,  $F_{RF} = 1900MHz$ ,  $F_{IF} = 199MHz$ ,  $F_{LO} = 1701MHz$ ,  $P_{LO} = 0\text{ dBm}$ ,  $P_{IN} = -10\text{ dBm}$  per tone for all gain settings unless otherwise stated,  $STBY = LOW$ . EVkit IF transformer losses are de-embedded unless otherwise noted. Gain Setting =  $G_5$  (~ 5 dB gain).

| Parameter                      | Symbol         | Conditions   | Minimum    | Typical | Maximum    | Units |
|--------------------------------|----------------|--|------------|---------|------------|-------|
|                                | $OIP3_{G5}$    | Gain setting = $G_5$<br>800 kHz tone separation                                      | <b>29</b>  | 31.0    |            |       |
|                                |                | Gain setting = $G_5$<br>$T_C = +105^\circ C$<br>LO power = -3dBm<br>$V_{CC} = 3.15V$ | 28.8       | 29.5    |            |       |
|                                | $OIP3_{G2}$    | Gain setting = $G_2$<br>800 kHz tone separation                                      |            | 29.0    |            |       |
| Input P1dB                     | $IP1dB_{G11}$  | Gain setting = $G_{11}$  | <b>6.0</b> | 7.7     |            | dB    |
|                                | $IP1dB_{G8}$   | Gain setting = $G_8$   |            | 10.1    |            |       |
|                                | $IP1dB_{G5}^4$ | Gain setting = $G_5$   | 11.3       | 12.7    |            |       |
|                                | $IP1dB_{G2}$   | Gain setting = $G_2$   |            | 14.7    |            |       |
| Maximum saturated output power | $P_{sat}$      | $P_{in}$ up to +20dBm  |            | 17      |            | dBm   |
| LO to IF leakage               | $ISO_{LI}$     |  |            | -31     | <b>-22</b> | dBm   |
| 2LO to IF leakage              | $ISO_{LI2}$    |  |            | -20     |            | dBm   |
| 3LO to IF leakage              | $ISO_{LI3}$    |  |            | -59     |            | dBm   |
| 4LO to IF leakage              | $ISO_{LI4}$    |  |            | -44     |            | dBm   |
| RF to IF leakage               | $ISO_{RI}$     | RF output power compared to measured IF output power                                 |            | -25     | <b>-20</b> | dBc   |
| LO to RF leakage               | $ISO_{LR}$     |  |            | -46     |            | dBm   |
| RF Return Loss                 | $RL_{RF}$      | Single Ended 50 ohm  |            | -13     |            | dB    |

NOTE 1: Items in min/max columns in **bold italics** are Guaranteed by Test.

NOTE 2: Items in min/max columns that are not bold/italics are Guaranteed by Design Characterization.

NOTE 3: JEDEC 3.3V and JEDEC 1.8V logic

NOTE 4: Specification limits over voltage and temperature

NOTE 5: Max limit at  $T_{case} = +105C$

**Table 9. IDTF1792 Specification (High Band)**

Typical Application Circuit,  $V_{CC} = +3.3V$ ,  $T_C = +25^\circ C$ ,  $F_{RF} = 2600MHz$ ,  $F_{IF} = 199MHz$ ,  $F_{LO} = 2401MHz$ ,  $P_{LO} = 0 dBm$ ,  $P_{IN} = -10dBm$  per tone for all gain settings unless otherwise stated,  $STBY = LOW$ . EVkit IF transformer losses are de-embedded unless otherwise noted. Gain Setting =  $G_5$  (~ 5 dB gain).

| Parameter                | Symbol                          | Conditions  | Minimum     | Typical     | Maximum         | Units  |
|--------------------------|---------------------------------|---|-------------|-------------|-----------------|--------|
| Power Gain               | $G_{11}$                        | Gain setting = $G_{11}$   |             | 10.3        |                 | dB     |
|                          | $G_8$                           | Gain setting = $G_8$  |             | 7.5         |                 |        |
|                          | $G_5$                           | Gain setting = $G_5$  | <b>3.25</b> | 4.6         | <b>5.95'</b>    |        |
|                          |                                 | Gain setting = $G_5$<br>$F_{IF} = 469MHz$<br>$F_{LO} = 2130MHz$ | <b>2.4</b>  | 4.0         | <b>5.6</b>      |        |
|                          | $G_2$                           | Gain setting = $G_2$  |             | 1.8         |                 |        |
| G5 Gain Change over temp | $G5_{TempDrift}$                | Tcase -40C / +105C referenced to +25C                           |             | -0.7 / +0.7 |                 | dB     |
| Gain Slope               | Gain <sub>SLOPE1</sub>          | IF center 200MHz<br>100MHz BW                                   |             | +0.006      |                 | dB/MHz |
|                          | Gain <sub>SLOPE2</sub>          | IF center 370MHz<br>200MHz BW                                   |             | +0.008      |                 | dB/MHz |
| Noise Figure             | NF <sub>G11</sub>               | Gain setting = $G_{11}$   |             | 10.0        |                 | dB     |
|                          | NF <sub>G8</sub>                | Gain setting = $G_8$  |             | 10.4        |                 |        |
|                          | NF <sub>G5</sub> <sup>4,5</sup> | Gain setting = $G_5$  |             | 11.1        | 13 <sup>2</sup> |        |
|                          |                                 | Gain setting = $G_5$<br>$F_{IF} = 469MHz$<br>$F_{LO} = 2130MHz$ |             | 11.8        |                 |        |
|                          | NF <sub>G2</sub>                | Gain setting = $G_2$  |             | 11.9        |                 |        |
| Input IP3                | IIP3 <sub>G11</sub>             | Gain setting = $G_{11}$<br>800 kHz tone separation              |             | 24          |                 | dBm    |
|                          | IIP3 <sub>G8</sub>              | Gain setting = $G_8$<br>800 kHz tone separation                 |             | 28          |                 |        |
|                          | IIP3 <sub>G5</sub> <sup>4</sup> | Gain setting = $G_5$<br>800 kHz tone separation                 | 25          | 28          |                 |        |
|                          | IIP3 <sub>G2</sub>              | Gain setting = $G_2$<br>800 kHz tone separation                 |             | 29          |                 |        |
| G3 IIP3 change over temp | IIP3 <sub>G3TempDrift</sub>     | Tcase -40C / +105C referenced to +25C                           |             | -0.8/+1.8   |                 | dB     |

NOTE 1: Items in min/max columns in **bold italics** are Guaranteed by Test.

NOTE 2: Items in min/max columns that are not bold/italics are Guaranteed by Design Characterization.

NOTE 3: JEDEC 3.3V and JEDEC 1.8V logic

NOTE 4: Specification limits over voltage and temperature

NOTE 5: Max limit at Tcase = +105C

**Table 10. IDTF1792 Specification (High Band) Continued (-1-)**

Typical Application Circuit,  $V_{CC} = +3.3V$ ,  $T_C = +25^\circ C$ ,  $F_{RF} = 2600MHz$ ,  $F_{IF} = 199MHz$ ,  $F_{LO} = 2401MHz$ ,  $P_{LO} = 0\text{ dBm}$ ,  $P_{IN} = -10\text{dBm}$  per tone for all gain settings unless otherwise stated,  $STBY = LOW$ . EVkit IF transformer losses are de-embedded unless otherwise noted. Gain Setting =  $G_5$  (~ 5 dB gain).

| Parameter                      | Symbol                           | Conditions   | Minimum | Typical | Maximum | Units |
|--------------------------------|----------------------------------|--|---------|---------|---------|-------|
| Output IP3                     | OIP3 <sub>G11</sub>              | Gain setting = $G_{11}$<br>800 kHz tone separation                                   |         | 34.7    |         | dBm   |
|                                | OIP3 <sub>G8</sub>               | Gain setting = $G_8$<br>800 kHz tone separation                                      |         | 35.4    |         |       |
|                                | OIP3 <sub>G5</sub>               | Gain setting = $G_5$<br>800 kHz tone separation                                      |         | 32.5    |         | dBm   |
|                                |                                  | Gain setting = $G_5$<br>$T_c = +105^\circ C$<br>LO power = -3dBm<br>$V_{cc} = 3.15V$ | 28.4    | 29.3    |         |       |
|                                |                                  | Gain setting = $G_5$<br>$F_{IF} = 469MHz$<br>$F_{LO} = 2130MHz$                      |         | 31.0    |         |       |
|                                | OIP3 <sub>G2</sub>               | Gain setting = $G_2$<br>800 kHz tone separation                                      |         | 30.5    |         |       |
| Input P1dB                     | IP1dB <sub>G11</sub>             | Gain setting = $G_{11}$  |         | 8.3     |         | dBm   |
|                                | IP1dB <sub>G8</sub>              | Gain setting = $G_8$   |         | 10.8    |         |       |
|                                | IP1dB <sub>G5</sub> <sup>4</sup> | Gain setting = $G_5$   | 11.8    | 13.2    |         |       |
|                                |                                  | Gain setting = $G_5$<br>$F_{IF} = 469MHz$<br>$F_{LO} = 2130MHz$                      |         | 13.1    |         |       |
|                                | IP1dB <sub>G2</sub>              | Gain setting = $G_2$   |         | 14.6    |         |       |
| Maximum saturated output power | $P_{sat}$                        | $P_{in}$ up to +20dBm  |         | 17      |         | dBm   |
| LO to IF leakage               | ISO <sub>LI</sub>                |  |         | -40     | -38     | dBm   |
| 2LO to IF leakage              | ISO <sub>LI2</sub>               |  |         | -44     |         | dBm   |

NOTE 1: Items in min/max columns in **bold italics** are Guaranteed by Test.

NOTE 2: Items in min/max columns that are not bold/italics are Guaranteed by Design Characterization.

NOTE 3: JEDEC 3.3V and JEDEC 1.8V logic

NOTE 4: Specification limits over voltage and temperature

NOTE 5: Max limit at  $T_{case} = +105C$

**Table 11. IDTF1792 Specification (High Band) Continued (-2-)**

Typical Application Circuit,  $V_{CC} = +3.3V$ ,  $T_C = +25^\circ C$ ,  $F_{RF} = 2600MHz$ ,  $F_{IF} = 199MHz$ ,  $F_{LO} = 2401MHz$ ,  $P_{LO} = 0\text{ dBm}$ ,  $P_{IN} = -10dBm$  per tone for all gain settings unless otherwise stated, STBY = LOW. EVkit IF transformer losses are de-embedded unless otherwise noted. Gain Setting =  $G_5$  (~ 5 dB gain).

| Parameter         | Symbol      | Conditions   | Minimum | Typical | Maximum | Units |
|-------------------|-------------|--|---------|---------|---------|-------|
| 3LO to IF leakage | $ISO_{LI3}$ |  |         | -68     |         | dBm   |
| 4LO to IF leakage | $ISO_{LI4}$ |  |         | -71     |         | dBm   |
| RF to IF leakage  | $ISO_{RI}$  | RF output power compared to measured IF output power |         | -51     | -30     | dBc   |
| LO to RF leakage  | $ISO_{LR}$  |  |         | -51     |         | dBm   |
| RF Return Loss    | $RL_{RF}$   | Single Ended 50 ohm                                  |         | -17     |         | dB    |

NOTE 1: Items in min/max columns in ***bold italics*** are Guaranteed by Test.

NOTE 2: Items in min/max columns that are not bold/italics are Guaranteed by Design Characterization.

NOTE 3: JEDEC 3.3V and JEDEC 1.8V logic

NOTE 4: Specification limits over voltage and temperature

NOTE 5: Max limit at  $T_{case} = +105C$

## Thermal Characteristics

**Table 12. Package Thermal and Moisture Characteristics**

| Symbol        | Parameter                                   | Value           | Units |
|---------------|---|-----------------|-------|
| $\theta_{JA}$ | Theta JA. Junction to ambient.              | 45 <sup>a</sup> | °C/W  |
| $\theta_{JC}$ | Theta JC. Junction to case.                 | 2.1             | °C/W  |
| -             | Moisture Sensitivity Rating (Per J-STD-020) | MSL 1           | -     |

## Typical Performance Characteristics

### TYPICAL OPERATING CONDITIONS (TOC)

Unless otherwise noted, the following apply to the Typ Ops Graphs

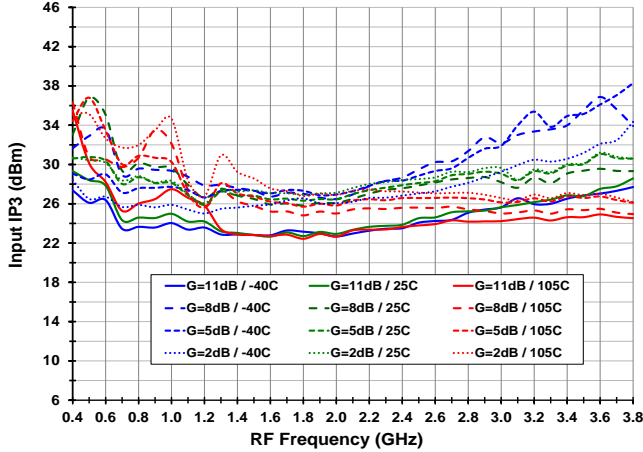
- High Side Injection for RF frequencies below 1.2 GHz
- Low Side Injection for RF frequencies from 1.3 to 2.7 GHz
- 199MHz IF
- 800KHz Tone Spacing
- All measurements fully de-embedded for trace, connector, transformer losses
- Pin = -10dBm for Gain
- Pout = 0 dBm/Tone for IP3
- LO level = 0 dBm, VCC = 3.30 V
- Listed Temperatures are Case Temperature (TC = Case Temperature)
- Where noted, TA or TAMB = Ambient Temperature]

| NxM (dBc, Gset=5 dB, LO=1700 MHz, IF=200 MHz, RFfund=0 dBm at 1900 MHz, RFspur(MHz)=(N*LO(MHz)+IF(MHz))/M ) |    |        |      |      |      |      |      |      |      |      |      |
|---|----|--------|------|------|------|------|------|------|------|------|------|
|   |    | N (LO) |      |      |      |      |      |      |      |      |      |
|   |    | 1      | 2    | 3    | 4    | 5    | 6    | 7    | 8    | 9    | 10   |
| M (RF)  | 1  | 0.0    | 37.7 | 22.0 | 64.3 | 39.4 | 73.3 | 52.4 |      |      |      |
|   | 2  | 54.3   | 69.5 | 53.7 | 64.2 | 50.4 | 57.0 | 61.3 | 71.8 | 62.1 | 88.7 |
|   | 3  | 61.8   | 73.1 | 56.0 | 78.6 | 60   | 79.1 | 69.2 | 83.8 | 82.2 | 96.4 |
|   | 4  | 68.0   | 88.8 | 94.4 | 91.5 | 97.2 | 96.7 | 87.7 | 94.1 | 87.1 | 98.7 |
|   | 5  | >99    | >99  | 81.1 | 95.7 | 94.9 | 97.8 | 94.9 | >99  | 86.6 | 97.3 |
|   | 6  | >99    | >99  | >99  | >99  | >99  | >99  | >99  | >99  | >99  | >99  |
|   | 7  | >99    | >99  | >99  | >99  | >99  | >99  | >99  | >99  | >99  | >99  |
|   | 8  | >99    | >99  | >99  | >99  | >99  | >99  | >99  | >99  | >99  | >99  |
|   | 9  | >99    | >99  | >99  | >99  | >99  | >99  | >99  | >99  | >99  | >99  |
|   | 10 | >99    | >99  | >99  | >99  | >99  | >99  | >99  | >99  | >99  | >99  |

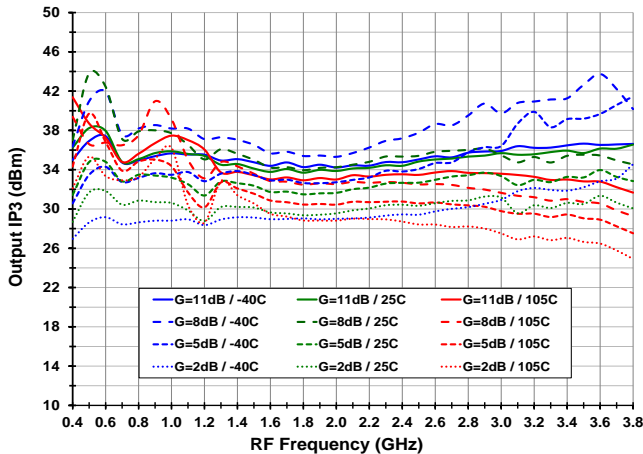
| NxM (dBc, Gset=5 dB, LO=1700 MHz, IF=200 MHz, RFfund=0 dBm at 1500 MHz, RFspur(MHz)=(N*LO(MHz)+IF(MHz))/M ) |    |        |      |      |      |      |      |      |      |      |      |
|---|----|--------|------|------|------|------|------|------|------|------|------|
|   |    | N (LO) |      |      |      |      |      |      |      |      |      |
|   |    | 1      | 2    | 3    | 4    | 5    | 6    | 7    | 8    | 9    | 10   |
| M (RF)  | 1  | 0.0    | 42.1 | 19.0 | 61.0 | 36.5 | 77.2 | 50.1 |      |      |      |
|   | 2  | 49.0   | 72.4 | 57.0 | 60.0 | 53.9 | 57.1 | 63.1 | 68.0 | 62.5 | 85.7 |
|   | 3  | 69.8   | 78.6 | 51.5 | 75.9 | 62.1 | 75.3 | 66.0 | 84.5 | 76.2 | 91.4 |
|   | 4  | 72.9   | 86.3 | 98.3 | 91.1 | 97.5 | >99  | 88.2 | 95.8 | 93.2 | >99  |
|   | 5  | >99    | >99  | 85.2 | 96.9 | 86.7 | >99  | 93.2 | 98.2 | 88.6 | 98.3 |
|   | 6  | >99    | >99  | >99  | >99  | >99  | >99  | >99  | >99  | >99  | >99  |
|   | 7  | >99    | >99  | >99  | >99  | >99  | >99  | >99  | >99  | >99  | >99  |
|   | 8  | >99    | >99  | >99  | >99  | >99  | >99  | >99  | >99  | >99  | >99  |
|   | 9  | >99    | >99  | >99  | >99  | >99  | >99  | >99  | >99  | >99  | >99  |
|   | 10 | >99    | >99  | >99  | >99  | >99  | >99  | >99  | >99  | >99  | >99  |

**TOCs (-1-) Fixed IF = 199 MHz – IIP3, OIP3, and Gain**

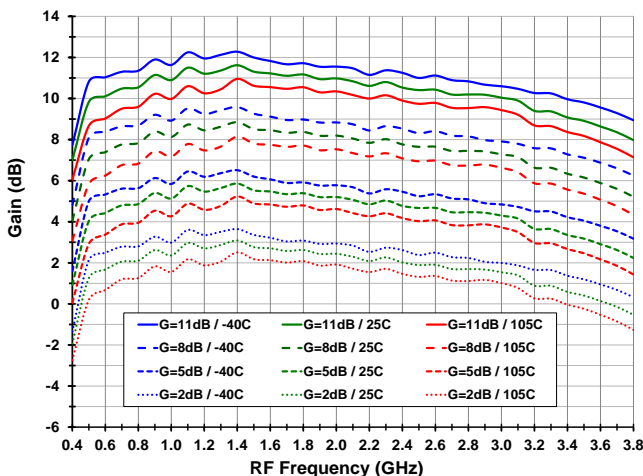
**Figure 3. IIP3 vs. Temperature and Gain Setting**



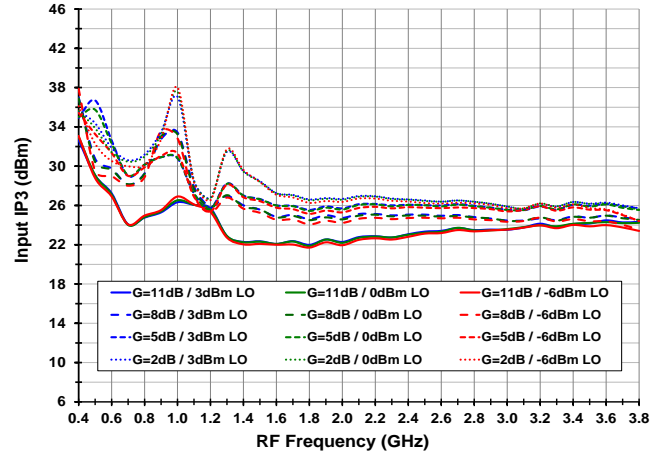
**Figure 4. OIP3 vs. Temperature and Gain Setting**



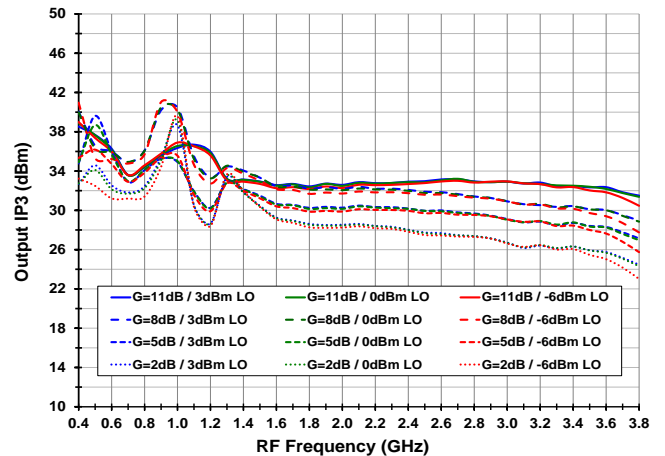
**Figure 5. Gain vs. Temperature and Gain Setting**



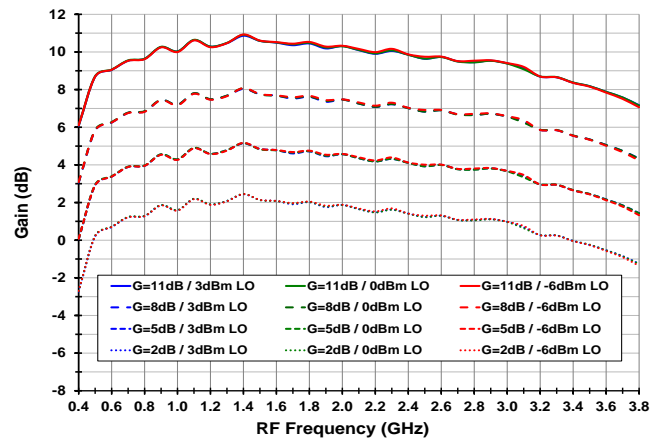
**Figure 6. IIP3 vs. LO Power and Gain Setting (Vcc = 3.15, Tcase = 105C)**



**Figure 7. OIP3 vs. LO Power and Gain Setting (Vcc = 3.15, Tcase = 105C)**

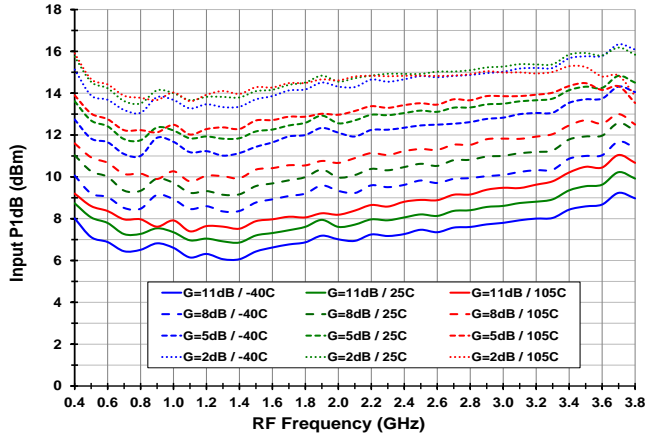


**Figure 8. Gain vs. LO Power and Gain Setting (Vcc = 3.15, Tcase = 105C)**

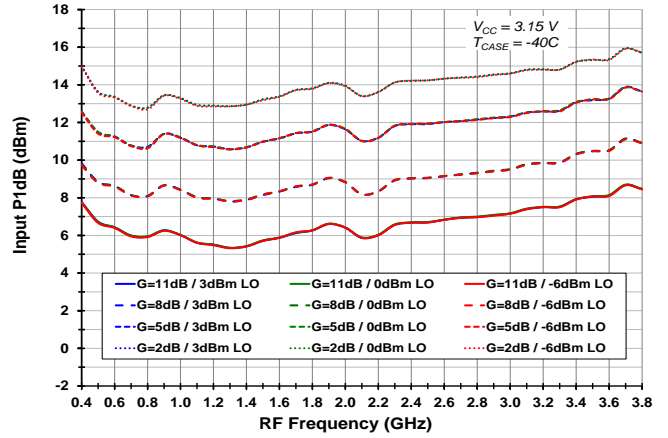


**TOCs (-2-) Fixed IF = 199 MHz – P1dB**

**Figure 9. Input P1dB vs. Temperature and Gain Setting**



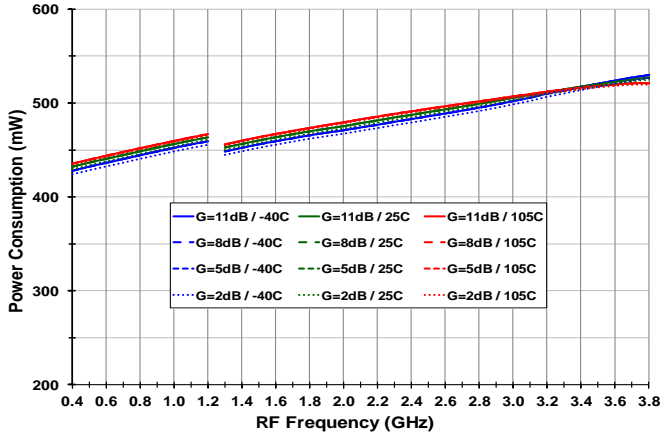
**Figure 10. Input P1dB vs. LO Level and Gain Setting (Vcc = 3.15, Tcase = -40C)**



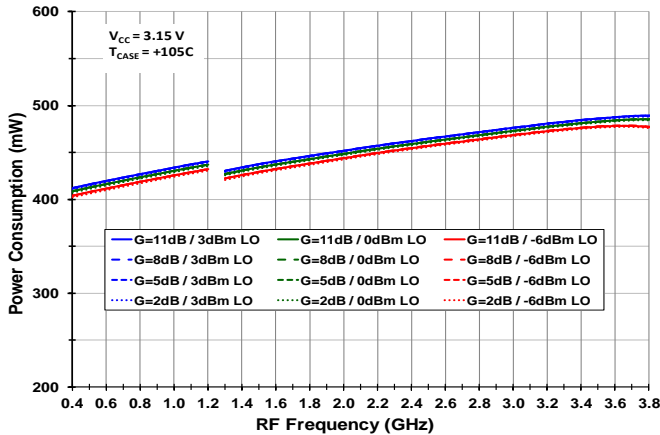


**TOCs (-3-) Fixed IF=199 MHz – Power Consumption, LO to IF Leakage, and RF to IF**

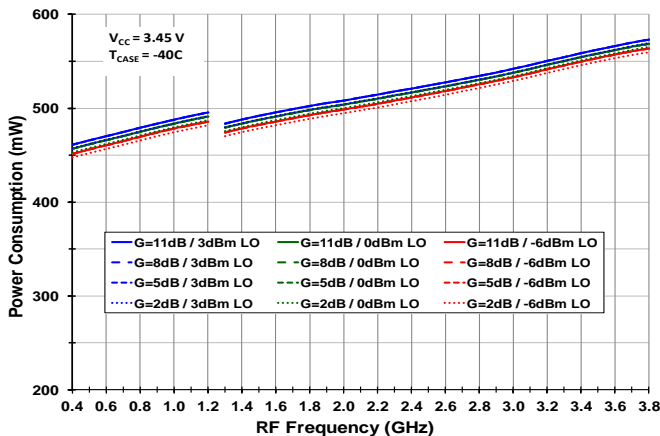
**Figure 11. Power Consumption vs. Temperature and Gain Setting**



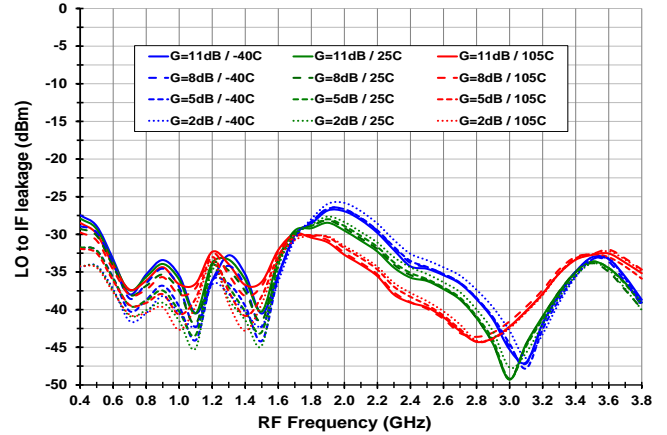
**Figure 12. Power Consumption vs. Temperature and Gain Setting (V<sub>CC</sub> = 3.15, T<sub>case</sub> = 105C)**



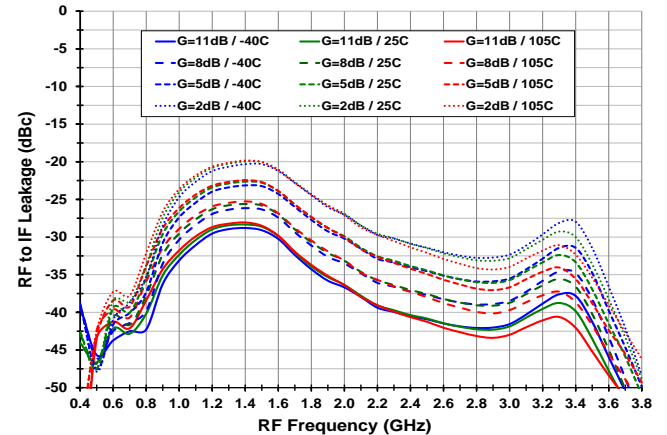
**Figure 13. Power Consumption vs. Temperature and Gain Setting (V<sub>CC</sub> = 3.45, T<sub>case</sub> = -40C)**



**Figure 14. LO to IF Leakage vs. Temperature and Gain Setting**

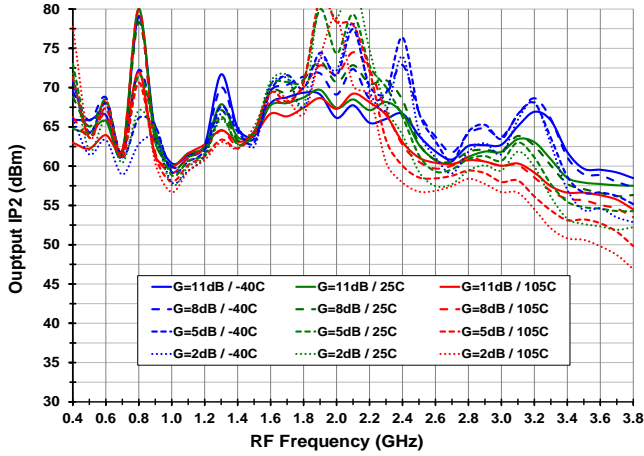


**Figure 15. RF to IF Leakage vs. Temperature and Gain Setting**

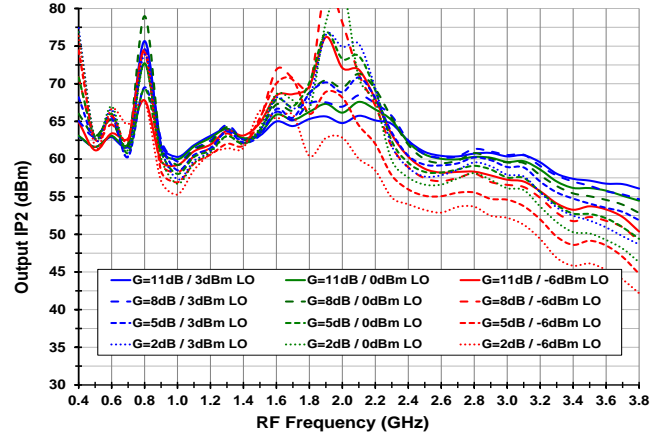


**TOCs (-4-) Fixed IF=199 MHz – Output IP2, Noise Figure**

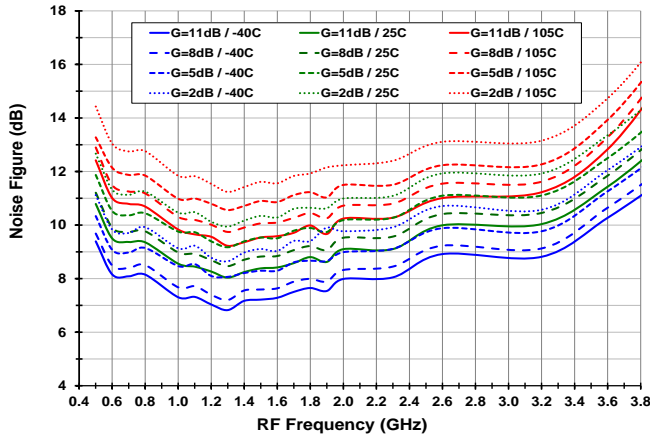
**Figure 16. Output IP2 vs. Temperature and Gain Setting**



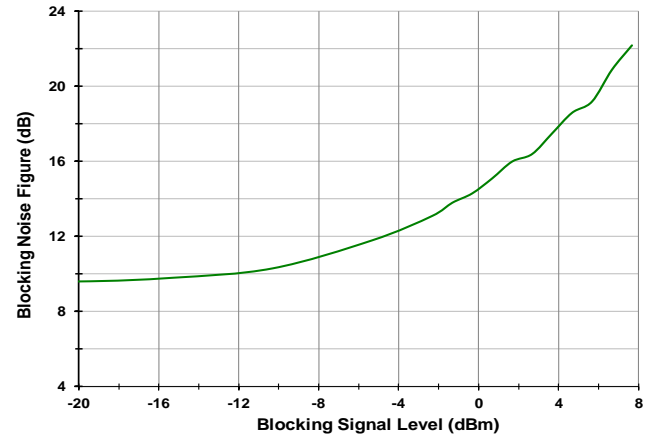
**Figure 18. Output IP2 vs. Temperature and Gain Setting (Vcc = 3.15, Tcase = 105C)**



**Figure 17. Noise Figure vs. Temperature and Gain Setting**

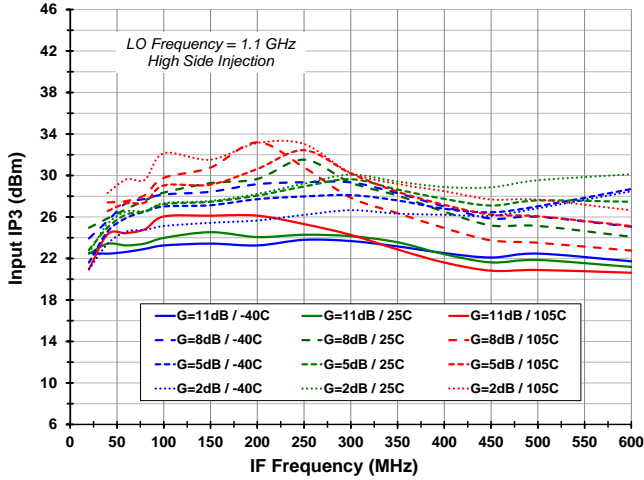


**Figure 19. Blocking Noise Figure (Max Gain, LO=1700MHz, RF=1899MHz, Blocker=1999MHz, 25C ambient)**

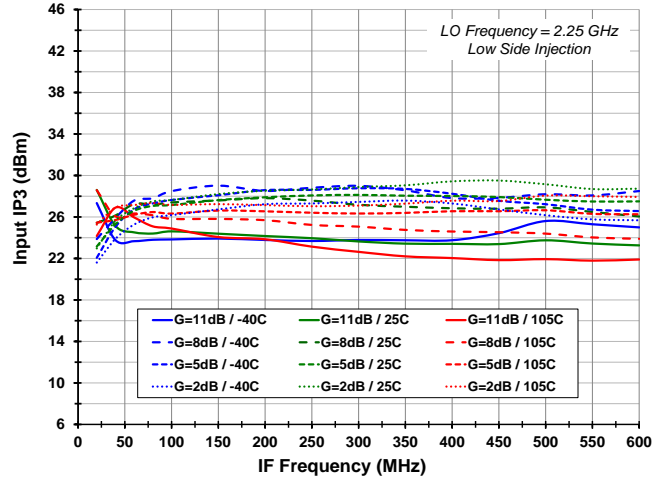


**TOCs (-5-) Fixed LO = 1.1 GHz, 1.7 GHz, 2.25 GHz, 3.13 GHz – Input IP3**

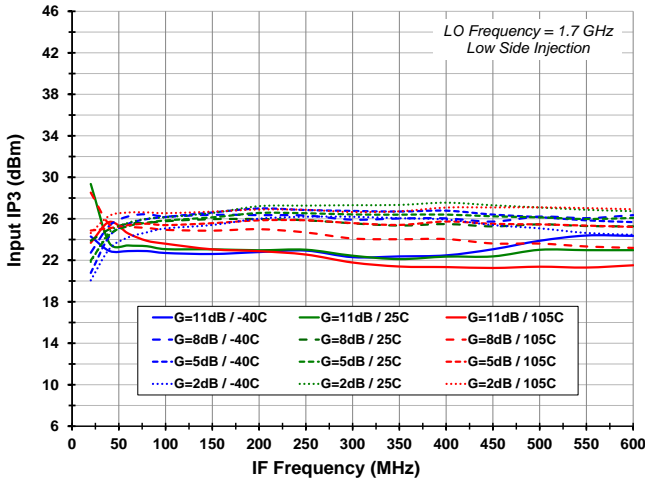
**Figure 20. Input IP3 vs. Temperature and Gain Setting (LO=1.1 GHz)**



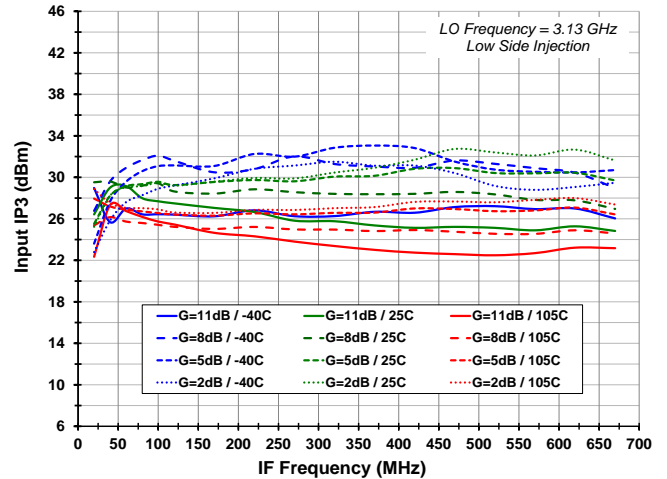
**Figure 22. Input IP3 vs. Temperature and Gain Setting (LO=2.25 GHz)**



**Figure 21. Input IP3 vs. Temperature and Gain Setting (LO=1.7 GHz)**

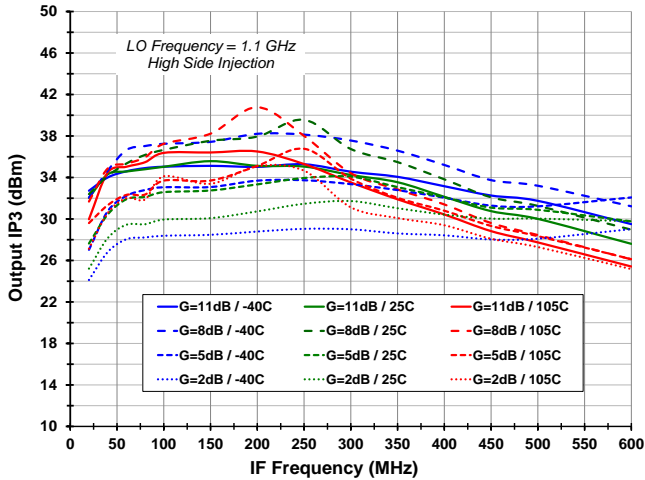


**Figure 23. Input IP3 vs. Temperature and Gain Setting (LO=3.13 GHz)**

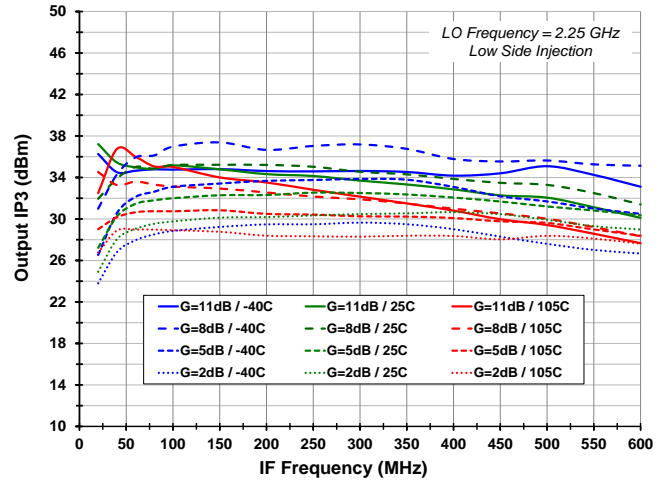


**TOCs (-6-) Fixed LO = 1.1 GHz, 1.7 GHz, 2.25 GHz, 3.13 GHz – Output IP3**

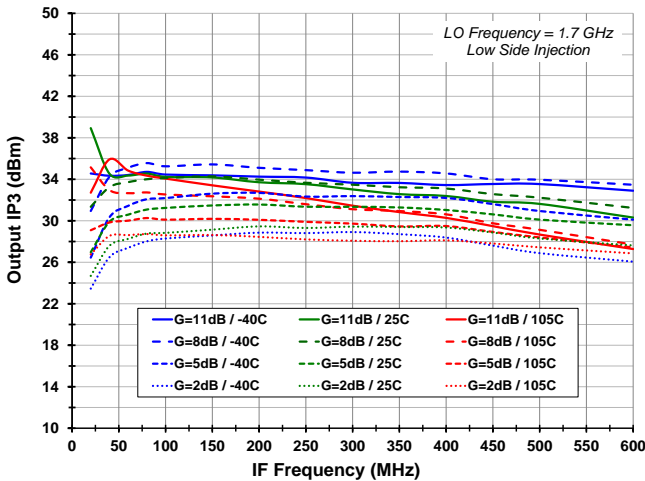
**Figure 24. Output IP3 vs. Temperature and Gain Setting (LO=1.1 GHz)**



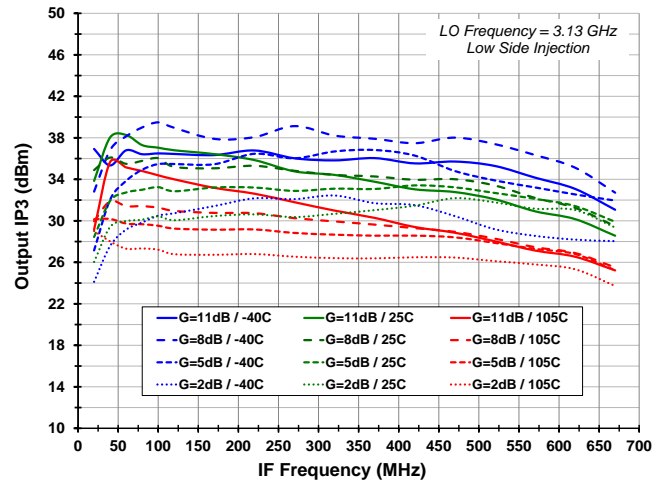
**Figure 26. Output IP3 vs. Temperature and Gain Setting (LO=2.25 GHz)**



**Figure 25. Output IP3 vs. Temperature and Gain Setting (LO=1.7 GHz)**

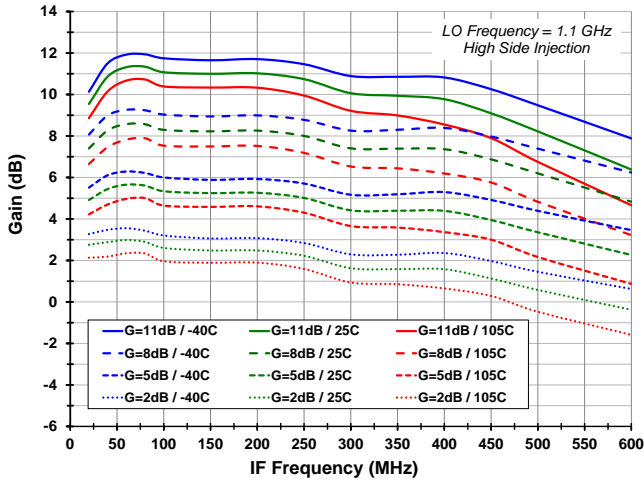


**Figure 27. Output IP3 vs. Temperature and Gain Setting (LO=3.13 GHz)**

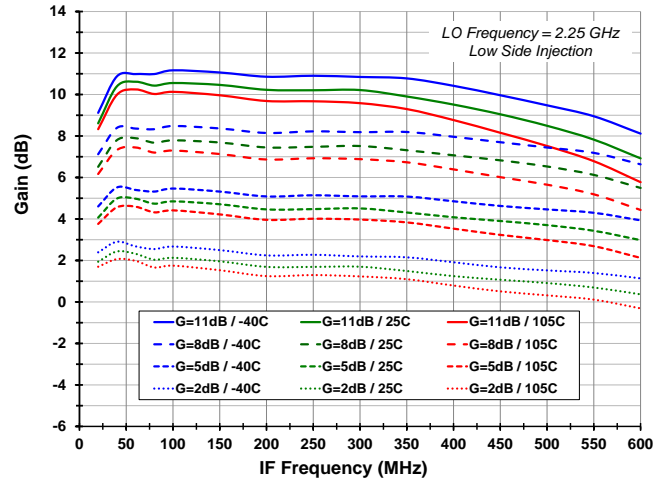


**TOCs (-7-) Fixed LO = 1.1 GHz, 1.7 GHz, 2.25 GHz, 3.13 GHz – Gain**

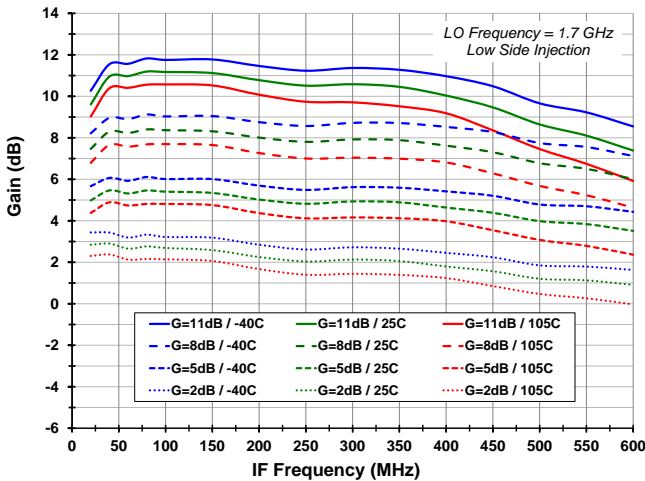
**Figure 28. Gain vs. Temperature and Gain Setting (LO=1.1 GHz)**



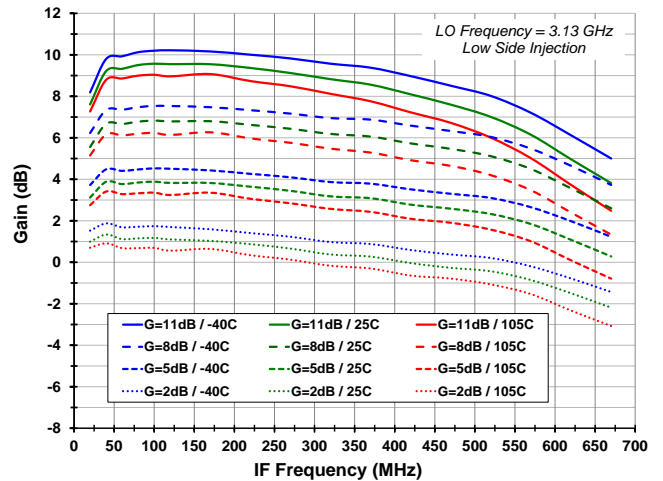
**Figure 30. Gain vs. Temperature and Gain Setting (LO=2.25 GHz)**



**Figure 29. Gain vs. Temperature and Gain Setting (LO=1.7 GHz)**

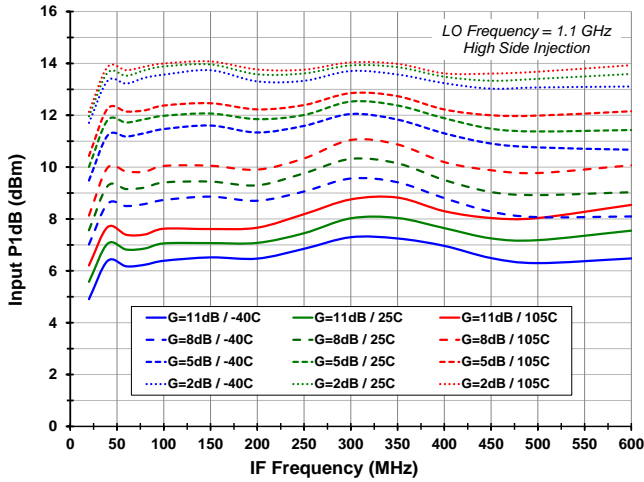


**Figure 31. Gain vs. Temperature and Gain Setting (LO=3.13 GHz)**

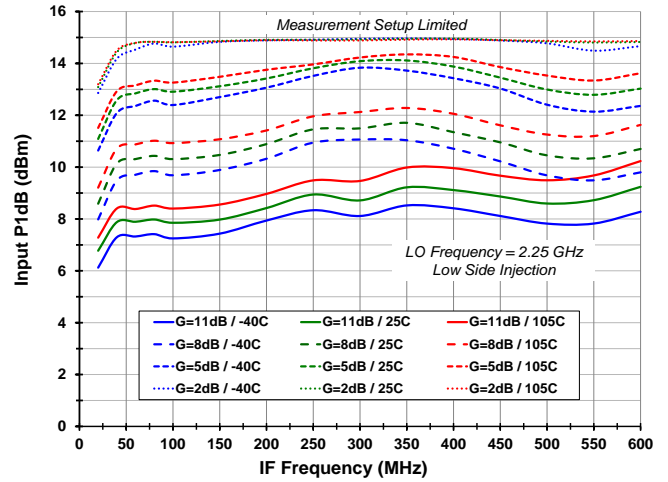


**TOCs (-8-) Fixed LO = 1.1 GHz, 1.7 GHz, 2.25 GHz, 3.13 GHz – Input P1dB**

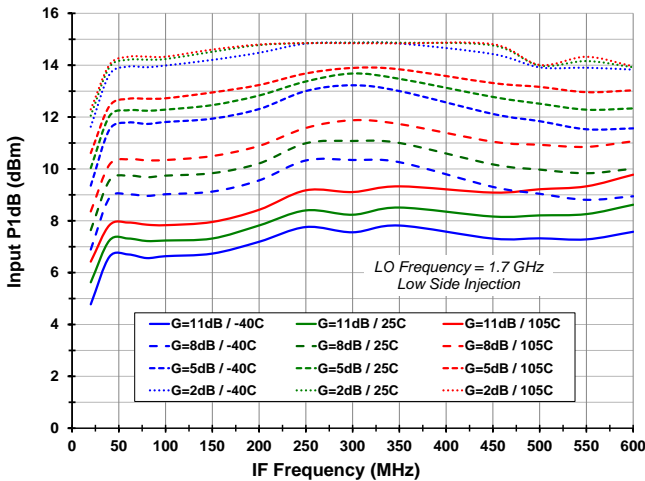
**Figure 32. Input P1dB vs. Temperature and Gain Setting (LO=1.1 GHz)**



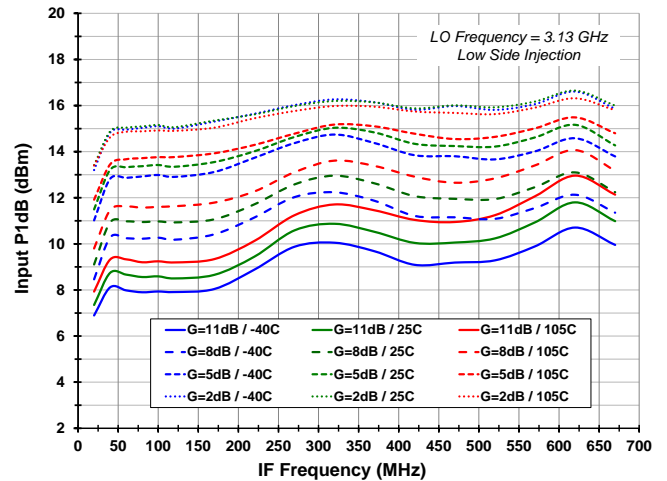
**Figure 34. Input P1dB vs. Temperature and Gain Setting (LO=2.25 GHz)**



**Figure 33. Input P1dB vs. Temperature and Gain Setting (LO=1.7 GHz)**

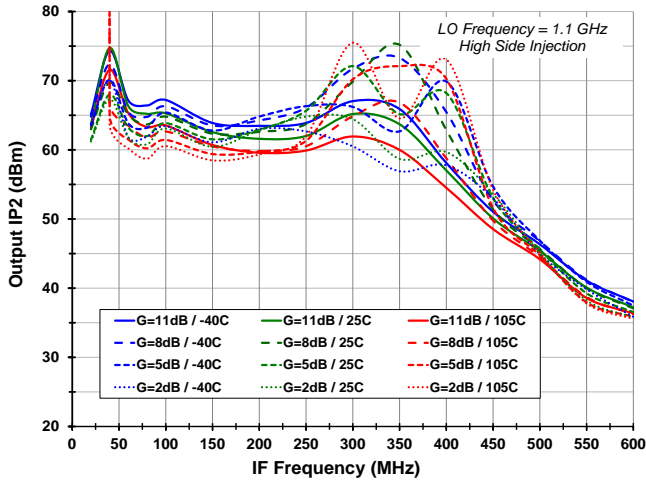


**Figure 35. Input P1dB vs. Temperature and Gain Setting (LO=3.13 GHz)**

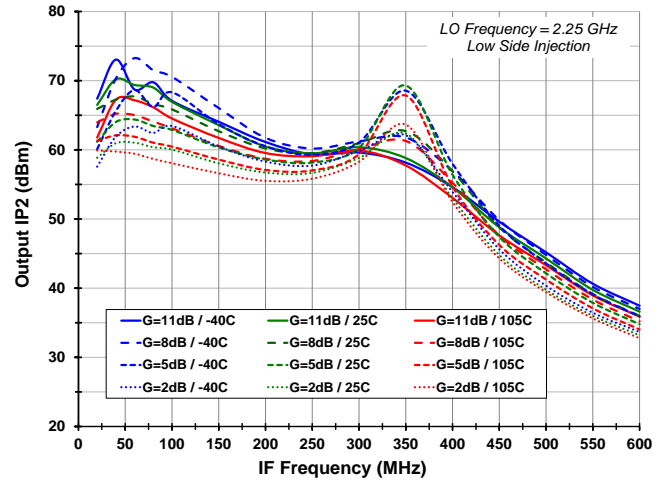


**TOCs (-9-) Fixed LO=1.1GHz, 1.7GHz, 2.25GHz, 3.13GHz – Output IP2**

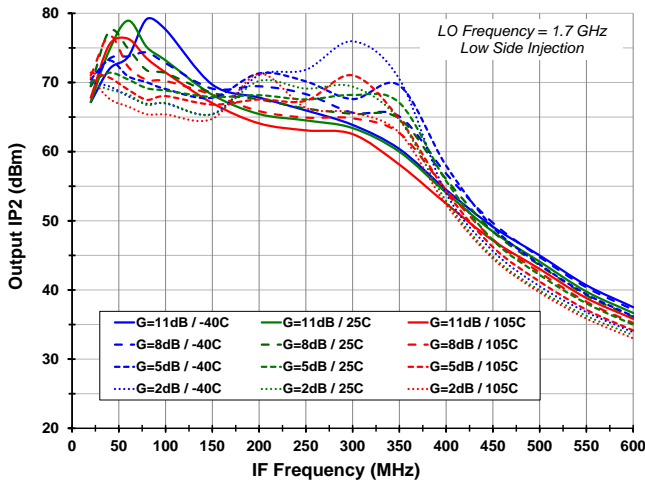
**Figure 36. Output IP2 vs. Temperature and Gain Setting (LO=1.1 GHz)**



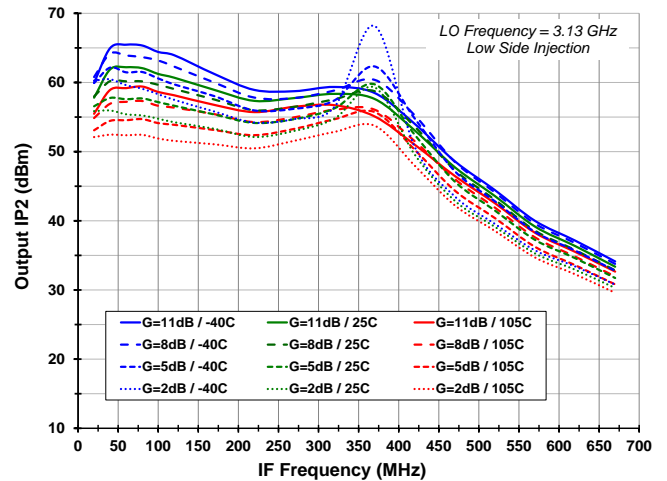
**Figure 38. Output IP2 vs. Temperature and Gain Setting (LO=2.25 GHz)**



**Figure 37. Output IP2 vs. Temperature and Gain Setting (LO=1.7 GHz)**

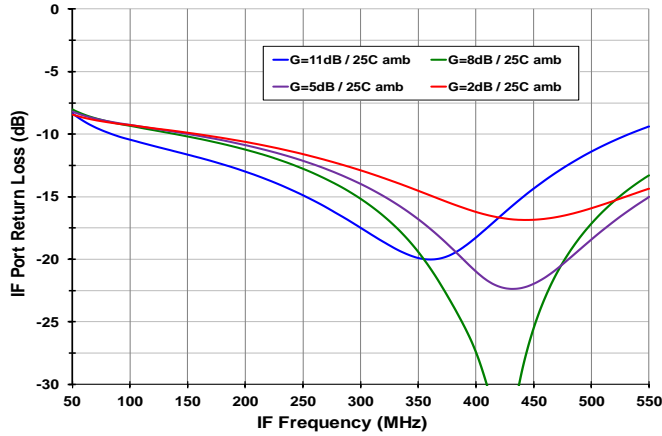


**Figure 39. Output IP2 vs. Temperature and Gain Setting (LO=3.13 GHz)**

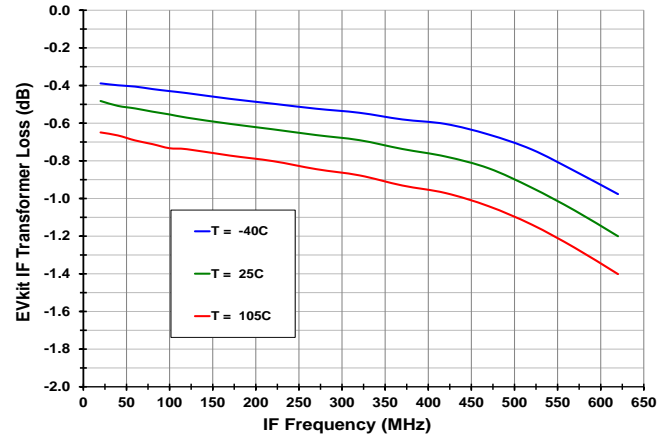


# TOCs (-10-) Return Losses, Evaluation Kit Losses, STBY Settling Time

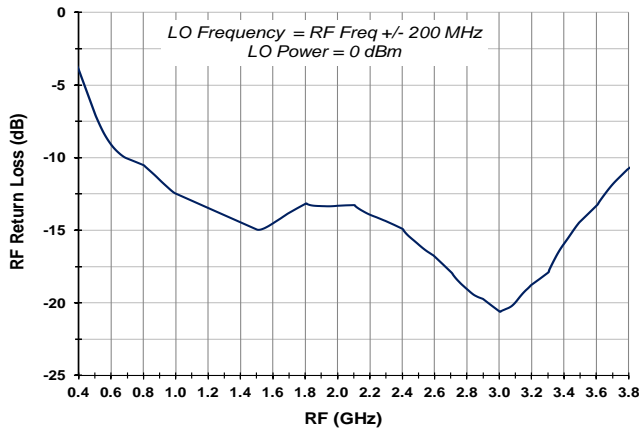
**Figure 40. IF Port Return Loss vs. Gain Setting**



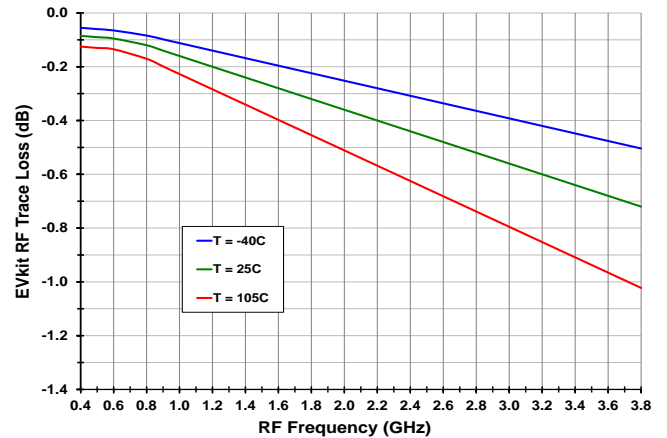
**Figure 43. Evaluation Kit IF Transformer Loss vs. Temperature**



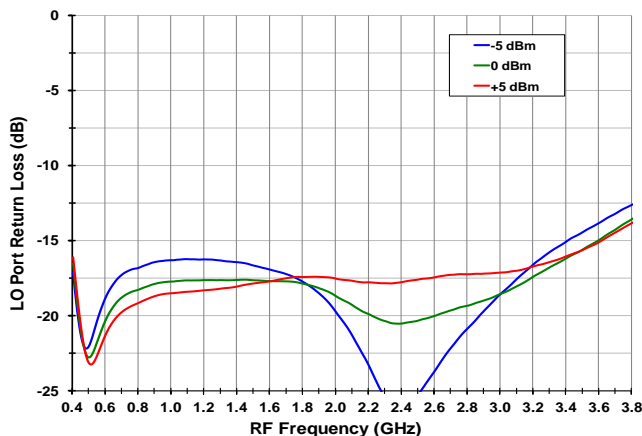
**Figure 41. RF Port Return Loss vs. LO Frequency**



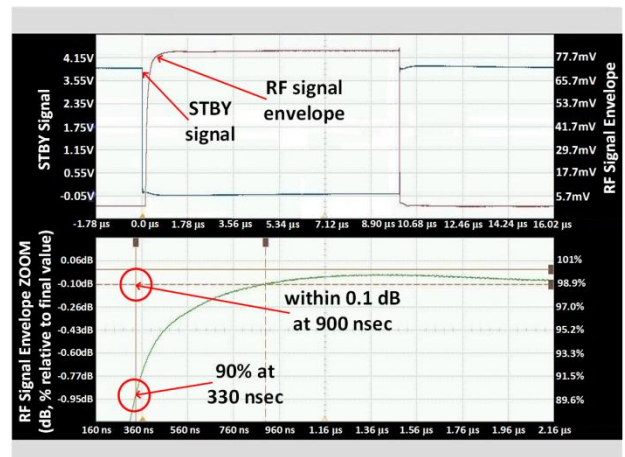
**Figure 44. Evaluation Kit RF Trace Loss vs. Temperature**



**Figure 42. LO Port Return Loss vs. LO Power Level**



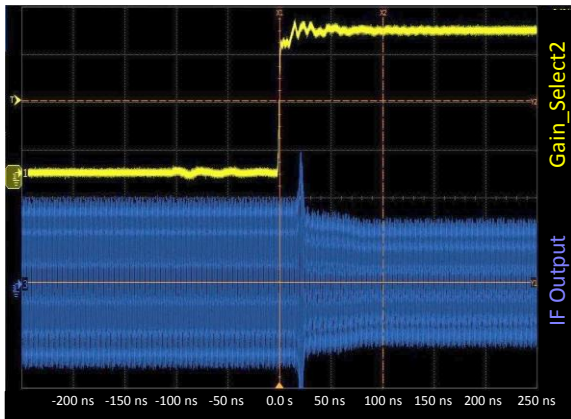
**Figure 45. STBY Settling Time**



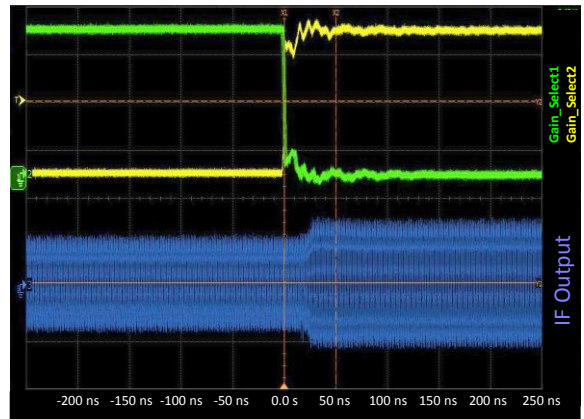


## TOCs (-11-) Gain Settling Time

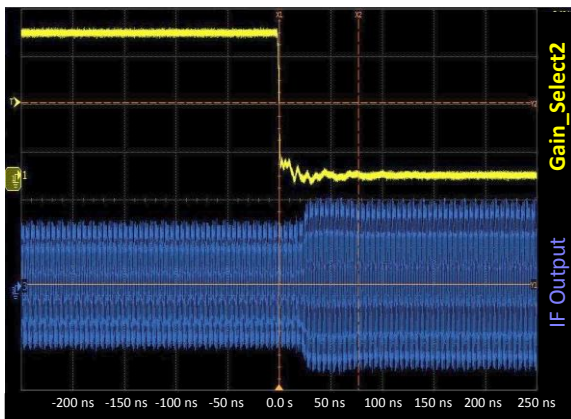
**Figure 46. Gain Settling Time for 11 dB to 8 dB Gain Setting**



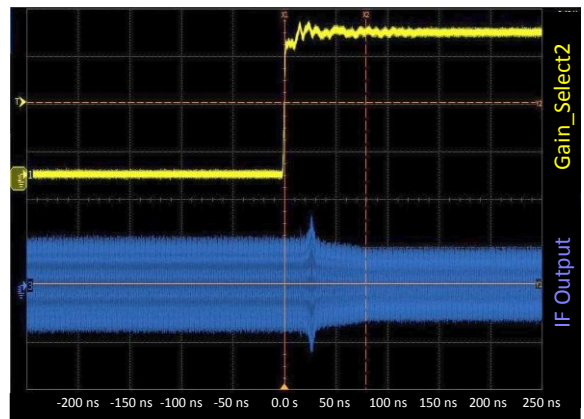
**Figure 49. Gain Settling Time for 5 dB to 8 dB Gain Setting**



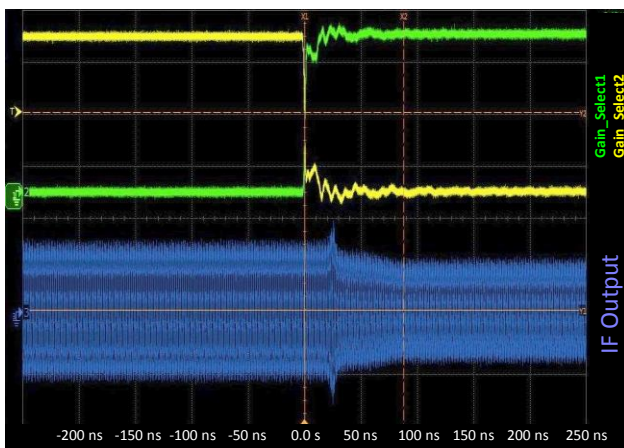
**Figure 47. Gain Settling Time for 8 dB to 11 dB Gain Setting**



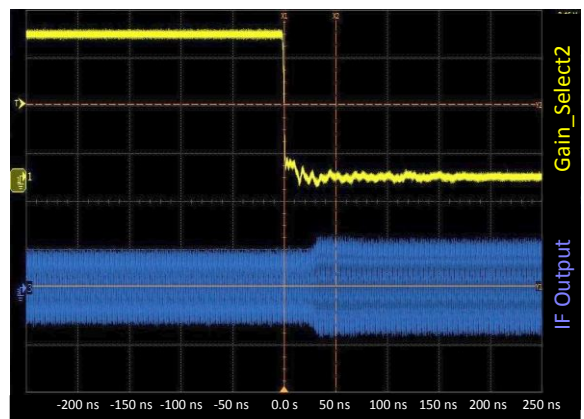
**Figure 50. Gain Settling Time for 5 dB to 2 dB Gain Setting**



**Figure 48. Gain Settling Time for 8 dB to 5 dB Gain Setting**

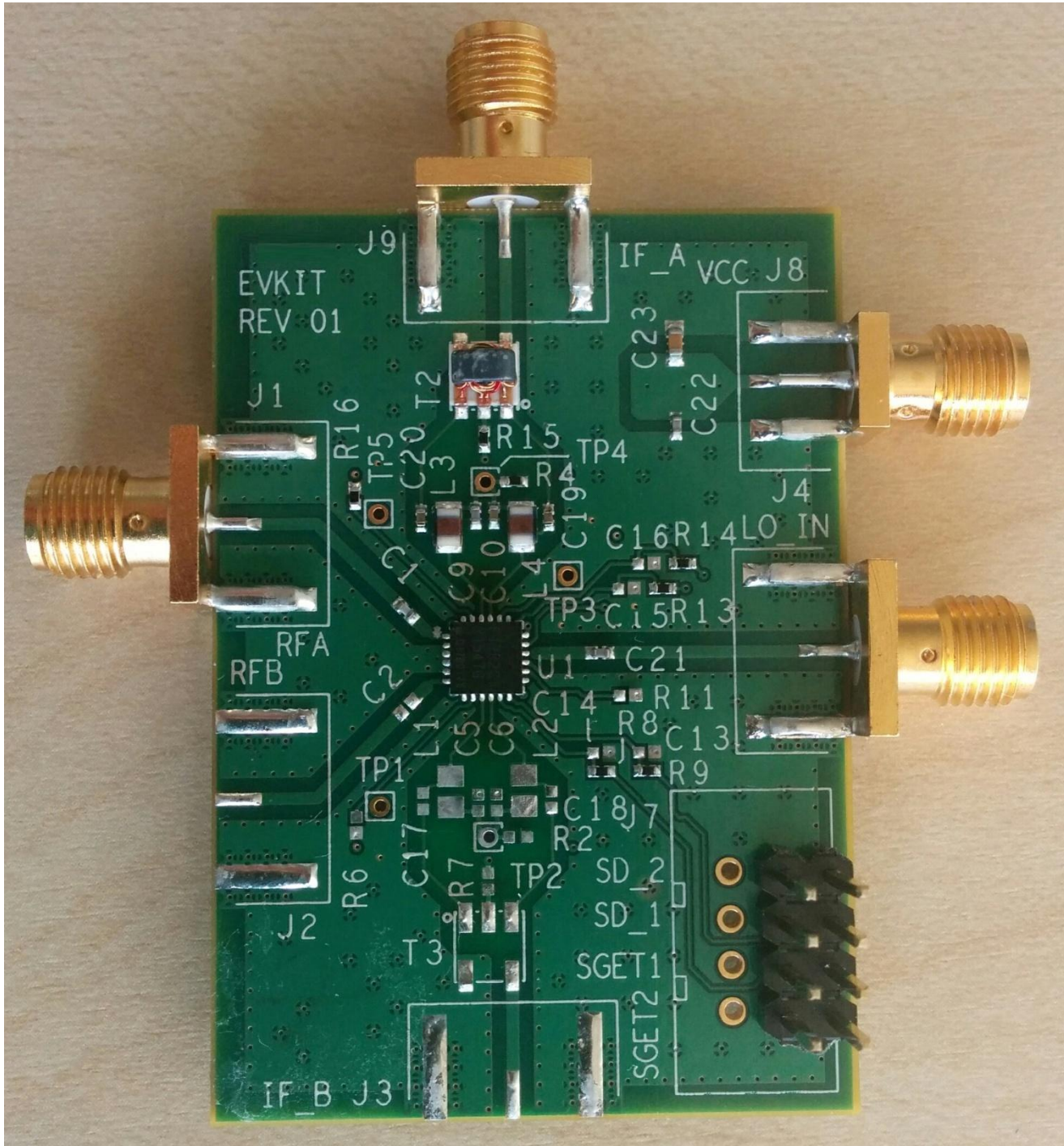


**Figure 51. Gain Settling Time for 2 dB to 5 dB Gain Setting**

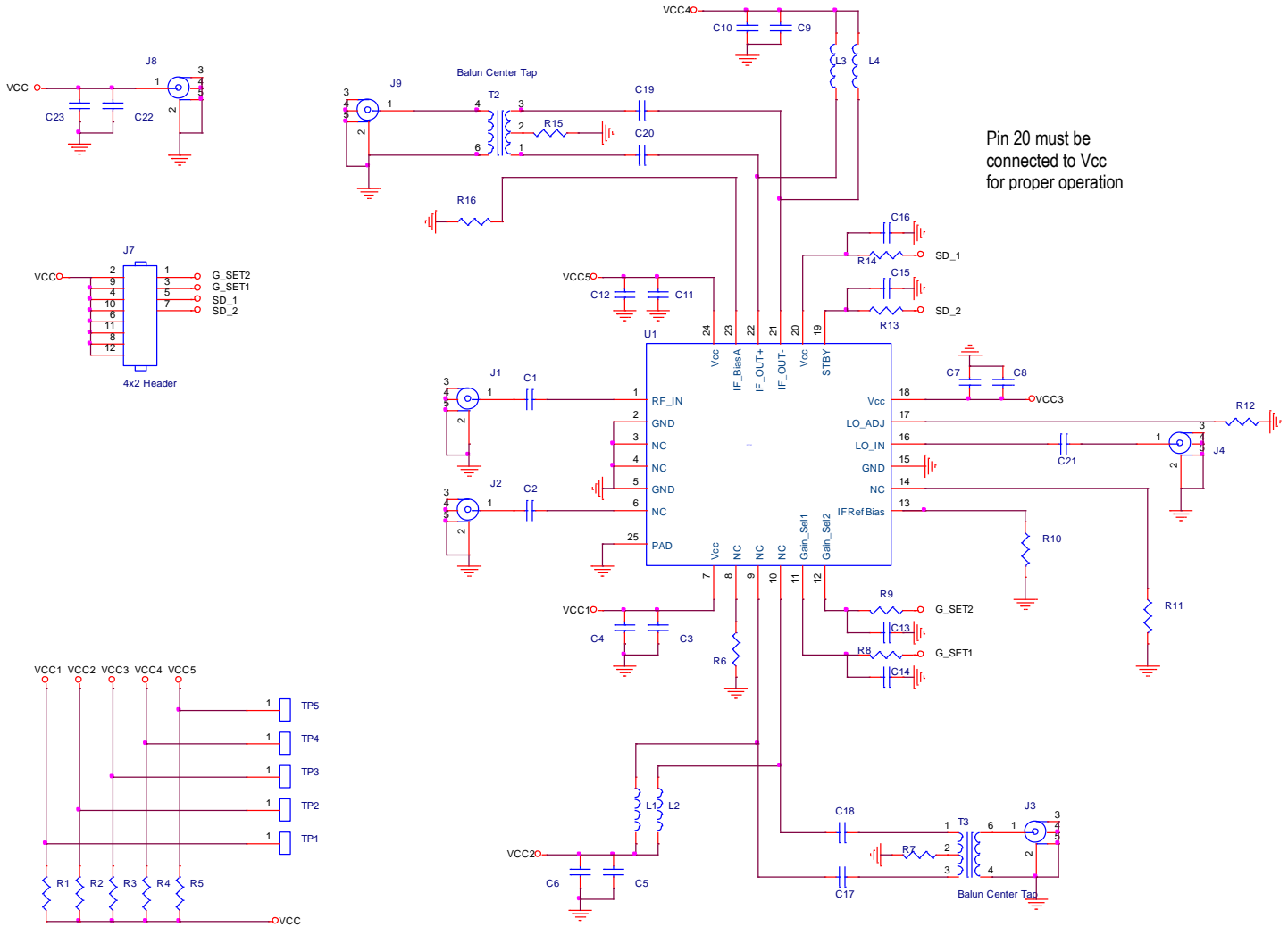


## Applications Information

### EvKit Picture



EvKit / Applications Circuit



## EvKit BOM

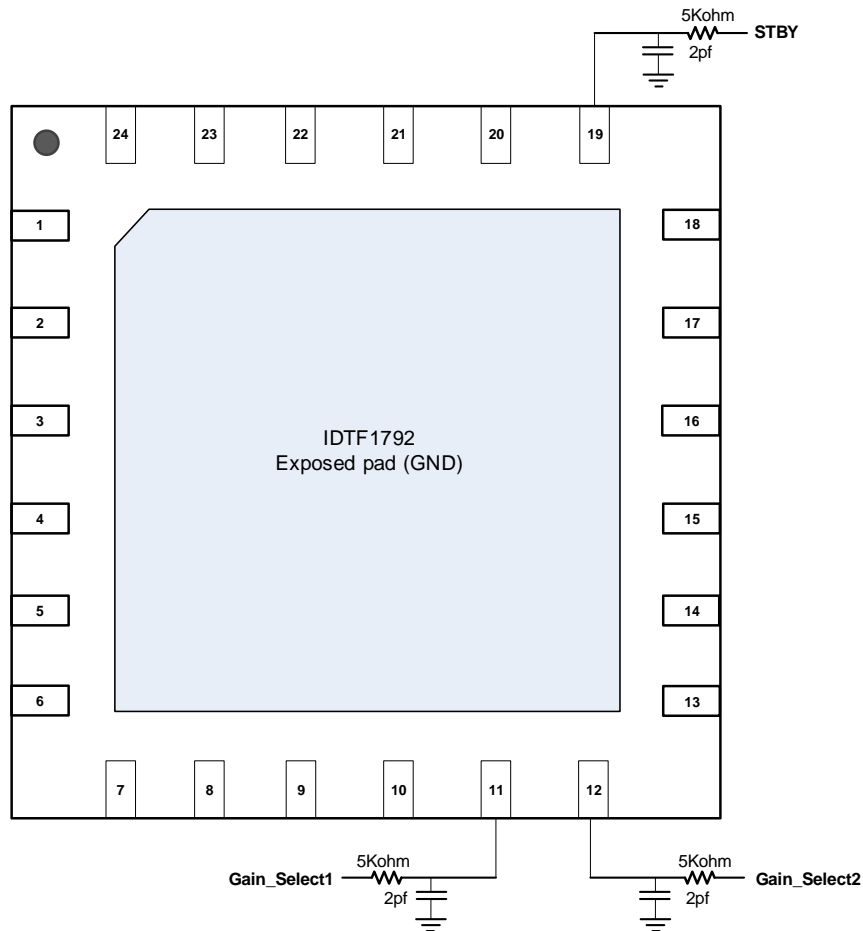
| Part Reference                        | QTY | DESCRIPTION  | Mfr. Part #        | Mfr.            |
|---------------------------------------|-----|--|--------------------|-----------------|
| C3, C7, C9, C11, C22                  | 6   | 1000pF $\pm$ 5%, 50V, C0G Ceramic Capacitor (0402)             | GRM1555C1H102J     | Murata          |
| C4, C8, C10, C12, C19, C20, C23       | 10  | 10,000pF $\pm$ 10%, 50V, X7R Ceramic Capacitor (0603)          | GRM188R71H103KA01D | Murata          |
| C21                                   | 1   | 1000pF $\pm$ 5%, 50V, C0G Ceramic Capacitor (0402)             | GRM1555C1H102J     | Murata          |
| C1,                                   | 2   | 39pF $\pm$ 5%. 5V, C0G Ceramic Capacitor (0402)                | GRM1555C1H390J     | Murata          |
| R1, R3-R5, R8, R9, R12, R13, R14, R15 | 13  | 0 Ohm, 1/10W, Resistor (0402)                                  | ERJ-2GE0R00X       | Panasonic       |
| R16                                   | 2   | 390 Ohm $\pm$ 1%, 1/10W, Resistor (0402)                       | ERJ-2RKF3900X      | Panasonic       |
| R10                                   | 1   | 1.74 kOhm $\pm$ 1%, 1/10W, Resistor (0402)                     | ERJ-2RKF1741X      | Panasonic       |
| L3, L4                                | 4   | 390nH $\pm$ 5%, 0.29 A, Ceramic Chip Inductor (0805)           | 0805CS-391XJL      | Coilcraft       |
| T2                                    | 2   | 4:1 Center Tap Balun   | TC4-6TG2+          | Mini-Circuits   |
| J7                                    | 1   | CONN HEADER VERT DBL 4POS GOLD                                 | 67997-108HLF       | FCI             |
| J1, J4, J9                            | 3   | Edge Launch SMA Connector (Big)                                | 142-0701-851       | Emerson Johnson |
| J8                                    | 1   | Edge Launch SMA Connector (Small)                              | 142-0711-821       | Emerson Johnson |
| U1                                    | 1   | RF Dual Wideband Gain-Settable Downconverting Mixer 4x4 TQFN24 | F1192NLGI          | IDT             |
|                                       | 1   | Printed Circuit Board  | F1192 EVKIT REV 01 | IDT             |

## POWER SUPPLIES

A common VCC power supply should be used for all pins requiring DC power. All supply pins should be bypassed with external capacitors to minimize noise and fast transients. Supply noise can degrade noise figure and fast transients can trigger ESD clamps and cause them to fail. Supply voltage change or transients should have a slew rate smaller than  $1V/20\mu S$ . In addition, all control pins should remain at 0V (+/-0.3V) while the supply voltage ramps or while it returns to zero.

## CONTROL PIN INTERFACE

If control signal integrity is a concern and clean signals cannot be guaranteed due to overshoot, undershoot, ringing, etc., provisions for an R-C circuit at the input of each control pin is recommended. This applies to pins 11, 12, and 19 as shown below.



## GAIN SELECT

F1192 provides a gain select feature requiring 2 pins for logic control. The following table summarizes the required pin logic to achieve the desired gain setting. Internal pull down resistors are included requiring no control to set both channels to maximum gain.

| Desired Power Gain (dB) | Gain Select1 (Pin 11) # | Gain Select2 (Pin 12) |
|-------------------------|-------------------------|-----------------------|
| 11                      | 0                       | 0                     |
| 8                       | 0                       | 1                     |
| 5                       | 1                       | 0                     |
| 2                       | 1                       | 1                     |

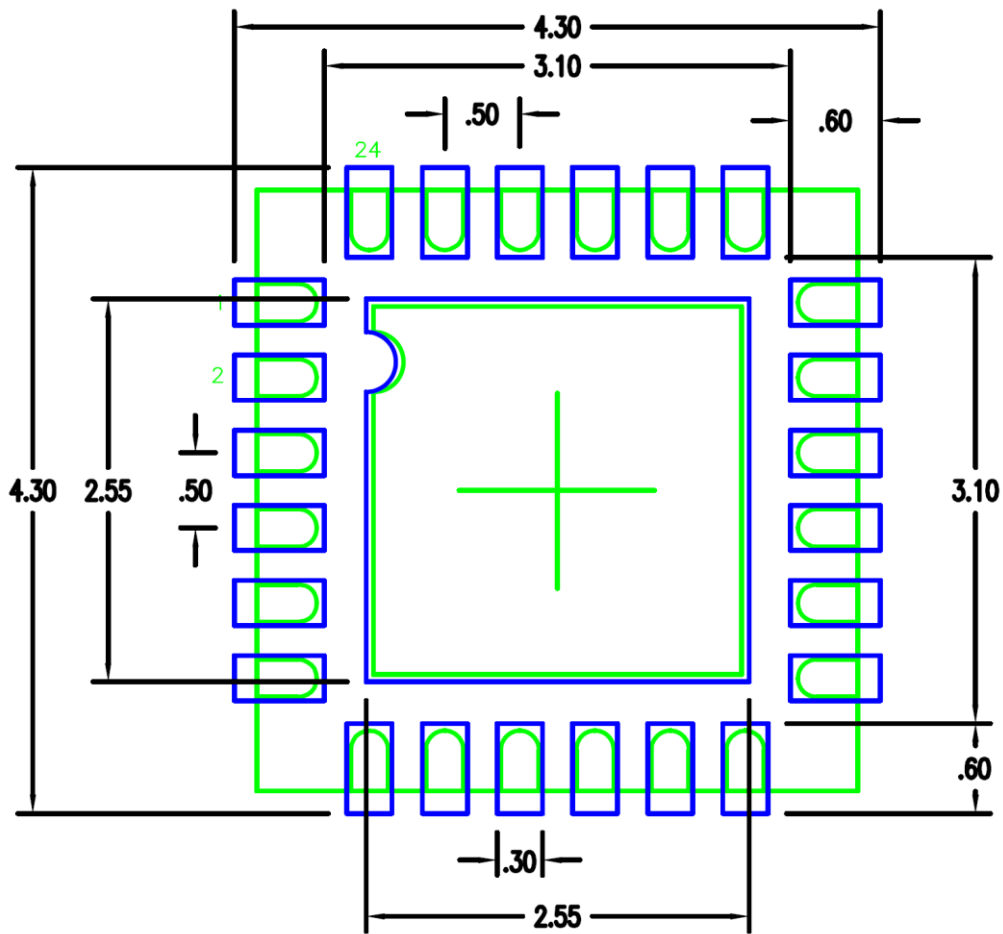
## DEFAULT START-UP

Upon start-up, the device gain will be whatever the gain select pins are set for as defined in the table above.



## Recommended Land Pattern

Figure 53. Recommended Land Pattern



2.45 mm SQ EPAD

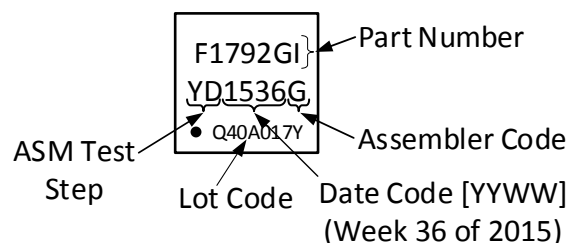
NOTES:

1. ALL DIMENSION ARE IN mm. ANGLES IN DEGREES.
2. TOP DOWN VIEW. AS VIEWED ON PCB.
3. COMPONENT OUTLINE SHOW FOR REFERENCE IN GREEN.
4. LAND PATTERN IN BLUE. NSMD PATTERN ASSUMED.
5. LAND PATTERN RECOMMENDATION PER IPC-7351B GENERIC REQUIREMENT FOR SURFACE MOUNT DESIGN AND LAND PATTERN.

## Ordering Information

| Orderable Part Number | Package            | MSL Rating | Shipping Packaging | Temperature   |
|-----------------------|--------------------|------------|--------------------|---------------|
| F1792NLGI             | 4 x 4 x 0.9 mm-QFN | MSL1       | Tray               | -40° to +85°C |
| F1792NLGI8            | 4 x 4 x 0.9 mm-QFN | MSL1       | Tape and Reel      | -40° to +85°C |

## Marking Diagram



## Revision History

| Revision Date | Description of Change                         |
|---------------|---|
| April 5, 2016 | First release (Rev O) of the F1792 datasheet. |



**Corporate Headquarters**  
 6024 Silver Creek Valley Road  
 San Jose, CA 95138  
[www.IDT.com](http://www.IDT.com)

**Sales**  
 1-800-345-7015 or 408-284-8200  
 Fax: 408-284-2775  
[www.IDT.com/go/sales](http://www.IDT.com/go/sales)

**Tech Support**  
[www.IDT.com/go/support](http://www.IDT.com/go/support)

DISCLAIMER Integrated Device Technology, Inc. (IDT) reserves the right to modify the products and/or specifications described herein at any time, without notice, at IDT's sole discretion. Performance specifications and operating parameters of the described products are determined in an independent state and are not guaranteed to perform the same way when installed in customer products. The information contained herein is provided without representation or warranty of any kind, whether express or implied, including, but not limited to, the suitability of IDT's products for any particular purpose, an implied warranty of merchantability, or non-infringement of the intellectual property rights of others. This document is presented only as a guide and does not convey any license under intellectual property rights of IDT or any third parties.

IDT's products are not intended for use in applications involving extreme environmental conditions or in life support systems or similar devices where the failure or malfunction of an IDT product can be reasonably expected to significantly affect the health or safety of users. Anyone using an IDT product in such a manner does so at their own risk, absent an express, written agreement by IDT.

Integrated Device Technology, IDT and the IDT logo are trademarks or registered trademarks of IDT and its subsidiaries in the United States and other countries. Other trademarks used herein are the property of IDT or their respective third party owners.

For datasheet type definitions and a glossary of common terms, visit [www.idt.com/go/glossary](http://www.idt.com/go/glossary).