

ISL21440

Micropower Voltage Reference with Comparator

FN6532
Rev. 6.00
Mar 12, 2018

The [ISL21440](#) is a micropower, FGA reference, and comparator on a single chip. Drawing less than 6.5µA supply current across the full operating temperature range, the ISL21440 operates from a single 2V to 11V supply and can also be used with split bipolar supplies.

The ISL21440's on-board reference provides a 1.182V ±0.5% output. It features programmable hysteresis and TTL/CMOS compatible outputs that sink and source current. Low bias currents permit high value divider resistors for typical circuit current drains of <2.5µA.

The low supply current makes the ISL21440 ideal for battery powered devices in battery level or low voltage monitor circuits.

The ISL21440 is a pin-compatible, performance upgrade of the LTC1440, LTC1540, MAX921, and MAX931.

Related Literature

For a full list of related documents, visit our website

- [ISL21440](#) product page

Features

- 6.5µA supply current across the full temperature range
- Wide supply range 2V to 11V
- Precision 1.182V ±0.5% voltage reference
- Comparator with user programmable hysteresis
- Temperature range -40°C to +125°C
- 8 Ld MSOP and 8 Ld TDFN packages
- Pin compatible upgrade to MAX921 and LTC1440

Applications

- Low battery detector
- Low voltage reset
- Overvoltage monitor
- Window comparator

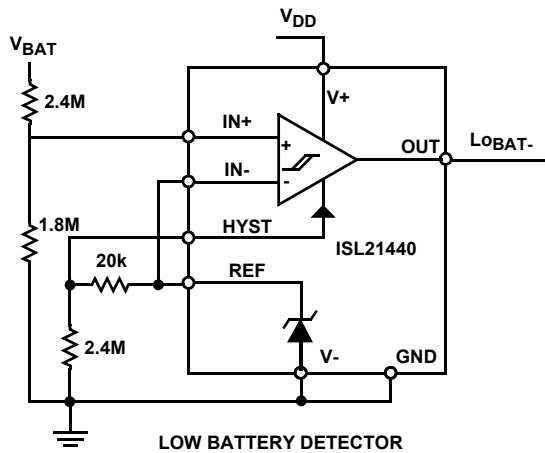

FIGURE 1. TYPICAL APPLICATION

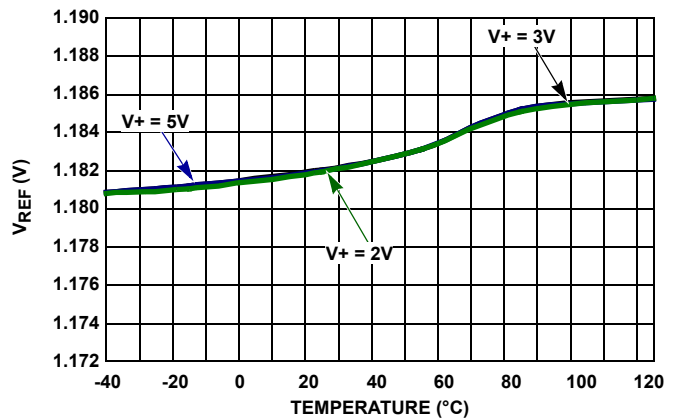

FIGURE 2. REFERENCE VOLTAGE vs TEMPERATURE

Block Diagram

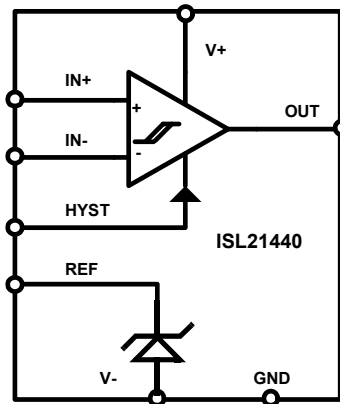
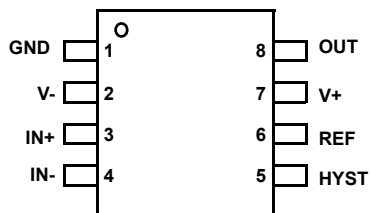

FIGURE 3. BLOCK DIAGRAM

Pin Configuration

ISL21440
(8 LD MSOP, 8 LD TDFN)
TOP VIEW



Pin Descriptions

PIN	SYMBOL	DESCRIPTION
1	GND	Ground pin. Sets the comparator output low level.
2	V-	Negative supply input for voltage reference and comparator.
3	IN+	Comparator noninverting input pin. Range: V- to V+ -1.5V.
4	IN-	Comparator inverting input pin. Range: V- to V+ -1.5V.
5	HYST	Comparator hysteresis input. Accepts a voltage divided from the reference output. Range is $V_{REF} - 50\text{mV}$ to V_{REF} . Connect directly to V_{REF} for zero hysteresis.
6	REF	Reference output. Source 2mA and Sink 10 μ A.
7	V+	Positive supply input for comparator and reference. Range is 2.0V to 11.0V
8	OUT	Comparator output, CMOS push-pull. Output swing referenced to V+ and GND.

Ordering Information

PART NUMBER (Notes 2, 3)	PART MARKING	V _{DD} RANGE (V)	TEMP RANGE (°C)	TAPE and REEL (UNITS)	PACKAGE (RoHS COMPLIANT)	PKG. DWG. #
ISL21440IRTZ	1440	2 to 11	-40 to +125	-	8 Ld TDFN	L8.3x3G
ISL21440IRTZ-T13 (Note 1)	1440	2 to 11	-40 to +125	6k	8 Ld TDFN	L8.3x3G
ISL21440IUZ	1440Z	2 to 11	-40 to +125	-	8 Ld MSOP	M8.118
ISL21440IUZ-T13 (Note 1)	1440Z	2 to 11	-40 to +125	2.5k	8 Ld MSOP	M8.118

NOTES:

- Refer to [TB347](#) for details about reel specifications.
- These Pb-free plastic packaged products employ special Pb-free material sets, molding compounds/die attach materials, and 100% matte tin plate plus anneal (e3 termination finish, which is RoHS compliant and compatible with both SnPb and Pb-free soldering operations). Pb-free products are MSL classified at Pb-free peak reflow temperatures that meet or exceed the Pb-free requirements of IPC/JEDEC J STD-020.
- For Moisture Sensitivity Level (MSL), see the [ISL21440](#) product information page. For more information about MSL, see [TB363](#).

Absolute Maximum Ratings

Supply Voltage Range, V+ to GND	-0.5V to +12V
IN+, IN- with Respect to V-	-0.3V to (V+) +0.3V
GND with Respect to V-	6.0V to -0.3V
V+ with Respect to V-	12V to -0.3V
REF, HYST with Respect to V-	-0.3V to 1.5V
Out with Respect to GND	(V+) +0.3V to -0.3V
Voltage on All Other Pins	-0.3V to V _{CC} + 0.3V
ESD Rating	
Human Body Model	4kV
Machine Model	350V
Charged Device Model	2kV
Latch-Up (Tested Per JESD-78B; Class 1, Level A)	100mA

Thermal Information

Thermal Resistance (Typical)	θ_{JA} (°C/W)	θ_{JC} (°C/W)
8 Ld MSOP Package (Notes 5, 7)	154	55
8 Ld TDFN Package (Notes 5, 6)	68	8
Maximum Junction Temperature (Plastic Package)	+150°C	
Storage Temperature Range	-65°C to +150°C	
Pb-Free Reflow Profile (Note 8)	see TB493	

Recommended Operating Conditions

Temperature	-40°C to +125°C
Supply Voltage	2.7V to 5.5V

Environmental Operating Conditions

X-Ray Exposure (Note 4)	10mRem
-------------------------	--------

CAUTION: Do not operate at or near the maximum ratings listed for extended periods of time. Exposure to such conditions may adversely impact product reliability and result in failures not covered by warranty.

NOTES:

- Measured with no filtering, distance of 10" from source, intensity set to 55kV and 70 μ A current, 30s duration. Other exposure levels should be analyzed for output voltage drift effects. See "Applications Information" on page 10.
- θ_{JA} is measured with the component mounted on a high-effective thermal conductivity test board in free air. See tech brief TB379 for details.
- For θ_{JC} , the "case temp" location is the center of the exposed metal pad on the package underside.
- For θ_{JC} , the "case temp" location is taken at the package top center.
- Post-reflow drift for the ISL21440 device voltage reference output will range from 100mV to 1.0mV based on experimental results with devices on FR4 double-sided boards. The design engineer must take this into account when considering the reference voltage after assembly.

Analog Specifications (V+ = +5.0V) V- = GND = 0V unless otherwise specified, T_A = +25°C. Boldface limits apply across the operating temperature range, -40°C to +125°C.

PARAMETER	SYMBOL	TEST CONDITIONS	MIN (Note 10)	TYP (Note 9)	MAX (Note 10)	UNIT
POWER SUPPLY						
Supply Voltage Range	V ₊	V- = GND	2.0		11.0	V
Supply Current	I _{CC}	IN+ = IN- +80mV, HYST = REF		0.46	0.75	μ A
					6.5	μ A
COMPARATOR						
Input Offset Voltage	V _{OS}	V _{CM} = 2.5V	MSOP Package		\pm 3	mV
					\pm3.25	mV
			TDFN Package		\pm 3.6	mV
					\pm3.75	mV
Input Leakage Current (IN+, IN-, HYST)	I _{IN}	V _{IN+} = V _{IN-} = 2.5V	MSOP Package	0.1	1.4	nA
				0.1	1.5	nA
			TDFN Package		3	nA
Common-Mode Input Range	V _{CM}		V-		(V+) - 1.5	V
Common-Mode Rejection Ratio	CMRR	V- to (V+ - 1.5V)	MSOP Package	1.2	3	mV/V
					3.5	mV/V
			TDFN Package	1.2	4.5	mV/V
					5	mV/V

Analog Specifications (V+ = +5.0V) V- = GND = 0V unless otherwise specified, T_A = +25°C. **Boldface limits apply across the operating temperature range, -40°C to +125°C. (Continued)**

PARAMETER	SYMBOL	TEST CONDITIONS		MIN (Note 10)	TYP (Note 9)	MAX (Note 10)	UNIT
Power Supply Rejection Ratio	PSRR	V+ = 2V to 11V	MSOP Package		0.25	1.1	mV/V
						1.2	mV/V
		TDFN Package			0.25	1.5	mV/V
							1.6
Hysteresis Input Voltage	V _{HYST}			REF - 50mV		REF	V
Propagation Delay - HIGH to LOW Transition	t _{PHL}	C _L = 100pF	Overdrive = 10mV		100		μs
			Overdrive = 100mV		50		μs
Propagation Delay - LOW to HIGH Transition	t _{PLH}	C _L = 100pF	Overdrive = 10mV		200		μs
			Overdrive = 100mV		100		μs
Output High Voltage	V _{OH}	I _O = -10mA		(V+) - 0.6			V
Output Low Voltage	V _{OL}	I _O = 3mA				GND + 0.6	V
REFERENCE							
Reference Voltage	V _{REF}	No Load		1.176		1.188	V
Output Load Regulation	ΔV _{REF}	0 ≤ I _{SOURCE} ≤ 2mA			-0.5	-2.0	mV
						-2.5	mV
		0 ≤ I _{SINK} ≤ 10μA			0.1	2.0	mV
						2.5	mV

Analog Specifications (V+ = +3.0V) V- = GND = 0V unless otherwise specified, T_A = +25°C. **Boldface limits apply across the operating temperature range, -40°C to +125°C.**

PARAMETER	SYMBOL	TEST CONDITIONS		MIN (Note 10)	TYP (Note 9)	MAX (Note 10)	UNIT
V+ = 3.0V, V- = GND = 0V							
Supply Current	I _{CC}	IN+ = IN- +80mV, HYST = REF			0.40	0.7	μA
						5	μA
COMPARATOR							
Input offset Voltage	V _{OS}	V _{CM} = 1.5V	MSOP Package		±2.3	±3.4	mV
						±3.5	mV
			TDFN Package		±2.3	±4.2	mV
						±4.3	mV
Input Leakage Current (IN+, IN-, HYST)	I _{IN}	V _{IN+} = V _{IN-} = 1.5V			0.1	1.1	nA
						3	nA
Common-Mode Input Range	V _{CM}			V-		(V+) - 1.5	V
Common-Mode Rejection Ratio	CMRR	V- to (V+ - 1.5V)	MSOP Package		1.2	5	mV/V
						5.5	mV/V
			TDFN Package		1.2	7.5	mV/V
						8	mV/V

Analog Specifications (V+ = +3.0V) V- = GND = 0V unless otherwise specified, T_A = +25 °C. **Boldface limits apply across the operating temperature range, -40 °C to +125 °C. (Continued)**

PARAMETER	SYMBOL	TEST CONDITIONS		MIN (Note 10)	TYP (Note 9)	MAX (Note 10)	UNIT
Power Supply Rejection Ratio	PSRR	V+ = 2V to 11V	MSOP Package		0.25	1.1	mV/V
						1.2	mV/V
		TDFN Package			0.25	1.5	mV/V
							1.6
Hysteresis Input Voltage	V _{HYST}			REF - 50mV		REF	V
Propagation Delay - HIGH to LOW Transition	t _{PHL}	C _L = 100pF	Overdrive = 10mV		100		μs
			Overdrive = 100mV		50		μs
Propagation Delay - LOW to HIGH Transition	t _{PLH}	C _L = 100pF	Overdrive = 10mV		200		μs
			Overdrive = 100mV		100		μs
Output High Voltage	V _{OH}	I _O = -6mA		(V+) - 0.6			V
Output Low Voltage	V _{OL}	I _O = 1.8mA				GND + 0.6	V
REFERENCE							
Reference Voltage	V _{REF}	No Load		1.176		1.188	V
Output Load Regulation	ΔV _{REF}	0 ≤ I _{SOURCE} ≤ 2mA			-0.5	-2.0	mV
						-2.5	mV
		0 ≤ I _{SINK} ≤ 10μA			0.1	2.0	mV
						-2.5	mV

NOTES:

9. Across the specified temperature range. Temperature coefficient is measured by the box method whereby the change in V_{OUT} is divided by the temperature range; in this case, -40 °C to +125 °C = +165 °C.
10. Parts are 100% tested at +25 °C and +85 °C. The -40 °C and +125 °C temperature limits are established by characterization and are not production tested.

Typical Performance Curves

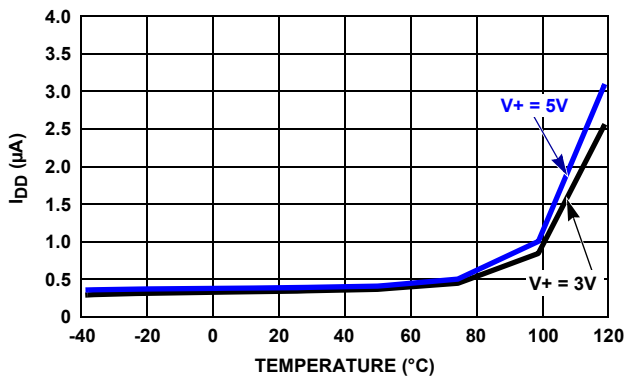

FIGURE 4. I_{DD} vs TEMPERATURE

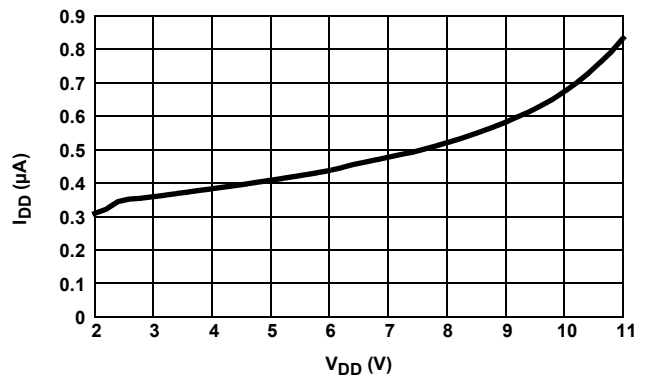

FIGURE 5. I_{DD} vs V_{DD}

Typical Performance Curves (Continued)

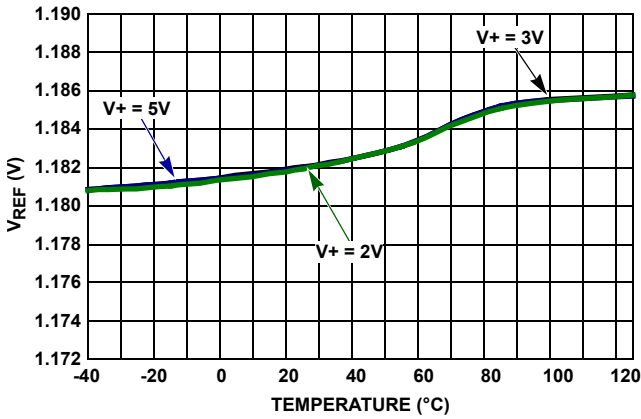

FIGURE 6. V_{REF} vs TEMPERATURE

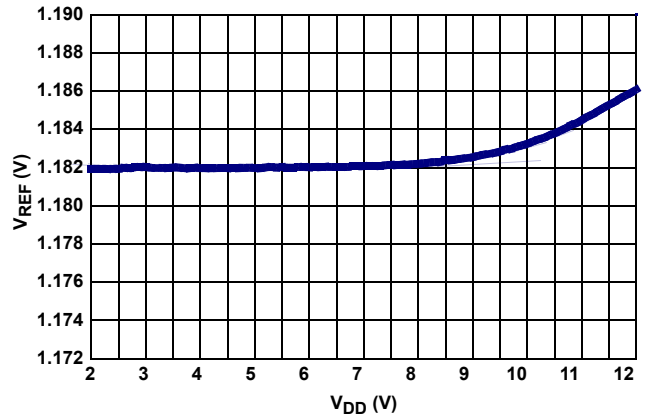

FIGURE 7. V_{REF} vs SUPPLY VOLTAGE

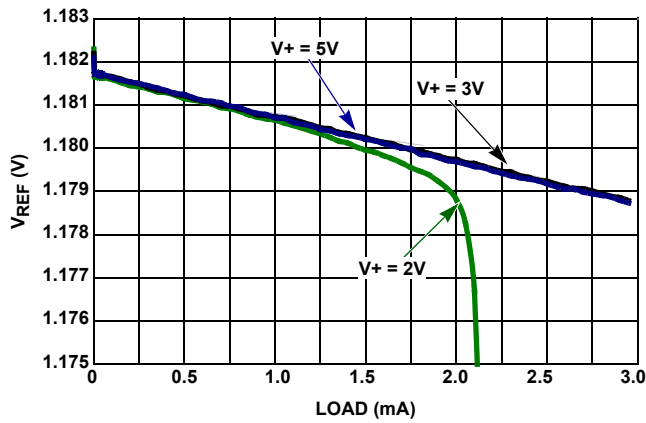

FIGURE 8. V_{REF} vs LOAD (SOURCE)

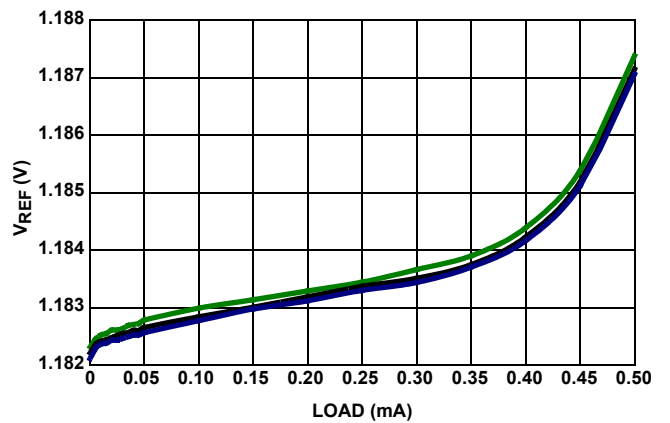

FIGURE 9. V_{REF} vs LOAD (SINK)

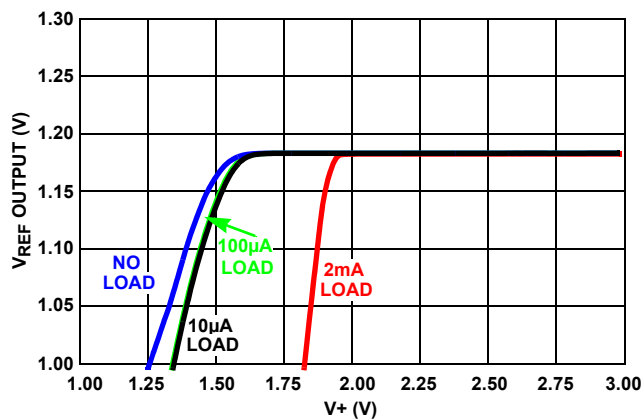

FIGURE 10. V_{REF} DROPOUT vs V_{REF} OUTPUT vs LOAD

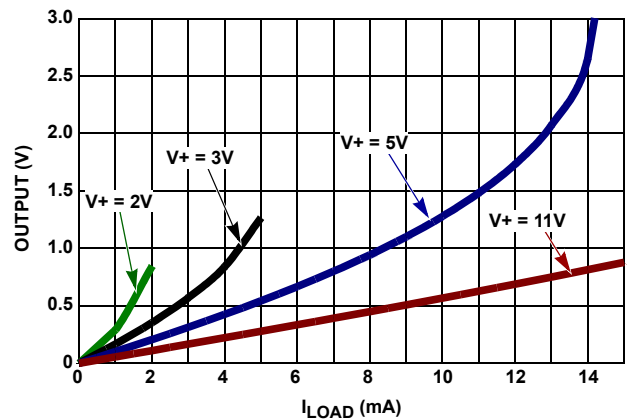

FIGURE 11. COMPARATOR OUTPUT LOW VOLTAGE vs LOAD

Typical Performance Curves (Continued)

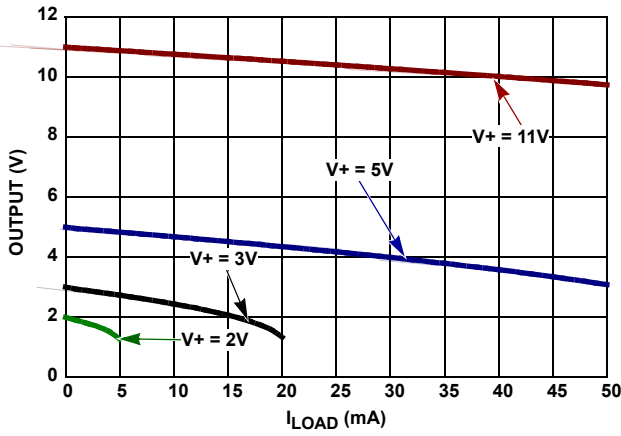

FIGURE 12. COMPARATOR OUTPUT HIGH VOLTAGE vs LOAD

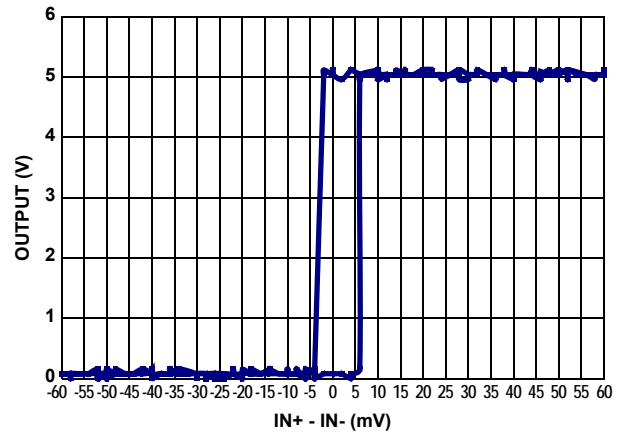

FIGURE 13. HYSTERESIS - 0mV (V+ = 5V)

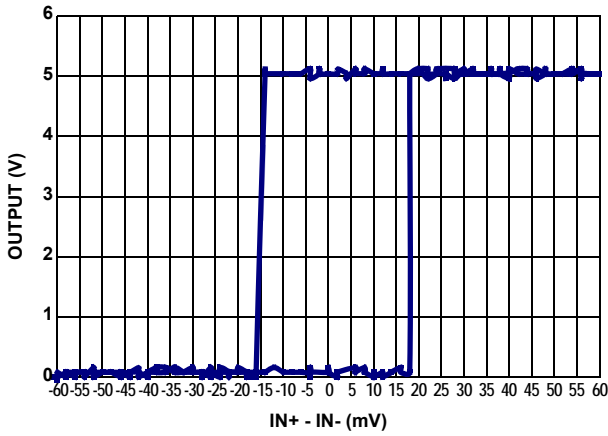

FIGURE 14. HYSTERESIS - 12.5mV (V+ = 5V)

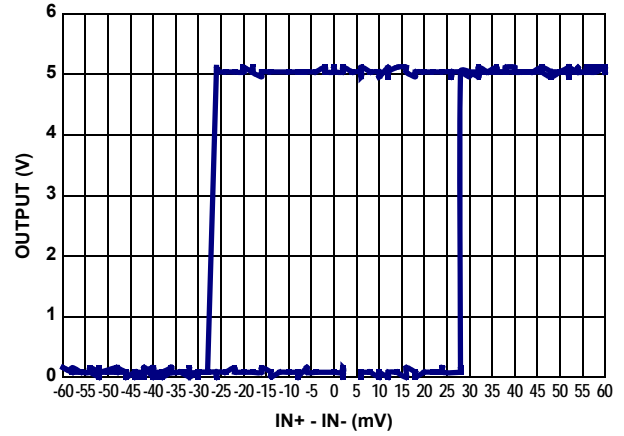

FIGURE 15. HYSTERESIS - 25mV (V+ = 5V)

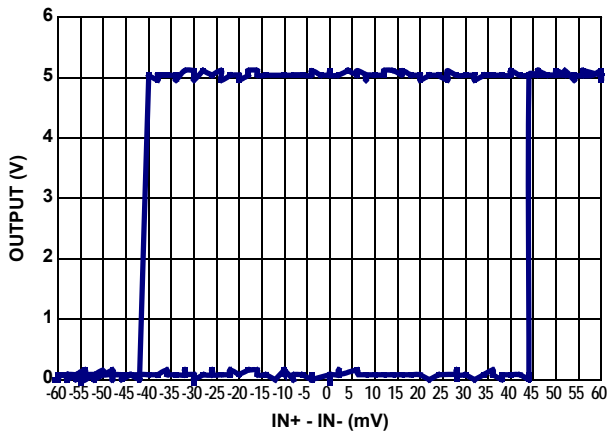

FIGURE 16. HYSTERESIS - 37.5mV (V+ = 5V)

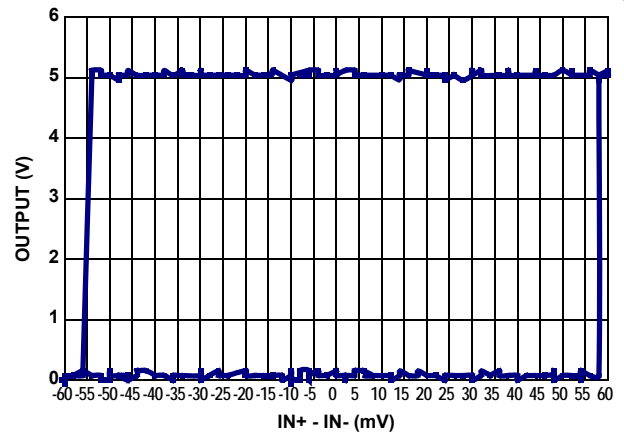

FIGURE 17. HYSTERESIS - 50mV (V+ = 5V)

Typical Performance Curves (Continued)

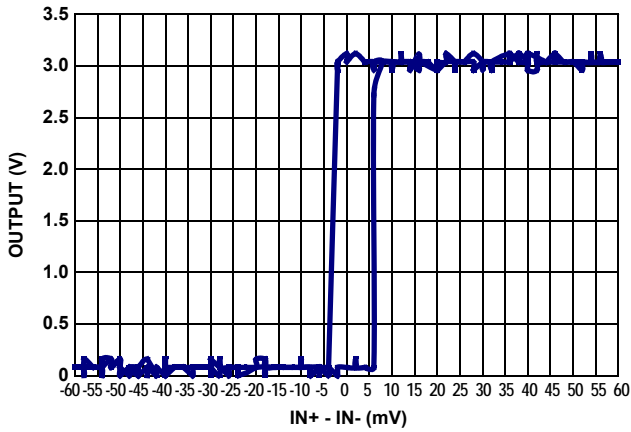

FIGURE 18. HYSTERESIS - 0mV (V+ = 3V)

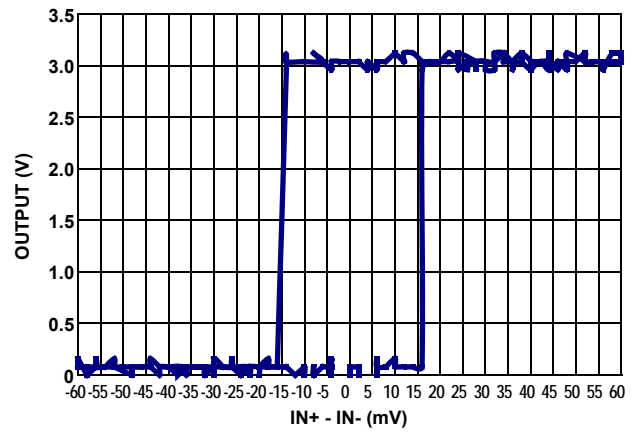

FIGURE 19. HYSTERESIS - 12.5mV (V+ = 3V)

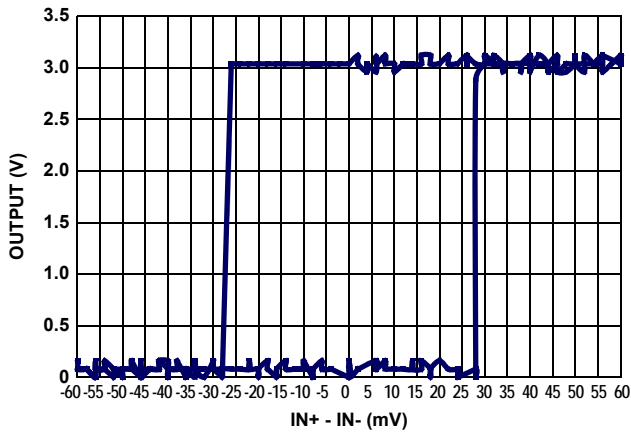

FIGURE 20. HYSTERESIS - 25mV (V+ = 3V)

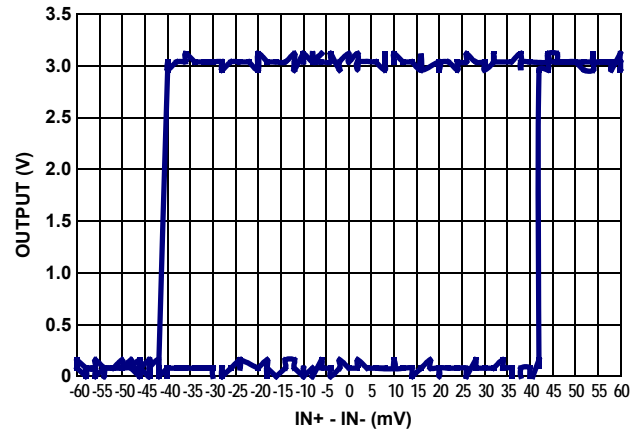

FIGURE 21. HYSTERESIS - 37.5mV (V+ = 3V)

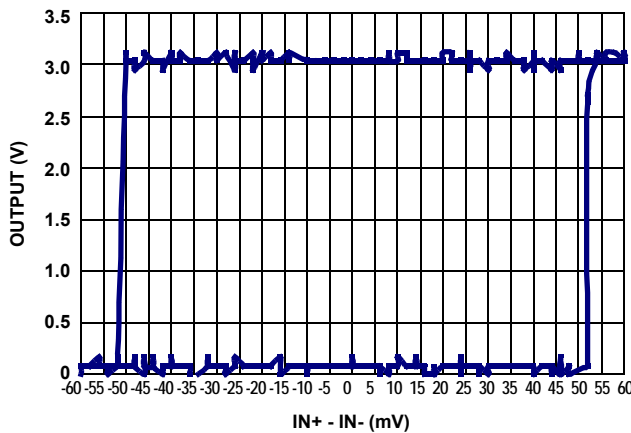

FIGURE 22. HYSTERESIS - 50mV (V+ = 3V)

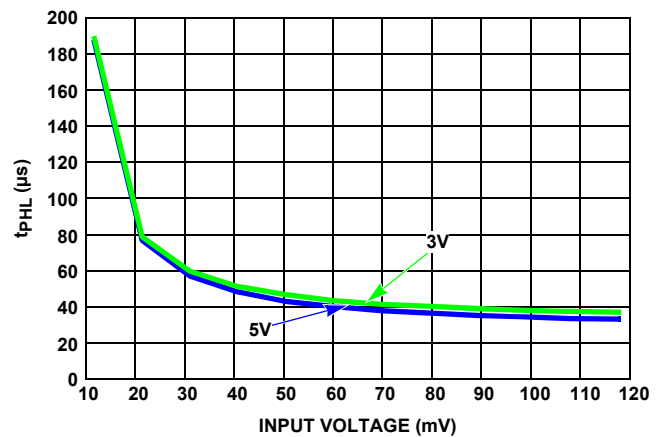

FIGURE 23. OUTPUT RESPONSE TIME vs INPUT OVERDRIVE (t_{pHL})

Typical Performance Curves (Continued)

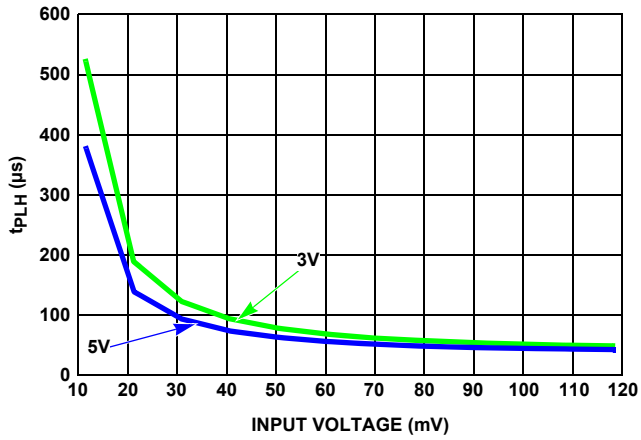

FIGURE 24. OUTPUT RESPONSE TIME vs INPUT OVERDRIVE (t_{pLH})

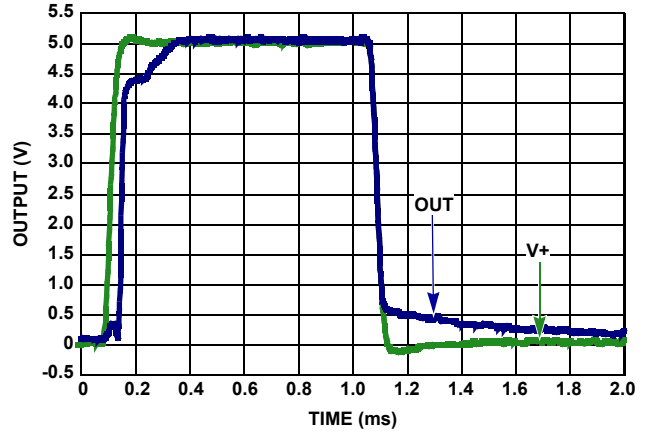

FIGURE 25. POWER-UP/DOWN OUTPUT RESPONSE (V₊ = 5V, IN₊ = V₊, IN₋ = V_{REF})

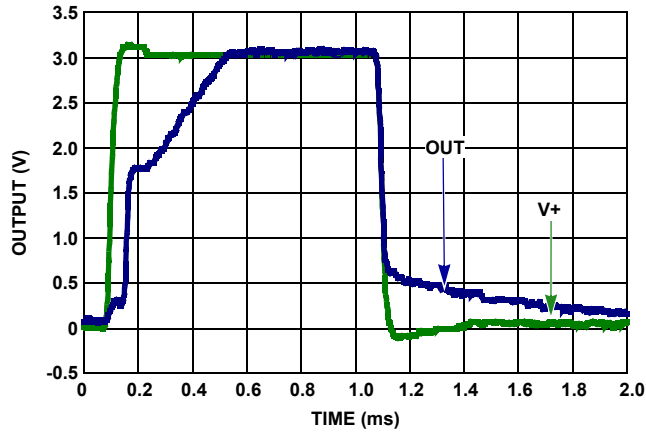

FIGURE 26. POWER-UP/DOWN OUTPUT RESPONSE (V₊ = 3V, IN₊ = V₊, IN₋ = V_{REF})

Functional Description

Device Power

The ISL21440 device has a single positive supply pin, V+, and two other supply pins, V- and GND. Normally, for single supply applications the V- pin is tied to system ground as well as the GND pin. The separate ground pin allows the comparator to be powered by split supplies from $\pm 1.0\text{V}$ to $\pm 5.5\text{V}$. Note that the minimum supply voltage will be 0.8V above the comparator maximum input level for accurate operation.

Comparator Section

The comparator inputs can swing from the negative supply (GND pin) to within 0.8V of the positive supply (V+). Alternatively, with the comparator input set at the 1.182V reference level, the minimum input voltage for accurate operation is 2.0V. If the inputs are expected to see voltage levels above V+ or below ground, they should be clamped with low leakage Schottky diodes.

The CMOS output swings essentially from the GND potential to V+ potential, depending on load current. If loads in excess of 1mA are expected, then a 0.1 μF decoupling capacitor at the V+ pin should be added.

Voltage Reference Section

The voltage reference is a micropower FGA reference and is set to 1.182V $\pm 0.5\%$ at the factory. The reference output can source up to 2mA but the sink capability is very limited at only 10 μA , maximum. Small value capacitors, up to 10nF, can be used on the reference output to lower noise if desired.

Applications Information

Handling and Board Mounting

FGA references provide excellent initial accuracy and low temperature drift at the expense of very little power drain. There are some precautions to take to insure this accuracy is not compromised. Excessive heat during solder reflow can cause excessive initial accuracy drift, so the recommended +260 °C maximum temperature profile should not be exceeded. Expect up to 1mV drift from the solder reflow process.

FGA references are susceptible to excessive X-radiation like that used in PC board manufacturing. Initial accuracy can change 10mV or more under extreme radiation. If an assembled board needs to be X-rayed, care should be taken to shield the FGA reference device.

Hysteresis

The Hysteresis function allows for changing the value of the reference switchover point depending on the previous state of the comparator. This works to remove the effects of noise or glitches in the voltage detection input and provide more reliable output transitions.

Hysteresis is added to the ISL21440 by connecting one resistor between the REF and HYST pins (R_{REF}), and another resistor (R_{HYST}) between the HYST pin and ground. The hysteresis voltage (V_H) is designed to be twice the voltage difference

between the HYST pin and REF pin ($V_H = 2 * (V_{REF} - V_{HYST})$). Since the reference voltage is 1.182V (V_{REF}), [Equations 1](#) and [2](#) for these two resistors are shown as follows:

$$R_{REF} = V_H / (2 * I_{REF}) = (V_{REF} - V_{HYST}) / I_{REF} \quad (\text{EQ. 1})$$

$$R_{HYST} = (1.182 - V_H / 2) / I_{REF} = V_{HYST} / I_{REF} \quad (\text{EQ. 2})$$

I_{REF} is chosen to be less than the maximum output of the reference, usually 5 μA is a safe value but for lowest power, 0.1 μA can be used.

If the hysteresis is not used, the HYST pin should be tied to the REF pin.

Board Assembly Considerations

FGA references provide high accuracy and low temperature drift but some PCB assembly precautions are necessary. Normal output voltage shifts of 100 μV to 1mV can be expected with Pb-free reflow profiles or wave solder on multilayer FR4 PC boards. Avoid excessive heat or extended exposure to high reflow or wave solder temperatures. This may reduce device initial accuracy.

Post-assembly X-ray inspection may also lead to permanent changes in device output voltage and should be minimized or avoided. If X-ray inspection is required, it is advisable to monitor the reference output voltage to verify excessive shift has not occurred. If large amounts of shift are observed, it is best to add an X-ray shield consisting of thin zinc (300 μm) sheeting to allow clear imaging, yet block x-ray energy that affects the FGA reference.

Special Applications Considerations

In addition to post-assembly examination, other X-ray sources may affect the FGA reference long term accuracy. Airport screening machines contain X-rays and will have a cumulative effect on the voltage reference output accuracy. Carry-on luggage screening uses low level X-rays and is not a major source of output voltage shift; however, if a product is expected to pass through that type of screening over 100 times it may need to consider shielding with copper or aluminum. Checked luggage X-rays are higher intensity and can cause output voltage shift in much fewer passes, so devices expected to go through those machines should definitely consider shielding. Note that just two layers of 1/2 ounce copper planes will reduce the received dose by over 90%. The lead frame for the device, which is on the bottom, also provides similar shielding.

If a device is expected to pass through luggage X-ray machines numerous times, it is advised to mount a 2-layer (minimum) PCB over the top of the package, which, along with a ground plane underneath, will effectively shield it from 50 to 100 passes through the machine. Because these machines vary in X-ray dose delivered, it is difficult to produce an accurate maximum pass recommendation.

Typical Applications

Low Battery Detector

Figure 27 shows a typical implementation for the ISL21440, a low battery detector. The values for R_{REF} and R_{HYST} provide 20mV of hysteresis and $0.5\mu A$ I_{REF} . The input trip point for V_{DETECT} is the same as the reference voltage, 1.182V, and a resistor divider at the input sets the L_{OBAT} trip point at 2.7V. The total current draw for the circuit is going to be $1.1\mu A$ for V_{DD} and $0.6\mu A$ for V_{BAT} .

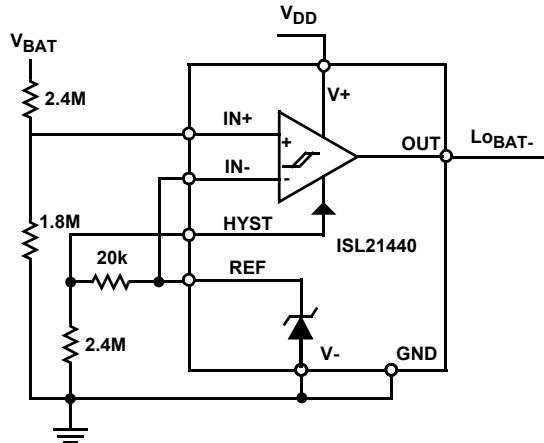

FIGURE 27. LOW BATTERY DETECTOR WITH HYSTERESIS

Window Comparator

The ISL21440 can be combined with a micropower comparator to produce a window comparator circuit. The circuit in Figure 28 uses a 3-resistor divider to produce high and low trip points and the ISL28197 (800nA supply current) comparator is added to give the second output. The two outputs can be used separately for overvoltage or undervoltage indication, or a gate can be added as shown to report either in-window or out-of window condition.

The resistors are shown as Equations 3, 4, and 5 as follows.

Set:

$$R_3 = 1M(1\%) \quad (\text{EQ. 3})$$

$$R_2 = R_3[V_H/V_L - 1] \quad (\text{EQ. 4})$$

$$R_1 = R_3[(V_H/V_{REF} - 1) - R_2] \quad (\text{EQ. 5})$$

Example: For $V_H = 3.8V$, $V_L = 2.7V$ ($3.3V \pm 0.5V$)

$$R_2 = 402k, R_1 = 1.82M \text{ (can be 1\%)}$$

The resulting circuit draws about $3\mu A$ and works down to $V_{DD} = 2.2V$.

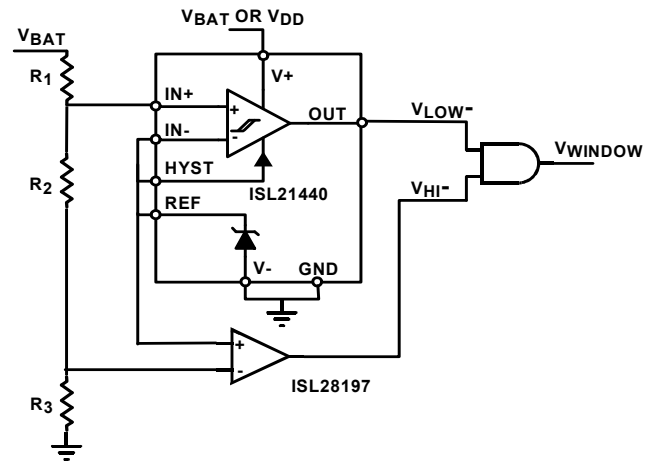

FIGURE 28. WINDOW COMPARATOR CIRCUIT

Revision History The revision history provided is for informational purposes only and is believed to be accurate, but not warranted. Please visit our website to make sure you have the latest revision.

DATE	REVISION	CHANGE
Mar 12, 2018	FN6532.6	Updated Ordering Information table by adding -T13 parts, tape and reel quantity column, updated Note 1, and removed Note 2. Updated Note 4 by fixing the induced error caused from importing new formats. Changed 70mA to 70iA. Removed About Intersil section. Updated Disclaimer.
Oct 25, 2017	FN6532.5	On page 1, added Related Literature. Changed the supply current from 5 μ A to 6.5 μ A in the first paragraph and the first bullet in Features On page 3, changed the I _{CC} max limit in electrical table for the V _{CC} = 5V condition, from 5 μ A to 6.5 μ A. Changed the comparator V _{OH} limit in the electrical table on pages 4 and 5 from +V -0.4V to +V -0.6V.
Mar 24, 2017	FN6532.4	Updated V _{OL} maximum specification for both 3V and 5V supply conditions.
Mar 3, 2016	FN6532.3	On pages 3 and page 4 in Electrical Specifications table (Analog Specifications): Changed ICC Supply Current Max Limit across Temperature from: 0.85 μ A, to: 5 μ A. Updated typical performance curves Figures 3, 4, 9, 22, 23. Updated POD M8.118 to most current version with revision of POD as follows: Corrected lead width dimension in side view 1 from "0.25 - 0.036" to "0.25 - 0.36" Updated POD L8.3x3G to most current version with revision of POD as follows: Tiebar Note updated From: Tiebar shown (if present) is a non-functional feature. To: Tiebar shown (if present) is a non-functional feature and may be located on any of the 4 sides (or ends). Updated Product to About Intersil
Jan 24, 2011	FN6532.2	On page 2: Updated Tape & Reel note in "Ordering Information" to add new standard "Add "-T*" suffix for tape and reel." The "*" covers all possible tape and reel options On page 4: Separated "Analog Specifications" tables into 2 tables. Put specs from "V+ = 3.0V, V- = GND = 0V" to end of table into separate table and added following common conditions: "V+= +3.0V. V- = GND = 0V unless otherwise specified, T _A = +25°C. Boldface limits apply over the operating temperature range, -40°C to +125°C. " On page 4: Changed conditions for "V _{OH} " from I _o = -7mA to I _o = -6mA Changed conditions for "V _{OL} " from I _o = 3mA to I _o = 1.8mA In "Window Comparator" on page 11, changed "with a micropower to.." to: "with a micropower comparator to.." Page 14, replaced POD M8.118 with newest revision. Updated to new intersil format by adding land pattern and moving dimensions from table onto drawing
Mar 2, 2010	FN6532.1	Updated datasheet with the TDFN spec. Spec added on pages 5-6 are: VOS, IIN, CMRR and PSRR. Each spec has an added row for the TDFN package and the original limit for the MSOP package.
Dec 7, 2009	FN6532.0	Initial release

Package Outline Drawing

For the most recent package outline drawing, see [M8.118](#).

M8.118

8 LEAD MINI SMALL OUTLINE PLASTIC PACKAGE

Rev 4, 7/11

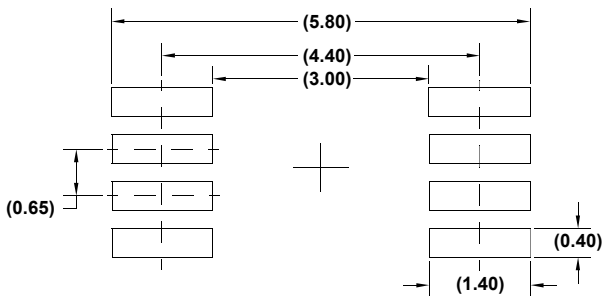
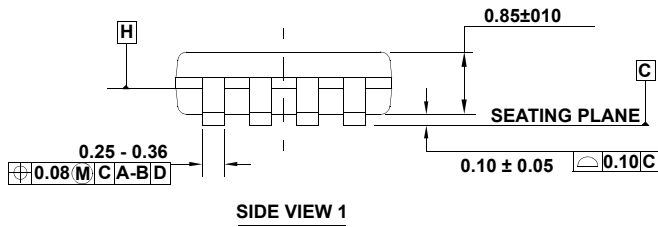
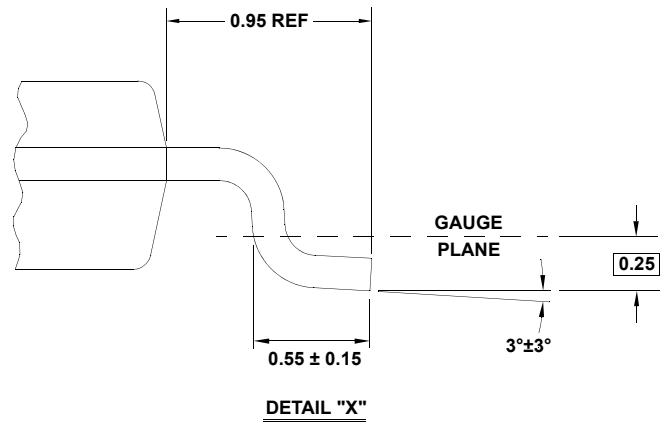
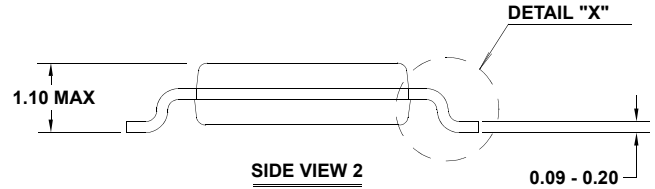
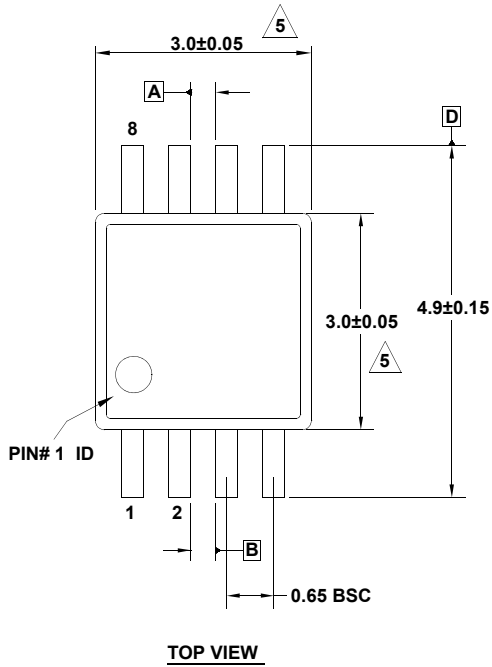

NOTES:

1. Dimensions are in millimeters.
2. Dimensioning and tolerancing conform to JEDEC MO-187-AA and AMSEY14.5m-1994.
3. Plastic or metal protrusions of 0.15mm max per side are not included.
4. Plastic interlead protrusions of 0.15mm max per side are not included.
5. Dimensions are measured at Datum Plane "H".
6. Dimensions in () are for reference only.

Package Outline Drawing

For the most recent package outline drawing, see [L8.3x3G](#).

L8.3x3G

8 LEAD THIN DUAL FLAT NO-LEAD PLASTIC PACKAGE (TDFN)

Rev 1, 5/15

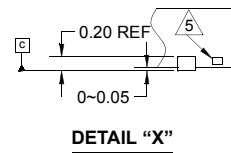
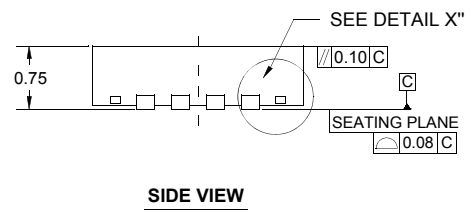
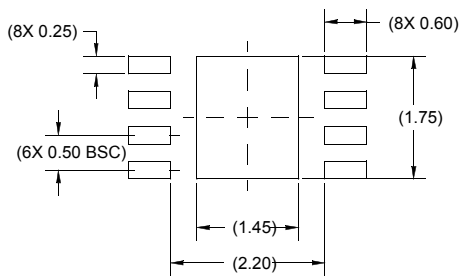
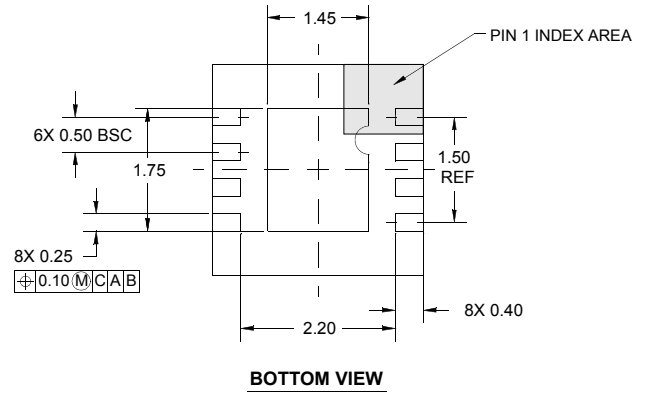
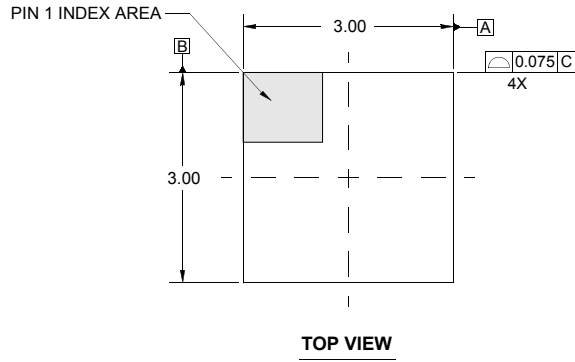

NOTES:

1. Controlling dimensions are in mm.
Dimensions in () for reference only.
2. Unless otherwise specified, tolerance: Decimal ± 0.05
Angular $\pm 2^\circ$
3. Dimensioning and tolerancing conform to JEDEC STD MO220-D.
4. The configuration of the pin #1 identifier is optional, but must be located within the zone indicated. The pin #1 identifier may be either a mold or mark feature.
5. Tiebar shown (if present) is a non-functional feature and may be located on any of the 4 sides (or ends).

Notice

1. Descriptions of circuits, software and other related information in this document are provided only to illustrate the operation of semiconductor products and application examples. You are fully responsible for the incorporation or any other use of the circuits, software, and information in the design of your product or system. Renesas Electronics disclaims any and all liability for any losses and damages incurred by you or third parties arising from the use of these circuits, software, or information.
2. Renesas Electronics hereby expressly disclaims any warranties against and liability for infringement or any other claims involving patents, copyrights, or other intellectual property rights of third parties, by or arising from the use of Renesas Electronics products or technical information described in this document, including but not limited to, the product data, drawings, charts, programs, algorithms, and application examples.
3. No license, express, implied or otherwise, is granted hereby under any patents, copyrights or other intellectual property rights of Renesas Electronics or others.
4. You shall not alter, modify, copy, or reverse engineer any Renesas Electronics product, whether in whole or in part. Renesas Electronics disclaims any and all liability for any losses or damages incurred by you or third parties arising from such alteration, modification, copying or reverse engineering.
5. Renesas Electronics products are classified according to the following two quality grades: "Standard" and "High Quality". The intended applications for each Renesas Electronics product depends on the product's quality grade, as indicated below.
"Standard": Computers; office equipment; communications equipment; test and measurement equipment; audio and visual equipment; home electronic appliances; machine tools; personal electronic equipment; industrial robots; etc.
"High Quality": Transportation equipment (automobiles, trains, ships, etc.); traffic control (traffic lights); large-scale communication equipment; key financial terminal systems; safety control equipment; etc.
Unless expressly designated as a high reliability product or a product for harsh environments in a Renesas Electronics data sheet or other Renesas Electronics document, Renesas Electronics products are not intended or authorized for use in products or systems that may pose a direct threat to human life or bodily injury (artificial life support devices or systems; surgical implantations; etc.), or may cause serious property damage (space system; undersea repeaters; nuclear power control systems; aircraft control systems; key plant systems; military equipment; etc.). Renesas Electronics disclaims any and all liability for any damages or losses incurred by you or any third parties arising from the use of any Renesas Electronics product that is inconsistent with any Renesas Electronics data sheet, user's manual or other Renesas Electronics document.
6. When using Renesas Electronics products, refer to the latest product information (data sheets, user's manuals, application notes, "General Notes for Handling and Using Semiconductor Devices" in the reliability handbook, etc.), and ensure that usage conditions are within the ranges specified by Renesas Electronics with respect to maximum ratings, operating power supply voltage range, heat dissipation characteristics, installation, etc. Renesas Electronics disclaims any and all liability for any malfunctions, failure or accident arising out of the use of Renesas Electronics products outside of such specified ranges.
7. Although Renesas Electronics endeavors to improve the quality and reliability of Renesas Electronics products, semiconductor products have specific characteristics, such as the occurrence of failure at a certain rate and malfunctions under certain use conditions. Unless designated as a high reliability product or a product for harsh environments in a Renesas Electronics data sheet or other Renesas Electronics document, Renesas Electronics products are not subject to radiation resistance design. You are responsible for implementing safety measures to guard against the possibility of bodily injury, injury or damage caused by fire, and/or danger to the public in the event of a failure or malfunction of Renesas Electronics products, such as safety design for hardware and software, including but not limited to redundancy, fire control and malfunction prevention, appropriate treatment for aging degradation or any other appropriate measures. Because the evaluation of microcomputer software alone is very difficult and impractical, you are responsible for evaluating the safety of the final products or systems manufactured by you.
8. Please contact a Renesas Electronics sales office for details as to environmental matters such as the environmental compatibility of each Renesas Electronics product. You are responsible for carefully and sufficiently investigating applicable laws and regulations that regulate the inclusion or use of controlled substances, including without limitation, the EU RoHS Directive, and using Renesas Electronics products in compliance with all these applicable laws and regulations. Renesas Electronics disclaims any and all liability for damages or losses occurring as a result of your noncompliance with applicable laws and regulations.
9. Renesas Electronics products and technologies shall not be used for or incorporated into any products or systems whose manufacture, use, or sale is prohibited under any applicable domestic or foreign laws or regulations. You shall comply with any applicable export control laws and regulations promulgated and administered by the governments of any countries asserting jurisdiction over the parties or transactions.
10. It is the responsibility of the buyer or distributor of Renesas Electronics products, or any other party who distributes, disposes of, or otherwise sells or transfers the product to a third party, to notify such third party in advance of the contents and conditions set forth in this document.
11. This document shall not be reprinted, reproduced or duplicated in any form, in whole or in part, without prior written consent of Renesas Electronics.
12. Please contact a Renesas Electronics sales office if you have any questions regarding the information contained in this document or Renesas Electronics products.
(Note 1) "Renesas Electronics" as used in this document means Renesas Electronics Corporation and also includes its directly or indirectly controlled subsidiaries.
(Note 2) "Renesas Electronics product(s)" means any product developed or manufactured by or for Renesas Electronics.

(Rev.4.0-1 November 2017)



SALES OFFICES

Renesas Electronics Corporation

<http://www.renesas.com>

Refer to "<http://www.renesas.com/>" for the latest and detailed information.

Renesas Electronics America Inc.
1001 Murphy Ranch Road, Milpitas, CA 95035, U.S.A.
Tel: +1-408-432-8888, Fax: +1-408-434-5351

Renesas Electronics Canada Limited
9251 Yonge Street, Suite 8309 Richmond Hill, Ontario Canada L4C 9T3
Tel: +1-905-237-2004

Renesas Electronics Europe Limited
Dukes Meadow, Millboard Road, Bourne End, Buckinghamshire, SL8 5FH, U.K.
Tel: +44-1628-651-700, Fax: +44-1628-651-804

Renesas Electronics Europe GmbH
Arcadiastrasse 10, 40472 Düsseldorf, Germany
Tel: +49-211-6503-0, Fax: +49-211-6503-1327

Renesas Electronics (China) Co., Ltd.
Room 1709 Quantum Plaza, No.27 ZhichunLu, Haidian District, Beijing, 100191 P. R. China
Tel: +86-10-8235-1155, Fax: +86-10-8235-7679

Renesas Electronics (Shanghai) Co., Ltd.
Unit 301, Tower A, Central Towers, 555 Langao Road, Putuo District, Shanghai, 200333 P. R. China
Tel: +86-21-2226-0888, Fax: +86-21-2226-0999

Renesas Electronics Hong Kong Limited
Unit 1601-1611, 16/F., Tower 2, Grand Century Place, 193 Prince Edward Road West, Mongkok, Kowloon, Hong Kong
Tel: +852-2265-6688, Fax: +852-2886-9022

Renesas Electronics Taiwan Co., Ltd.
13F, No. 363, Fu Shing North Road, Taipei 10543, Taiwan
Tel: +886-2-8175-9600, Fax: +886-2-8175-9670

Renesas Electronics Singapore Pte. Ltd.
80 Bendemeer Road, Unit #06-02 Hyflux Innovation Centre, Singapore 339949
Tel: +65-6213-0200, Fax: +65-6213-0300

Renesas Electronics Malaysia Sdn.Bhd.
Unit 1207, Block B, Menara Amcorp, Amcorp Trade Centre, No. 18, Jln Persiaran Barat, 46050 Petaling Jaya, Selangor Darul Ehsan, Malaysia
Tel: +60-3-7955-9390, Fax: +60-3-7955-9510

Renesas Electronics India Pvt. Ltd.
No.777C, 100 Feet Road, HAL 2nd Stage, Indiranagar, Bangalore 560 038, India
Tel: +91-80-67208700, Fax: +91-80-67208777

Renesas Electronics Korea Co., Ltd.
17F, KAMCO Yangjae Tower, 262, Gangnam-daero, Gangnam-gu, Seoul, 06265 Korea
Tel: +82-2-558-3737, Fax: +82-2-558-5338