

### Main

Range of product	Altistart 22
Accessory / separate part type	Fan kit
Accessory / separate part category	Cooling accessories
Accessory / separate part destination	Soft starter
Accessory dimension	145 x 40 x 295 mm

### Complementary

Product compatibility	Soft starter ATS22, U <sub>c</sub> = 110 V (size: 145 x 207 x 295 mm)
-----------------------	---

### Environment

#### Offer Sustainability

Not Green Premium product	Not Green Premium product
Compliant - since 0939 - Schneider Electric declaration of conformity	Compliant - since 0939 - Schneider Electric declaration of conformity
WARNING: This product can expose you to chemicals including:	WARNING: This product can expose you to chemicals including:
Lead and lead compounds, which is known to the State of California to cause cancer and birth defects or other reproductive harm.	Lead and lead compounds, which is known to the State of California to cause cancer and birth defects or other reproductive harm.
Bisphenol A (BPA), which is known to the State of California to cause birth defects or other reproductive harm.	Bisphenol A (BPA), which is known to the State of California to cause birth defects or other reproductive harm.
For more information go to <a href="http://www.p65warnings.ca.gov">www.p65warnings.ca.gov</a>	For more information go to <a href="http://www.p65warnings.ca.gov">www.p65warnings.ca.gov</a>

### Contractual warranty

Warranty period	18 months
-----------------	-----------

### Fan Kit B

#### Dimensions

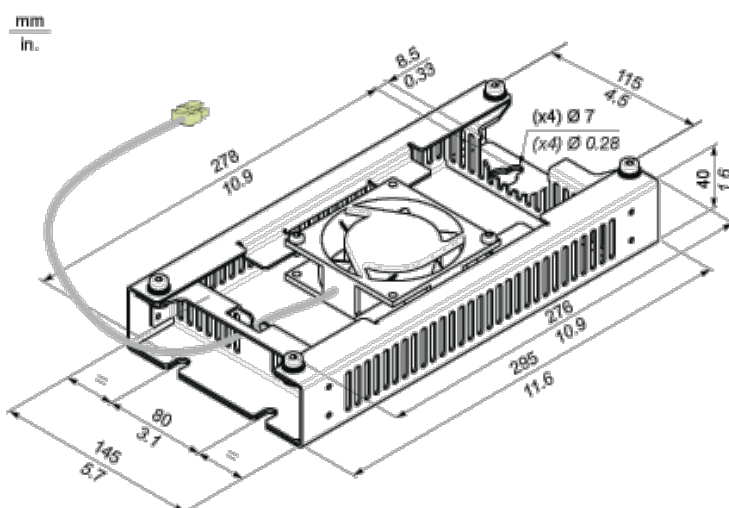

The information provided in this documentation contains general descriptions and/or technical characteristics of the products contained herein. This documentation is not intended as a substitute for and is not to be used for determining suitability or reliability of these products for specific user applications. It is the duty of any such user or integrator to perform the appropriate and complete risk analysis, evaluation and testing of the products with respect to the relevant specific application or use thereof. Neither Schneider Electric Industries SAS nor any of its affiliates or subsidiaries shall be responsible or liable for misuse of the information contained herein.