



## Corcom Product Guide



## RFI Power Line Filters

TE Connectivity (TE) offers over 300 solutions for RFI problems associated with susceptibility, as well as compliance with international emissions standards.



## IEC Inlet Filters and Power Entry Modules

A complete line of power entry modules solves a variety of power entry needs by combining functions to reduce cost, space and labor.



## DC Filters

TE has developed a wide range of power line filters and power entry modules that combine several power management functions specifically designed for DC applications.



## Feedthrough Filters and Capacitors

Designed to offer reliability and performance in high frequency applications and meet EN132200 and 132400 safety requirements. Available for AC or DC applications.



## Signal Line Products

The SignalSentry filtered modular jack connector series combines different levels of filtering with RJ45 and RJ11 modular jacks to address signal line noise problems and crosstalk.

## TE Connectivity Corcom Products Engineering Offices

### USA

620 S. Butterfield Road  
Mundelein, IL 60060  
Phone: 847-680-7400  
Fax: 847-680-8169

6700 Fallbrook Ave.  
Suite 287  
West Hills, CA 91307  
Phone: 818-226-4306  
Fax: 818-704-1757

### Germany

Finsinger Feld 1  
D-85521 Ottobrunn,  
Phone: 49-89-6089-0  
Fax: 49-89-6089-767

### People's Republic of China

668 Guiping Road  
Shanghai, 200233  
Phone: 86-21-2407-1588  
Fax: 86-21-2407-1599

For Sales assistance in the USA please refer to page 286 to find a Corcom product sales representative in your area. For Sales assistance in all other regions, please refer to page 289 to find the Product Information Center in your area.

**Main Table of Contents**

|   |            |
|---|------------|
| Navigating the Catalog .....                                    | 3          |
| <b>1. RFI Power Line Filters .....</b>                          | <b>9</b>   |
| RFI Power Line Filter Selector Chart .....                      | 11         |
| AQ Series .....   | 12         |
| B Series .....  | 15         |
| DK Series .....   | 18         |
| EBP Series .....  | 21         |
| EDP Series .....  | 21         |
| EOP Series .....  | 21         |
| EMC Series .....  | 24         |
| EP & VP Series .....  | 27         |
| FC Series .....   | 30         |
| FL Series .....   | 33         |
| G Series .....  | 35         |
| HQ Series .....   | 37         |
| HT Series .....   | 40         |
| HZ Series <b>NEW 4, 6, 10 and 20A versions</b> .....            | 43         |
| IK Series .....   | 46         |
| K Series .....  | 49         |
| MV Series .....   | 54         |
| N Series .....  | 56         |
| Q Series .....  | 58         |
| R Series .....  | 61         |
| RK Series .....   | 65         |
| S Series .....  | 68         |
| SB Series <b>NEW High Performance B Series</b> .....            | 71         |
| SK Series .....   | 75         |
| T Series .....  | 80         |
| U Series .....  | 84         |
| V Series .....  | 86         |
| W Series .....  | 86         |
| WG Series .....   | 89         |
| X Series .....  | 92         |
| Y Series .....  | 92         |
| Z Series .....  | 92         |
| <b>2. Three Phase Filters .....</b>                             | <b>97</b>  |
| Three Phase Selector Chart .....                                | 97         |
| A Series .....  | 98         |
| ADT Series .....  | 101        |
| AYA Series .....  | 104        |
| AYC Series .....  | 108        |
| AYO Series .....  | 111        |
| BCF Series <b>NEW Compact Three Phase Filters</b> .....         | 113        |
| CFN Series .....  | 116        |
| FCD Series .....  | 118        |
| <b>3. Power Inlet Filters &amp; Power Entry Modules .....</b>   | <b>125</b> |
| Introduction .....  | 126        |
| Selector Chart .....  | 128        |
| Power Entry Module Selector Guide .....                         | 129        |
| C Series .....  | 130        |
| CU Series <b>NEW Compact 1U Height Power Entry Module</b> ..... | 134        |
| EBF Series .....  | 138        |
| EC Series .....   | 141        |
| ED Series .....   | 144        |
| EEA & EEB Series .....  | 148        |
| EAS & EBS Models .....  | 148        |
| EAH & EBH Models .....  | 148        |
| EEJ Series .....  | 153        |

**Table of Contents** *(continued)*

|  |                          |
|--|--------------------------|
| EJH & EJHS Models  | .153                     |
| EJM & EJMS Models  | .153                     |
| EJS Models   | .153                     |
| EF Series  | .160                     |
| EJT Series   | .163                     |
| GG & HG Series   | .166                     |
| H Series   | .169                     |
| J Series   | .172                     |
| L Series   | .175                     |
| LA Series  | .180                     |
| M Series   | .183                     |
| P Series   | .192                     |
| SR Series  | .201                     |
| SRB Series   | .203                     |
| <b>4. DC Filters</b>                                     | <b>.209</b>              |
| Introduction   | .210                     |
| Selector Chart   | .211                     |
| DA Series  | .212                     |
| DB Series <b>NEW - Compact RFI High Current DC Inlet</b> | .214                     |
| DC Series  | .217                     |
| P Series   | .223                     |
| <b>5. Feedthrough Filters and Capacitors</b>             | <b>.225</b>              |
| Feedthrough Application Selector Chart                   | .225                     |
| Introduction   | .226                     |
| FFA Series   | .228                     |
| FFD Series   | .231                     |
| AFC Series   | .234                     |
| DFC Series   | .237                     |
| <b>6. Signal Line Products</b>                           | <b>.241</b>              |
| Introduction   | .242                     |
| SignalSentry Filtered Modular Jacks                      | .243                     |
| SignalSentry Part Number Matrix / Ordering Information   | .244                     |
| SignalSentry Selector Chart                              | .245                     |
| L Series   | .247                     |
| L - Ganged Series  | .248                     |
| LC Series  | .249                     |
| LCT Series   | .250                     |
| N Series   | .251                     |
| X Series   | .252                     |
| Z Series   | .253                     |
| Model Dimensions   | .255                     |
| L, LC, LCT and X Series RJ Jack Dimensions               | .255                     |
| N and Z Series RJ Jack Dimensions                        | .257                     |
| <b>7. Technical Notes</b>                                | <b>.261</b>              |
| Introduction   | .262                     |
| Understanding RFI Power Line Filters                     | .263                     |
| Understanding Hipot Testing                              | .266                     |
| Understanding Leakage Current (Touch Current)            | .267                     |
| Understanding Insertion Loss                             | .268                     |
| Appendix A - Conducted RFI Emissions Testing             | .269                     |
| Appendix B - Conducted RFI Susceptibility Testing        | .270                     |
| Appendix C - Health Care Equipment                       | .270                     |
| Appendix D - Safety Agency File Numbers                  | .271                     |
| Part Number Index and Cross Reference                    | .273                     |
| North American Sales Representatives                     | .286                     |
| Authorized Corcom Product Distributors                   | .288                     |
| <b>Worldwide Contacts</b>                                | <b>Inside Back Cover</b> |

---

## Navigating the Catalog

---

### Step 1: Determine the product family.

The Corcom product guide contains seven sections with six distinct product families. Use the index numbers along the side of the catalog to quickly jump to that section.

Corcom Product Families

---

#### RFI Power Line Filters

Solutions associated with EMI/RFI susceptibility as well as compliance to international emissions standards for single phase power applications. Includes chassis and board mountable designs as well as single and two-stage filters.

---

#### Three Phase Filters

Solutions associated with EMI/RFI susceptibility as well as compliance to international emissions standards for three phase and high current applications.

---

#### IEC Inlet and Power Entry Modules

IEC inlet power filters and modular products that address a variety of power entry needs by combining several functions such as on/off switching, voltage selection switching, fuseholder, filtering in combination with the IEC inlet connector.

---

#### DC Power Line Filters

EMI/RFI solutions for emissions and susceptibility specifically related to DC systems often found in central office and telecommunication applications.

---

#### Feedthrough Filters and Capacitors

Products designed for through-bulkhead mounting for high frequency filtering. Designed to meet EN133200 and EN132400 safety requirements. Available in a variety of standard as well as custom configurations.

---

#### Signal Line Products

Products that combine different levels of filtering with various sized RJ modular jacks. Signal line products are used to protect data transmissions as they pass through the RJ jacks or as they are transmitted on the PCB.

---

#### Technical Notes

The appendices in the back of the catalog offer information such as safety agency classifications, general information regarding RFI, and testing procedures.

---

*(continued on next page)*

### Looking for Corcom EMI Facility Products?

Power, data and signal line filters for shielded installations  
Available in Catalog 1654986 - see page 8 for more information

**Navigating the Catalog** *(continued)*

**Step 2: Use selector charts**

Selector charts at the beginning of each section help you to narrow the selection.

Follow the chart to locate one or several product series that could fit your specific application and requirements.

Optimal filter selection requires testing in your specific system, as all systems have unique characteristics.

Selector charts generally show filters in order of performance from good (at the top) to best performance (at the bottom).



**Step 3: Open to the page referenced by the selector chart**

Each product series contains three technical sections. The majority of questions relating to product applications can be answered directly from these sections.

Technical Characteristics: This first section contains pictures, appropriate safety agency classifications, a description of the series' capabilities, applications, electrical specifications, schematics, ordering information and available part numbers.

Drawings: The second section contains drawings and dimensions of the parts as well as the recommended cutouts. Dimensions are shown in inches with metric equivalents.

Performance Data: The third section contains performance data in the form of typical insertion loss graphs and minimum insertion loss tables.

If you already know the catalog number or series, the table of contents lists each series in the catalog within each section. The back of the catalog also has an index in alphanumeric order. The index will reference the technical section for that catalog number or series. The index also provides the unique TE ordering number for each part.

**Step 4: Contact your local Corcom product sales representative**

Corcom product sales representatives for North America as well as distributors and global contacts are listed in the back of the catalog. Contact the sales representative or office closest to you for technical assistance, stock and pricing.

### Corcom EMI/RFI Filters and Energy Efficiency



The efficiency of an electrical device is the ratio of the power it delivers to the power that it consumes. The difference is wasted as heat, and to prevent overheating of a device and the system in which it resides, this heat must be transferred out of the system and dissipated. The efficiency of every component, including the power entry module and selected filter, factors into the system's overall efficiency. When the amount of heat is too great to dissipate through the system's enclosure, forced air cooling becomes necessary. This is often accomplished with a fan, and the power used by that fan, (including its own thermal losses) further decreases the system efficiency by another 2% to 5%. Providing room for the fan and air passageways in the equipment increases its size and cost. Careful attention to the efficiency of every component in the system results in a simpler, smaller, lighter, cooler, more competitive product.

Corcom EMI filters can help meet energy efficiency goals, including Energy Star rating and the new 80 Plus certification, which now recognizes systems that exceed 90% efficiency. By using the most energy efficient design and materials, Corcom filters can be the beginning of an energy efficient system strategy.

Energy efficient power components don't just lower energy bills and demand for power from the grid, they also increase product reliability. Small efficiency increases can decrease component temperatures throughout the system, and semiconductor life doubles for every 10°C decrease in temperature. Corcom filters are more efficient and run cooler, and this can help reduce system warranty costs, service calls and total support costs.

#### Corcom filters

- Have heat dissipation ratings as little as one third that of comparable filters.
- Create less heat and run cooler
- Improve system reliability
- Are more efficient than PC board equivalents
- Can help meet system power efficiency standards
- Enable systems to be smaller and lighter
- Save customers money by reducing energy costs



**Corcom Products Engineering Services and Custom Solutions**

# Corcom Products Engineering Services and Custom Solutions



TE Connectivity Corcom products were established as the world leader in EMI/RFI filtering technology with the introduction of the first line of catalog filter products over 50 years ago.

Today, TE continues to pursue the latest in EMI/RFI filter design by testing and evaluating application specific solutions for a wide range of industries.

In addition to our complete catalog of standard EMI/RFI filtering solutions, TE offers a full range of engineering services and custom products designed for unique applications.

Corcom custom EMI/RFI product solutions can:

- Optimize both cost and performance to target a unique application
- Fit unique mechanical size, installation and/or connection requirements
- Ensure conformance with EMI/RFI requirements of an entire system
- Apply EMI/RFI filtering in a specific frequency or range

With design and testing facilities worldwide, TE is well suited to design an EMI/RFI solution that meets a wide range of unique application needs.

To discuss application specific filtering, contact the TE Corcom product sales representative or office closest to you. A complete list of sales representative and worldwide contacts is listed in the back of this catalog.

**Corcom Custom Filters Key Features:**

- Custom filter options
- Custom wire harness design
- Fully customizable options including packaging
- Agency approvals available as needed by customer
- Time and cost savings to customer
- Simplify installation

**Termination and Wiring Customization Options:**

- Wire length
- Wire gauge
- Wire color
- Molded connectors
- Ring terminals
- Custom terminations



---

**Corcom Engineering Services and Custom Solutions**

---

## EMI/RFI Testing Services

**Corcom Products Test Lab Key Features:**

- We can test product to the FCC / EN / EFT specifications
- Let us know your testing needs and time frame to ensure flexibility of testing and timely results

**Available Testing Standards:**

- Conducted EMI in accordance with FCC part 15 and 18
- EN55011, EN55022 and EN55014
- EFT (Electrically Fast Transient) in accordance with EN61000-4-4
- Tests conducted up to 30A with insertion loss measured up to 10GHz
- MIL-STD-461 CE101 & CE102

An increase in electronic content and stringent regulatory compliance requirements have increased the need for time spent in qualifying test houses. At these “test labs,” products undergo a number of qualifying tests which include conducted emissions, EFT, and harmonic content. Failure to comply with associated standards can lead to delayed time-to-market and product redesign resulting in lost revenue and market share and an increase in time spent at the test lab.

TE Connectivity can help by heading off some of the potential pitfalls during testing and qualifying phases of new products. We offer complimentary testing to existing regulatory standards. We aim for a high standard of accuracy, and can help identify potential problems.

We are not a certifying body and our test lab is not a qualified test lab; however, we test to the same standards and take product through the same rigor as any certifying lab. In addition, our engineers will recommend a solution and help with a design should a product fail to comply with conducted emissions, EFT and/or harmonic content standards.

The advantage is clear: TE will provide you with a high degree of confidence that a product which passed our in-house testing will pass agency testing at a certifying test house in reduced time and with reduced cost.

**TE has three Corcom filter testing facilities:**

- Mundelein, IL, USA (main office and design center)
- West Hills, CA, USA (regional office)
- Ottobrunn, Germany (regional office and design center)



Corcom EMI / RFI Product Solutions for Facility and Heavy Power

# Corcom EMI Facility Products

## Power, data and signal line filters for shielded installations

TE Connectivity has dedicated more than 50 years to developing RFI filter technology for electronic devices. We're proud that our focus on the design and production of the highest quality products has made TE a world leader in RFI technology.

Our leadership in the filter and power entry module markets was enhanced in 1988 with the acquisition of the Heavy Power Line Division of Cornell Dubilier. The high quality designs and manufacturing of these heavy power line filter products is maintained and enhanced by TE.

We have continued that dedication to excellence begun by Cornell Dubilier and inherent to TE's way of doing business. Only the highest quality designs, capacitors, inductors, and workmanship are used to produce these filters. We recognize the need for great care demanded by hi-rel military filters and automatically apply like quality to the heavy power line products. We treat all product as if it is high-reliability.

The Mundelein, IL office provides application engineering service for these heavy power line and military products. Our engineers can help to design a special filter in the rare case a standard product from this catalog cannot adequately solve the problem. Additional product performance data and test results are available from the engineers at this facility.

TE's worldwide sales offices can help you locate information on these products or any of the hundreds of high quality power line filters, power entry modules and SignalSentry products made by TE.

For more information on the complete line of EMI Facility products, request catalog number 1654986 or visit [www.corcom.com](http://www.corcom.com)



**1. RFI Power Line Filters – Table of Contents**

**RFI Power Line Filter Selector Chart . . . . .11**

AQ Series . . . . .12

B Series . . . . .15

DK Series . . . . .18

EBP Series . . . . .21

EDP Series . . . . .21

EOP Series . . . . .21

EMC Series . . . . .24

EP & VP Series . . . . .27

FC Series . . . . .30

FL Series . . . . .33

G Series . . . . .35

HQ Series . . . . .37

HT Series . . . . .40

HZ Series . . . . .43

IK Series . . . . .46

K Series . . . . .49

MV Series . . . . .54

N Series . . . . .56

Q Series . . . . .58

R Series . . . . .61

RK Series . . . . .65

S Series . . . . .68

SB Series . . . . .71

SK Series . . . . .75

T Series . . . . .80

U Series . . . . .84

V Series . . . . .86

W Series . . . . .86

WG Series . . . . .89

X Series . . . . .92

Y Series . . . . .92

Z Series . . . . .92



---

**Engineering Notes**

---



**RFI Power Line Filter Selector Chart**



RFI Power Line Filters



**High Frequency Power Line Filter or Power Entry Module**

# AQ Series



UL Recognized  
CSA Certified



## AQ Series

- Low cost solution to power line noise at high frequencies
- High common and differential mode performance from 10kHz to 1GHz
- Available with an IEC inlet, fuseholder and switch
- Suitable for applications where computers are used to process secret or confidential information

## Ordering Information



## Available Part Numbers

|         |         |
|---------|---------|
| 3VAQ3   | 6VAQ3   |
| 3VAQ8F  | 6VAQ8F  |
| 3VAQ8FS | 6VAQ8FS |

\*IEC 60320-1 C14 inlet mates with C13 connector

## Specifications

### Maximum leakage current each Line to Ground:

|                  | 3A Models | 6A Models |
|------------------|-----------|-----------|
| @ 120 VAC 60 Hz: | 1.2 mA    | .7 mA     |
| @ 250 VAC 50 Hz: | 2.3 mA    | 1.2 mA    |

### Hipot rating (one minute):

|                 |          |
|-----------------|----------|
| Line to Ground: | 2250 VDC |
| Line to Line:   | 1450 VDC |

### Rated Voltage (max):

250 VAC

### Operating Frequency:

50/60 Hz

### Rated Current:

3 or 6A

### Operating Ambient Temperature Range

(at rated current  $I_r$ ): -10°C to +40°C  
In an ambient temperature ( $T_a$ ) higher than +40°C the maximum operating current ( $I_o$ ) is calculated as follows:  $I_o = I_r \sqrt{(85-T_a)/45}$

## Electrical Schematics

### 3A Models



### 6A Models



## Accessories

GA400: NEMA 5-15P to IEC 60320-1 C-13 line cord



High Frequency Power Line Filter or Power Entry Module *(continued)*

# AQ Series

## Case Styles and Dimensions

### 3VAQ3



### 6VAQ3



### 3VAQ8F



### 6VAQ8F



### 3VAQ8FS



### 6VAQ8FS



**High Frequency Power Line Filter or Power Entry Module** *(continued)*

# AQ Series

## Recommended Panel Cutouts



## Performance Data

### Typical Insertion Loss

Measured in closed 50 Ohm system

**3VAQ**



**6VAQ**



— Common Mode / Asymmetrical (L-G)  
- - - Differential Mode / Symmetrical (L-L)

### Minimum Insertion Loss

Measured in closed 50 Ohm system

Common Mode / Asymmetrical (Line to Ground)

| Current Rating | Frequency – MHz |    |    |    |     |     |     |     |      |
|----------------|-----------------|----|----|----|-----|-----|-----|-----|------|
|                | .01             | .1 | .5 | 1  | 10  | 50  | 100 | 300 | 1000 |
| 3A             | 10              | 80 | 88 | 88 | 100 | 100 | 100 | 93  | 85   |
| 6A             | 26              | 59 | 80 | 80 | 100 | 100 | 100 | 93  | 85   |

Differential Mode / Symmetrical (Line to Line)

| Current Rating | Frequency – MHz |    |    |    |     |     |     |     |      |
|----------------|-----------------|----|----|----|-----|-----|-----|-----|------|
|                | .01             | .1 | .5 | 1  | 10  | 50  | 100 | 300 | 1000 |
| 3A             | 6               | 51 | 78 | 88 | 100 | 100 | 100 | 93  | 85   |
| 6A             | 10              | 65 | 86 | 95 | 100 | 100 | 100 | 93  | 85   |



**General Purpose RFI Filters for High Impedance Loads at Low Current**

# B Series



UL Recognized  
CSA Certified  
VDE Approved



## B Series

- Small size & low cost
- General purpose
- Wide variety of termination options
- Meets low leakage current requirements of VDE portable equipment and non-patient medical equipment

## Ordering Information



## Electrical Schematic



## Specifications

**Maximum leakage current each Line to Ground:**

|                  | VB Models | EB Models |
|------------------|-----------|-----------|
| @ 120 VAC 60 Hz: | .4 mA     | .21 mA    |
| @ 250 VAC 50 Hz: | .7 mA     | .36 mA    |

**Hipot rating (one minute):**

|                 |          |
|-----------------|----------|
| Line to Ground: | 2250 VDC |
| Line to Line:   | 1450 VDC |

**Rated Voltage (max):** 250 VAC

**Operating Frequency:** 50/60 Hz

**Rated Current:** 1 to 30A

**Operating Ambient Temperature Range**

(at rated current  $I_r$ ): -10°C to +40°C  
In an ambient temperature ( $T_a$ ) higher than +40°C the maximum operating current ( $I_o$ ) is calculated as follows:  $I_o = I_r \sqrt{(85-T_a)/45}$

## Available Part Numbers

|       |       |
|-------|-------|
| 1VB1  | 1EB1  |
| 1VB3  | 1EB3  |
| 2VB1  | 2EB1  |
| 2VB3  | 2EB3  |
| 3VB1  | 3EB1  |
| 3VB3  | 3EB3  |
| 5VB1  | 5EB1  |
| 5VB3  | 5EB3  |
| 10VB1 | 10EB1 |
| 10VB3 | 10EB3 |
| 10VB6 | 20EB1 |
| 20VB1 |       |
| 20VB6 |       |
| 30VB6 |       |

**General Purpose RFI Filters for High Impedance/ Low Current** *(continued)*

# B Series

## Case Styles

### B1



Typical Dimensions:  
 Line/Load Terminals (4): .250 [6.3] with .07 [1.8] Dia. hole  
 Ground Terminal (1): .250 [6.3] with .07 x .16 [1.8 x 3.8] slot  
 Mounting Holes (2): .188 [4.75] Dia.

### 30VB6



Typical Dimensions:  
 Terminals (5): 8-32, Torque 18 lbf-in. [2.03 N-m] max. ± 2 [2.2]  
 Mounting Slots (4): .250 x .156 [6.35 x 3.96]

### B3



Typical Dimensions:  
 Wire leads (5): 4.0 [101.6] Min. AWG18, (AWG16 for 10A)  
 Mounting Holes (2): .188 [4.75] Dia.

### 10VB6 & 20VB6



Typical Dimensions:  
 Terminals (5): 8-32, Torque 18 lbf-in. [2.03 N-m] max. ± 2 [2.2]  
 Mounting Holes (4): .188 [4.75] Dia.

## Case Dimensions

| Part No.     | A<br>(max)  | B<br>(max)  | C<br>(max)  | D<br>$\pm .015$<br>$\pm .38$ | E<br>(max)  |
|--------------|-------------|-------------|-------------|------------------------------|-------------|
| 1VB1, 1EB1,  | <b>2.25</b> | <b>1.82</b> | <b>0.66</b> | <b>2.125</b>                 | <b>2.53</b> |
| 2VB1, 2EB1   | 57.2        | 46.2        | 16.8        | 53.98                        | 64.3        |
| 1VB3, 1EB3,  | <b>0.96</b> | <b>1.82</b> | <b>0.66</b> | <b>2.125</b>                 | <b>2.53</b> |
| 2VB3, 2EB3   | 24.4        | 46.2        | 16.8        | 53.98                        | 64.3        |
| 3VB1, 3EB1,  | <b>2.61</b> | <b>1.82</b> | <b>0.78</b> | <b>2.125</b>                 | <b>2.53</b> |
| 5VB1, 5EB1   | 66.3        | 46.2        | 193.8       | 53.98                        | 64.3        |
| 3VB3, 3EB3,  | <b>1.32</b> | <b>1.82</b> | <b>0.78</b> | <b>2.125</b>                 | <b>2.53</b> |
| 5VB3, 5EB3   | 33.5        | 46.2        | 19.8        | 53.98                        | 64.3        |
| 10VB1, 10EB1 | <b>2.61</b> | <b>1.82</b> | <b>1.16</b> | <b>2.125</b>                 | <b>2.53</b> |
|              | 66.3        | 46.2        | 29.5        | 53.98                        | 6.3         |
| 10VB3, 10EB3 | <b>1.32</b> | <b>1.82</b> | <b>1.16</b> | <b>2.125</b>                 | <b>2.53</b> |
|              | 33.5        | 46.2        | 29.5        | 53.98                        | 64.3        |
| 10VB6        | <b>2.72</b> | <b>1.82</b> | <b>1.16</b> | <b>2.125</b>                 | <b>2.53</b> |
|              | 69.1        | 46.2        | 29.5        | 53.98                        | 64.3        |
| 20VB1, 20EB1 | <b>3.36</b> | <b>2.07</b> | <b>1.16</b> | <b>2.375</b>                 | <b>2.81</b> |
|              | 85.3        | 52.6        | 29.5        | 60.33                        | 71.4        |
| 20VB6        | <b>3.46</b> | <b>2.07</b> | <b>1.16</b> | <b>2.375</b>                 | <b>2.81</b> |
|              | 87.9        | 52.6        | 29.5        | 60.33                        | 71.4        |
| 30VB6        | <b>5.34</b> | <b>3.38</b> | <b>1.53</b> | <b>3.75</b>                  | <b>4.20</b> |
|              | 135.6       | 85.9        | 38.9        | 95.3                         | 106.7       |

**General Purpose RFI Filters for High Impedance/ Low Current** *(continued)*

# B Series

## Performance Data

### Typical Insertion Loss

Measured in closed 50 Ohm system

— Common Mode / Asymmetrical (L-G)  
— Differential Mode / Symmetrical (L-L)

**1EB & 3EB**



**2EB, 5EB & 10EB**



**20EB**



**1VB**



**2VB**



**3VB**



**10VB**



**20VB**



**30VB**



## Minimum Insertion Loss

Measured in closed 50 Ohm system

Common Mode / Asymmetrical (Line to Ground)

| Current Rating        | Frequency – MHz |    |    |    |    |    |
|-----------------------|-----------------|----|----|----|----|----|
|                       | .15             | .5 | 1  | 5  | 10 | 30 |
| <b>VB Models</b>      |                 |    |    |    |    |    |
| 1A, 3A                | 15              | 30 | 38 | 50 | 50 | 50 |
| 2A, 5A, 10A, 20A, 30A | 7               | 20 | 25 | 40 | 45 | 48 |
| <b>EB Models</b>      |                 |    |    |    |    |    |
| 1A, 3A                | 15              | 29 | 35 | 45 | 45 | 48 |
| 2A, 5A, 10A, 20A      | 7               | 19 | 23 | 34 | 37 | 42 |

**Enhanced Differential Mode Performance K Series RFI Line Filters**

# DK Series



UL Recognized  
CSA Certified  
VDE Approved



## DK Series

- Higher performance Line to Line attenuation than the K Series
- E version meets the low leakage current requirements of VDE portable equipment and non-patient care equipment
- V version features same high performance with more cost-effective design

## Ordering Information

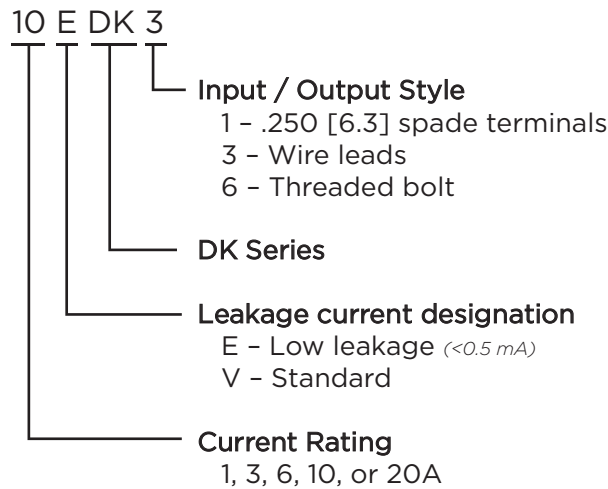

## Electrical Schematic



## Specifications

### Maximum leakage current each Line to Ground:

|                  | VDK Models | EDK Models |
|------------------|------------|------------|
| @ 120 VAC 60 Hz: | .4 mA      | .22 mA     |
| @ 250 VAC 50 Hz: | .7 mA      | .38 mA     |

### Hipot rating (one minute):

|                 |          |
|-----------------|----------|
| Line to Ground: | 2250 VDC |
| Line to Line:   | 1450 VDC |

### Rated Voltage (max):

250 VAC

### Operating Frequency:

50/60 Hz

### Rated Current:

1 to 20A

### Operating Ambient Temperature Range

(at rated current  $I_r$ ): -10°C to +40°C  
In an ambient temperature ( $T_a$ ) higher than +40°C the maximum operating current ( $I_o$ ) is calculated as follows:  $I_o = I_r \sqrt{(85-T_a)/45}$

## Available Part Numbers

|        |        |
|--------|--------|
| 1VVK1  | 1EDK1  |
| 1VVK3  | 1EDK3  |
| 3VVK1  | 3EDK1  |
| 3VVK3  | 3EDK3  |
| 6VVK1  | 6EDK1  |
| 6VVK3  | 6EDK3  |
| 10VVK1 | 10EDK1 |
| 10VVK3 | 10EDK3 |
| 20VVK1 | 20EDK1 |
| 20VVK6 |        |

**Enhanced Differential Mode K Series RFI Power Line Filters** *(continued)*

# DK Series

## Case Styles

### VDK1 / EDK1



Typical Dimensions:  
 Line/Load Terminals (4): .250 [6.3] with .07 [1.8] Dia. hole  
 Ground Terminal (1): .250 [6.3] with .07 x .16 [1.8 x 3.8] slot  
 Mounting Holes (2): .188 [4.75] Dia.

### VDK3 / EDK3



Typical Dimensions:  
 Wire leads (5): 4.0 [101.6] Min., AWG18 (AWG16 for 10A)  
 Mounting Holes (2): .188 [4.75] Dia.

### 20VDK1 / 20EDK1



Typical Dimensions:  
 Line/Load Terminals (4): .250 [6.3] with .07 [1.8] Dia. hole  
 Ground Terminal (1): .250 [6.3] with .07 x .16 [1.8 x 3.8] slot  
 Mounting Holes (4): .188 [4.75] Dia.

### 20VDK6



Typical Dimensions:  
 Terminals (5): 8-32, Torque 18 lbf-in. [2.03 N-m] max. ± 2 [22]  
 Mounting Holes (2): .188 [4.75] Dia.

## Case Dimensions

| Part No.                      | A<br>(max)          | B<br>(max)          | C<br>(max)          | D<br>$\pm .015$<br>$\pm .38$ | E<br>(max)          |
|-------------------------------|---------------------|---------------------|---------------------|------------------------------|---------------------|
| 1VDK1, 1EDK1                  | <b>3.35</b><br>85.1 | <b>2.07</b><br>52.6 | <b>1.16</b><br>29.5 | <b>2.375</b><br>60.33        | <b>2.81</b><br>71.4 |
| 1VDK3, 1EDK3                  | <b>2.07</b><br>52.6 | <b>2.07</b><br>52.6 | <b>1.16</b><br>29.5 | <b>2.375</b><br>60.33        | <b>2.81</b><br>71.4 |
| 3VDK1, 3EDK1,<br>6VDK1, 6EDK1 | <b>3.85</b><br>97.8 | <b>2.07</b><br>52.6 | <b>1.16</b><br>29.5 | <b>2.938</b><br>74.63        | <b>3.35</b><br>85.1 |
| 3VDK3, 3EDK3,<br>6VDK3, 6EDK3 | <b>2.56</b><br>65.0 | <b>2.07</b><br>52.6 | <b>1.16</b><br>29.5 | <b>2.938</b><br>74.63        | <b>3.35</b><br>85.1 |
| 10VDK1,<br>10EDK1             | <b>3.85</b><br>97.8 | <b>2.07</b><br>52.6 | <b>1.32</b><br>33.5 | <b>2.938</b><br>74.63        | <b>3.35</b><br>85.1 |
| 10VDK3,<br>10EDK3             | <b>2.57</b><br>65.3 | <b>2.07</b><br>52.6 | <b>1.32</b><br>33.5 | <b>2.938</b><br>74.63        | <b>3.35</b><br>85.1 |
| 20VDK1,<br>20EDK1             | <b>3.85</b><br>97.8 | <b>2.58</b><br>65.5 | <b>1.78</b><br>45.2 | <b>2.938</b><br>74.63        | <b>3.35</b><br>85.1 |
| 20VDK6                        | <b>3.46</b><br>87.9 | <b>2.58</b><br>65.5 | <b>1.78</b><br>45.2 | <b>2.938</b><br>74.63        | <b>3.35</b><br>85.1 |

**Enhanced Differential Mode K Series RFI Power Line Filters** *(continued)*

# DK Series

## Performance Data

### Typical Insertion Loss

Measured in closed 50 Ohm system

**1 & 3VDK**



**6, 10, 20VDK**

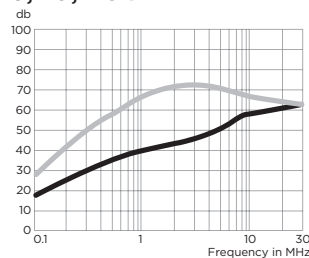

**1 & 3EDK**



**6, 10, 20EDK**



— Common Mode / Asymmetrical (L-G)  
— Differential Mode / Symmetrical (L-L)

### Minimum Insertion Loss

Measured in closed 50 Ohm system

Common Mode / Asymmetrical (Line to Ground)

| Current Rating    | Frequency – MHz |    |    |    |    |    |
|-------------------|-----------------|----|----|----|----|----|
|                   | .15             | .5 | 1  | 5  | 10 | 30 |
| <b>VDK Models</b> |                 |    |    |    |    |    |
| 1A, 3A            | 18              | 30 | 40 | 48 | 48 | 40 |
| 6A, 10A, 20A      | 10              | 22 | 30 | 39 | 44 | 50 |
| <b>EDK Models</b> |                 |    |    |    |    |    |
| 1A, 3A            | 17              | 27 | 33 | 45 | 45 | 40 |
| 6A, 10A, 20A      | 10              | 19 | 25 | 34 | 40 | 46 |

Differential Mode / Symmetrical (Line to Line)

| Current Rating              | Frequency – MHz |    |    |    |    |    |
|-----------------------------|-----------------|----|----|----|----|----|
|                             | .15             | .5 | 1  | 5  | 10 | 30 |
| <b>VDK &amp; EDK Models</b> |                 |    |    |    |    |    |
| 1A, 3A                      | 18              | 47 | 62 | 60 | 50 | 45 |
| 6A, 10A, 20A                | 20              | 43 | 55 | 65 | 60 | 55 |

PC Board Mountable General Purpose RFI Filters

# EBP, EDP & EOP Series



UL Recognized\*  
CSA Certified\*  
VDE Approved\*



## EBP Series

- General purpose
- Low leakage current
- Cost-effective
- Compact size

## EDP Series

- Enhanced differential mode performance
- Low leakage current
- Cost-effective

## EOP Series

- General purpose
- Low leakage current
- Cost-effective

## Ordering Information



\*EBP models are approved to VDE standards only

## Specifications

Maximum leakage current each Line to Ground:

|                  | EDP/EOP | EBP    |
|------------------|---------|--------|
| @ 120 VAC 60 Hz: | .22 mA  | .13 mA |
| @ 250 VAC 50 Hz: | .38 mA  | .21 mA |

Hipot rating (one minute):

|                 |          |
|-----------------|----------|
| Line to Ground: | 2250 VDC |
| Line to Line:   | 1450 VDC |

Rated Voltage (max):

250 VAC

Operating Frequency:

50/60 Hz

Rated Current:

1 to 10A

Operating Ambient Temperature Range

(at rated current  $I_r$ ): -10°C to +40°C  
In an ambient temperature ( $T_a$ ) higher than +40°C the maximum operating current ( $I_o$ ) is calculated as follows:  $I_o = I_r \sqrt{(85-T_a)/45}$

## Electrical Schematic

### EBP



### EDP & EOP



## Available Part Numbers

|       |       |
|-------|-------|
| 1EBP  | 3EBP  |
| 1EDP  | 1EOP  |
| 3EDP  | 3EOP  |
| 6EDP  | 6EOP  |
| 10EDP | 10EOP |

1  
RFI Power Line Filters

PC Board Mountable General Purpose RFI Filters (continued)

# EBP, EDP, EOP Series

## Case Styles

### EBP



Typical Dimensions:  
Pins (5): 0.025 [0.635] square

### EDP / EOP



Typical Dimensions:  
Pins (5): 0.025 [0.635] square

## Case Dimensions

| Part No. | A<br>(max)   | B<br>(max)   | C<br>(max)    |
|----------|--------------|--------------|---------------|
| EBP      | .984<br>25.0 | .984<br>25.0 | .984<br>25.0  |
| EDP      | 1.44<br>36.6 | 1.24<br>31.5 | 0.95<br>24.15 |
| EOP      | 1.44<br>36.6 | 1.24<br>31.5 | 0.78<br>19.9  |

## Performance Data

### Typical Insertion Loss

Measured in closed 50 Ohm system

1EBP



3EBP



— Common Mode / Asymmetrical (L-G)  
- - - Differential Mode / Symmetrical (L-L)



PC Board Mountable General Purpose RFI Filters (continued)

# EBP, EDP & EOP Series

## Performance Data (continued)

### Typical Insertion Loss

Measured in closed 50 Ohm system

— Common Mode / Asymmetrical (L-G)  
— Differential Mode / Symmetrical (L-L)

1EDP



3EDP



6EDP



10EDP



1EOP



3EOP



6EOP



10EOP



### Minimum Insertion Loss

Measured in closed 50 Ohm system

Common Mode / Asymmetrical (Line to Ground)

| Current Rating    | Frequency – MHz |    |    |    |    |    |
|-------------------|-----------------|----|----|----|----|----|
|                   | .15             | .5 | 1  | 5  | 10 | 30 |
| <b>EBP Models</b> |                 |    |    |    |    |    |
| 1A                | 30              | 40 | 40 | 42 | 45 | 45 |
| 3A                | 24              | 29 | 30 | 42 | 45 | 45 |
| <b>EOP Models</b> |                 |    |    |    |    |    |
| 1A                | 32              | 41 | 54 | 54 | 46 | 40 |
| 3A                | 18              | 28 | 35 | 41 | 40 | 40 |
| 6A                | 10              | 20 | 28 | 37 | 40 | 40 |
| 10A               | 5               | 14 | 19 | 27 | 33 | 40 |
| <b>EDP Models</b> |                 |    |    |    |    |    |
| 1A                | 32              | 41 | 54 | 54 | 46 | 40 |
| 3A                | 18              | 28 | 35 | 41 | 40 | 40 |
| 6A                | 10              | 20 | 28 | 37 | 40 | 40 |
| 10A               | 5               | 14 | 19 | 27 | 33 | 40 |

Differential Mode / Symmetrical (Line to Line)

| Current Rating    | Frequency – MHz |    |    |    |    |    |    |    |
|-------------------|-----------------|----|----|----|----|----|----|----|
|                   | .15             | .5 | 1  | 5  | 10 | 30 |    |    |
| <b>EBP Models</b> |                 |    |    |    |    |    |    |    |
| 1A                | -               | 14 | 25 | 35 | 33 | 25 |    |    |
| 3A                | -               | 14 | 15 | 31 | 34 | 25 |    |    |
| <b>EOP Models</b> |                 |    |    |    |    |    |    |    |
| 1A                | 4               | 14 | 42 | 42 | 44 | 38 |    |    |
| 3A                | 4               | 14 | 24 | 38 | 38 | 38 |    |    |
| 6A                | 4               | 14 | 22 | 30 | 34 | 34 |    |    |
| 10A               | 6               | 16 | 22 | 40 | 50 | 45 |    |    |
| <b>EDP Models</b> |                 |    |    |    |    |    |    |    |
|                   | Frequency – MHz |    |    |    |    |    |    |    |
|                   | .15             | .5 | 1  | 2  | 4  | 10 | 20 | 30 |
| 1A                | 1               | 6  | 19 | 39 | 48 | 52 | 38 | 35 |
| 3A                | 1               | 4  | 9  | 9  | 28 | 41 | 36 | 35 |
| 6A                | 1               | 4  | 9  | 9  | 40 | 40 | 42 | 35 |
| 10A               | 1               | 4  | 9  | 9  | 14 | 35 | 42 | 35 |

**Compact and Cost-effective Dual Stage RFI Power Line Filters**

# EMC Series



UL Recognized  
CSA Certified  
VDE Approved



EMC6



EMC1

## EMC Series

- Compact dual stage filter series
- Cost-effective design
- Current rating up to 30A
- High differential mode attenuation in the lower frequency range
- High common mode performance
- Suitable for switching mode power supplies

## Ordering Information



## Specifications

**Maximum leakage current each Line to Ground:**

|                  |                  |                    |
|------------------|------------------|--------------------|
|                  | <i>3, 6, 10A</i> | <i>15, 20, 30A</i> |
| @ 120 VAC 60 Hz: | .21 mA           | .73 mA             |
| @ 250 VAC 50 Hz: | .43 mA           | 1.52 mA            |

**Hipot rating (one minute):**

|                 |          |
|-----------------|----------|
| Line to Ground: | 2250 VDC |
| Line to Line:   | 1450 VDC |

**Rated Voltage (max):**

250 VAC

**Operating Frequency:**

50/60 Hz

**Rated Current:**

3 to 30A

**Operating Ambient Temperature Range**

(at rated current  $I_r$ ): -10°C to +40°C  
In an ambient temperature ( $T_a$ ) higher than +40°C the maximum operating current ( $I_o$ ) is calculated as follows:  $I_o = I_r \sqrt{(85-T_a)/45}$

## Electrical Schematic



## Available Part Numbers

|        |        |
|--------|--------|
| 3EMC1  | 10EMC3 |
| 6EMC1  | 15EMC3 |
| 10EMC1 | 10EMC6 |
| 15EMC1 | 15EMC6 |
| 20EMC1 | 20EMC6 |
| 3EMC3  | 30EMC6 |
| 6EMC3  |        |

**Compact and Cost-effective Dual Stage RFI Power Line Filters** *(continued)*

# EMC Series

## Case Styles

### EMC1

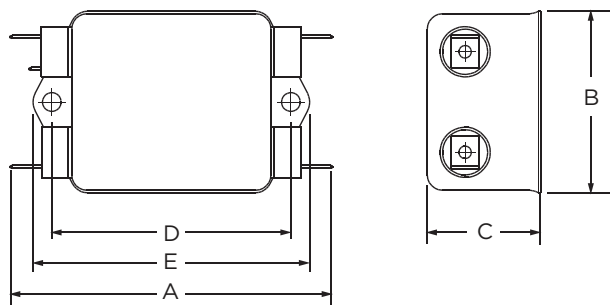

Typical Dimensions:  
 Line/Load Terminals (4): .250 [6.3] with .07 [1.8] Dia. hole  
 Ground Terminal (1): .250 [6.3] with .07 x .16 [1.8 x 3.8] slot  
 Mounting Holes (2): .187 ±.008 [4.75 ±.20] Dia.

### 30EMC6

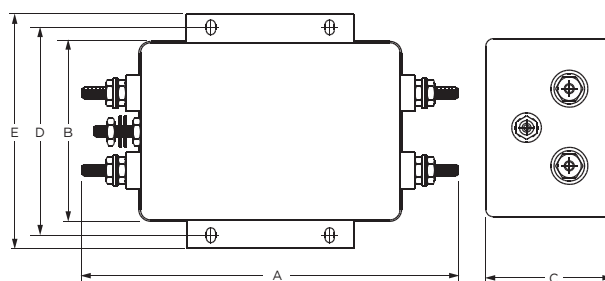

Typical Dimensions:  
 Terminals (5): 10-32, Torque 27 lbf-in. [3.05 N-m] max. ± 3 [.34]  
 Mounting Slots (4): .203 x .156 [5.16 x 3.96]

### EMC3

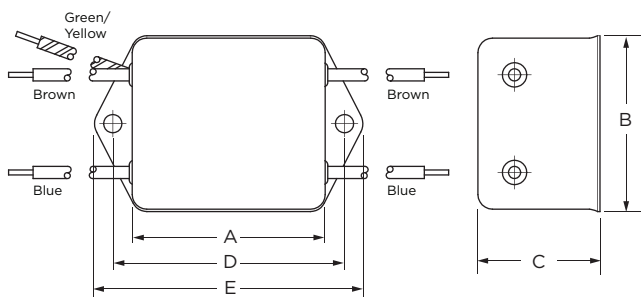

Typical Dimensions:  
 Wire leads (5): 4.0 [101.6] Min., AWG18 (AWG16 for 15A)  
 Mounting Holes (2): .187 ±.008 [4.75 ±.20] Dia.

### EMC6

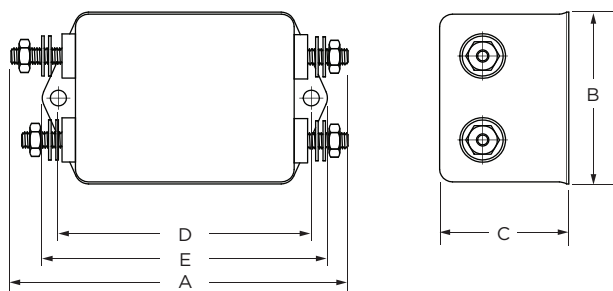

Typical Dimensions:  
 Terminals (5): 8-32, Torque 18 lbf-in. [2.03 N-m] max. ± 2 [.22]  
 Mounting Holes (4): .187 ±.008 [4.75 ±.20] Dia.

## Case Dimensions

| Part No. | A<br>(max)                  | B<br>(max)                 | C<br>(max)                  | D<br>(max)                   | E<br>(max)                  |
|----------|-----------------------------|----------------------------|-----------------------------|------------------------------|-----------------------------|
| 3EMC1    | <b>3.35</b><br><i>85.1</i>  | <b>1.81</b><br><i>46</i>   | <b>1.16</b><br><i>29.5</i>  | <b>2.375</b><br><i>60.3</i>  | <b>2.78</b><br><i>70.6</i>  |
| 6EMC1    | <b>3.85</b><br><i>97.8</i>  | <b>2.07</b><br><i>52.6</i> | <b>1.16</b><br><i>29.5</i>  | <b>2.938</b><br><i>74.6</i>  | <b>3.35</b><br><i>85.1</i>  |
| 10EMC1   | <b>3.85</b><br><i>97.8</i>  | <b>2.07</b><br><i>52.6</i> | <b>1.53</b><br><i>38.91</i> | <b>2.938</b><br><i>74.6</i>  | <b>3.35</b><br><i>85.1</i>  |
| 15EMC1   | <b>4.97</b><br><i>126.2</i> | <b>2.25</b><br><i>57.2</i> | <b>1.78</b><br><i>45.2</i>  | <b>4.063</b><br><i>103.2</i> | <b>4.46</b><br><i>113.3</i> |
| 20EMC1   | <b>4.97</b><br><i>126.2</i> | <b>2.25</b><br><i>57.2</i> | <b>1.78</b><br><i>45.2</i>  | <b>4.063</b><br><i>103.2</i> | <b>4.46</b><br><i>113.3</i> |
| 3EMC3    | <b>2.07</b><br><i>52.6</i>  | <b>1.81</b><br><i>46</i>   | <b>1.16</b><br><i>29.5</i>  | <b>2.375</b><br><i>60.3</i>  | <b>2.78</b><br><i>70.6</i>  |
| 6EMC3    | <b>2.56</b><br><i>65</i>    | <b>2.07</b><br><i>52.6</i> | <b>1.16</b><br><i>29.5</i>  | <b>2.938</b><br><i>74.6</i>  | <b>3.35</b><br><i>85.1</i>  |
| 10EMC3   | <b>2.56</b><br><i>65</i>    | <b>2.07</b><br><i>52.6</i> | <b>1.53</b><br><i>38.9</i>  | <b>2.938</b><br><i>74.6</i>  | <b>3.35</b><br><i>85.1</i>  |
| 15EMC3   | <b>3.69</b><br><i>93.7</i>  | <b>2.25</b><br><i>57.2</i> | <b>1.78</b><br><i>45.2</i>  | <b>4.063</b><br><i>103.2</i> | <b>4.47</b><br><i>113.5</i> |
| 10EMC6   | <b>3.94</b><br><i>99.9</i>  | <b>2.07</b><br><i>52.6</i> | <b>1.53</b><br><i>38.9</i>  | <b>2.938</b><br><i>74.6</i>  | <b>3.35</b><br><i>85.1</i>  |
| 15EMC6   | <b>5.09</b><br><i>129.3</i> | <b>2.25</b><br><i>57.2</i> | <b>1.78</b><br><i>45.2</i>  | <b>4.063</b><br><i>103.2</i> | <b>4.47</b><br><i>113.5</i> |
| 20EMC6   | <b>5.09</b><br><i>129.3</i> | <b>2.25</b><br><i>57.2</i> | <b>1.78</b><br><i>45.2</i>  | <b>4.063</b><br><i>103.2</i> | <b>4.47</b><br><i>113.5</i> |
| 30EMC6   | <b>6.05</b><br><i>153.7</i> | <b>3.12</b><br><i>79.2</i> | <b>2.18</b><br><i>55.4</i>  | <b>3.5</b><br><i>88.9</i>    | <b>3.96</b><br><i>100.6</i> |

**Compact and Cost-effective Dual Stage RFI Power Line Filters** *(continued)*

# EMC Series

## Performance Data

### Typical Insertion Loss

Measured in closed 50 Ohm system

**3EMC**



**6EMC**



**10EMC**



**15EMC**



**20EMC**



**30EMC**



— Common Mode / Asymmetrical (L-G)  
— Differential Mode / Symmetrical (L-L)

### Minimum Insertion Loss

Common Mode / Asymmetrical (Line to Ground)

| Current Rating | Frequency – MHz |     |     |     |    |    |    |    |    |
|----------------|-----------------|-----|-----|-----|----|----|----|----|----|
|                | .05             | .07 | .11 | .15 | 1  | 2  | 10 | 20 | 30 |
| 3A             | 6               | 6   | 3   | 16  | 65 | 66 | 62 | 60 | 59 |
| 6A             | 6               | 6   | 2   | 15  | 65 | 67 | 65 | 62 | 63 |
| 10A            | 5               | 2   | 13  | 24  | 72 | 72 | 56 | 50 | 48 |
| 15A            | 3               | 1   | 12  | 22  | 70 | 68 | 57 | 54 | 53 |
| 20A            | 2               | 2   | 11  | 21  | 58 | 57 | 63 | 55 | 52 |
| 30A            | 2               | 2   | 14  | 22  | 47 | 52 | 60 | 48 | 43 |

Differential Mode / Symmetrical (Line to Line)

| Current Rating | Frequency – MHz |     |     |     |    |    |    |    |    |
|----------------|-----------------|-----|-----|-----|----|----|----|----|----|
|                | .05             | .07 | .11 | .15 | 1  | 2  | 10 | 20 | 30 |
| 3A             | 12              | 13  | 7   | 18  | 64 | 69 | 65 | 60 | 52 |
| 6A             | 12              | 12  | 8   | 27  | 61 | 61 | 59 | 56 | 54 |
| 10A            | 14              | 15  | 12  | 33  | 54 | 58 | 47 | 34 | 36 |
| 15A            | 16              | 16  | 13  | 34  | 61 | 52 | 36 | 36 | 23 |
| 20A            | 17              | 19  | 15  | 37  | 67 | 62 | 36 | 32 | 30 |
| 30A            | 17              | 18  | 14  | 40  | 62 | 53 | 30 | 28 | 26 |

Dual Stage RFI Power Line Filters for Switching Mode Power Supplies

# EP / VP Series



UL Recognized  
CSA Certified  
VDE Approved



## EP & VP Series

- Dual stage filter offers high insertion loss
- Well suited for meeting CISPR 22 A and FCC Part 15J, Class B
- EP model meets very low leakage current requirements
- 7A and 12A versions offer optimum package size

## Ordering Information



## Electrical Schematic



\*IEC 60320-1 C14 inlet mates with C13 connector

## Specifications

### Maximum leakage current each Line to Ground:

|                  | VP Models | EP Models |
|------------------|-----------|-----------|
| @ 120 VAC 60 Hz: | .73 mA    | .21 mA    |
| @ 250 VAC 50 Hz: | 1.27 mA   | .36 mA    |

### Hipot rating (one minute):

|                 |          |
|-----------------|----------|
| Line to Ground: | 2250 VDC |
| Line to Line:   | 1450 VDC |

### Rated Voltage (max):

250 VAC

### Operating Frequency:

50/60 Hz

### Rated Current:

3 to 20A

### Operating Ambient Temperature Range

(at rated current  $I_r$ ): -10°C to +40°C  
In an ambient temperature ( $T_a$ ) higher than +40°C the maximum operating current ( $I_o$ ) is calculated as follows:  $I_o = I_r \sqrt{(85-T_a)/45}$

## Available Part Numbers

|       |       |
|-------|-------|
| 3EP1  | 10EP1 |
| 3EP3  | 10EP3 |
| 3EP7  | 12EP1 |
| 3EP7M | 12EP3 |
| 6EP1  | 20EP1 |
| 6EP3  | 20EP6 |
| 7EP1  | 20VP1 |
| 7EP3  | 20VP6 |

## Accessories

GA400: NEMA 5-15P to IEC 60320-1 C-13 line cord



Dual Stage RFI Filters for Switching Power Supplies *(continued)*

# EP / VP Series

## Case Styles

### EP1 / VP1 (1-15A)



Typical Dimensions:  
 Line/Load Terminals (4): .250 [6.3] with .07 [1.8] Dia. hole  
 Ground Terminal (1): .250 [6.3] with .07 x .16 [1.8 x 3.8] slot  
 Mounting Holes (2): .188 [4.78] Dia.

### EP7 & EP7M



Typical Dimensions:  
 Load Terminals (2): .250 [6.3] with .07 [1.8] Dia. hole  
 Line Inlet (1): IEC 60320-1 C14  
 EP7 Tapped Inserts (2): 6-32 x 1/4  
 EP7M Tapped Inserts (2): M3 x .5

### 20EP1 / VP1



Typical Dimensions:  
 Line/Load Terminals (4): .250 [6.3] with .07 [1.8] Dia. hole  
 Ground Terminal (1): .250 [6.3] with .07 x .16 [1.8 x 3.8] slot  
 Mounting Holes (2): .188 [4.78] Dia.

### 20EP6 / VP6



Typical Dimensions:  
 Terminals (5): 8-32, Torque 18 lbf-in. [2.03 N-m] max. ± 2 [22]  
 Mounting Holes (2): .188 [4.78] Dia.

### EP3



Typical Dimensions:  
 Wire leads (5): 4.0 [101.6] Min, AWG18  
 Mounting Holes (2): .188 [4.78] Dia.

## Recommended Panel Cutout



Tolerance ± .005 [0.13]

Dual Stage RFI Filters for Switching Power Supplies *(continued)*

# EP / VP Series

## Case Dimensions

| Part No.  | A<br>(max) | B<br>(max) | C<br>(max) | D<br>$\pm .015$<br>$\pm .38$ | E<br>(max) |
|-----------|------------|------------|------------|------------------------------|------------|
| 3EP1      | 3.85       | 2.07       | 1.78       | 2.938                        | 3.35       |
| 3EP3      | 2.56       | 2.07       | 1.78       | 2.938                        | 3.35       |
| 3EP7/7M   | 3.21       | 2.25       | 1.78       | 1.575                        | 0.63*      |
| 6EP1      | 6.62       | 2.07       | 2.28       | 5.625                        | 6.03       |
| 6EP3      | 5.33       | 2.07       | 2.28       | 5.625                        | 6.03       |
| 7EP1      | 4.79       | 2.07       | 1.53       | 3.947                        | 4.33       |
| 7EP3      | 3.50       | 2.07       | 1.53       | 3.947                        | 4.33       |
| 10EP1     | 6.62       | 2.07       | 2.78       | 5.625                        | 6.03       |
| 10EP3     | 5.35       | 2.03       | 2.78       | 5.625                        | 6.03       |
| 12EP1     | 4.97       | 1.78       | 1.78       | 4.063                        | 4.46       |
| 12EP3     | 3.624      | 1.78       | 1.78       | 4.063                        | 4.46       |
| 20EP1/VP1 | 4.95       | 1.8        | 1.8        | 4.063                        | 4.47       |
| 20EP6/VP6 | 5.09       | 1.78       | 1.78       | 4.063                        | 4.46       |

\*±0.02 [0.5]

## Performance Data

### Typical Insertion Loss

Measured in closed 50 Ohm system

#### 3EP



#### 6EP



#### 7EP



#### 10EP



## Typical Insertion Loss *(continued)*

#### 12EP



#### 20EP



#### 20VP

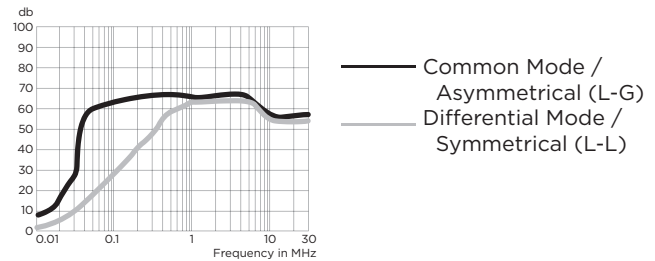

## Minimum Insertion Loss

Measured in closed 50 Ohm system

Common Mode / Asymmetrical (Line to Ground)

| Current Rating   | Frequency – MHz |     |     |    |    |    |    |    |
|------------------|-----------------|-----|-----|----|----|----|----|----|
|                  | .01             | .05 | .15 | .5 | 1  | 5  | 10 | 30 |
| <b>EP Models</b> |                 |     |     |    |    |    |    |    |
| 3A               | 12              | 10  | 58  | 65 | 65 | 66 | 62 | 30 |
| 6, 10A           | 10              | 15  | 60  | 65 | 65 | 65 | 60 | 35 |
| 7A               | 15              | 28  | 63  | 75 | 78 | 75 | 75 | 55 |
| 12A              | 12              | 7   | 52  | 68 | 70 | 70 | 70 | 45 |
| 20A              | 3               | 6   | 28  | 50 | 55 | 60 | 55 | 55 |

#### VP Models

|     |   |   |    |    |    |    |    |    |
|-----|---|---|----|----|----|----|----|----|
| 20A | 3 | 2 | 42 | 60 | 65 | 65 | 55 | 55 |
|-----|---|---|----|----|----|----|----|----|

Differential Mode / Symmetrical (Line to Line)

| Current Rating   | Frequency – MHz |     |     |    |    |    |    |    |
|------------------|-----------------|-----|-----|----|----|----|----|----|
|                  | .01             | .05 | .15 | .5 | 1  | 5  | 10 | 30 |
| <b>EP Models</b> |                 |     |     |    |    |    |    |    |
| 3A               | 1               | 3   | 36  | 65 | 65 | 65 | 58 | 58 |
| 6, 10A           | 1               | 3   | 30  | 65 | 65 | 65 | 65 | 35 |
| 7A               | 10              | 13  | 55  | 65 | 68 | 70 | 65 | 50 |
| 12A              | 11              | 7   | 43  | 70 | 70 | 70 | 65 | 45 |
| 20A              | 8               | 25  | 60  | 65 | 65 | 58 | 58 | 58 |

#### VP Models

|     |   |   |    |    |    |    |    |    |
|-----|---|---|----|----|----|----|----|----|
| 20A | 8 | - | 25 | 60 | 65 | 65 | 58 | 58 |
|-----|---|---|----|----|----|----|----|----|



RFI Power Line Filters

Single Phase Power Line Filter for Frequency Converters

# FC Series



UL Recognized



## FC Series

- Designed for frequency inverters and variable speed motor drives
- Suitable for electronically noisy environments
- Protects programmable logic controllers from RF noise on the AC power line
- Side flanges for easy mounting
- Touch safe terminals provide easy connections and prevent inadvertent contact for safety in the most demanding applications

## Ordering Information



## Available Part Numbers

|        |         |
|--------|---------|
| 6FC10  |         |
| 12FC10 | 12FC10B |
| 16FC10 | 16FC10B |
| 25FC10 | 25FC10B |
| 36FC10 | 36FC10B |
| 50FC10 | 50FC10B |

## Specifications

### Maximum leakage current each Line to Ground:

|                  | B suffix | no suffix |
|------------------|----------|-----------|
| @ 120 VAC 60 Hz: | 3.9 mA   | 3.8 mA    |
| @ 250 VAC 50 Hz: | 7.0 mA   | 6.7 mA    |

### Hipot rating (one minute):

|                 |          |
|-----------------|----------|
| Line to Ground: | 2250 VDC |
| Line to Line:   | 1450 VDC |

### Rated Voltage (max):

250 VAC

### Operating Frequency:

50/60 Hz

### Rated Current:

6 to 50A

### Operating Ambient Temperature Range

(at rated current  $I_r$ ): -10°C to +40°C  
In an ambient temperature ( $T_a$ ) higher than +40°C the maximum operating current ( $I_o$ ) is calculated as follows:  $I_o = I_r \sqrt{(85-T_a)/45}$

## Electrical Schematics

### FC10



### FC10B





Single Phase Filter for Frequency Converters *(continued)*

# FC Series

## Case Styles

### FC10 / FC10B (6, 12, 16A)



Typical Dimensions:

- Line/Load Terminals (4): DIN type accepts 10AWG solid / 12AWG stranded
- Ground Terminals (2): 8-32 screw terminals
- Mounting Holes (4): .203 x .156 [5.16 x 3.96]

### FC10 / FC10B (25, 36, 50A )



Typical Dimensions:

- Line/Load Terminals (4): DIN type accepts 8AWG solid / 10AWG stranded
- Ground Terminals (2): 8-32 screw terminals
- Mounting Slots (4): .260 [6.6] wide

## Case Dimensions

| Part No.   | A<br>(max)                  | B<br>(max)                 | C<br>(max)                  | D<br>$\pm .020$<br>$\pm .510$ | E<br>(max)                 | F<br>$\pm .010$<br>$\pm .254$ |
|------------|-----------------------------|----------------------------|-----------------------------|-------------------------------|----------------------------|-------------------------------|
| 6FC10      | <b>4.60</b><br><i>116.8</i> | <b>3.10</b><br><i>78.7</i> | <b>1.78</b><br><i>45.21</i> | <b>2.677</b><br><i>67.8</i>   | <b>3.70</b><br><i>94.0</i> | <b>2.0</b><br><i>50.8</i>     |
| 12FC10/10B | <b>5.47</b>                 | <b>3.96</b>                | <b>2.18</b>                 | <b>3.50</b>                   | <b>4.53</b>                | <b>2.0</b>                    |
| 16FC10/10B | <i>139.0</i>                | <i>100.6</i>               | <i>55.4</i>                 | <i>88.9</i>                   | <i>114.8</i>               | <i>5.08</i>                   |
| 25, 36, 50 | <b>6.90</b>                 | <b>5.48</b>                | <b>2.55</b>                 | <b>4.90</b>                   | <b>5.94</b>                | <b>2.756</b>                  |
| FC10/10B   | <i>175.3</i>                | <i>139.2</i>               | <i>64.77</i>                | <i>124.5</i>                  | <i>150.9</i>               | <i>70.0</i>                   |

1  
RFI Power Line Filters

Single Phase Filter for Frequency Converters *(continued)*

# FC Series

## Performance Data

### Typical Insertion Loss

Measured in closed 50 Ohm system

— Common Mode / Asymmetrical (L-G)  
— Differential Mode / Symmetrical (L-L)



### Minimum Insertion Loss

Common Mode / Asymmetrical (Line to Ground)

Differential Mode / Symmetrical (Line to Line)

| Part No.    | Frequency – MHz |     |     |    |    |    |    |    |    |
|-------------|-----------------|-----|-----|----|----|----|----|----|----|
|             | .01             | .03 | .05 | .1 | .5 | 1  | 5  | 10 | 30 |
| 6FC10       | 9               | 19  | 26  | 37 | 65 | 65 | 50 | 40 | 35 |
| 12FC10      | 5               | 17  | 25  | 37 | 65 | 65 | 65 | 60 | 35 |
| 16FC10      | 4               | 15  | 22  | 36 | 65 | 65 | 70 | 70 | 35 |
| 25FC10      | 2               | 14  | 22  | 36 | 75 | 75 | 70 | 70 | 48 |
| 36, 50FC10  | -               | 6   | 14  | 27 | 68 | 75 | 70 | 70 | 50 |
| 12, 16FC10B | 16              | 28  | 37  | 50 | 81 | 76 | 63 | 55 | 38 |
| 25FC10B     | 14              | 25  | 36  | 49 | 91 | 88 | 71 | 64 | 46 |
| 36FC10B     | 11              | 25  | 37  | 50 | 81 | 87 | 73 | 66 | 49 |
| 50FC10B     | 11              | 24  | 36  | 49 | 81 | 75 | 62 | 54 | 37 |

| Part No.    | Frequency – MHz |     |     |    |    |    |    |    |    |
|-------------|-----------------|-----|-----|----|----|----|----|----|----|
|             | .01             | .03 | .05 | .1 | .5 | 1  | 5  | 10 | 30 |
| 6FC10       | 10              | 10  | 35  | 60 | 75 | 75 | 60 | 50 | 45 |
| 12FC10      | 14              | 14  | 30  | 51 | 75 | 75 | 75 | 70 | 45 |
| 16FC10      | 14              | 14  | 29  | 55 | 75 | 75 | 75 | 70 | 45 |
| 25FC10      | 14              | 14  | 17  | 42 | 75 | 75 | 70 | 70 | 50 |
| 36, 50FC10  | 14              | 14  | 17  | 42 | 75 | 75 | 70 | 70 | 50 |
| 12, 16FC10B | 30              | 32  | 46  | 64 | 91 | 86 | 77 | 78 | 65 |
| 25FC10B     | 24              | 24  | 31  | 46 | 92 | 87 | 86 | 75 | 55 |
| 36FC10B     | 27              | 33  | 27  | 41 | 89 | 88 | 82 | 74 | 55 |
| 50FC10B     | 30              | 32  | 48  | 64 | 91 | 87 | 82 | 79 | 67 |

Differential Mode Filter for Fluorescent Lighting Applications

# FL Series



UL Listed



## FL Series

- Specifically designed for fluorescent lights
- Suitable for industrial environments
- UL Listed for aftermarket installation

## Ordering Information



## Available Part Number

|      |  |
|------|--|
| 3FL3 |  |
|------|--|

## Specifications

- Maximum leakage current each Line to Ground:**  
 @ 125 VAC 60 Hz: 3.0 mA  
 @280 VAC 50 Hz: 6.0 mA
- Hipot rating (one minute):**  
 Line to Ground: 1560 VAC  
 Line to Line: 1560 VAC
- Rated Voltage:** 125/280 VAC
- Operating Frequency:** 50/60 Hz
- Rated Current:** 3.9 A
- Operating Ambient Temperature Range (at rated current  $I_r$ ):** -10°C to +40°C  
 In an ambient temperature ( $T_a$ ) higher than +40°C the maximum operating current ( $I_o$ ) is calculated as follows:  $I_o = I_r \sqrt{(85-T_a)/45}$

## Electrical Schematic



**Differential Mode Filter for Fluorescent Lighting Applications** *(continued)*

# FL Series

## Case Styles



## Case Dimensions

| Part No. | A<br>(max) | B<br>(max) | C<br>(max) | D<br>$\pm .015$<br>$\pm .38$ | E<br>(max) |
|----------|------------|------------|------------|------------------------------|------------|
| 3FL3     | 3.35       | 2.07       | 1.16       | 2.938                        | 2.57       |
|          | 85.09      | 52.58      | 29.5       | 74.63                        | 65.3       |

## Performance Data

### Typical Insertion Loss

Measured in closed 50 Ohm system



— Differential Mode / Symmetrical (L-L)

### Minimum Insertion Loss

Differential Mode / Symmetrical (Line to Line)

| Part No. | Frequency – MHz |    |    |    |    |    |    |
|----------|-----------------|----|----|----|----|----|----|
|          | .15             | .3 | .6 | 1  | 4  | 10 | 20 |
| 3FL3     | 10              | 18 | 34 | 46 | 56 | 38 | 26 |

High Performance RFI Filters for Switching Power Supplies

# G Series



UL Recognized  
CSA Certified  
VDE Approved



## G Series

- Designed to provide excellent attenuation for most digital electronics equipment
- Broad frequency range of performance from 20kHz to 30MHz
- Size and cost-effective solution
- Designed to help comply with EN55022 Level A and FCC Part 15J Class B

## Ordering Information



## Available Part Numbers

|       |       |
|-------|-------|
| 6EG1  | 6VG1  |
| 10EG1 | 10VG1 |

## Specifications

### Maximum leakage current each Line to Ground:

|                  | EG Models | VG Models |
|------------------|-----------|-----------|
| @ 120 VAC 60 Hz: | .30 mA    | 1.2 mA    |
| @ 250 VAC 50 Hz: | .50 mA    | 2.0 mA    |

### Hipot rating (one minute):

|                 |          |
|-----------------|----------|
| Line to Ground: | 2250 VDC |
| Line to Line:   | 1450 VDC |

**Rated Voltage (max):** 250 VAC

**Operating Frequency:** 50/60 Hz

**Rated Current:** 6 & 10A

### Operating Ambient Temperature Range

(at rated current  $I_r$ ): -10°C to +40°C  
In an ambient temperature ( $T_a$ ) higher than +40°C the maximum operating current ( $I_o$ ) is calculated as follows:  $I_o = I_r \sqrt{(85-T_a)/45}$

## Electrical Schematics

### 6EG1 & 6VG1



### 10EG1 & 10VG1



High Performance RFI Filters for Switching Power Supplies *(continued)*

# G Series

## Case Styles



Typical Dimensions:

- Line/Load Terminals (4): .250 [6.3] with .07 [1.8] Dia. hole
- Ground Terminal (1): .250 [6.3] with .07 x .16 [1.8 x 3.8] slot
- Mounting Holes (2): .188 [4.78] Dia.

## Case Dimensions

| Part No.  | A<br>(max)                  | B<br>(max)                 | C<br>(max)                 | D<br>$\pm .015$<br>$\pm .38$ | E<br>(max)                  |
|-----------|-----------------------------|----------------------------|----------------------------|------------------------------|-----------------------------|
| 6EG1/VG1  | <b>3.56</b><br><i>90.4</i>  | <b>2.15</b><br><i>54.6</i> | <b>1.56</b><br><i>39.6</i> | <b>2.938</b><br><i>74.63</i> | <b>3.38</b><br><i>85.8</i>  |
| 10EG1/VG1 | <b>4.69</b><br><i>119.1</i> | <b>2.27</b><br><i>57.7</i> | <b>1.8</b><br><i>45.7</i>  | <b>4.063</b><br><i>103.2</i> | <b>4.47</b><br><i>113.5</i> |

## Performance Data

### Typical Insertion Loss

Measured in closed 50 Ohm system

— Common Mode / Asymmetrical (L-G)  
— Differential Mode / Symmetrical (L-L)

6EG1



6VG1



10EG1

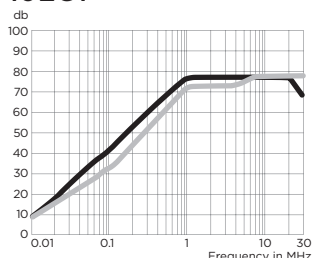

10VG1



### Minimum Insertion Loss

Common Mode / Asymmetrical (Line to Ground)

| Current Rating   | Frequency – MHz |     |     |    |     |    |    |    |    |    |
|------------------|-----------------|-----|-----|----|-----|----|----|----|----|----|
|                  | .01             | .05 | .07 | .1 | .15 | .5 | 1  | 5  | 10 | 30 |
| <b>EG Models</b> |                 |     |     |    |     |    |    |    |    |    |
| 6A               | 6               | 19  | 23  | 25 | 29  | 48 | 44 | 43 | 40 | 40 |
| 10A              | 8               | 10  | 15  | 18 | 42  | 64 | 65 | 65 | 60 | 60 |
| <b>VG Models</b> |                 |     |     |    |     |    |    |    |    |    |
| 6A               | 4               | 18  | 21  | 25 | 30  | 56 | 55 | 53 | 45 | 45 |
| 10A              | 5               | 10  | 24  | 37 | 50  | 72 | 70 | 70 | 60 | 60 |

Differential Mode / Symmetrical (Line to Line)

| Current Rating   | Frequency – MHz |     |     |    |     |    |    |    |    |    |
|------------------|-----------------|-----|-----|----|-----|----|----|----|----|----|
|                  | .01             | .05 | .07 | .1 | .15 | .5 | 1  | 5  | 10 | 30 |
| <b>EG Models</b> |                 |     |     |    |     |    |    |    |    |    |
| 6A               | 4               | 6   | 10  | 24 | 37  | 66 | 75 | 72 | 50 | 50 |
| 10A              | 5               | 5   | 5   | 26 | 40  | 65 | 65 | 60 | 70 | 70 |
| <b>VG Models</b> |                 |     |     |    |     |    |    |    |    |    |
| 6A               | 4               | 7   | 7   | 26 | 39  | 67 | 75 | 68 | 55 | 55 |
| 10A              | 5               | 5   | 7   | 26 | 39  | 65 | 60 | 60 | 70 | 70 |

Highest Performance RFI Filters for Medical Equipment

# HQ Series



UL Recognized  
CSA Certified  
VDE Approved



## HQ Series

- Designed to provide the highest available attenuation of RFI noise in the frequency range from 10kHz to 30MHz for low leakage current applications
- Size and cost-effective

## Ordering Information



\*IEC 60320-1 C14 inlet mates with C13 connector

## Specifications

**Maximum leakage current each Line to Ground:**  
 @ 120 VAC 60 Hz: 2  $\mu$ A  
 @ 250 VAC 50 Hz: 5  $\mu$ A

**Hipot rating (one minute):**  
 Line to Ground: 2250 VDC  
 Line to Line: 1450 VDC

**Rated Voltage (max):** 250 VAC

**Operating Frequency:** 50/60 Hz

**Rated Current:** 3 & 6A

**Operating Ambient Temperature Range (at rated current  $I_r$ ):** -10°C to +40°C  
 In an ambient temperature ( $T_a$ ) higher than +40°C the maximum operating current ( $I_o$ ) is calculated as follows:  $I_o = I_r \sqrt{(85-T_a)/45}$

## Available Part Numbers

|        |        |
|--------|--------|
| 3EHQ1  | 6EHQ1  |
| 3EHQ3  | 6EHQ3  |
| 3EHQ8  | 6EHQ8  |
| 3EHQ8M | 3EHQ8M |

## Accessories

GA400: NEMA 5-15P to IEC 60320-1 C-13 line cord

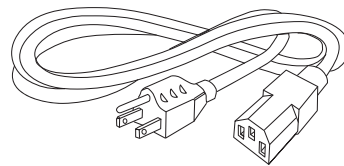

**Highest Performance RFI Filters for Medical Equipment** *(continued)*

# HQ Series

## Electrical Schematics

### 3EHQ



### 6EHQ



## Case Styles

### HQ1



Typical Dimensions:  
 Line/Load Terminals (4): .250 [6.3] with .07 [1.8] Dia. hole  
 Ground Terminal (1): .250 [6.3] with .07 x .16 [1.8 x 3.8] slot  
 Mounting Holes (2): .188 [4.78] Dia.

### HQ3



Typical Dimensions:  
 Wire Leads (5): 4.0 [101.6] Min.  
 Mounting Holes (2): .188 [4.78] Dia.

### 3EHQ8 & 3EHQ8M



Typical Dimensions:  
 Wire Leads (3): 4.0 [101.6] Min.  
 Line Inlet (1): IEC 60320-1 C14  
 HQ8 Tapped Inserts (2): 6-32 x 1/4  
 HQ8M Tapped Inserts (2): M3 x .5

### 6EHQ8 & 6EHQ8M



Typical Dimensions:  
 Wire Leads (3): 4.0 [101.6] Min.  
 Line Inlet (1): IEC 60320-1 C14  
 HQ8 Tapped Inserts (2): 6-32 x 1/4  
 HQ8M Tapped Inserts (2): M3 x .5



**Highest Performance RFI Filters for Medical Equipment** *(continued)*

# HQ Series

## Recommended Panel Cutout

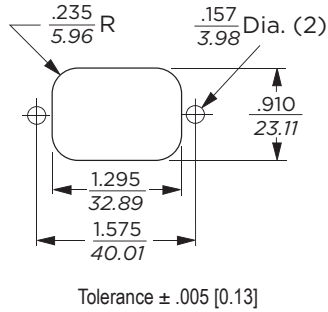

## Case Dimensions

| Part No.         | A<br>(max)           | B<br>(max)          | C<br>(max)          | D<br>$\pm .015$<br>$\pm .38$ | E<br>(max)            |
|------------------|----------------------|---------------------|---------------------|------------------------------|-----------------------|
| 3EHQ1            | <b>3.85</b><br>97.8  | <b>2.07</b><br>52.6 | <b>1.78</b><br>45.2 | <b>2.938</b><br>74.63        | <b>3.34</b><br>84.8   |
| 3EHQ3            | <b>2.56</b><br>65.0  | <b>2.07</b><br>52.6 | <b>1.78</b><br>45.2 | <b>2.938</b><br>74.63        | <b>3.34</b><br>84.8   |
| 3EHQ8,<br>3EHQ8M | <b>3.07</b><br>78.0  | <b>2.25</b><br>57.2 | <b>1.78</b><br>45.2 | <b>1.575</b><br>40.01        | <b>0.63*</b><br>16.0* |
| 6EHQ1            | <b>4.98</b><br>126.5 | <b>2.27</b><br>57.7 | <b>1.8</b><br>45.7  | <b>4.063</b><br>103.2        | <b>4.47</b><br>113.5  |
| 6EHQ3            | <b>3.69</b><br>93.7  | <b>2.27</b><br>57.7 | <b>1.8</b><br>45.7  | <b>4.063</b><br>103.2        | <b>4.47</b><br>113.5  |
| 6EHQ8,<br>6EHQ8M | <b>5.47</b><br>138.9 | <b>2.07</b><br>52.6 | <b>1.78</b><br>45.2 | <b>1.575</b><br>40.01        | <b>2.7*</b><br>68.6*  |

\*±0.02 [0.5]

1  
RFI Power Line Filters

## Performance Data

### Typical Insertion Loss

Measured in closed 50 Ohm system

#### 3EHQ



#### 6EHQ



— Common Mode / Asymmetrical (L-G)  
— Differential Mode / Symmetrical (L-L)

### Minimum Insertion Loss

Measured in closed 50 Ohm system

#### Common Mode / Asymmetrical (Line to Ground)

| Current Rating | Frequency – MHz |     |     |     |    |    |    |    |    |    |    |    |
|----------------|-----------------|-----|-----|-----|----|----|----|----|----|----|----|----|
|                | .01             | .02 | .05 | .15 | .5 | 1  | 2  | 5  | 7  | 10 | 20 | 30 |
| 3A             | 19              | 24  | 32  | 44  | 44 | 40 | 38 | 28 | 25 | 22 | 13 | 10 |
| 6A             | 24              | 29  | 39  | 42  | 28 | 35 | 36 | 30 | 30 | 24 | 16 | 15 |

#### Differential Mode / Symmetrical (Line to Line)

| Current Rating | Frequency – MHz |     |     |     |    |    |    |    |    |    |    |    |
|----------------|-----------------|-----|-----|-----|----|----|----|----|----|----|----|----|
|                | .01             | .02 | .05 | .15 | .5 | 1  | 2  | 5  | 7  | 10 | 20 | 30 |
| 3A             | 1               | 18  | 43  | 68  | 75 | 75 | 72 | 70 | 66 | 65 | 60 | 60 |
| 6A             | 6               | 10  | 43  | 70  | 75 | 75 | 75 | 65 | 50 | 55 | 50 | 40 |

High Performance RFI Power Line Filters for Medical Equipment

# HT Series



UL Recognized  
CSA Certified  
VDE Approved



## HT Series

- Designed to provide significant attenuation of RFI noise in the frequency range from 10kHz to 30MHz
- Size and cost-effective

## Specifications

**Maximum leakage current each Line to Ground:**  
 @ 120 VAC 60 Hz: 2  $\mu$ A  
 @ 250 VAC 50 Hz: 5  $\mu$ A

**Hipot rating (one minute):**  
 Line to Ground: 2250 VDC  
 Line to Line: 1450 VDC

**Rated Voltage (max):** 250 VAC

**Operating Frequency:** 50/60 Hz

**Rated Current:** 3 to 15A

**Operating Ambient Temperature Range (at rated current  $I_r$ ):** -10°C to +40°C  
 In an ambient temperature ( $T_a$ ) higher than +40°C the maximum operating current ( $I_o$ ) is calculated as follows:  $I_o = I_r \sqrt{(85-T_a)/45}$

## Ordering Information

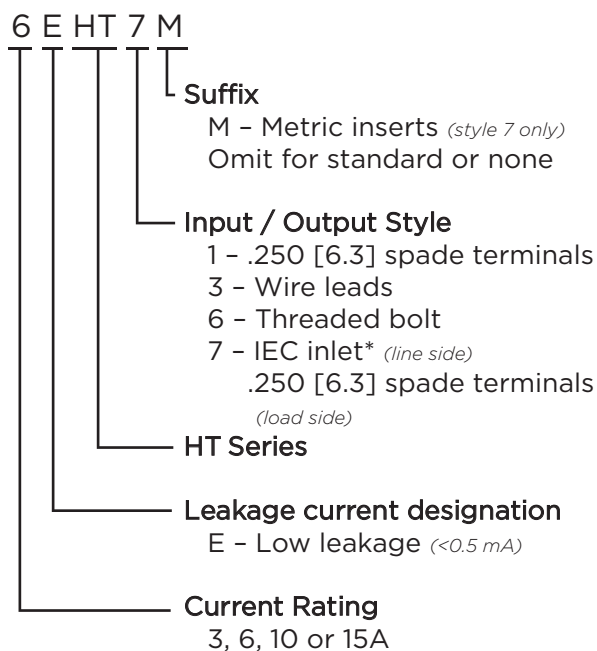

## Available Part Numbers

|        |        |
|--------|--------|
| 3EHT1  | 6EHT7  |
| 3EHT3  | 6EHT7M |
| 3EHT7  | 10EHT1 |
| 3EHT7M | 10EHT3 |
| 6EHT1  | 15EHT1 |
| 6EHT3  | 15EHT6 |

## Accessories

**GA400:** NEMA 5-15P to IEC 60320-1 C-13 line cord

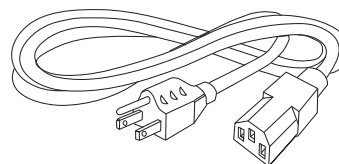

\*IEC 60320-1 C14 inlet mates with C13 connector

High Performance Power Line Filters for Medical Equipment *(continued)*

# HT Series

## Electrical Schematics

### 3 & 6EHT

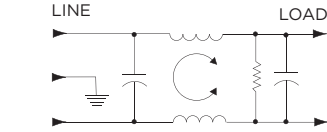

### 10EHT

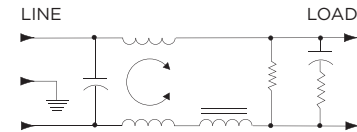

### 15EHT

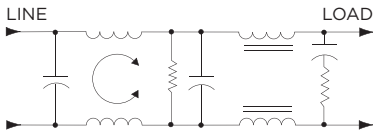

## Case Styles

### HT1 (3, 6, 10A)



Typical Dimensions:  
 Line/Load Terminals (4): .250 [6.3] with .07 [1.8] Dia. hole  
 Ground Terminal (1): .250 [6.3] with .07 x .16 [1.8 x 3.8] slot  
 Mounting Holes (2): .188 [4.78] Dia.

### HT1 (15A)



Typical Dimensions:  
 Line/Load Terminals (4): .250 [6.3] with .07 [1.8] Dia. hole  
 Ground Terminal (1): .250 [6.3] with .07 x .16 [1.8 x 3.8] slot  
 Mounting Slots (4): .203 x .156 [5.16 x 3.96] Dia.

### HT3



Typical Dimensions:  
 6A Wire Leads (5): 4.0 [101.6] Min., 18AWG  
 10A Wire Leads (5): 6.0 [152.4] Min., 18AWG  
 Mounting Holes (2): .188 [4.78] Dia.

### HT6



Typical Dimensions:  
 Terminals (5): 8-32, Torque 18 lbf-in. [2.03 N-m] max. ± 2 [22]  
 Mounting Slots (4): .203 x .156 [5.16 x 3.96] Dia.

### HT7 & HT7M



Typical Dimensions:  
 Load Terminals (2): .250 [6.3] with .07 [1.8] Dia. hole  
 Ground Terminal (1): .250 [6.3] with .07 x .16 [1.8 x 3.8] slot  
 Line Inlet (1): IEC 60320-1 C14  
 HT7 Tapped Inserts (2): 6-32 x 1/4  
 HT7M Tapped Inserts (2): M3 x .5

1  
RFI Power Line Filters

**High Performance Power Line Filters for Medical Equipment** *(continued)*

# HT Series

## Recommended Panel Cutout



## Case Dimensions

| Part No.    | A<br>(max)  | B<br>(max)  | C<br>(max)  | D<br>$\pm .015$<br>$\pm .38$ | E<br>(max)   |
|-------------|-------------|-------------|-------------|------------------------------|--------------|
| 3EHT1,      | <b>3.56</b> | <b>2.15</b> | <b>1.81</b> | <b>2.938</b>                 | <b>3.38</b>  |
| 6EHT1       | 90.4        | 54.6        | 46.0        | 74.63                        | 85.9         |
| 3EHT3,      | <b>2.55</b> | <b>2.15</b> | <b>1.81</b> | <b>2.938</b>                 | <b>3.38</b>  |
| 6EHT3       | 64.8        | 54.6        | 46.0        | 74.63                        | 85.9         |
| 3EHT7 / 7M, | <b>3.52</b> | <b>2.25</b> | <b>1.78</b> | <b>1.575</b>                 | <b>0.63*</b> |
| 6EHT7 / 7M  | 89.4        | 57.2        | 45.2        | 40.01                        | 16.0*        |
| 10EHT1      | <b>4.69</b> | <b>2.27</b> | <b>1.8</b>  | <b>4.063</b>                 | <b>4.47</b>  |
|             | 119.1       | 57.7        | 45.7        | 103.2                        | 113.5        |
| 10EHT3      | <b>3.69</b> | <b>2.27</b> | <b>1.8</b>  | <b>4.063</b>                 | <b>4.47</b>  |
|             | 93.7        | 57.7        | 45.7        | 103.2                        | 113.5        |
| 15EHT1      | <b>5.45</b> | <b>3.12</b> | <b>2.18</b> | <b>3.5</b>                   | <b>3.96</b>  |
|             | 138.4       | 79.2        | 55.4        | 88.9                         | 100.6        |
| 15EHT6      | <b>5.95</b> | <b>3.12</b> | <b>2.18</b> | <b>3.5</b>                   | <b>3.96</b>  |
|             | 151.1       | 79.2        | 55.4        | 88.9                         | 100.6        |

\*±0.02 [0.5]

## Performance Data

### Typical Insertion Loss

Measured in closed 50 Ohm system

— Common Mode / Asymmetrical (L-G)  
— Differential Mode / Symmetrical (L-L)

#### 3EHT

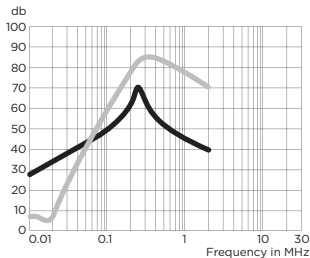

#### 6EHT

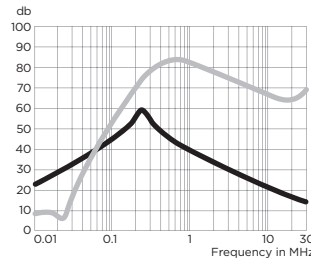

#### 10EHT

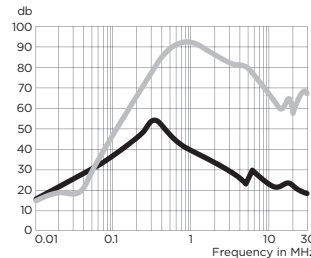

#### 15EHT

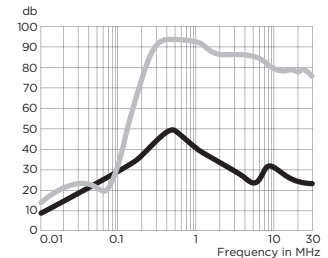

## Minimum Insertion Loss

Common Mode / Asymmetrical (Line to Ground)

| Current Rating | Frequency – MHz |     |     |     |     |    |    |    |    |    |    |    |
|----------------|-----------------|-----|-----|-----|-----|----|----|----|----|----|----|----|
|                | .02             | .02 | .05 | .08 | .15 | .5 | 1  | 2  | 5  | 10 | 20 | 30 |
| 3A             | 22              | 32  | 36  | -   | 49  | 46 | 40 | 30 | 22 | 12 | 12 | 12 |
| 6A             | 16              | 23  | 32  | 41  | 46  | 41 | 33 | 26 | 15 | 9  | 6  | 2  |
| 10A            | 9               | 15  | 24  | 30  | 36  | 42 | 34 | 22 | 11 | 12 | 8  | 8  |
| 15A            | 4               | 9   | 18  | 22  | 27  | 41 | 34 | 22 | 12 | 12 | 5  | 2  |

Differential Mode / Symmetrical (Line to Line)

| Current Rating | Frequency – MHz |     |     |     |     |    |    |    |    |    |    |    |
|----------------|-----------------|-----|-----|-----|-----|----|----|----|----|----|----|----|
|                | .02             | .02 | .05 | .08 | .15 | .5 | 1  | 2  | 5  | 10 | 20 | 30 |
| 3A             | 3               | 1   | 30  | -   | 61  | 70 | 65 | 65 | 48 | 40 | 32 | 32 |
| 6A             | 4               | 1   | 14  | 45  | 51  | 70 | 70 | 65 | 55 | 47 | 37 | 37 |
| 10A            | 7               | 8   | 17  | 32  | 52  | 70 | 70 | 70 | 65 | 55 | 40 | 35 |
| 15A            | 12              | 16  | 15  | 10  | 51  | 70 | 70 | 70 | 70 | 70 | 65 | 55 |

High Performance Power Line Filter for Medical Applications

# HZ Series



UL Recognized  
CSA Certified  
VDE Approved



## HZ Series

- Designed to provide good attenuation to RFI noise in the frequency range from 10kHz to 30MHz
- Size and cost-effective
- Low leakage current
- New versions up to 30A

## Ordering Information



## Available Part Numbers

|        |        |
|--------|--------|
| 3EHZ1  | 4EHZ1  |
| 6EHZ1  | 10EHZ1 |
| 15EHZ1 | 20EHZ1 |
| 30EHZ6 |        |

## Electrical Schematic



## Specifications

- Maximum leakage current each Line to Ground:**  
 @ 120 VAC 60 Hz: 2 µA  
 @ 250 VAC 50 Hz: 5 µA
- Hipot rating (one minute):**  
 Line to Ground: 2250 VDC  
 Line to Line: 1450 VDC
- Rated Voltage (max):** 250 VAC
- Operating Frequency:** 50/60 Hz
- Rated Current:** 3 to 30A
- Operating Ambient Temperature Range (at rated current I<sub>r</sub>):** -10°C to +40°C  
 In an ambient temperature (T<sub>a</sub>) higher than +40°C the maximum operating current (I<sub>o</sub>) is calculated as follows: I<sub>o</sub> = I<sub>r</sub> √(85-T<sub>a</sub>)/45

## Case Styles

### 3EHZ1



- Typical Dimensions:
- Line/Load Terminals (4): .250 [6.3] with .07 [1.8] Dia. hole
  - Ground Terminal (1): .250 [6.3] with .07 x .16 [1.8 x 3.8] slot
  - Mounting Holes (2): .188 [4.78] Dia.

**High Performance Power Line Filter for Medical Applications** *(continued)*

# HZ Series

## Case Styles *(continued)*

### 4EHZ1



Typical Dimensions:

- Line/Load Terminals (4): .250 [6.3] with .07 [1.8] Dia. hole
- Ground Terminal (1): .250 [6.3] with .07 x .16 [1.8 x 3.8] slot
- Mounting Holes (2): .188 [4.78] Dia.

### 6EHZ1



Typical Dimensions:

- Line/Load Terminals (4): .250 [6.3] with .07 [1.8] Dia. hole
- Ground Terminal (1): .250 [6.3] with .07 x .16 [1.8 x 3.8] slot
- Mounting Holes (2): .188 [4.78] Dia.

### 10, 15 & 20EHZ1



Typical Dimensions:

- Line/Load Terminals (4): .250 [6.3] with .07 [1.8] Dia. hole
- Ground Terminal (1): .250 [6.3] with .07 x .16 [1.8 x 3.8] slot
- Mounting Holes (2): .188 [4.78] Dia.

### 30EHZ6



Typical Dimensions:

- Terminals (5): 8-32, Torque 18 lbf-in. [2.03 N-m] max. ± 2 [2.2]
- Mounting Holes (4): .188 [4.75] Dia.

## Case Dimensions

| Part No. | A<br>(max)            | B<br>(max)           | C<br>(max)           | D<br>$\pm .015$<br>$\pm .38$ | E<br>(max)            |
|----------|-----------------------|----------------------|----------------------|------------------------------|-----------------------|
| 3EHZ1    | <i>3.54</i><br>89.91  | <i>2.08</i><br>52.8  | <i>1.31</i><br>33.3  | <i>2.938</i><br>74.63        | <i>3.35</i><br>85.1   |
| 4EHZ1    | <i>3.07</i><br>77.98  | <i>1.82</i><br>46.23 | <i>1.16</i><br>29.46 | <i>2.375</i><br>60.33        | <i>2.78</i><br>70.61  |
| 6EHZ1    | <i>3.07</i><br>77.98  | <i>1.82</i><br>46.23 | <i>1.28</i><br>32.51 | <i>2.375</i><br>60.33        | <i>2.78</i><br>70.61  |
| 10EHZ1   | <i>3.54</i>           | <i>2.047</i>         | <i>1.805</i>         | <i>2.938</i>                 | <i>3.54</i>           |
| 15EHZ1   | <i>89.92</i>          | <i>51.99</i>         | <i>45.85</i>         | <i>74.63</i>                 | <i>89.92</i>          |
| 20EHZ1   | <i>89.92</i>          | <i>51.99</i>         | <i>45.85</i>         | <i>74.63</i>                 | <i>89.92</i>          |
| 30EHZ6   | <i>4.92</i><br>124.97 | <i>2.07</i><br>52.58 | <i>1.53</i><br>38.86 | <i>3.947</i><br>100.25       | <i>4.33</i><br>109.98 |

**High Performance Power Line Filter for Medical Applications** *(continued)*

**Performance Data**

**Typical Insertion Loss**

Measured in closed 50 Ohm system

**3EHZ1**

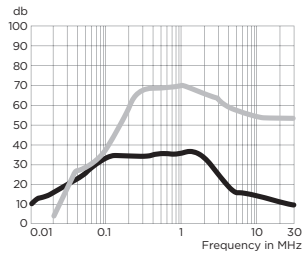

**4EHZ1**

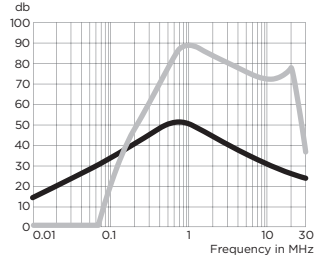

**6EHZ1**

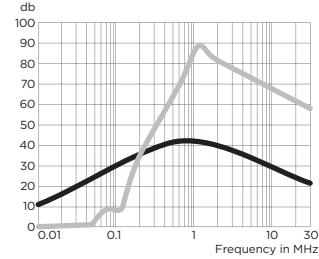

**10EHZ1**

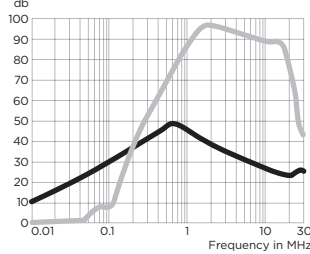

**15EHZ1**

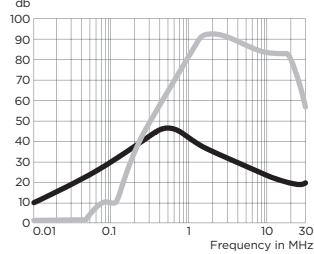

**20EHZ1**

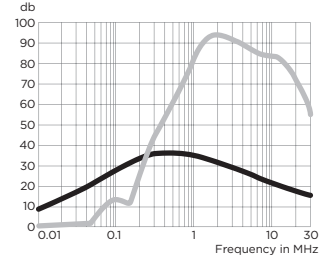

**30EHZ6**

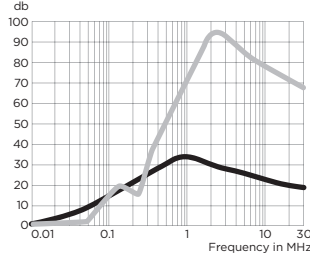

— Common Mode / Asymmetrical (L-G)  
— Differential Mode / Symmetrical (L-L)

**Minimum Insertion Loss**

Common Mode / Asymmetrical (Line to Ground)

Differential Mode / Symmetrical (Line to Line)

| Part No. | Frequency – MHz |     |    |     |    |    |    |    |    |
|----------|-----------------|-----|----|-----|----|----|----|----|----|
|          | .01             | .05 | .1 | .15 | .5 | 1  | 5  | 10 | 30 |
| 3EHZ1    | 10              | 24  | 30 | 34  | 34 | 35 | 15 | 10 | 5  |
| 4EHZ1    | 12              | 24  | 31 | 35  | 47 | 47 | 30 | 25 | 18 |
| 6EHZ1    | 9               | 21  | 27 | 30  | 36 | 34 | 27 | 22 | 16 |
| 10EHZ1   | 7               | 21  | 25 | 31  | 43 | 40 | 26 | 21 | 14 |
| 15EHZ1   | 7               | 27  | 27 | 30  | 43 | 37 | 24 | 17 | 12 |
| 20EHZ1   | 5               | 19  | 24 | 28  | 31 | 29 | 14 | 9  | 4  |
| 30EHZ6   | -               | 5   | 11 | 14  | 27 | 30 | 20 | 17 | 14 |

| Part No. | Frequency – MHz |     |    |     |    |    |    |    |    |
|----------|-----------------|-----|----|-----|----|----|----|----|----|
|          | .01             | .05 | .1 | .15 | .5 | 1  | 5  | 10 | 30 |
| 3EHZ1    | 10              | 25  | 30 | 54  | 70 | 70 | 65 | 55 | 55 |
| 4EHZ1    | -               | -   | 14 | 32  | 72 | 83 | 68 | 63 | 30 |
| 6EHZ1    | -               | -   | 7  | 17  | 59 | 80 | 67 | 60 | 52 |
| 10EHZ1   | -               | -   | 4  | 21  | 63 | 80 | 80 | 74 | 36 |
| 15EHZ1   | -               | -   | 7  | 15  | 51 | 77 | 80 | 74 | 48 |
| 20EHZ1   | -               | -   | 11 | 9   | 54 | 77 | 74 | 69 | 47 |
| 30EHZ6   | -               | -   | 13 | 14  | 47 | 67 | 76 | 70 | 58 |

Single and 2-phase RFI Filters for Industrial Applications

# IK Series



## IK Series

- Excellent performance for applications with high interference levels
- Designed for single or two-phase applications
- Wide current range
- For small to medium sized industrial equipment, power converters and variable speed motors
- Touch safe terminals on the 6 to 60A product provide easy connections and prevent inadvertent contact for safety in the most demanding applications

## Ordering Information



## Available Part Number

|        |        |
|--------|--------|
| 1IK1C  | 6IK1   |
| 16IK10 | 35IK10 |
| 50IK10 | 80IK10 |

## Specifications

### Maximum leakage current each Line to Ground:

|                 |                |         |
|-----------------|----------------|---------|
| @120 VAC 60 Hz: | 1IK & 6IK:     | 0.6 mA  |
|                 | 16, 35 & 50IK: | 1.7 mA  |
|                 | 80IK:          | 5.2 mA  |
| @289 VAC 50 Hz: | 1IK:           | 1.2 mA  |
| @277 VAC 50 Hz: | 6IK:           | 1.15 mA |
|                 | 16, 35 & 50IK: | 3.2 mA  |
|                 | 80IK:          | 9.9 mA  |

### Hipot rating (one minute):

|                 |          |
|-----------------|----------|
| Line to Ground: | 2250 VDC |
| Line to Line:   | 1450 VDC |

### Rated Voltage (max):

|                 |            |                  |
|-----------------|------------|------------------|
|                 | <b>1IK</b> | <b>6 to 80IK</b> |
| Line to Ground: | 289 VAC    | 500 VAC          |
| Line to Line:   | 277 VAC    | 480 VAC          |

### Operating Frequency:

50/60 Hz

### Rated Current:

1 to 80A

### Operating Ambient Temperature Range

(at rated current  $I_r$ ): -10°C to +40°C  
In an ambient temperature ( $T_a$ ) higher than +40°C the maximum operating current ( $I_o$ ) is calculated as follows:  $I_o = I_r \sqrt{(85-T_a)/45}$

## Electrical Schematic



Note 1: 1IK1C only  
Note 2: 6IK1 only



Single and 2-phase RFI Filters for Industrial Applications

# IK Series

## Case Styles

### 11K1C



Typical Dimensions:  
 Line/Load Terminals (4): .250 [6.3] with .07 [1.8] Dia. hole  
 Ground Terminal (1): .250 [6.3] with .07 x .16 [1.8 x 3.8] slot  
 Mounting Holes (2): .188 [4.78] Dia.

### 6IK1

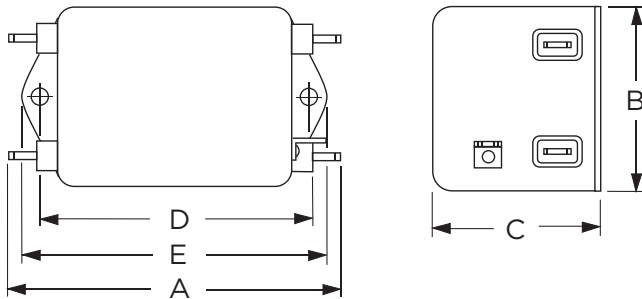

Typical Dimensions:  
 Line/Load Terminals (4): .250 [6.3] with .07 [1.8] Dia. hole  
 Ground Terminal (1): .250 [6.3] with .07 x .16 [1.8 x 3.8] slot  
 Mounting Holes (2): .188 [4.78] Dia.

### 16 & 35IK10



Typical Dimensions:  
 Input Terminals (3): DIN type terminal block  
 Output Wire Leads (2): 7.0 [180.0] min.  
 Mounting Holes (4): .216 [5.5] dia.

### 50 & 80IK10



Typical Dimensions:  
 Line / Load terminals (4): DIN type terminal block  
 Ground terminals (2): 1/4-20 screw  
 Mounting Holes (4): .260 [6.5] dia.

1  
RFI Power Line Filters

Single and 2-phase RFI Filters for Industrial Applications

# IK Series

## Case Dimensions

| Part No. | A<br>(max)           | B<br>(max)          | C<br>(max)           | D<br>$\pm .020$<br>$\pm .510$ | E<br>(max)           | F<br>$\pm .010$<br>$\pm .254$ |
|----------|----------------------|---------------------|----------------------|-------------------------------|----------------------|-------------------------------|
| 1IK1C    | <b>3.85</b><br>97.8  | <b>2.07</b><br>52.6 | <b>1.53</b><br>38.9  | <b>2.93</b><br>74.4           | <b>3.35</b><br>85.1  | -                             |
| 6IK1     | <b>4.69</b><br>119.1 | <b>2.27</b><br>57.7 | <b>1.8</b><br>45.7   | <b>4.063</b><br>103.2         | <b>4.47</b><br>113.5 | -                             |
| 16IK10   | <b>6.28</b><br>159.5 | <b>1.97</b><br>50.0 | <b>4.76</b><br>121.0 | <b>5.90</b><br>150.0          | <b>5.35</b><br>136.0 | <b>6.34</b><br>161.0          |
| 35IK10   | <b>6.48</b><br>164.5 | <b>1.97</b><br>50.0 | <b>4.76</b><br>121.0 | <b>5.90</b><br>150.0          | <b>5.35</b><br>136.0 | <b>6.34</b><br>161.0          |
| 50IK10   | <b>9.45</b>          | <b>3.94</b>         | <b>3.54</b>          | <b>6.89</b>                   | <b>6.3</b>           | <b>7.48</b>                   |
| 80IK10   | 240.0                | 100.0               | 90.0                 | 175.0                         | 160.0                | 190.0                         |

## Performance Data

### Typical Insertion Loss

Measured in closed 50 Ohm system



— Common Mode / Asymmetrical (L-G)  
— Differential Mode / Symmetrical (L-L)

**General Purpose RFI Power Line Filters - Ideal for High Impedance Load**

# K Series



UL Recognized  
CSA Certified  
VDE Approved\*\*



## K Series

- Suitable for high impedance loads
- Well suited to applications where pulsed, continuous and/or intermittent RFI interference is present
- EK models meet the very low leakage current requirements for VDE portable equipment and non-patient care medical equipment
- Available with ground line inductor (choke)

## Ordering Information



\*1-15A: IEC 60320-1 C14 inlet mates with C13 connector  
20VK7: C20 inlet mates with C19 connector

## Specifications

### Maximum leakage current each Line to Ground:

|                  | VK Models | EK Models |
|------------------|-----------|-----------|
| @ 120 VAC 60 Hz: | .5 mA     | .21 mA    |
| @ 250 VAC 50 Hz: | 1.0 mA    | .36 mA    |

### Hipot rating (one minute):

|                 |          |
|-----------------|----------|
| Line to Ground: | 2250 VDC |
| Line to Line:   | 1450 VDC |

### Rated Voltage (max):

250 VAC

### Operating Frequency:

50/60 Hz

### Rated Current:

1 to 60A\*

### Operating Ambient Temperature Range

(at rated current  $I_r$ ): -10°C to +40°C  
In an ambient temperature ( $T_a$ ) higher than +40°C the maximum operating current ( $I_o$ ) is calculated as follows:  $I_o = I_r \sqrt{(85-T_a)/45}$

## Available Part Numbers

|       |        |        |
|-------|--------|--------|
| 1VK1  | 10VK6  | 2EK3   |
| 1VK3  | 10VK7  | 3EK1   |
| 2VK1  | 10VK7M | 3EK3   |
| 2VK3  | 20VK1  | 3EK7   |
| 3VK1  | 20VK6  | 3EK7M  |
| 3VK3  | 20VK7* | 5EK1   |
| 3VK7  | 30VK6  | 5EK3   |
| 3VK7M | 30VK6C | 5EK7   |
| 5VK1  | 40VK6  | 5EK7M  |
| 5VK3  | 40VK6C | 10EK1  |
| 5VK7  | 60VK6  | 10EK3  |
| 5VK7M | 1EK1   | 10EK7  |
| 10VK1 | 1EK3   | 10EK7M |
| 10VK3 | 2EK1   | 20EK1  |

\*\*20VK7, 20A model tested by Underwriters Laboratories to US and Canadian requirements and is VDE approved at 16A, 250VAC

General Purpose RFI Power Line Filters (continued)

# K Series

## Electrical Schematics



### 30 & 40VK6C (Inductor in Ground Line)



### 60VK6



## Accessories

GA400: NEMA 5-15P to IEC 60320-1 C-13 line cord

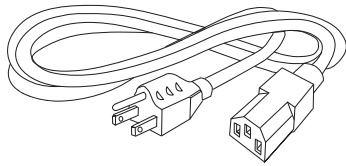

## Case Styles

### K1 (1, 2, 3, 6, 10A)



Typical Dimensions:  
Line/Load Terminals (4): .250 [6.3] with .07 [1.8] Dia. hole  
Ground Terminal (1): .250 [6.3] with .07 x .16 [1.8 x 3.8] slot  
Mounting Holes (2): .188 [4.78] Dia.

### K1 (20A)



Typical Dimensions:  
Line/Load Terminals (4): .250 [6.3] with .07 [1.8] Dia. hole  
Ground Terminal (1): .250 [6.3] with .07 x .16 [1.8 x 3.8] slot  
Mounting Holes (2): .188 [4.78] Dia.

### K3



Typical Dimensions:  
Wire Leads (5): 4.0 [101.6] Min., AWG18 (AWG16 for 10A)  
Mounting Holes (2): .188 [4.78] Dia.

General Purpose RFI Power Line Filters (continued)

# K Series

## Case Styles (continued)

### 10VK6



Typical Dimensions:  
 Terminals (5): 8-32, Torque 18 lbf-in. [2.03 N-m] max. ± 2 [.22]  
 Mounting Holes (2): .188 [4.78] Dia.

### 20VK6



Typical Dimensions:  
 Terminals (5): 8-32, Torque 18 lbf-in. [2.03 N-m] max. ± 2 [.22]  
 Mounting Holes (2): .188 [4.78] Dia.

### 30VK6/6C & 40VK6/6C



Typical Dimensions:  
 Terminals (5): 8-32, Torque 18 lbf-in. [2.03 N-m] max. ± 2 [.22]  
 Mounting Slots (4): .250 x .156 [6.35 x 3.96] Dia.

### 60VK6



Typical Dimensions:  
 Terminals (5): 1/4-20, Torque 56 lbf-in. [6.32 N-m] max. ± 2 [.22]  
 Mounting Slots (4): .250 x .156 [6.35 x 3.96] Dia.

### K7 & K7M (3, 5, 10A)

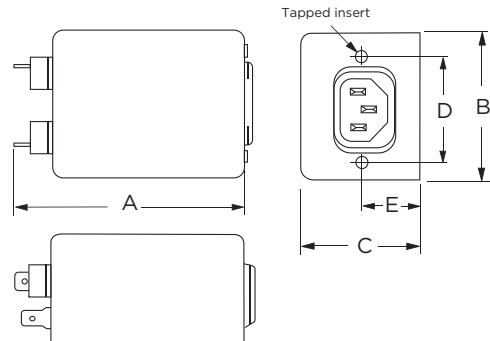

Typical Dimensions:  
 Load Terminals (2): .250 [6.3] with .07 [1.8] Dia. hole  
 Ground Terminal (1): .250 [6.3] with .07 x .16 [1.8 x 3.8] slot  
 Line Inlet (1): IEC 60320-1 C14  
 K7 Tapped Inserts (2): 6-32 x 1/4  
 K7M Tapped Inserts (2): M3 x .5

### 20VK7

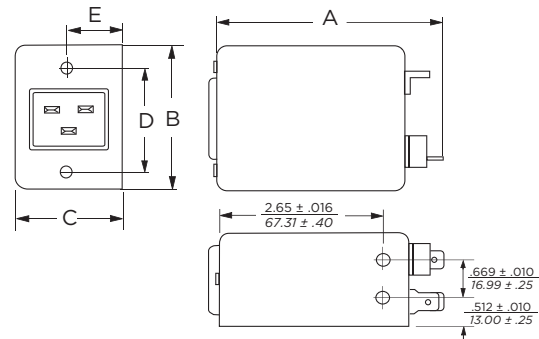

Typical Dimensions:  
 Load Terminals (2): .250 [6.3] with .07 [1.8] Dia. hole  
 Ground Terminal (1): .250 [6.3] with .07 x .16 [1.8 x 3.8] slot  
 Line Inlet (1): IEC 60320-1 C20  
 K7 Tapped Inserts (2): 6-32 x 1/4  
 K7M Tapped Inserts (2): M3 x .5



RFI Power Line Filters

General Purpose RFI Power Line Filters (continued)

# K Series

## Case Dimensions

| Part No.    | A<br>(max)  | B<br>(max)  | C<br>(max)  | D<br>$\pm .015$<br>$\pm .38$ | E<br>(max)   |
|-------------|-------------|-------------|-------------|------------------------------|--------------|
| 1VK1, 1EK1, | <b>3.1</b>  | <b>2.07</b> | <b>0.91</b> | <b>2.375</b>                 | <b>2.81</b>  |
| 2VK1, 2EK1  | 78.7        | 52.6        | 23.1        | 60.33                        | 74.1         |
| 1VK3, 1EK3, | <b>1.81</b> | <b>2.07</b> | <b>0.91</b> | <b>2.375</b>                 | <b>2.81</b>  |
| 2VK3, 2EK3  | 46.0        | 52.6        | 23.1        | 60.33                        | 74.1         |
| 3VK1, 3EK1, | <b>3.10</b> | <b>2.07</b> | <b>1.16</b> | <b>2.375</b>                 | <b>2.81</b>  |
| 5VK1, 5EK1  | 78.7        | 52.6        | 29.5        | 60.33                        | 74.1         |
| 3VK3, 3EK3, | <b>1.81</b> | <b>2.07</b> | <b>1.16</b> | <b>2.375</b>                 | <b>2.81</b>  |
| 5VK5, 5EK3  | 46.0        | 52.6        | 29.5        | 60.33                        | 74.4         |
| 3VK7/7M,    | <b>3.21</b> | <b>2.25</b> | <b>1.28</b> | <b>1.575</b>                 | <b>0.63*</b> |
| 3EK7/7M     | 81.5        | 57.2        | 32.5        | 40.01                        | 16.0*        |
| 5VK7/7M,    | <b>3.21</b> | <b>2.25</b> | <b>1.28</b> | <b>1.575</b>                 | <b>0.63*</b> |
| 5EK7/7M     | 81.5        | 57.2        | 32.5        | 40.01                        | 16.0*        |
| 10VK1,      | <b>3.35</b> | <b>2.07</b> | <b>1.16</b> | <b>2.375</b>                 | <b>2.81</b>  |
| 10EK1       | 85.1        | 52.6        | 29.5        | 60.33                        | 71.4         |
| 10VK3,      | <b>2.07</b> | <b>2.07</b> | <b>1.16</b> | <b>2.375</b>                 | <b>2.81</b>  |
| 10EK3       | 52.6        | 52.6        | 29.5        | 60.33                        | 71.4         |
| 10VK6       | <b>3.46</b> | <b>2.07</b> | <b>1.16</b> | <b>2.375</b>                 | <b>2.81</b>  |
|             | 87.9        | 52.6        | 29.5        | 60.33                        | 71.4         |
| 10VK7/7M,   | <b>3.71</b> | <b>2.25</b> | <b>1.28</b> | <b>1.575</b>                 | <b>0.63*</b> |
| 10EK7/7M    | 94.2        | 57.2        | 32.5        | 40.01                        | 16.0*        |
| 20VK1,      | <b>3.35</b> | <b>2.56</b> | <b>1.53</b> | <b>2.938</b>                 | <b>3.35</b>  |
| 20EK1       | 85.1        | 65.0        | 38.9        | 74.63                        | 85.1         |
| 20VK6       | <b>3.46</b> | <b>2.56</b> | <b>1.53</b> | <b>2.938</b>                 | <b>3.35</b>  |
|             | 87.9        | 65.0        | 38.9        | 74.63                        | 85.1         |
| 20VK7       | <b>3.8</b>  | <b>2.28</b> | <b>1.78</b> | <b>1.575</b>                 | <b>.846*</b> |
|             | 90.4        | 54.6        | 39.6        | 74.63                        | 85.8*        |
| 30VK6,      | <b>5.34</b> | <b>3.38</b> | <b>1.53</b> | <b>3.75</b>                  | <b>4.20</b>  |
| 30VK6C      | 135.6       | 85.9        | 38.9        | 95.25                        | 106.7        |
| 40VK6,      | <b>5.34</b> | <b>3.38</b> | <b>1.53</b> | <b>3.75</b>                  | <b>4.20</b>  |
| 40VK6C      | 135.6       | 85.9        | 38.9        | 95.25                        | 106.7        |
| 60VK6       | <b>6.0</b>  | <b>3.38</b> | <b>1.53</b> | <b>3.75</b>                  | <b>4.20</b>  |
|             | 152.4       | 85.9        | 38.9        | 95.25                        | 106.7        |

\*±0.02 [0.5]  
†±0.01 [0.25]

## Recommended Panel Cutouts

### K7 & K7M Cutout (3, 5, 10A)



### 20VK7 Cutout

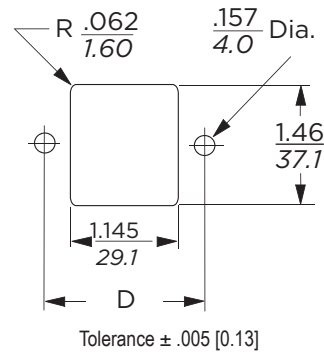

## Performance Data

### Typical Insertion Loss

Measured in closed 50 Ohm system

#### 1 & 3EK



#### 2 & 10EK



#### 5EK



#### 20EK



General Purpose RFI Power Line Filters (continued)

# K Series

## Performance Data (continued)

### Typical Insertion Loss

Measured in closed 50 Ohm system

1VK



2VK



3VK



5VK



10VK



20VK



30VK & 30VK6C



40VK & 40VK6C



60VK



— Common Mode / Asymmetrical (L-G)  
— Differential Mode / Symmetrical (L-L)

### Minimum Insertion Loss

Measured in closed 50 Ohm system

Common Mode / Asymmetrical (Line to Ground)

| Current Rating   | Frequency – MHz |    |    |    |    |    |
|------------------|-----------------|----|----|----|----|----|
|                  | .15             | .5 | 1  | 5  | 10 | 30 |
| <b>VK Models</b> |                 |    |    |    |    |    |
| 1A, 3A           | 15              | 30 | 38 | 50 | 50 | 50 |
| 2A, 5A, 10A      | 6               | 19 | 28 | 42 | 45 | 50 |
| 20A              | 6               | 19 | 28 | 42 | 45 | 50 |
| 30A, 40A         | 6               | 19 | 28 | 42 | 45 | 50 |
| 60A              | 6               | 22 | 28 | 32 | 39 | 35 |
| <b>EK Models</b> |                 |    |    |    |    |    |
| 1A, 3A           | 15              | 29 | 35 | 45 | 45 | 50 |
| 2A, 5A, 10A      | 8               | 19 | 25 | 38 | 40 | 45 |
| 20A              | 8               | 19 | 25 | 38 | 40 | 45 |

Differential Mode / Symmetrical (Line to Line)

| Current Rating   | Frequency – MHz |    |    |    |    |    |
|------------------|-----------------|----|----|----|----|----|
|                  | .15             | .5 | 1  | 5  | 10 | 30 |
| <b>VK Models</b> |                 |    |    |    |    |    |
| 1A, 3A           | -               | -  | 48 | 55 | 50 | 35 |
| 2A, 5A, 10A      | -               | -  | 30 | 50 | 30 | 30 |
| 20A              | 6               | 6  | 30 | 50 | 30 | 30 |
| 30A, 40A         | 2               | 40 | 60 | 65 | 57 | 55 |
| 60A              | 13              | 49 | 67 | 57 | 53 | 53 |
| <b>EK Models</b> |                 |    |    |    |    |    |
| 1A, 3A           | -               | -  | 48 | 55 | 50 | 35 |
| 2A, 5A, 10A      | -               | -  | 30 | 50 | 30 | 30 |
| 20A              | 6               | 6  | 30 | 50 | 30 | 30 |

**Multi-purpose Medical Filter for Power Line Noise Protection**

# MV Series



UL Recognized  
CSA Certified  
VDE Approved



## MV Series

- Multi-purpose medical filter
- Improved Line to Ground performance
- A good solution to emission or immunity problems
- Meets leakage current requirements of UL2601 for health care equipment

## Specifications

**Maximum leakage current each Line to Ground:**  
 @ 120 VAC 60 Hz: .07 mA  
 @ 250 VAC 50 Hz: .13 mA

**Hipot rating (one minute):**  
 Line to Ground: 2250 VDC  
 Line to Line: 1450 VDC

**Rated Voltage (max):** 250 VAC

**Operating Frequency:** 50/60 Hz

**Rated Current:** 3 to 20A

**Operating Ambient Temperature Range**  
**(at rated current  $I_r$ ):** -10°C to +40°C  
 In an ambient temperature ( $T_a$ ) higher than +40°C  
 the maximum operating current ( $I_o$ ) is calculated as  
 follows:  $I_o = I_r \sqrt{(85-T_a)/45}$

## Ordering Information



## Electrical Schematic



## Available Part Numbers

|       |       |
|-------|-------|
| 3MV1  | 6MV1  |
| 10MV1 | 20MV1 |



Multi-purpose Medical Filter for Power Line Noise Protection *(continued)*

# MV Series

## Case Styles

MV1 (3, 6, 10A)



Typical Dimensions:

- Line/Load Terminals (4): .250 [6.3] with .07 [1.8] Dia. hole
- Ground Terminal (1): .250 [6.3] with .07 x .16 [1.8 x 3.8] slot
- Mounting Holes (2): .188 [4.78] Dia.

20MV1



Typical Dimensions:

- Line/Load Terminals (4): .250 [6.3] with .07 [1.8] Dia. hole
- Ground Terminal (1): .250 [6.3] with .07 x .16 [1.8 x 3.8] slot
- Mounting Holes (2): .188 [4.78] Dia.

## Case Dimensions

| Part No. | A<br>(max)           | B<br>(max)          | C<br>(max)          | D<br>$\pm .015$<br>$\pm .38$ | E<br>(max)           |
|----------|----------------------|---------------------|---------------------|------------------------------|----------------------|
| 3MV1     | <b>3.36</b><br>85.3  | <b>1.82</b><br>46.2 | <b>1.28</b><br>32.5 | <b>2.375</b><br>60.33        | <b>2.78</b><br>70.6  |
| 6MV1     | <b>3.86</b><br>98.0  | <b>2.08</b><br>52.8 | <b>1.53</b><br>38.9 | <b>2.938</b><br>74.63        | <b>3.34</b><br>84.8  |
| 10MV1    | <b>3.86</b><br>98.0  | <b>2.08</b><br>52.8 | <b>1.53</b><br>38.9 | <b>2.938</b><br>74.63        | <b>3.34</b><br>84.8  |
| 20MV1    | <b>5.23</b><br>132.8 | <b>3.38</b><br>85.9 | <b>1.53</b><br>38.9 | <b>3.75</b><br>95.25         | <b>4.20</b><br>106.7 |

## Performance Data

### Typical Insertion Loss

Measured in closed 50 Ohm system

3MV



6MV



10MV



20MV



— Common Mode / Asymmetrical (L-G)  
— Differential Mode / Symmetrical (L-L)

### Minimum Insertion Loss

Measured in closed 50 Ohm system

Common Mode / Asymmetrical (Line to Ground)

| Current Rating | Frequency – MHz |    |    |    |    |    |    |    |
|----------------|-----------------|----|----|----|----|----|----|----|
|                | .15             | .5 | 1  | 2  | 5  | 10 | 20 | 30 |
| 3A             | 14              | 19 | 20 | 30 | 46 | 40 | 34 | 31 |
| 6A             | 19              | 27 | 30 | 38 | 50 | 40 | 35 | 35 |
| 10A            | 15              | 25 | 26 | 34 | 46 | 50 | 44 | 42 |
| 20A            | 18              | 30 | 34 | 34 | 46 | 40 | 36 | 20 |

Differential Mode / Symmetrical (Line to Line)

| Current Rating | Frequency – MHz |    |    |    |    |    |    |    |
|----------------|-----------------|----|----|----|----|----|----|----|
|                | .15             | .5 | 1  | 2  | 5  | 10 | 20 | 30 |
| 3A             | 33              | 65 | 65 | 65 | 65 | 60 | 53 | 50 |
| 6A             | 40              | 65 | 65 | 65 | 65 | 60 | 57 | 55 |
| 10A            | 33              | 65 | 65 | 65 | 65 | 65 | 55 | 55 |
| 20A            | 25              | 65 | 65 | 65 | 65 | 60 | 57 | 45 |

**High Performance RFI Filters for Switching Power Supplies**

# N Series



UL Recognized  
CSA Certified  
VDE Approved



## N Series

- Superior attenuation for most digital electronic equipment over the frequency range of 10kHz to 30MHz
- Provides excellent common mode and differential mode performance
- Cost-effective solution to very noisy equipment that must meet conducted emission limits

## Ordering Information

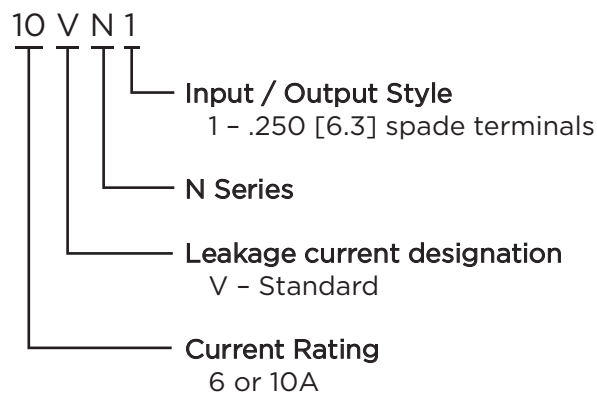

## Available Part Numbers

|      |       |
|------|-------|
| 6VN1 | 10VN1 |
|------|-------|

## Specifications

**Maximum leakage current each Line to Ground:**

|                  |        |
|------------------|--------|
| @ 120 VAC 60 Hz: | 1.2 mA |
| @ 250 VAC 50 Hz: | 2.0 mA |

**Hipot rating (one minute):**

|                 |          |
|-----------------|----------|
| Line to Ground: | 2250 VDC |
| Line to Line:   | 1450 VDC |

**Rated Voltage (max):**

250 VAC

**Operating Frequency:**

50/60 Hz

**Rated Current:**

6 to 10A

**Operating Ambient Temperature Range**

(at rated current  $I_r$ ): -10°C to +40°C  
In an ambient temperature ( $T_a$ ) higher than +40°C the maximum operating current ( $I_o$ ) is calculated as follows:  $I_o = I_r \sqrt{(85-T_a)/45}$

## Electrical Schematics

### 3VN

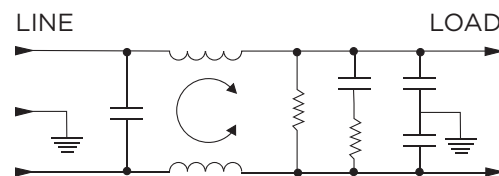

### 10VN

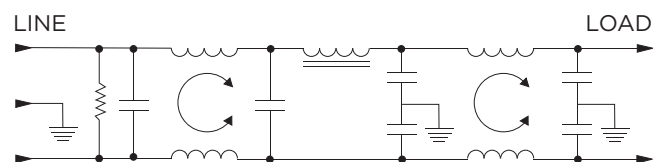

High Performance RFI Filters for Switching Power Supplies *(continued)*

# N Series

## Case Styles



Typical Dimensions:

- Line/Load Terminals (4): 250 [6.3] with .07 [1.8] Dia. hole
- Ground Terminal (1): 250 [6.3] with .07 x .16 [1.8 x 3.8] slot
- Mounting Holes (2): .188 [4.78] Dia.

## Case Dimensions

| Part No. | A<br>(max)                  | B<br>(max)                 | C<br>(max)                 | D<br>$\pm .015$<br>$\pm .38$ | E<br>(max)                  |
|----------|-----------------------------|----------------------------|----------------------------|------------------------------|-----------------------------|
| 6VN1     | <b>3.56</b><br><i>90.4</i>  | <b>2.15</b><br><i>54.6</i> | <b>1.81</b><br><i>45.9</i> | <b>2.938</b><br><i>74.63</i> | <b>3.38</b><br><i>85.8</i>  |
| 10VN1    | <b>4.69</b><br><i>119.1</i> | <b>2.27</b><br><i>57.7</i> | <b>1.8</b><br><i>45.7</i>  | <b>4.063</b><br><i>103.2</i> | <b>4.47</b><br><i>113.5</i> |

## Performance Data

### Typical Insertion Loss

Measured in closed 50 Ohm system

#### 6VN



#### 10VN



- Common Mode / Asymmetrical (L-G)
- - - Differential Mode / Symmetrical (L-L)

## Minimum Insertion Loss

Measured in closed 50 Ohm system

Common Mode / Asymmetrical (Line to Ground)

| Current Rating | Frequency – MHz |     |    |     |    |    |    |    |    |
|----------------|-----------------|-----|----|-----|----|----|----|----|----|
|                | .01             | .05 | .1 | .15 | .5 | 1  | 5  | 10 | 30 |
| 6A             | 6               | 20  | 28 | 34  | 58 | 54 | 53 | 53 | 43 |
| 10A            | 8               | 8   | 44 | 55  | 75 | 70 | 70 | 70 | 55 |

Differential Mode / Symmetrical (Line to Line)

| Current Rating | Frequency – MHz |     |    |     |    |    |    |    |    |
|----------------|-----------------|-----|----|-----|----|----|----|----|----|
|                | .01             | .05 | .1 | .15 | .5 | 1  | 5  | 10 | 30 |
| 6A             | 6               | 14  | 41 | 52  | 66 | 77 | 72 | 60 | 60 |
| 10A            | 6               | 6   | 35 | 45  | 72 | 70 | 72 | 75 | 70 |

**Highest Performance RFI Filters for Switching Power Supplies**

# Q Series



UL Recognized  
CSA Certified  
VDE Approved



## Q Series

- Specifically developed for switching power supplies
- High attenuation for common and differential mode interference
- Effective from 10kHz to 30MHz
- Optimized for attenuation and size
- 3 or 6A versions available with IEC inlet

## Ordering Information



\*IEC 60320-1 C14 inlet mates with C13 connector

## Specifications

**Maximum leakage current each Line to Ground:**

|                    | VQ Models | EQ Models |
|--------------------|-----------|-----------|
| <b>3 &amp; 20A</b> |           |           |
| @120 VAC 60 Hz:    | .73 mA    | .22 mA    |
| @250 VAC 50 Hz:    | 1.27 mA   | .38 mA    |
| <b>6A</b>          |           |           |
| @120 VAC 60 Hz:    | —         | .29 mA    |
| @250 VAC 50 Hz:    | —         | .51 mA    |

**Hipot rating (one minute):**

|                 |          |
|-----------------|----------|
| Line to Ground: | 2250 VDC |
| Line to Line:   | 1450 VDC |

**Rated Voltage (max):** 250 VAC

**Operating Frequency:** 50/60 Hz

**Rated Current:** 3 to 20A

**Operating Ambient Temperature Range**

(at rated current  $I_r$ ): -10°C to +40°C  
In an ambient temperature ( $T_a$ ) higher than +40°C the maximum operating current ( $I_o$ ) is calculated as follows:  $I_o = I_r \sqrt{(85-T_a)/45}$

## Available Part Numbers

|       |       |
|-------|-------|
| 3EQ1  | 6EQ8M |
| 3EQ3  | 20EQ1 |
| 3EQ8  | 3VQ1  |
| 3EQ8M | 3VQ3  |
| 6EQ1  | 3VQ8  |
| 6EQ3  | 3VQ8M |
| 6EQ8  | 20VQ1 |

## Accessories

GA400: NEMA 5-15P to IEC 60320-1 C-13 line cord



**Highest Performance RFI Filters for Switching Power Supplies** *(continued)*

# Q Series

## Electrical Schematics

### 3A



### 6, 20A



## Case Styles

### Q1



Typical Dimensions:

- Line/Load Terminals (4): .250 [6.3] with .07 [1.8] Dia. hole
- Ground Terminal (1): .250 [6.3] with .07 x .16 [1.8 x 3.8] slot
- Mounting Holes (2): .188 [4.78] Dia.

### Q3



Typical Dimensions:

- Wire Leads (5): 4.0 [101.6] Min., 18AWG
- Mounting Holes (2): .188 [4.78] Dia.

### Q8, Q8M (3A)



Typical Dimensions:

- Wire Leads (3): 6.0 [152.4] Min., 18AWG
- Line Inlet (1): IEC 60320-1 C14
- Q8 Tapped Inserts (2): 6-32 x 1/4
- Q8M Tapped Inserts (2): M3 x .5

### Q8, Q8M (6A)



Typical Dimensions:

- Wire Leads (3): 6.0 [152.4] Min., 18AWG
- Line Inlet (1): IEC 60320-1 C14
- Q8 Tapped Inserts (3): 6-32 x 1/4
- Q8M Tapped Inserts (3): M3 x .5

## Case Dimensions

| Part No.            | A<br>(max)  | B<br>(max)  | C<br>(max)  | D<br>±.015<br>±.38 | E<br>(max)   |
|---------------------|-------------|-------------|-------------|--------------------|--------------|
| 3VQ1, 3EQ1          | <b>3.85</b> | <b>2.07</b> | <b>1.78</b> | <b>2.938</b>       | <b>3.34</b>  |
|                     | 97.8        | 52.6        | 45.2        | 74.63              | 84.8         |
| 3VQ3, 3EQ3          | <b>2.56</b> | <b>2.07</b> | <b>1.78</b> | <b>2.938</b>       | <b>3.34</b>  |
|                     | 65.0        | 52.6        | 45.2        | 74.63              | 84.8         |
| 3VQ8/8M,<br>3EQ8/8M | <b>3.07</b> | <b>2.25</b> | <b>1.78</b> | <b>1.575</b>       | <b>0.63*</b> |
|                     | 78.0        | 57.2        | 45.2        | 40.01              | 16.0*        |
| 6EQ1                | <b>4.98</b> | <b>2.27</b> | <b>1.80</b> | <b>4.063</b>       | <b>4.47</b>  |
|                     | 126.5       | 57.7        | 45.7        | 103.2              | 113.5        |
| 6EQ3                | <b>3.69</b> | <b>2.27</b> | <b>1.80</b> | <b>4.063</b>       | <b>4.47</b>  |
|                     | 93.7        | 57.7        | 45.7        | 103.2              | 113.5        |
| 6EQ8/8M             | <b>5.47</b> | <b>2.07</b> | <b>1.78</b> | <b>1.575</b>       | <b>2.70</b>  |
|                     | 138.9       | 52.6        | 45.2        | 40.01              | 68.0         |
| 20EQ1,<br>20VQ1     | <b>6.66</b> | <b>2.07</b> | <b>2.28</b> | <b>5.625</b>       | <b>6.03*</b> |
|                     | 168.1       | 52.6        | 57.9        | 142.9              | 153.2*       |

\*±0.02 [0.5]

**Highest Performance RFI Filters for Switching Power Supplies** *(continued)*

# Q Series

## Recommended Panel Cutout



Tolerance  $\pm .005$  [0.13]

## Performance Data

### Typical Insertion Loss

Measured in closed 50 Ohm system

#### 3VQ



#### 3EQ



#### 6EQ



#### 20VQ



#### 20EQ



— Common Mode / Asymmetrical (L-G)  
— Differential Mode / Symmetrical (L-L)

## Minimum Insertion Loss

Common Mode / Asymmetrical (Line to Ground)

| Current Rating | Frequency – MHz |     |     |     |    |    |    |    |    |
|----------------|-----------------|-----|-----|-----|----|----|----|----|----|
|                | .01             | .02 | .05 | .15 | .5 | 1  | 5  | 10 | 30 |
| 3VQ            | 22              | 27  | 37  | 50  | 55 | 55 | 55 | 50 | 55 |
| 3EQ            | 22              | 27  | 36  | 47  | 47 | 43 | 45 | 45 | 45 |
| 6EQ            | 26              | 31  | 20  | 68  | 72 | 72 | 65 | 65 | 65 |
| 20EQ           | 6               | 10  | 8   | 39  | 60 | 65 | 65 | 65 | 55 |
| 20VQ           | 6               | 3   | 17  | 52  | 65 | 70 | 70 | 70 | 70 |

Differential Mode / Symmetrical (Line to Line)

| Current Rating | Frequency – MHz |     |     |     |    |    |    |    |    |
|----------------|-----------------|-----|-----|-----|----|----|----|----|----|
|                | .01             | .02 | .05 | .15 | .5 | 1  | 5  | 10 | 30 |
| 3VQ            | 1               | 17  | 42  | 65  | 75 | 75 | 60 | 65 | 65 |
| 3EQ            | 1               | 17  | 42  | 65  | 75 | 75 | 65 | 65 | 60 |
| 6EQ            | 6               | 10  | 43  | 70  | 75 | 75 | 65 | 55 | 55 |
| 20EQ           | 15              | 20  | 20  | 46  | 65 | 70 | 65 | 60 | 60 |
| 20VQ           | 15              | 20  | 20  | 46  | 65 | 70 | 65 | 60 | 60 |

**Two-stage General Purpose RFI Power Line Filter**

# R Series



UL Recognized  
CSA Certified  
VDE Approved



## R Series

- Dual T section RFI filter provides premium performance
- Well suited for low impedance loads where noisy RFI environments are present
- Controls pulsed, continuous and/or intermittent interference
- ER models offer low leakage current without deterioration of insertion loss

## Ordering Information



\*IEC 60320-1 C14 inlet mates with C13 connector

## Specifications

### Maximum leakage current each Line to Ground:

|                 | VR Models | ER Models |
|-----------------|-----------|-----------|
| @120 VAC 60 Hz: | .4 mA     | .21 mA    |
| @250 VAC 50 Hz: | .7 mA     | .36 mA    |

### Hipot rating (one minute):

|                 |          |
|-----------------|----------|
| Line to Ground: | 2250 VDC |
| Line to Line:   | 1450 VDC |

**Rated Voltage (max):** 250 VAC

**Operating Frequency:** 50/60 Hz

**Rated Current:** 1 to 20A

### Operating Ambient Temperature Range

(at rated current  $I_r$ ): -10°C to +40°C  
In an ambient temperature ( $T_a$ ) higher than +40°C the maximum operating current ( $I_o$ ) is calculated as follows:  $I_o = I_r \sqrt{(85-T_a)/45}$

## Available Part Numbers

|        |        |
|--------|--------|
| 1VR1   | 1ER1   |
| 1VR3   | 1ER3   |
| 2VR1   | 2ER1   |
| 2VR3   | 2ER3   |
| 3VR1   | 3ER1   |
| 3VR3   | 3ER3   |
| 3VR7   | 3ER7   |
| 3VR7M  | 3ER7M  |
| 5VR1   | 5ER1   |
| 5VR3   | 5ER3   |
| 5VR7   | 5ER7   |
| 5VR7M  | 5ER7M  |
| 10VR1  | 10ER1  |
| 10VR3  | 10ER3  |
| 10VR6  | 10ER7  |
| 10VR7  | 10ER7M |
| 10VR7M | 20ER1  |
| 20VR1  |        |
| 20VR6  |        |

**Two-stage General Purpose RFI Power Line Filter** *(continued)*

# R Series

## Electrical Schematic



## Case Styles

### R1 (1, 2, 3, 5, 10A)



Typical Dimensions:  
 Line/Load Terminals (4): .250 [6.3] with .07 [1.8] Dia. hole  
 Ground Terminal (1): .250 [6.3] with .07 x .16 [1.8 x 3.8] slot  
 Mounting Holes (2): .188 [4.78] Dia.

### R1 (20A)



Typical Dimensions:  
 Line/Load Terminals (4): .250 [6.3] with .07 [1.8] Dia. hole  
 Ground Terminal (1): .250 [6.3] with .07 x .16 [1.8 x 3.8] slot  
 Mounting Slots (4): .250 x .156 [6.35 x 3.96] Dia.

## Case Styles *(continued)*

### R3



Typical Dimensions:  
 Wire Leads (5): 4.0 [101.6] Min., AWG18  
 Mounting Holes (2): .188 [4.78] Dia.

### 10VR6



Typical Dimensions:  
 Terminals (5): 8-32, Torque 18 lbf-in. [2.03 N-m] max. ± 2 [.22]  
 Mounting Holes (2): .188 [4.78] Dia.

### 20VR6



Typical Dimensions:  
 Terminals (5): 8-32, Torque 18 lbf-in. [2.03 N-m] max. ± 2 [.22]  
 Mounting Slots (4): .250 x .156 [6.35 x 3.96] Dia.



**Two-stage General Purpose RFI Power Line Filter** *(continued)*

# R Series

## Case Styles *(continued)*

### R7 & R7M



Typical Dimensions:

- Load Terminals (2): .250 [6.3] with .07 [1.8] Dia. hole
- Ground Terminal (1): .250 [6.3] with .07 x .16 [1.8 x 3.8] slot
- Line Inlet (1): IEC 60320-1 C14
- K7 Tapped Inserts (2): 6-32 x 1/4
- K7M Tapped Inserts (2): M3 x .5

## Recommended Panel Cutout



## Accessories

**GA400:** NEMA 5-15P to IEC 60320-1 C-13 line cord



## Case Dimensions

| Part No.    | A<br>(max)   | B<br>(max)  | C<br>(max)  | D<br>$\pm .015$<br>$\pm .38$ | E<br>(max)   |
|-------------|--------------|-------------|-------------|------------------------------|--------------|
| 1VR1, 1ER1, | <b>3.35</b>  | <b>1.81</b> | <b>1.16</b> | <b>2.375</b>                 | <b>2.78</b>  |
| 2VR1, 2ER1  | <i>85.1</i>  | <i>46.0</i> | <i>29.5</i> | <i>60.33</i>                 | <i>70.6</i>  |
| 1VR3, 1ER1, | <b>2.07</b>  | <b>1.81</b> | <b>1.16</b> | <b>2.375</b>                 | <b>2.78</b>  |
| 2VR3, 2ER3  | <i>52.6</i>  | <i>46.0</i> | <i>29.5</i> | <i>60.33</i>                 | <i>70.6</i>  |
| 3VR1, 3ER1, | <b>3.85</b>  | <b>2.07</b> | <b>1.16</b> | <b>2.938</b>                 | <b>3.35</b>  |
| 5VR1, 5ER1  | <i>97.8</i>  | <i>52.6</i> | <i>29.5</i> | <i>74.63</i>                 | <i>85.1</i>  |
| 3VR3, 3ER3, | <b>2.56</b>  | <b>2.07</b> | <b>1.16</b> | <b>2.938</b>                 | <b>3.35</b>  |
| 5VR3, 5ER3  | <i>65.0</i>  | <i>52.6</i> | <i>29.5</i> | <i>74.63</i>                 | <i>85.1</i>  |
| 3VR7/7M,    | <b>4.33</b>  | <b>2.25</b> | <b>1.28</b> | <b>1.575</b>                 | <b>0.64*</b> |
| 3ER7/7M     | <i>110.0</i> | <i>57.2</i> | <i>32.5</i> | <i>40.01</i>                 | <i>16.3*</i> |
| 5VR7/7M,    | <b>4.33</b>  | <b>2.25</b> | <b>1.28</b> | <b>1.575</b>                 | <b>0.64*</b> |
| 5ER7/7M     | <i>110.0</i> | <i>57.2</i> | <i>32.5</i> | <i>40.01</i>                 | <i>16.3*</i> |
| 10VR1,      | <b>3.85</b>  | <b>2.07</b> | <b>1.53</b> | <b>2.938</b>                 | <b>3.35</b>  |
| 10ER1       | <i>97.8</i>  | <i>52.6</i> | <i>38.9</i> | <i>74.63</i>                 | <i>85.1</i>  |
| 10VR3,      | <b>2.56</b>  | <b>2.07</b> | <b>1.53</b> | <b>2.938</b>                 | <b>3.35</b>  |
| 10ER3       | <i>65.0</i>  | <i>52.6</i> | <i>38.9</i> | <i>74.63</i>                 | <i>85.1</i>  |
| 10VR6       | <b>3.96</b>  | <b>2.07</b> | <b>1.53</b> | <b>2.938</b>                 | <b>3.35</b>  |
|             | <i>100.6</i> | <i>52.6</i> | <i>38.9</i> | <i>74.63</i>                 | <i>85.1</i>  |
| 10VR7/7M,   | <b>4.33</b>  | <b>2.25</b> | <b>1.53</b> | <b>1.575</b>                 | <b>0.88*</b> |
| 10ER7/7M    | <i>110.0</i> | <i>57.2</i> | <i>38.9</i> | <i>40.01</i>                 | <i>22.4*</i> |
| 20VR1,      | <b>5.23</b>  | <b>3.37</b> | <b>1.53</b> | <b>3.75</b>                  | <b>4.20</b>  |
| 20ER1       | <i>132.8</i> | <i>85.6</i> | <i>38.9</i> | <i>95.25</i>                 | <i>106.7</i> |
| 20VR6       | <b>5.34</b>  | <b>3.37</b> | <b>1.53</b> | <b>3.75</b>                  | <b>4.20</b>  |
|             | <i>135.6</i> | <i>85.6</i> | <i>38.9</i> | <i>95.25</i>                 | <i>406.7</i> |

\* $\pm 0.02$  [0.5]



RFI Power Line Filters

**Two-stage General Purpose RFI Power Line Filter** *(continued)*

# R Series

## Performance Data

### Typical Insertion Loss

Measured in closed 50 Ohm system

**1ER**

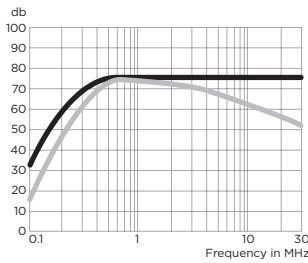

**3ER**



**5ER**



**2ER, 10ER & 20ER**



**1VR**

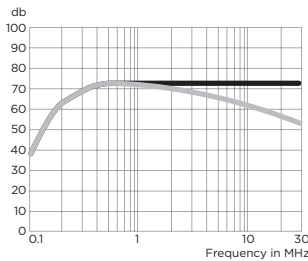

**2VR**



**3VR**



**5VR**



**10VR**

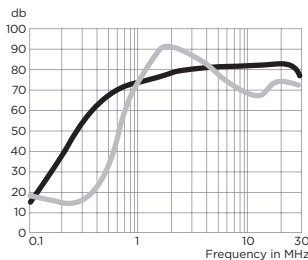

**20VR**



— Common Mode / Asymmetrical (L-G)  
— Differential Mode / Symmetrical (L-L)

### Minimum Insertion Loss

Measured in closed 50 Ohm system

**Common Mode / Asymmetrical (Line to Ground)**

| Current Rating   | Frequency – MHz |    |    |    |    |    |
|------------------|-----------------|----|----|----|----|----|
|                  | .15             | .5 | 1  | 5  | 10 | 30 |
| <b>VR Models</b> |                 |    |    |    |    |    |
| 1A, 3A           | 30              | 65 | 65 | 65 | 65 | 65 |
| 2A, 5A, 10A, 20A | 5               | 44 | 60 | 65 | 65 | 60 |
| <b>ER Models</b> |                 |    |    |    |    |    |
| 1A, 3A           | 25              | 60 | 65 | 65 | 65 | 65 |
| 2A, 5A, 10A, 20A | 2               | 35 | 51 | 63 | 60 | 50 |

**Differential Mode / Symmetrical (Line to Line)**

| Current Rating   | Frequency – MHz |    |    |    |    |    |
|------------------|-----------------|----|----|----|----|----|
|                  | .15             | .5 | 1  | 5  | 10 | 30 |
| <b>VR Models</b> |                 |    |    |    |    |    |
| 1A, 3A           | -               | -  | 65 | 60 | 54 | 46 |
| 2A, 5A, 10A, 20A | -               | -  | 35 | 60 | 57 | 45 |
| <b>ER Models</b> |                 |    |    |    |    |    |
| 1A, 3A           | -               | -  | 65 | 60 | 54 | 46 |
| 2A, 5A, 10A, 20A | -               | -  | 35 | 60 | 57 | 45 |

High Performance Compact Power Line Filter

# RK Series



UL Recognized  
CSA Certified  
VDE Approved



## RK Series

- Compact
- Single stage
- Chassis mount
- Significant differential mode performance
- Suitable for industrial machinery
- Low input leakage current makes it suitable for portable equipment

## Ordering Information



## Available Part Numbers

|        |        |
|--------|--------|
| 3ERK1  | 6ERK1  |
| 10ERK1 | 15ERK1 |
| 20ERK1 |        |

## Specifications

### Maximum leakage current each Line to Ground:

|                  |         |
|------------------|---------|
| @ 120 VAC 60 Hz: | 0.16 mA |
| @250 VAC 50 Hz:  | 0.26 mA |

### Hipot rating (one minute):

|                 |          |
|-----------------|----------|
| Line to Ground: | 2250 VDC |
| Line to Line:   | 1450 VDC |

### Rated Voltage (max):

250 VAC

### Operating Frequency:

50/60 Hz

### Rated Current:

3 to 20A

### Operating Ambient Temperature Range

(at rated current  $I_r$ ): -10°C to +40°C  
In an ambient temperature ( $T_a$ ) higher than +40°C the maximum operating current ( $I_o$ ) is calculated as follows:  $I_o = I_r \sqrt{(85-T_a)/45}$

## Electrical Schematic

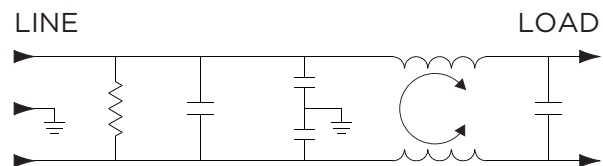

**High Performance Compact Power Line Filter** *(continued)*

# RK Series

## Case Styles

### RK1 (3 & 6A)



### RK1 (10, 15 & 20A)



Typical Dimensions:

- Line/Load Terminals (4): .250 [6.3] with .07 [1.8] Dia. hole
- Ground Terminal (1): .250 [6.3] with .07 x .16 [1.8 x 3.8] slot
- Mounting Holes (2): .188 [4.78] Dia.

## Case Dimensions

| Part No.                  | A<br>(max)                  | B<br>(max)                  | C<br>(max)                  | D<br>$\pm .015$<br>$\pm .38$ | E<br>(max)                  |
|---------------------------|-----------------------------|-----------------------------|-----------------------------|------------------------------|-----------------------------|
| 3ERK1                     | <b>3.35</b><br><i>85.09</i> | <b>1.82</b><br><i>46.23</i> | <b>1.16</b><br><i>29.46</i> | <b>2.38</b><br><i>74.68</i>  | <b>2.78</b><br><i>70.61</i> |
| 6ERK1                     | <b>3.35</b><br><i>85.09</i> | <b>1.82</b><br><i>46.23</i> | <b>1.28</b><br><i>32.51</i> | <b>2.38</b><br><i>74.68</i>  | <b>2.78</b><br><i>70.61</i> |
| 10ERK1, 15ERK1,<br>20ERK1 | <b>3.85</b><br><i>97.79</i> | <b>2.07</b><br><i>52.58</i> | <b>1.78</b><br><i>45.21</i> | <b>2.94</b><br><i>74.67</i>  | <b>3.35</b><br><i>85.09</i> |

High Performance Compact Power Line Filter *(continued)*

# RK Series

## Performance Data

### Typical Insertion Loss

Measured in closed 50 Ohm system

3RK



6RK



10RK



15RK



20RK



— Common Mode / Asymmetrical (L-G)  
— Differential Mode / Symmetrical (L-L)

### Minimum Insertion Loss

Common Mode / Asymmetrical (Line to Ground)

| Current Rating | Frequency – MHz |     |     |    |    |    |    |    |    |    |
|----------------|-----------------|-----|-----|----|----|----|----|----|----|----|
|                | .05             | .10 | .15 | .5 | 1  | 2  | 5  | 10 | 20 | 30 |
| 3A             | 21              | 27  | 30  | 43 | 49 | 50 | 50 | 48 | 50 | 49 |
| 6A             | 19              | 29  | 29  | 37 | 43 | 44 | 48 | 46 | 50 | 48 |
| 10A            | 20              | 27  | 31  | 45 | 45 | 44 | 46 | 47 | 53 | 44 |
| 15A            | 21              | 28  | 31  | 45 | 43 | 41 | 42 | 42 | 47 | 57 |
| 20A            | 19              | 25  | 29  | 34 | 36 | 38 | 40 | 41 | 43 | 52 |

Differential Mode / Symmetrical (Line to Line)

| Current Rating | Frequency – MHz |     |     |    |    |    |    |    |    |    |
|----------------|-----------------|-----|-----|----|----|----|----|----|----|----|
|                | .05             | .10 | .15 | .5 | 1  | 2  | 5  | 10 | 20 | 30 |
| 3A             | 9               | 20  | 35  | 67 | 78 | 78 | 72 | 66 | 61 | 60 |
| 6A             | 14              | 14  | 13  | 59 | 74 | 80 | 72 | 68 | 61 | 60 |
| 10A            | 14              | 12  | 30  | 65 | 80 | 84 | 78 | 70 | 60 | 50 |
| 15A            | 15              | 13  | 20  | 61 | 76 | 88 | 70 | 72 | 64 | 50 |
| 20A            | 16              | 19  | 16  | 54 | 74 | 90 | 74 | 67 | 61 | 54 |

**Multipurpose Power Line RFI Filter for Emission Control**

# S Series



UL Recognized  
CSA Certified  
VDE Approved



## S Series

- Combines Line to Ground interference rejection filters with additional circuitry to reduce Line to Line noise and transients
- Designed for use when equipment impedance at RF frequencies is high
- Effective for use with switch-mode power supplies
- Effective when used to control emissions in equipment using SCR and T2L circuits for compliance with FCC Part 15, Subpart J and EN55022, Level A, down to 150kHz

## Ordering Information

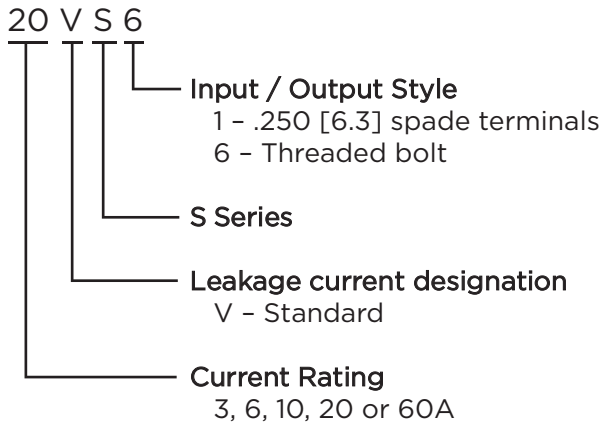

## Available Part Numbers

|       |       |
|-------|-------|
| 3VS1  | 20VS1 |
| 6VS1  | 20VS6 |
| 10VS1 | 60VS6 |

## Specifications

### Maximum leakage current each Line to Ground:

|                 |                    |            |
|-----------------|--------------------|------------|
|                 | <u>3 &amp; 20A</u> | <u>60A</u> |
| @120 VAC 60 Hz: | .4 mA              | .75 mA     |
| @250 VAC 50 Hz: | .7 mA              | 1.25 mA    |

### Hipot rating (one minute):

|                 |          |
|-----------------|----------|
| Line to Ground: | 2250 VDC |
| Line to Line:   | 1450 VDC |

### Rated Voltage (max):

250 VAC

### Operating Frequency:

50/60 Hz

### Rated Current:

3 to 60A

### Operating Ambient Temperature Range

(at rated current  $I_r$ ): -10°C to +40°C

In an ambient temperature ( $T_a$ ) higher than +40°C the maximum operating current ( $I_o$ ) is calculated as follows:  $I_o = I_r \sqrt{(85-T_a)/45}$

## Electrical Schematics

### 3, 6, 10VS

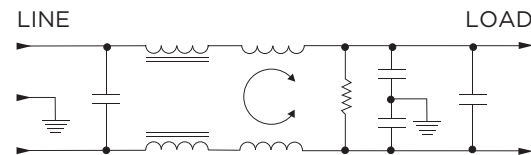

### 20VS

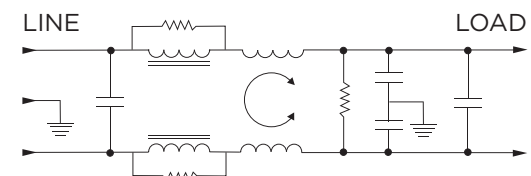

### 60VS

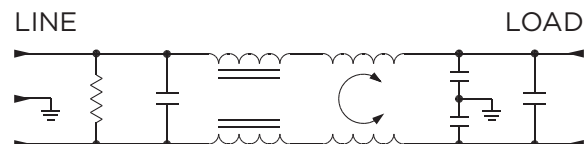

**Multipurpose Power Line RFI Filter for Emission Control** *(continued)*

# S Series

## Case Styles

### S1 (3, 6, 10A)



Typical Dimensions:

- Line/Load Terminals (4): .250 [6.3] with .07 [1.8] Dia. hole
- Ground Terminal (1): .250 [6.3] with .07 x .16 [1.8 x 3.8] slot
- Mounting Holes (2): .188 [4.78] Dia.

### 20VS1



Typical Dimensions:

- Line/Load Terminals (4): .250 [6.3] with .07 [1.8] Dia. hole
- Ground Terminal (1): .250 [6.3] with .07 x .16 [1.8 x 3.8] slot
- Mounting Slots (4): .250 x .156 [6.35 x 3.96] Dia.

### 20VS6



Typical Dimensions:

- Terminals (5): 8-32, Torque 18 lbf-in. [2.03 N-m] max. ± 2 [.22]
- Mounting Slots (4): .250 x .156 [6.35 x 3.96] Dia.

### 60VS6



Typical Dimensions:

- Terminals (5): 1/4-20, Torque 56 lbf-in. [6.32 N-m] max. ± 2 [.22]
- Mounting Holes (5): .218 [5.53] Dia. ± .006 [.152]

## Case Dimensions

| Part No. | A<br>(max)           | B<br>(max)           | C<br>(max)           | D<br>$\pm .015$<br>$\pm .38$ | E<br>(max)            |
|----------|----------------------|----------------------|----------------------|------------------------------|-----------------------|
| 3VS1     | <b>3.36</b><br>85.3  | <b>1.82</b><br>46.2  | <b>1.16</b><br>29.5  | <b>2.375</b><br>60.33        | <b>2.78</b><br>70.6   |
| 6VS1     | <b>3.86</b><br>98.0  | <b>2.08</b><br>52.8  | <b>1.53</b><br>38.9  | <b>2.938</b><br>74.63        | <b>3.34</b><br>84.8   |
| 10VS1    | <b>3.86</b><br>98.0  | <b>2.08</b><br>52.8  | <b>1.53</b><br>38.9  | <b>2.938</b><br>74.63        | <b>3.34</b><br>84.8   |
| 20VS1    | <b>5.23</b><br>132.8 | <b>3.38</b><br>85.9  | <b>1.53</b><br>38.9  | <b>3.75</b><br>95.25         | <b>4.20</b><br>106.7  |
| 20VS6    | <b>5.34</b><br>135.6 | <b>3.38</b><br>85.9  | <b>1.53</b><br>38.9  | <b>3.75</b><br>95.25         | <b>4.20</b><br>106.7  |
| 60VS6    | <b>7.2</b><br>182.88 | <b>3.08</b><br>78.23 | <b>2.28</b><br>57.91 | <b>5.625</b><br>142.87       | <b>6.25</b><br>158.75 |



RFI Power Line Filters

**Multipurpose Power Line RFI Filter for Emission Control** *(continued)*

# S Series

## Performance Data

### Typical Insertion Loss

Measured in closed 50 Ohm system

**3VS**



**6VS**



**10VS**



**20VS**



**60VS**



— Common Mode / Asymmetrical (L-G)  
— Differential Mode / Symmetrical (L-L)

### Minimum Insertion Loss

Measured in closed 50 Ohm system

Common Mode / Asymmetrical (Line to Ground)

| Current Rating | Frequency – MHz |    |    |    |    |    |    |    |
|----------------|-----------------|----|----|----|----|----|----|----|
|                | .15             | .5 | 1  | 2  | 5  | 10 | 20 | 30 |
| 3A             | 15              | 27 | 35 | 40 | 32 | 44 | 47 | 47 |
| 6A             | 15              | 27 | 35 | 40 | 32 | 44 | 47 | 47 |
| 10A            | 15              | 27 | 35 | 40 | 32 | 44 | 47 | 47 |
| 20A            | 15              | 30 | 38 | 38 | 32 | 43 | 42 | 40 |
| 60A            | 7               | 27 | 34 | 38 | 45 | 54 | 44 | 40 |

Differential Mode / Symmetrical (Line to Line)

| Current Rating | Frequency – MHz |    |    |    |    |    |    |    |    |
|----------------|-----------------|----|----|----|----|----|----|----|----|
|                | .15             | .3 | .5 | 1  | 2  | 5  | 10 | 20 | 30 |
| 3A             | 35              | 50 | 65 | 65 | 65 | 60 | 50 | 40 | 45 |
| 6A             | 35              | 50 | 65 | 65 | 65 | 60 | 45 | 48 | 48 |
| 10A            | 35              | 50 | 65 | 65 | 65 | 60 | 50 | 40 | 45 |
| 20A            | 35              | 50 | 65 | 65 | 65 | 60 | 45 | 48 | 48 |
| 60A            | 37              | -  | 77 | 93 | 86 | 70 | 54 | 64 | 54 |



High Performance B Series RFI Line Filters

# SB Series



UL Recognized  
CSA Certified  
VDE Approved



## SB Series

- Enhanced performance version of our popular B Series of RFI line filters
- Small size with enhanced performance
- 30A version half the size of other 30A filters
- Low leakage version available that meets current requirements of VDE portable equipment and non-patient care medical equipment

## Ordering Information



## Electrical Schematic



## Specifications

### Maximum leakage current each Line to Ground:

|                  | VSB Models | ESB Models |
|------------------|------------|------------|
| @ 120 VAC 60 Hz: | .75 mA     | .22 mA     |
| @ 250 VAC 50 Hz: | 1.25 mA    | .36 mA     |

### Hipot rating (one minute):

|                 |          |
|-----------------|----------|
| Line to Ground: | 2250 VDC |
| Line to Line:   | 1450 VDC |

### Rated Voltage (max):

|         |
|---------|
| 250 VAC |
| 250 VDC |

### Operating Frequency:

50/60 Hz

### Rated Current:

6 to 30A

### Operating Ambient Temperature Range

(at rated current  $I_r$ ): -10°C to +40°C  
In an ambient temperature ( $T_a$ ) higher than +40°C the maximum operating current ( $I_o$ ) is calculated as follows:  $I_o = I_r \sqrt{(85-T_a)/45}$

## Available Part Numbers

|        |        |
|--------|--------|
| 6ESB1  | 6VSB1  |
| 10ESB1 | 10VSB1 |
| 10ESB6 | 10VSB6 |
| 20ESB1 | 20VSB1 |
| 20ESB6 | 20VSB6 |
| 30ESB6 | 30VSB6 |

High Performance B Series RFI Line Filters *(continued)*

# SB Series

## Case Styles

### 6ESB1 & 6VSB1



Typical Dimensions:

- Line/Load Terminals (4): .250 [6.3] with .07 [1.8] Dia. hole
- Ground Terminal (1): .250 [6.3] with .07 x .16 [1.8 x 3.8] slot
- Mounting Holes (2): .188 [4.75] Dia.

### 10ESB1, 10VSB1, 20ESB1 & 20VSB1



Typical Dimensions:

- Line/Load Terminals (4): .250 [6.3] with .07 [1.8] Dia. hole
- Ground Terminal (1): .250 [6.3] with .07 x .16 [1.8 x 3.8] slot
- Mounting Holes (2): .188 [4.75] Dia.

### ESB6 & VSB6



Typical Dimensions:

- Terminals (5): 8-32, Torque 18 lbf-in. [2.03 N-m] max. ± 2 [22]
- Mounting Holes (2): .188 [4.75] Dia.

## Case Dimensions

| Part No. | A<br>(max)    | B<br>(max)   | C<br>(max)   | D<br>$\pm .015$<br>$\pm .38$ | E<br>(max)    |
|----------|---------------|--------------|--------------|------------------------------|---------------|
| 6ESB1,   | <b>3.36</b>   | <b>1.82</b>  | <b>0.91</b>  | <b>2.375</b>                 | <b>2.78</b>   |
| 6VSB1    | <i>85.34</i>  | <i>46.23</i> | <i>23.11</i> | <i>60.325</i>                | <i>70.61</i>  |
| 10ESB1,  | <b>3.36</b>   | <b>1.82</b>  | <b>1.28</b>  | <b>2.375</b>                 | <b>2.78</b>   |
| 10VSB1   | <i>85.34</i>  | <i>46.23</i> | <i>32.51</i> | <i>60.325</i>                | <i>70.61</i>  |
| 10ESB6,  | <b>3.47</b>   | <b>1.82</b>  | <b>1.53</b>  | <b>2.375</b>                 | <b>2.78</b>   |
| 10VSB6   | <i>88.14</i>  | <i>46.23</i> | <i>38.86</i> | <i>60.325</i>                | <i>70.61</i>  |
| 20ESB1,  | <b>3.85</b>   | <b>2.07</b>  | <b>1.31</b>  | <b>2.938</b>                 | <b>3.35</b>   |
| 20VSB1   | <i>97.79</i>  | <i>52.58</i> | <i>33.27</i> | <i>74.625</i>                | <i>85.09</i>  |
| 20ESB6,  | <b>4.00</b>   | <b>2.07</b>  | <b>1.53</b>  | <b>2.938</b>                 | <b>3.35</b>   |
| 20VSB6   | <i>101.60</i> | <i>52.58</i> | <i>38.86</i> | <i>74.625</i>                | <i>85.09</i>  |
| 30ESB6,  | <b>4.92</b>   | <b>2.07</b>  | <b>1.53</b>  | <b>3.947</b>                 | <b>4.33</b>   |
| 30VSB6   | <i>124.97</i> | <i>52.58</i> | <i>38.86</i> | <i>100.254</i>               | <i>109.98</i> |

High Performance B Series RFI Line Filters *(continued)*

# SB Series

## Performance Data

### Typical Insertion Loss

Measured in closed 50 Ohm system

### ESB Models

**6ESB1**



**10ESB1**



**10ESB6**



**20ESB1**



**20ESB6**



**30ESB6**



### VSB Models

**6VSB1**

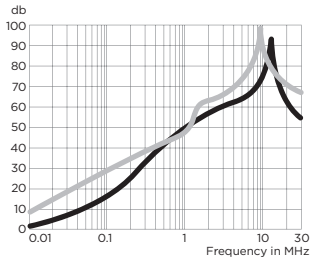

**10VSB1**

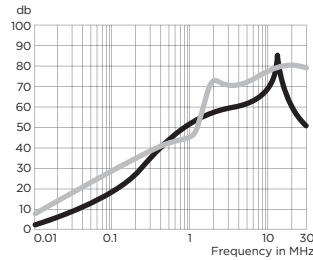

**10VSB6**

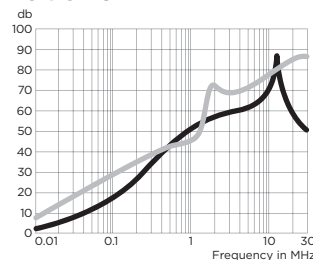

**20VSB1**

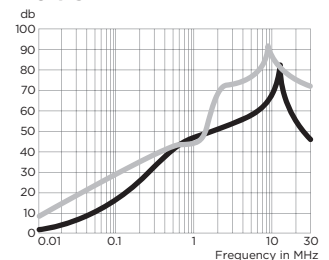

**20VSB6**



**30VSB6**



— Common Mode / Asymmetrical (L-G)  
— Differential Mode / Symmetrical (L-L)

**High Performance B Series RFI Line Filters** *(continued)*

# SB Series

## Performance Data *(continued)*

### Minimum Insertion Loss

Measured in closed 50 Ohm system

Common Mode / Asymmetrical (Line to Ground)

| Part No.          | Frequency – MHz |     |    |     |    |    |    |    |    |    |    |
|-------------------|-----------------|-----|----|-----|----|----|----|----|----|----|----|
|                   | .03             | .05 | .1 | .15 | .5 | 1  | 2  | 5  | 10 | 20 | 30 |
| <b>ESB Models</b> |                 |     |    |     |    |    |    |    |    |    |    |
| 6ESB1             | 3               | 8   | 13 | 17  | 31 | 37 | 40 | 47 | 50 | 58 | 62 |
| 10ESB1            | 3               | 9   | 15 | 19  | 31 | 39 | 41 | 44 | 47 | 54 | 51 |
| 10ESB6            | 3               | 9   | 14 | 18  | 31 | 39 | 41 | 44 | 47 | 54 | 54 |
| 20ESB1            | 3               | 7   | 13 | 15  | 30 | 35 | 37 | 39 | 40 | 46 | 40 |
| 20ESB6            | 3               | 7   | 13 | 16  | 30 | 35 | 39 | 40 | 44 | 58 | 46 |
| 30ESB6            | 3               | 7   | 13 | 17  | 30 | 34 | 37 | 40 | 42 | 49 | 58 |
| <b>VSB Models</b> |                 |     |    |     |    |    |    |    |    |    |    |
| 6VSB1             | 3               | 8   | 14 | 19  | 37 | 47 | 51 | 58 | 66 | 59 | 49 |
| 10VSB1            | 3               | 9   | 15 | 21  | 41 | 49 | 50 | 56 | 64 | 54 | 46 |
| 10VSB6            | 4               | 9   | 15 | 21  | 39 | 49 | 50 | 56 | 64 | 54 | 44 |
| 20VSB1            | 3               | 7   | 14 | 19  | 37 | 45 | 47 | 50 | 60 | 48 | 40 |
| 20VSB6            | 3               | 7   | 14 | 19  | 37 | 44 | 49 | 52 | 62 | 48 | 41 |
| 30VSB6            | 3               | 6   | 13 | 18  | 37 | 45 | 49 | 51 | 60 | 50 | 42 |

Differential Mode / Symmetrical (Line to Line)

| Part No.          | Frequency – MHz |     |     |    |     |    |    |    |    |    |    |    |
|-------------------|-----------------|-----|-----|----|-----|----|----|----|----|----|----|----|
|                   | .01             | .03 | .05 | .1 | .15 | .5 | 1  | 2  | 5  | 10 | 20 | 30 |
| <b>ESB Models</b> |                 |     |     |    |     |    |    |    |    |    |    |    |
| 6ESB1             | 5               | 14  | 20  | 25 | 29  | 41 | 49 | 47 | 50 | 60 | 74 | 72 |
| 10ESB1            | 5               | 15  | 20  | 26 | 29  | 41 | 47 | 50 | 54 | 64 | 74 | 74 |
| 10ESB6            | 5               | 14  | 20  | 25 | 29  | 41 | 47 | 48 | 50 | 60 | 62 | 64 |
| 20ESB1            | 5               | 15  | 21  | 26 | 29  | 41 | 45 | 48 | 54 | 63 | 70 | 66 |
| 20ESB6            | 5               | 15  | 21  | 26 | 29  | 41 | 44 | 48 | 54 | 63 | 70 | 66 |
| 30ESB6            | 5               | 14  | 20  | 25 | 29  | 40 | 46 | 50 | 50 | 58 | 70 | 70 |
| <b>VSB Models</b> |                 |     |     |    |     |    |    |    |    |    |    |    |
| 6VSB1             | 5               | 14  | 20  | 25 | 29  | 40 | 41 | 57 | 66 | 78 | 56 | 62 |
| 10VSB1            | 5               | 15  | 21  | 26 | 29  | 39 | 40 | 60 | 64 | 67 | 67 | 64 |
| 10VSB6            | 5               | 14  | 20  | 25 | 29  | 39 | 40 | 60 | 64 | 68 | 70 | 64 |
| 20VSB1            | 5               | 15  | 20  | 26 | 29  | 40 | 42 | 60 | 68 | 70 | 70 | 67 |
| 20VSB6            | 5               | 15  | 21  | 26 | 29  | 39 | 38 | 58 | 68 | 70 | 70 | 66 |
| 30VSB6            | 5               | 15  | 20  | 25 | 29  | 39 | 39 | 56 | 62 | 70 | 70 | 66 |

High Performance K Series RFI Line Filters for SMPS Emission Control

# SK Series



UL Recognized  
CSA Certified  
VDE Approved



## SK Series

- Designed to reduce conducted noise to acceptable limits for equipment that must comply with FCC / EN specifications
- Utilizes significantly higher element values than the general purpose K Series which makes them better suited for equipment with Line to Ground and Line to Line conducted emissions including those with switching power supplies
- ESK6C and VSK6C incorporate separate ground circuit inductor to isolate the equipment chassis from power line ground at RF frequencies

## Ordering Information



\*IEC 60320-1 C14 inlet mates with C13 connector

## Specifications

### Maximum leakage current each Line to Ground:

|                         | VSK Models | ESK Models |
|-------------------------|------------|------------|
| <b>3, 6 &amp; 10A</b>   |            |            |
| @120 VAC 60 Hz:         | .4 mA      | .21 mA     |
| @250 VAC 50 Hz:         | .7 mA      | .36 mA     |
| <b>20, 30 &amp; 40A</b> |            |            |
| @120 VAC 60 Hz:         | .75 mA     | .3 mA      |
| @250 VAC 50 Hz:         | 1.25 mA    | .5 mA      |

### Hipot rating (one minute):

|                 |          |
|-----------------|----------|
| Line to Ground: | 2250 VDC |
| Line to Line:   | 1450 VDC |

### Rated Voltage (max):

250 VAC

### Operating Frequency:

50/60 Hz

### Rated Current:

3 to 40A

### Operating Ambient Temperature Range

(at rated current  $I_r$ ): -10°C to +40°C  
In an ambient temperature ( $T_a$ ) higher than +40°C the maximum operating current ( $I_o$ ) is calculated as follows:  $I_o = I_r \sqrt{(85-T_a)/45}$

## Available Part Numbers

|         |         |         |
|---------|---------|---------|
| 3VSK1   | 3ESK1   | 20ESK6  |
| 3VSK3   | 3ESK3   | 20VSK6  |
| 3VSK7   | 3ESK7   | 30ESK6  |
| 3VSK7M  | 3ESK7M  | 30ESK6C |
| 6VSK1   | 6ESK1   | 30VSK6  |
| 6VSK3   | 6ESK3   | 30VSK6C |
| 6VSK7   | 6ESK7   | 40VSK6  |
| 6VSK7M  | 6ESK7M  |         |
| 10VSK1  | 10ESK1  |         |
| 10VSK3  | 10ESK3  |         |
| 10VSK7  | 10ESK7  |         |
| 10VSK7M | 10ESK7M |         |



High Performance K Series Filters for SMPS Emission Control *(continued)*

# SK Series

## Electrical Schematic



## Accessories

GA400: NEMA 5-15P to IEC 60320-1 C-13 line cord



## Case Styles

### SK1

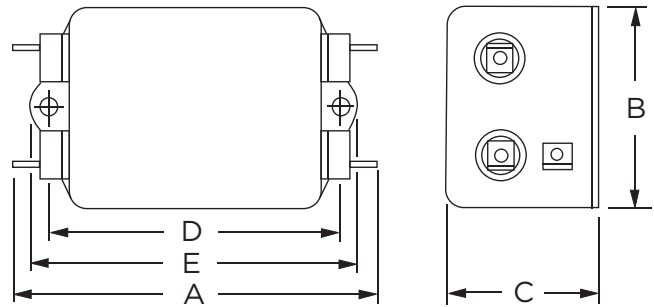

Typical Dimensions:  
 Line/Load Terminals (4): .250 [6.3] with .07 [1.8] Dia. hole  
 Ground Terminal (1): .250 [6.3] with .07 x .16 [1.8 x 3.8] slot  
 Mounting Holes (2): .188 [4.78] Dia.

### SK3 (3A)

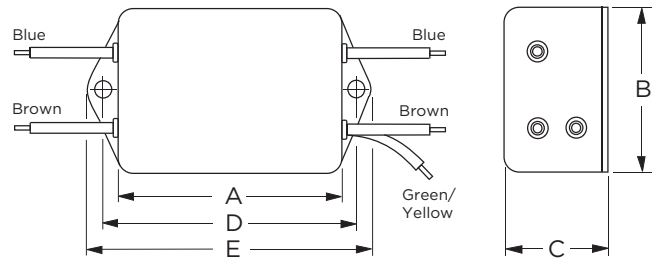

Typical Dimensions:  
 Wire Leads (5): 4.0 [101.6] Min., AWG18  
 Mounting Holes (2): .188 [4.78] Dia.

### SK3 (6 & 10A)

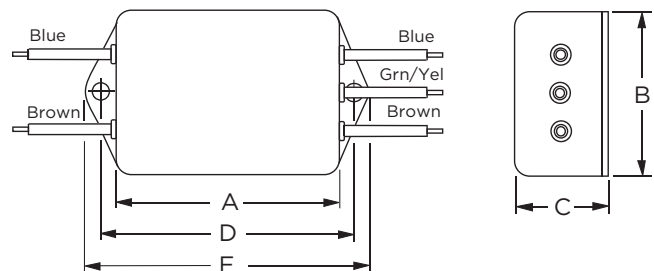

Typical Dimensions:  
 Wire Leads (5): 4.0 [101.6] Min., AWG18 (AWG16 for 10A)  
 Mounting Holes (2): .188 [4.78] Dia.

High Performance K Series Filters for SMPS Emission Control *(continued)*

# SK Series

## Case Styles *(continued)*

### SK6 (20A)



Typical Dimensions:  
 Terminals (5): 8-32, Torque 18 lbf-in. [2.03 N-m] max. ± 2 [.22]  
 Mounting Holes (2): .188 [4.78] Dia.

### SK6 (30A)



Typical Dimensions:  
 Terminals (5): 10-32, Torque 27 lbf-in. [3.05 N-m] max. ± 2 [.22]  
 Mounting Slots (4): .250 x .156 [6.35 x 3.96] Dia.

### SK6C (30A)



Typical Dimensions:  
 Terminals (5): 10-32, Torque 27 lbf-in. [3.05 N-m] max. ± 2 [.22]  
 Mounting Slots (4): .250 x .156 [6.35 x 3.96] Dia.

### SK6 (40A)



Typical Dimensions:  
 Terminals (5): 10-32, Torque 27 lbf-in. [3.05 N-m] max. ± 2 [.22]  
 Mounting Slots (4): .203 x .156 [5.15 x 3.96] Dia.

### SK7 & SK7M



Typical Dimensions:  
 Load Terminals (2): .250 [6.3] with .07 [1.8] Dia. hole  
 Ground Terminal (1): .250 [6.3] with .07 x .16 [1.8 x 3.8] slot  
 Line Inlet (1): IEC 60320-1 C14  
 K7 Tapped Inserts (2): 6-32 x 1/4  
 K7M Tapped Inserts (2): M3 x .5

### Recommended Panel Cutout



Tolerance ± .005 [0.13]  
 Back Mount Only



RFI Power Line Filters

High Performance K Series Filters for SMPS Emission Control *(continued)*

# SK Series

## Case Dimensions

| Part No.   | A<br>(max)    | B<br>(max)   | C<br>(max)   | D<br>$\pm 0.15$<br>$\pm .38$ | E<br>(max)   |
|------------|---------------|--------------|--------------|------------------------------|--------------|
| 3VSK1,     | <b>3.85</b>   | <b>2.07</b>  | <b>1.16</b>  | <b>2.938</b>                 | <b>3.35</b>  |
| 3ESK1      | <i>97.8</i>   | <i>52.6</i>  | <i>29.5</i>  | <i>74.63</i>                 | <i>85.1</i>  |
| 3VSK3,     | <b>2.56</b>   | <b>2.07</b>  | <b>1.16</b>  | <b>2.938</b>                 | <b>3.35</b>  |
| 3ESK3      | <i>65.0</i>   | <i>52.6</i>  | <i>29.5</i>  | <i>74.63</i>                 | <i>85.1</i>  |
| 3VSK7/7M,  | <b>3.21</b>   | <b>2.25</b>  | <b>1.53</b>  | <b>1.575</b>                 | <b>0.63*</b> |
| 3ESK7/7M   | <i>81.5</i>   | <i>57.2</i>  | <i>38.9</i>  | <i>40.01</i>                 | <i>16.0*</i> |
| 6VSK1,     | <b>4.34</b>   | <b>2.25</b>  | <b>1.28</b>  | <b>3.427</b>                 | <b>3.83</b>  |
| 6ESK1      | <i>110.2</i>  | <i>57.2</i>  | <i>32.5</i>  | <i>87.05</i>                 | <i>97.3</i>  |
| 6VSK3,     | <b>3.05</b>   | <b>2.25</b>  | <b>1.28</b>  | <b>3.427</b>                 | <b>3.83</b>  |
| 6ESK3      | <i>77.5</i>   | <i>57.2</i>  | <i>32.5</i>  | <i>87.05</i>                 | <i>97.3</i>  |
| 6VSK7/7M,  | <b>3.21</b>   | <b>2.25</b>  | <b>1.78</b>  | <b>1.575</b>                 | <b>0.63*</b> |
| 6ESK7/7M   | <i>81.5</i>   | <i>57.2</i>  | <i>45.2</i>  | <i>40.01</i>                 | <i>16.0*</i> |
| 10VSK1,    | <b>4.97</b>   | <b>2.25</b>  | <b>1.78</b>  | <b>4.063</b>                 | <b>4.46</b>  |
| 10ESK1     | <i>126.2</i>  | <i>57.2</i>  | <i>45.2</i>  | <i>103.2</i>                 | <i>113.3</i> |
| 10VSK3,    | <b>3.69</b>   | <b>2.25</b>  | <b>1.78</b>  | <b>4.063</b>                 | <b>4.46</b>  |
| 10ESK3     | <i>93.7</i>   | <i>57.2</i>  | <i>45.2</i>  | <i>103.2</i>                 | <i>113.3</i> |
| 10VSK7/7M, | <b>4.34</b>   | <b>2.25</b>  | <b>1.78</b>  | <b>1.575</b>                 | <b>0.63*</b> |
| 10ESK7/7M  | <i>110.0</i>  | <i>57.2</i>  | <i>45.2</i>  | <i>40.01</i>                 | <i>16.0*</i> |
| 20VSK6,    | <b>5.09</b>   | <b>2.25</b>  | <b>1.78</b>  | <b>4.063</b>                 | <b>4.46</b>  |
| 20ESK6     | <i>127.3</i>  | <i>57.2</i>  | <i>45.2</i>  | <i>103.2</i>                 | <i>129.3</i> |
| Part No.   | A<br>(max)    | B<br>(max)   | C<br>(max)   | D<br>$\pm 0.20$<br>$\pm .51$ | E<br>(max)   |
| 30VSK6,    | <b>4.92</b>   | <b>3.12</b>  | <b>2.75</b>  | <b>3.437</b>                 | <b>4.00</b>  |
| 30ESK6     | <i>125.0</i>  | <i>79.25</i> | <i>69.85</i> | <i>87.3</i>                  | <i>101.6</i> |
| 30VSK6C,   | <b>4.92</b>   | <b>3.12</b>  | <b>2.75</b>  | <b>3.437</b>                 | <b>4.00</b>  |
| 30ESK6C    | <i>125.0</i>  | <i>79.25</i> | <i>69.85</i> | <i>87.3</i>                  | <i>101.6</i> |
| 40VSK6     | <b>6.45</b>   | <b>3.12</b>  | <b>2.18</b>  | <b>3.50</b>                  | <b>3.96</b>  |
|            | <i>163.83</i> | <i>79.25</i> | <i>55.4</i>  | <i>88.9</i>                  | <i>100.6</i> |

\*±0.02 [0.5]

## Performance Data

### Typical Insertion Loss

Measured in closed 50 Ohm system

#### 3 & 6VSK

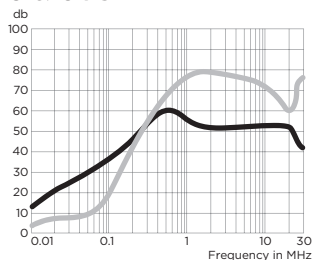

#### 3 & 6ESK

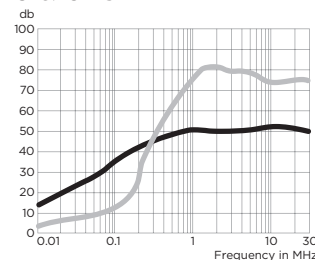

#### 10 & 20VSK

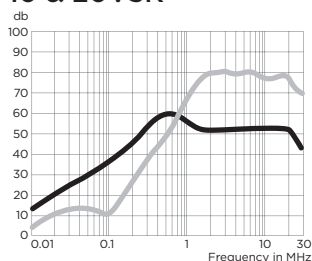

#### 10 & 20ESK

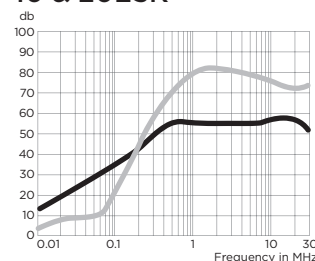

#### 30VSK

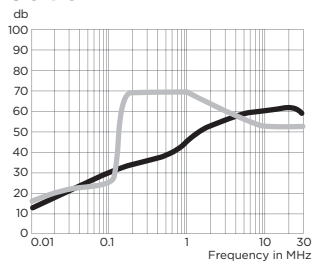

#### 30ESK

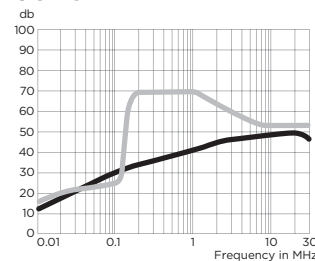

#### 40VSK

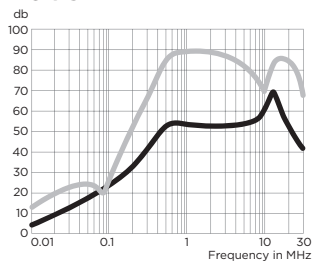

— Common Mode / Asymmetrical (L-G)  
- - - Differential Mode / Symmetrical (L-L)



**High Performance K Series Filters for SMPS Emission Control** *(continued)*

# SK Series

## Performance Data *(continued)*

### Minimum Insertion Loss

Measured in closed 50 Ohm system

Common Mode / Asymmetrical (Line to Ground)

| Current Rating    | Frequency – MHz |     |    |     |    |    |    |    |    |
|-------------------|-----------------|-----|----|-----|----|----|----|----|----|
|                   | .01             | .08 | .1 | .15 | .5 | 1  | 5  | 10 | 30 |
| <b>VSK Models</b> |                 |     |    |     |    |    |    |    |    |
| 3A, 6A            | 4               | 23  | 25 | 29  | 43 | 44 | 42 | 42 | 30 |
| 10A               | 4               | 23  | 25 | 29  | 43 | 44 | 42 | 42 | 30 |
| 20A               | 7               | 23  | 25 | 29  | 43 | 44 | 48 | 48 | 48 |
| 30A               | 2               | 13  | 14 | 15  | 27 | 31 | 46 | 51 | 39 |
| 40A               | 2               | 15  | 18 | 22  | 40 | 43 | 45 | 50 | 30 |
| <b>ESK Models</b> |                 |     |    |     |    |    |    |    |    |
| 3A, 6A            | 4               | 22  | 24 | 28  | 42 | 40 | 36 | 36 | 27 |
| 10A               | 4               | 22  | 24 | 28  | 42 | 40 | 36 | 36 | 27 |
| 20A               | 7               | 22  | 24 | 28  | 35 | 38 | 45 | 45 | 45 |
| 30A               | 2               | 13  | 15 | 15  | 27 | 31 | 40 | 41 | 36 |

Differential Mode / Symmetrical (Line to Line)

| Current Rating    | Frequency – MHz |     |    |     |    |    |    |    |    |
|-------------------|-----------------|-----|----|-----|----|----|----|----|----|
|                   | .01             | .08 | .1 | .15 | .5 | 1  | 5  | 10 | 30 |
| <b>VSK Models</b> |                 |     |    |     |    |    |    |    |    |
| 3A, 6A            | 1               | 3   | 10 | 25  | 59 | 65 | 62 | 40 | 40 |
| 10A               | 1               | 3   | 3  | 10  | 55 | 65 | 65 | 50 | 50 |
| 20A               | 1               | 10  | 8  | 8   | 45 | 60 | 65 | 60 | 60 |
| 30A               | 5               | 13  | 13 | 13  | 60 | 60 | 51 | 43 | 43 |
| 40A               | 7               | 14  | 16 | 30  | 65 | 65 | 65 | 57 | 50 |
| <b>ESK Models</b> |                 |     |    |     |    |    |    |    |    |
| 3A, 6A            | 1               | 3   | 10 | 25  | 59 | 65 | 62 | 40 | 40 |
| 10A               | 1               | 3   | 3  | 10  | 55 | 65 | 65 | 65 | 45 |
| 20A               | 1               | 10  | 8  | 8   | 45 | 60 | 65 | 60 | 60 |
| 30A               | 5               | 12  | 12 | 13  | 60 | 60 | 51 | 43 | 43 |



**High Performance RFI Power Line Filters for Switching Power Supplies**

# T Series



UL Recognized  
CSA Certified  
VDE Approved



## T Series

- Superior common-mode and premium differential-mode attenuation
- Smaller package sizes than the EP Series
- Size and cost-effective
- ET models can help meet very low leakage current requirements

## Ordering Information



\*IEC 60320-1 C14 inlet mates with C13 connector

## Specifications

### Maximum leakage current each Line to Ground:

|                       | ET Models | VT Models |
|-----------------------|-----------|-----------|
| <b>3, 6 &amp; 10A</b> |           |           |
| @120 VAC 60 Hz:       | .30 mA    | .75 mA    |
| @250 VAC 50 Hz:       | .50 mA    | 1.2 mA    |
| <b>15 &amp; 20A</b>   |           |           |
| @120 VAC 60 Hz:       | .30 mA    | 1.2 mA    |
| @250 VAC 50 Hz:       | .50 mA    | 2.0 mA    |

### Hipot rating (one minute):

|                 |          |
|-----------------|----------|
| Line to Ground: | 2250 VDC |
| Line to Line:   | 1450 VDC |

**Rated Voltage (max):** 250 VAC

**Operating Frequency:** 50/60 Hz

**Rated Current:** 3 to 20A

### Operating Ambient Temperature Range

(at rated current  $I_r$ ): -10°C to +40°C  
In an ambient temperature ( $T_a$ ) higher than +40°C the maximum operating current ( $I_o$ ) is calculated as follows:  $I_o = I_r \sqrt{(85-T_a)/45}$

## Available Part Numbers

|      |       |       |
|------|-------|-------|
| 3ET1 | 10ET1 | 10VT1 |
| 3ET3 | 10ET3 | 10VT3 |
| 3ET7 | 15ET1 | 15VT1 |
| 6ET1 | 15ET6 | 15VT6 |
| 6ET3 | 20ET1 | 20VT1 |
| 6ET7 | 20ET6 | 20VT6 |

High Performance RFI Filters for Switching Power Supplies *(continued)*

# T Series

## Electrical Schematics

### 3 & 6A



### 10A



### 15 & 20A



## Accessories

GA400: NEMA 5-15P to IEC 60320-1 C-13 line cord

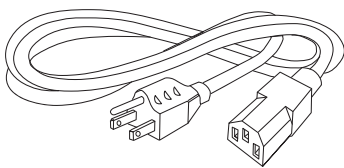

## Case Styles

### T1 (3, 6, 10A)



Typical Dimensions:

- Line/Load Terminals (4): .250 [6.3] with .07 [1.8] Dia. hole
- Ground Terminal (1): .250 [6.3] with .07 x .16 [1.8 x 3.8] slot
- Mounting Holes (2): .188 [4.78] Dia.

### T1 (15 & 20A)



Typical Dimensions:

- Line/Load Terminals (4): .250 [6.3] with .07 [1.8] Dia. hole
- Ground Terminal (1): .250 [6.3] with .07 x .16 [1.8 x 3.8] slot
- Mounting Slots (4): .250 x .156 [6.35 x 3.96] Dia.

### T3



Typical Dimensions:

- Wire Leads (5): 4.0 [101.6] Min., AWG18
- Mounting Holes (2): .188 [4.78] Dia.

**High Performance RFI Filters for Switching Power Supplies** *(continued)*

# T Series

## Case Styles *(continued)*

### T6



Typical Dimensions:  
 Terminals (5): 8-32, Torque 18 lbf-in. [2.03 N-m] max. ± 2 [.22]  
 Mounting Slots (4): .250 x .156 [6.35 x 3.96] Dia.

### T7



Typical Dimensions:  
 Load Terminals (2): .250 [6.3] with .07 [1.8] Dia. hole  
 Ground Terminal (1): .250 [6.3] with .07 x .16 [1.8 x 3.8] slot  
 Line Inlet (1): IEC 60320-1 C14  
 Tapped Inserts (2): 6-32 x 1/4

## Case Dimensions

| Part No.                      | A<br>(max)           | B<br>(max)          | C<br>(max)          | D<br>$\pm .015$<br>$\pm .38$ | E<br>(max)            |
|-------------------------------|----------------------|---------------------|---------------------|------------------------------|-----------------------|
| 3ET1, 6ET1                    | <b>3.56</b><br>90.4  | <b>2.15</b><br>54.6 | <b>1.81</b><br>46.0 | <b>2.938</b><br>74.63        | <b>3.38</b><br>85.9   |
| 3ET3, 6ET3                    | <b>2.55</b><br>64.8  | <b>2.15</b><br>54.6 | <b>1.81</b><br>46.0 | <b>2.938</b><br>74.63        | <b>3.38</b><br>85.9   |
| 3ET7, 6ET7                    | <b>3.52</b><br>89.4  | <b>2.25</b><br>57.2 | <b>1.78</b><br>45.2 | <b>1.575</b><br>40.01        | <b>0.63*</b><br>16.0* |
| 10ET1, 10VT1                  | <b>4.69</b><br>119.1 | <b>2.27</b><br>57.7 | <b>1.80</b><br>45.7 | <b>4.063</b><br>103.2        | <b>4.47</b><br>113.5  |
| 10ET3, 10VT3                  | <b>3.69</b><br>93.7  | <b>2.27</b><br>57.7 | <b>1.80</b><br>45.7 | <b>4.063</b><br>103.2        | <b>4.47</b><br>113.5  |
| 15ET1, 15VT1,<br>20ET1, 20VT1 | <b>5.45</b><br>138.4 | <b>3.12</b><br>79.2 | <b>2.18</b><br>55.4 | <b>3.5</b><br>88.9           | <b>3.96</b><br>100.6  |
| 15ET6, 15VT6,<br>20ET6, 20VT6 | <b>5.95</b><br>151.1 | <b>3.12</b><br>79.2 | <b>2.18</b><br>55.4 | <b>3.5</b><br>88.9           | <b>3.96</b><br>100.6  |

\*±0.02 [0.5]

## Recommended Panel Cutout

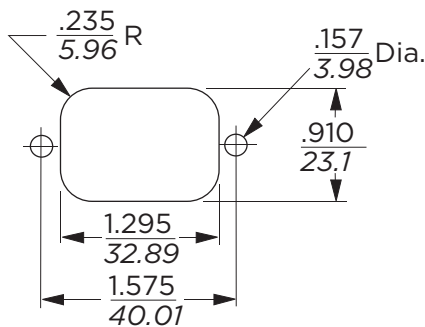

Tolerance ± .005 [0.13]

High Performance RFI Filters for Switching Power Supplies *(continued)*

# T Series

## Performance Data

### Typical Insertion Loss

Measured in closed 50 Ohm system

— Common Mode / Asymmetrical (L-G)  
— Differential Mode / Symmetrical (L-L)

**3ET**



**6ET**



**10ET**



**15ET**



**20ET**



**10VT**



**15VT**



**20VT**



### Minimum Insertion Loss

Measured in closed 50 Ohm system

Common Mode / Asymmetrical (Line to Ground)

Differential Mode / Symmetrical (Line to Line)

| Current Rating   | Frequency – MHz |     |     |     |    |    |    |    |    |    |    |
|------------------|-----------------|-----|-----|-----|----|----|----|----|----|----|----|
|                  | .01             | .03 | .05 | .15 | .5 | 1  | 2  | 5  | 10 | 20 | 30 |
| <b>ET Models</b> |                 |     |     |     |    |    |    |    |    |    |    |
| 3A               | 22              | 32  | 36  | 46  | 47 | 44 | 43 | 40 | 42 | 42 | 42 |
| 6A               | 16              | 26  | 30  | 41  | 47 | 44 | 43 | 43 | 40 | 42 | 42 |
| 10A              | 12              | 22  | 26  | 36  | 47 | 42 | 42 | 40 | 42 | 42 | 45 |
| 15A              | 8               | 17  | 22  | 31  | 43 | 44 | 44 | 42 | 47 | 52 | 43 |
| 20A              | 3               | 12  | 17  | 26  | 34 | 36 | 37 | 37 | 42 | 47 | 38 |

| Current Rating   | Frequency – MHz |     |     |     |    |    |    |    |    |    |    |
|------------------|-----------------|-----|-----|-----|----|----|----|----|----|----|----|
|                  | .01             | .03 | .05 | .15 | .5 | 1  | 2  | 5  | 10 | 20 | 30 |
| <b>ET Models</b> |                 |     |     |     |    |    |    |    |    |    |    |
| 3A               | 3               | 1   | 30  | 61  | 70 | 70 | 70 | 50 | 50 | 50 | 55 |
| 6A               | 4               | 2   | 14  | 51  | 70 | 70 | 70 | 65 | 47 | 50 | 55 |
| 10A              | 7               | 12  | 17  | 52  | 70 | 70 | 70 | 65 | 55 | 50 | 60 |
| 15A              | 12              | 19  | 15  | 51  | 70 | 70 | 70 | 70 | 70 | 65 | 60 |
| 20A              | 10              | 17  | 13  | 51  | 70 | 70 | 70 | 70 | 67 | 65 | 60 |

| Current Rating   | Frequency – MHz |     |     |     |    |    |    |    |    |    |    |
|------------------|-----------------|-----|-----|-----|----|----|----|----|----|----|----|
|                  | .01             | .03 | .05 | .15 | .5 | 1  | 2  | 5  | 10 | 20 | 30 |
| <b>VT Models</b> |                 |     |     |     |    |    |    |    |    |    |    |
| 10A              | 12              | 22  | 26  | 38  | 52 | 50 | 50 | 50 | 50 | 50 | 50 |
| 15A              | 8               | 17  | 22  | 33  | 52 | 52 | 52 | 52 | 57 | 45 | 35 |
| 20A              | 3               | 12  | 17  | 29  | 42 | 47 | 50 | 51 | 55 | 40 | 30 |

| Current Rating   | Frequency – MHz |     |     |     |    |    |    |    |    |    |    |
|------------------|-----------------|-----|-----|-----|----|----|----|----|----|----|----|
|                  | .01             | .03 | .05 | .15 | .5 | 1  | 2  | 5  | 10 | 20 | 30 |
| <b>VT Models</b> |                 |     |     |     |    |    |    |    |    |    |    |
| 10A              | 7               | 12  | 17  | 52  | 70 | 70 | 70 | 65 | 65 | 50 | 65 |
| 15A              | 12              | 19  | 15  | 51  | 70 | 70 | 70 | 70 | 70 | 65 | 60 |
| 20A              | 10              | 17  | 13  | 51  | 70 | 70 | 70 | 70 | 67 | 65 | 60 |

**RFI Filter for Power Factor Corrected Power Supplies**

# U Series



UL Recognized  
CSA Certified  
VDE Approved

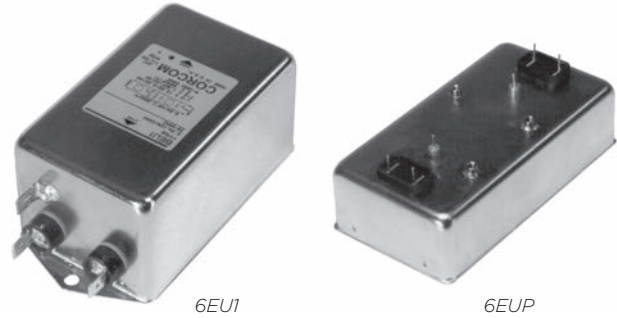

## U Series

- Designed for equipment using power factor corrected power supplies
- Offers high impedance circuit to mismatch the power supply's impedance characteristics
- Available in PC board mountable version
- All models meet low leakage current requirements

## Ordering Information



## Available Part Numbers

|      |      |
|------|------|
| 6EUP | 6EU1 |
|------|------|

## Specifications

- Maximum leakage current each Line to Ground:**  
 @ 120 VAC 60 Hz: .30 mA  
 @ 250 VAC 50 Hz: .50 mA
- Hipot rating (one minute):**  
 Line to Ground: 2250 VAC  
 Line to Line: 1450 VDC
- Rated Voltage (max):** 250 VAC
- Operating Frequency:** 50/60 Hz
- Rated Current:** 6A
- Operating Ambient Temperature Range (at rated current  $I_r$ ):** -10°C to +40°C  
 In an ambient temperature ( $T_a$ ) higher than +40°C the maximum operating current ( $I_o$ ) is calculated as follows:  $I_o = I_r \sqrt{(85-T_a)/45}$

## Electrical Schematic



**RFI Filter for Power Factor Corrected Power Supplies** *(continued)*

# U Series

## Case Styles

### 6EU1



Typical Dimensions:

- Line/Load Terminals (4): .250 [6.3] with .07 [1.8] Dia. hole
- Ground Terminal (1): .250 [6.3] with .07 x .16 [1.8 x 3.8] slot
- Mounting Holes (2): .188 [4.78] Dia.

### 6EUP



Typical Dimensions:

- Pins (6): 0.065 [1.65] diagonal max.
- Threaded insert(3): 6-32

## Recommended PC Board Layout



## Case Dimensions

| Part No. | A<br>(max)            | B<br>(max)           | C<br>(max)           | D<br>$\pm .015$<br>$\pm .38$ | E<br>(max)            |
|----------|-----------------------|----------------------|----------------------|------------------------------|-----------------------|
| 6EU1     | <b>4.95</b><br>125.73 | <b>2.27</b><br>57.66 | <b>1.80</b><br>45.72 | <b>4.060</b><br>103.12       | <b>4.47</b><br>113.54 |
| 6EUP     | <b>4.70</b><br>119.4  | <b>2.51</b><br>66.8  | <b>1.22</b><br>31.0  | -                            | -                     |

## Performance Data

### Typical Insertion Loss

Measured in closed 50 Ohm system



— Common Mode / Asymmetrical (L-G)  
— Differential Mode / Symmetrical (L-L)

## Minimum Insertion Loss

Common Mode / Asymmetrical (Line to Ground)

| Current Rating | Frequency – MHz |    |     |    |    |    |       |
|----------------|-----------------|----|-----|----|----|----|-------|
|                | .05             | .1 | .15 | .5 | 1  | 5  | 10 30 |
| 6A             | 4               | 30 | 40  | 70 | 70 | 70 | 65 50 |

Differential Mode / Symmetrical (Line to Line)

| Current Rating | Frequency – MHz |    |     |    |    |    |       |
|----------------|-----------------|----|-----|----|----|----|-------|
|                | .05             | .1 | .15 | .5 | 1  | 5  | 10 30 |
| 6A             | 10              | 35 | 45  | 70 | 70 | 70 | 65 55 |

Multipurpose Power Line RFI Filter for Emission Control

# V and W Series



UL Recognized  
CSA Certified  
VDE Approved<sup>1</sup>



Both the V and W series are effective to control emissions in equipment using SCR and T<sup>2</sup>L circuits for compliance with FCC Part 15, Subpart J and EN55022, Level A, down to 150kHz

## V Series

- Offers an N = 3 (“T”) Line to Ground impedance to common mode and an N = 5 “Dbl. Pi”) impedance for Line to Line differential mode interference
- Designed for susceptibility use when equipment impedance at RF frequencies is low

## W Series

- Offers an N = 4 (“Dbl. L”) Line to Ground impedance for common mode and an N=5 (“Dbl. Pi”) impedance for Line to Line differential mode interference
- Designed for use when equipment impedance at RF frequencies is high
- Two stage construction provides excellent suppression at high frequencies

## Ordering Information



\*IEC 60320-1 C20 inlet mates with C19 connector

## Specifications

- Maximum leakage current each Line to Ground:**  
 @ 120 VAC 60 Hz: .5 mA  
 @ 250 VAC 50 Hz: .82 mA
- Hipot rating (one minute):**  
 Line to Ground: 2250 VDC  
 Line to Line: 1450 VDC
- Rated Voltage (max):** 250 VAC
- Operating Frequency:** 50/60 Hz
- Rated Current:** 3 to 20A\*
- Operating Ambient Temperature Range (at rated current I<sub>r</sub>):** -10°C to +40°C  
 In an ambient temperature (T<sub>a</sub>) higher than +40°C the maximum operating current (I<sub>o</sub>) is calculated as follows:  $I_o = I_r \sqrt{(85-T_a)/45}$

## Electrical Schematics

### V Series



### W Series (3, 6 & 10A)



### W Series (20A)



<sup>1</sup>20VW7, 20A model tested by Underwriters Laboratories to US and Canadian requirements and is VDE approved at 16A, 250VAC



Multipurpose Power Line RFI Filter for Emission Control *(continued)*

# V and W Series

## Available Part Numbers

|       |        |
|-------|--------|
| 3VV1  | 3VW1   |
| 6VV1  | 3VW1   |
| 10VV1 | 10VW1  |
| 20VV1 | 20VW1  |
| 20VV6 | 20VW6  |
|       | 20VW7* |

## Case Styles

### V1 / W1 (3, 6 & 10A)



Typical Dimensions:  
 Line/Load Terminals (4): .250 [6.3] with .07 [1.8] Dia. hole  
 Ground Terminal (1): .250 [6.3] with .07 x .16 [1.8 x 3.8] slot  
 Mounting Holes (2): .188 [4.78] Dia.

### V1 / W1 (20A)

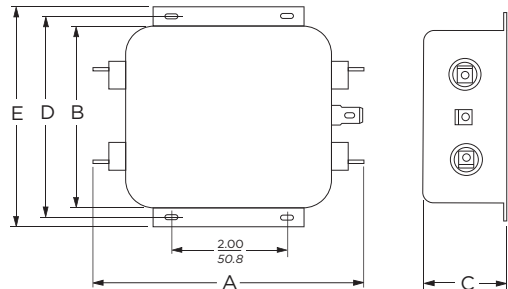

Typical Dimensions:  
 Line/Load Terminals (4): .250 [6.3] with .07 [1.8] Dia. hole  
 Ground Terminal (1): .250 [6.3] with .07 x .16 [1.8 x 3.8] slot  
 Mounting Slots (4): .250 x .156 [6.35 x 3.96] Dia.

### V6 / W6



Typical Dimensions:  
 Terminals (5): 8-32, Torque 18 lbf-in. [2.03 N-m] max. ± 2 [22]  
 Mounting Slots (4): .250 x .156 [6.35 x 3.96] Dia.

## Case Styles *(continued)*

### VW7



Typical Dimensions:  
 Load Terminals (2): .250 [6.3] with .07 [1.8] Dia. hole  
 Ground Terminal (1): .250 [6.3] with .07 x .16 [1.8 x 3.8] slot  
 Line Inlet (1): IEC 60320-1 C20  
 Tapped Inserts (2): 6-32 x 1/4

## Recommended Panel Cutout



## Case Dimensions

| Part No.     | A<br>(max)            | B<br>(max)           | C<br>(max)           | D<br>±.015<br>±.38    | E<br>(max)           |
|--------------|-----------------------|----------------------|----------------------|-----------------------|----------------------|
| 3VV1, 3VW1   | <b>3.36</b><br>85.3   | <b>1.82</b><br>46.2  | <b>1.28</b><br>32.5  | <b>2.375</b><br>60.33 | <b>2.78</b><br>70.6  |
| 6VV1, 6VW1   | <b>3.86</b><br>98.0   | <b>2.08</b><br>52.8  | <b>1.53</b><br>38.9  | <b>2.938</b><br>74.63 | <b>3.34</b><br>84.8  |
| 10VV1, 10VW1 | <b>3.86</b><br>98.0   | <b>2.08</b><br>52.8  | <b>1.53</b><br>38.9  | <b>2.938</b><br>74.63 | <b>3.34</b><br>84.8  |
| 20VV1, 20VW1 | <b>5.23</b><br>132.8  | <b>3.38</b><br>85.9  | <b>1.53</b><br>38.9  | <b>3.75</b><br>95.25  | <b>4.20</b><br>106.7 |
| 20VV6, 20VW6 | <b>5.34</b><br>135.64 | <b>3.38</b><br>85.9  | <b>1.53</b><br>38.9  | <b>3.76</b><br>95.5   | <b>4.20</b><br>106.7 |
| 20VW7        | <b>5.65</b><br>143.51 | <b>3.12</b><br>79.25 | <b>2.29</b><br>58.17 | —                     | —                    |

\*20VW7, 20A model tested by Underwriters Laboratories to US and Canadian requirements and is VDE approved at 16A, 250VAC

1  
RFI Power Line Filters

**Multipurpose Power Line RFI Filter for Emission Control** *(continued)*

# V and W Series

## Performance Data

### Typical Insertion Loss

Measured in closed 50 Ohm system

— Common Mode / Asymmetrical (L-G)  
— Differential Mode / Symmetrical (L-L)



### Minimum Insertion Loss

Measured in closed 50 Ohm system

Common Mode / Asymmetrical (Line to Ground)

| Current Rating  | Frequency – MHz |    |    |    |    |    |    |    |
|-----------------|-----------------|----|----|----|----|----|----|----|
|                 | .15             | .5 | 1  | 2  | 5  | 10 | 20 | 30 |
| <b>V Series</b> |                 |    |    |    |    |    |    |    |
| 3A              | 15              | 27 | 38 | 47 | 55 | 55 | 50 | 48 |
| 6A              | 15              | 27 | 28 | 47 | 55 | 55 | 50 | 48 |
| 10A             | 15              | 27 | 38 | 47 | 55 | 55 | 50 | 48 |
| 20A             | 15              | 30 | 41 | 49 | 55 | 46 | 36 | 30 |
| <b>W Series</b> |                 |    |    |    |    |    |    |    |
| 3A              | 13              | 25 | 20 | 45 | 60 | 65 | 65 | 63 |
| 6A              | 18              | 30 | 34 | 40 | 65 | 65 | 57 | 47 |
| 10A             | 18              | 30 | 34 | 40 | 65 | 65 | 57 | 47 |
| 20A             | 18              | 30 | 34 | 40 | 65 | 65 | 57 | 47 |

Differential Mode / Symmetrical (Line to Line)

| Current Rating  | Frequency – MHz |    |    |    |    |    |    |    |
|-----------------|-----------------|----|----|----|----|----|----|----|
|                 | .15             | .5 | 1  | 2  | 5  | 10 | 20 | 30 |
| <b>V Series</b> |                 |    |    |    |    |    |    |    |
| 3A              | 25              | 25 | 65 | 63 | 60 | 52 | 50 | 50 |
| 6A              | 40              | 54 | 65 | 65 | 65 | 60 | 57 | 55 |
| 10A             | 25              | 25 | 65 | 63 | 60 | 52 | 50 | 50 |
| 20A             | 25              | 25 | 65 | 63 | 60 | 52 | 50 | 50 |
| <b>W Series</b> |                 |    |    |    |    |    |    |    |
| 3A              | 25              | 40 | 65 | 65 | 62 | 55 | 35 | 35 |
| 6A              | 30              | 54 | 65 | 65 | 60 | 55 | 38 | 38 |
| 10A             | 25              | 25 | 65 | 65 | 65 | 50 | 45 | 45 |
| 20A             | 25              | 25 | 65 | 65 | 65 | 50 | 45 | 45 |

**High Performance, Low Cost Filter Ideal for Appliance Equipment**

# WG Series



UL Recognized  
CSA Certified  
VDE Approved



WG\_1 Style

## WG Series

- Cost-effective
- Tubular design
- WGA, WGB and WGC versions designed to comply with leakage current for fixed appliances not easily moved from one place to another
- WGD, WGE and WGF versions designed to comply with leakage current requirements for appliances which may be easily moved from one place to another
- Available in a variety of styles

## Ordering Information



## Specifications

### Maximum leakage current each Line to Ground:

|                  | A, B & C Models | D, E & F Models |
|------------------|-----------------|-----------------|
| @ 120 VAC 60 Hz: | .76 mA          | .10 mA          |
| @ 250 VAC 50 Hz: | 1.27 mA         | .20 mA          |

### Hipot rating (one minute):

|                 |          |
|-----------------|----------|
| Line to Ground: | 2250 VDC |
| Line to Line:   | 1450 VDC |

### Rated Voltage (max):

250 VAC

### Operating Frequency:

50/60 Hz

### Rated Current:

16A

### Operating Ambient Temperature Range

(at rated current  $I_r$ ): -10°C to +40°C

In an ambient temperature ( $T_a$ ) higher than +40°C the maximum operating current ( $I_o$ ) is calculated as follows:  $I_o = I_r \sqrt{(85-T_a)/45}$

## Electrical Schematics



### With RAST 5 Connector (style 7)



## Available Part Numbers

|        |        |        |
|--------|--------|--------|
| 16WGA1 | 16WGA3 | 16WGA7 |
| 16WGB1 | 16WGB3 | 16WGB7 |
| 16WGC1 | 16WGC3 | 16WGC7 |
| 16WGD1 | 16WGD3 | 16WGD7 |
| 16WGE1 | 16WGE3 | 16WGE7 |
| 16WGF1 | 16WGF3 | 16WGF7 |

**High Performance, Low Cost Filter for Appliance Equipment** *(continued)*

# WG Series

## Case Styles

### WG\_1



Typical Dimensions:  
Terminals (5): .25 [6.3] with .07 [1.8] Dia. hole  
Mounting Stud (1): M8 x 1.25

### WG\_7



Typical Dimensions:  
Terminals (3): .25 [6.3] with .07 [1.8] Dia. hole  
RAST 5: Unkeyed RAST 5 Header interface\*  
Mounting Stud (1): M8 x 1.25

\*The RAST 5 interface mates with any two-position (keyed or unkeyed) TE Standard Power Timer connector or RAST 5 Positive Lock Mark III connector

### WG\_3



Typical Dimensions:  
Wire Leads(5): 4.0 [101.6] min. 18AWG UL 1015  
Mounting Stud (1): M8 x 1.25

#### Wire Colors:

|      |                |
|------|----------------|
| L(2) | Brown          |
| N(4) | Blue           |
| U(1) | Brown          |
| Gnd  | Green / Yellow |
| U(3) | Blue           |



WG\_7 Style

**High Performance, Low Cost Filter for Appliance Equipment** *(continued)*

# WG Series

## Performance Data

### Typical Insertion Loss

Measured in closed 50 Ohm system

### All Case Styles

**16WGA**



**16WGB**



**16WGC**



**16WGD**



**16WGE**



**16WGF**



— Common Mode / Asymmetrical (L-G)  
— Differential Mode / Symmetrical (L-L)

### Minimum Insertion Loss

Measured in closed 50 Ohm system

#### Common Mode / Asymmetrical (Line to Ground)

| Part No.          | Frequency – MHz |    |     |    |    |    |    |    |    |    |
|-------------------|-----------------|----|-----|----|----|----|----|----|----|----|
|                   | .05             | .1 | .15 | .5 | 1  | 2  | 5  | 10 | 20 | 30 |
| <b>All Styles</b> |                 |    |     |    |    |    |    |    |    |    |
| 16WGA             | 3               | 10 | 14  | 33 | 41 | 47 | 54 | 50 | 37 | 30 |
| 16WGB             | 11              | 16 | 21  | 33 | 39 | 44 | 53 | 55 | 37 | 30 |
| 16WGC             | 12              | 18 | 22  | 34 | 41 | 46 | 51 | 52 | 34 | 27 |
| 16WGD             | 3               | 8  | 11  | 22 | 26 | 31 | 31 | 33 | 40 | 44 |
| 16WGE             | 5               | 12 | 15  | 21 | 23 | 25 | 31 | 32 | 37 | 45 |
| 16WGF             | 9               | 14 | 18  | 24 | 26 | 28 | 31 | 32 | 37 | 44 |

#### Differential Mode / Symmetrical (Line to Line)

| Part No.          | Frequency – MHz |    |     |    |    |    |    |    |    |    |
|-------------------|-----------------|----|-----|----|----|----|----|----|----|----|
|                   | .05             | .1 | .15 | .5 | 1  | 2  | 5  | 10 | 20 | 30 |
| <b>All Styles</b> |                 |    |     |    |    |    |    |    |    |    |
| 16WGA             | 14              | 19 | 22  | 33 | 41 | 51 | 47 | 42 | 48 | 50 |
| 16WGB             | 14              | 19 | 22  | 33 | 41 | 51 | 50 | 45 | 52 | 45 |
| 16WGC             | 13              | 19 | 22  | 33 | 40 | 50 | 58 | 42 | 48 | 42 |
| 16WGD             | 13              | 19 | 22  | 33 | 40 | 48 | 58 | 57 | 54 | 45 |
| 16WGE             | 13              | 19 | 22  | 33 | 40 | 48 | 58 | 57 | 51 | 45 |
| 16WGF             | 13              | 19 | 22  | 33 | 40 | 49 | 58 | 59 | 50 | 44 |

**Chassis or PC Board Mountable Power Line Filters for Emission Control**

# X, Y, Z Series



UL Recognized  
CSA Certified  
VDE Approved



XP / YP / ZP



3EX1 / 3EZ1

## X, Y, Z Series

- Compact chassis or PC board mountable
- Three levels of performance
- Complete filtering solution in minimal size

### X Series

- Designed to bring most digital equipment (including those with switching power supplies) into compliance with FCC Part 15J, Class B conducted emission limits

### Y Series

- Designed to bring most digital equipment (including those with switching power supplies) into compliance with EN55022, Level A and FCC Part 15J, Class B conducted emission limits

### Z Series

- Designed to bring most digital equipment (including those with switching power supplies) into compliance with EN55022, Level B and FCC Part 15J, Class B conducted emission limits

## Ordering Information



## Specifications

### Maximum leakage current each Line to Ground:

|                  |        |
|------------------|--------|
| @ 120 VAC 60 Hz: | .30 mA |
| @ 250 VAC 50 Hz: | .50 mA |

### Hipot rating (one minute):

|                 |          |
|-----------------|----------|
| Line to Ground: | 2250 VDC |
| Line to Line:   | 1450 VDC |

### Rated Voltage (max):

250 VAC

### Operating Frequency:

50/60 Hz

### Rated Current:

1 to 6A

### Operating Ambient Temperature Range

(at rated current  $I_r$ ): -10°C to +40°C

In an ambient temperature ( $T_a$ ) higher than +40°C the maximum operating current ( $I_o$ ) is calculated as follows:  $I_o = I_r \sqrt{(85-T_a)/45}$

## Electrical Schematic

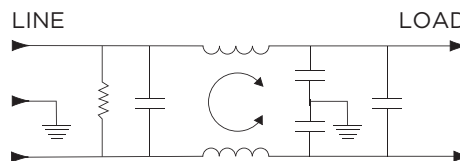

## Available Part Numbers

|      |      |
|------|------|
| 3EXP | 4EYP |
| 3EX1 | 1EZP |
| 4EXP | 2EZP |
| 6EXP | 3EZP |
| 2EYP | 3EZ1 |
| 3EYP |      |

**Chassis & PC Board Mountable RFI Filters for Emission Control** *(continued)*

# X, Y, Z Series

## Case Styles

### X1 & Z1



Typical Dimensions:

- Line/Load Terminals (4): .250 [6.3] with .07 [1.8] Dia. hole
- Ground Terminal (1): .250 [6.3] with .07 x .16 [1.8 x 3.8] slot
- Mounting Holes (2): .188 [4.78] Dia.

### XP, YP & ZP

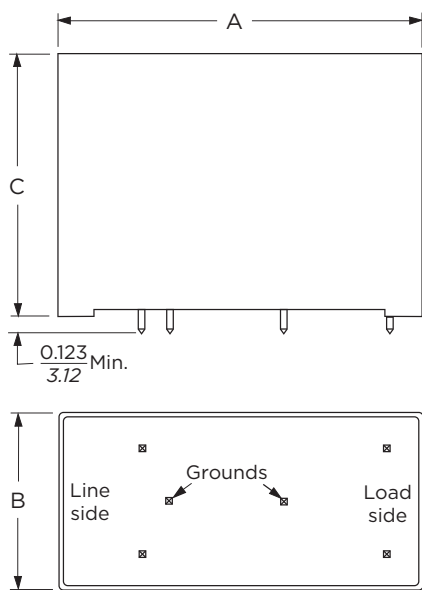

Typical Dimensions:

- Pins (5): 0.065 [1.65] max. diagonal

## Case Dimensions

| Part No.   | A<br>(max)          | B<br>(max)          | C<br>(max)           | D<br>$\pm .015$<br>$\pm .38$ | E<br>(max)           |
|------------|---------------------|---------------------|----------------------|------------------------------|----------------------|
| 3EXP       | <b>2.61</b><br>66.3 | <b>1.13</b><br>28.7 | <b>1.62</b><br>41.1  | —                            | —                    |
| 3EX1       | <b>3.01</b><br>76.7 | <b>1.84</b><br>46.8 | <b>1.16</b><br>29.46 | <b>2.375</b><br>60.33        | <b>2.79</b><br>70.87 |
| 4EXP       | <b>2.61</b><br>66.6 | <b>1.13</b><br>28.7 | <b>1.62</b><br>41.1  | —                            | —                    |
| 6EXP       | <b>2.61</b><br>66.3 | <b>1.13</b><br>28.7 | <b>1.75</b><br>44.5  | —                            | —                    |
| 2EYP       | <b>2.61</b><br>66.3 | <b>1.13</b><br>28.7 | <b>1.62</b><br>41.1  | —                            | —                    |
| 3EYP, 4EYP | <b>2.61</b><br>66.3 | <b>1.13</b><br>28.7 | <b>1.75</b><br>44.5  | —                            | —                    |
| 1EZP       | <b>2.61</b><br>66.3 | <b>1.13</b><br>28.7 | <b>1.62</b><br>41.1  | —                            | —                    |
| 2EZP, 3EZP | <b>2.61</b><br>66.3 | <b>1.13</b><br>28.7 | <b>1.75</b><br>44.5  | —                            | —                    |
| 3EZ1       | <b>3.54</b><br>89.9 | <b>2.08</b><br>52.8 | <b>1.31</b><br>33.3  | <b>2.938</b><br>74.63        | <b>3.35</b><br>85.1  |

## Recommended PC Board Layout



**Chassis & PC Board Mountable RFI Filters for Emission Control** *(continued)*

# X, Y, Z Series

## Performance Data

### Typical Insertion Loss

Measured in closed 50 Ohm system

**3EX**



**4EX**



**6EX**



**2EY**



**3EY**



**4EY**

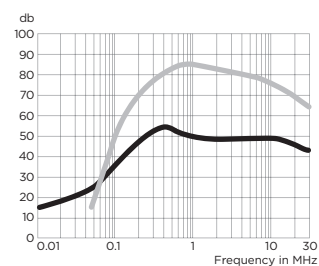

**1EZ**



**2EZ**



**3EZ**



— Common Mode / Asymmetrical (L-G)  
— Differential Mode / Symmetrical (L-L)



**Chassis & PC Board Mountable RFI Filters for Emission Control** *(continued)*

**Performance Data** *(Continued)*

**Minimum Insertion Loss**

Measured in closed 50 Ohm system

Common Mode / Asymmetrical (Line to Ground)

| Part No.        | Frequency – MHz |     |     |    |    |    |    |    |
|-----------------|-----------------|-----|-----|----|----|----|----|----|
|                 | .01             | .05 | .15 | .5 | 1  | 5  | 10 | 30 |
| <b>X Series</b> |                 |     |     |    |    |    |    |    |
| 3A              | 2               | 13  | 21  | 35 | 46 | 44 | 44 | 44 |
| 4A              | 2               | 13  | 22  | 38 | 44 | 44 | 44 | 38 |
| 6A              | 2               | 11  | 20  | 35 | 40 | 40 | 40 | 36 |
| <b>Y Series</b> |                 |     |     |    |    |    |    |    |
| 2A              | 8               | 21  | 31  | 49 | 44 | 40 | 40 | 40 |
| 3A              | 11              | 24  | 36  | 43 | 40 | 40 | 40 | 40 |
| 4A              | 5               | 18  | 28  | 45 | 40 | 40 | 40 | 36 |
| <b>Z Series</b> |                 |     |     |    |    |    |    |    |
| 1A              | 18              | 32  | 43  | 47 | 44 | 43 | 43 | 45 |
| 2A              | 18              | 32  | 45  | 41 | 40 | 40 | 40 | 40 |
| 3A              | 15              | 29  | 39  | 43 | 42 | 40 | 40 | 40 |

Differential Mode / Symmetrical (Line to Line)

| Part No.        | Frequency – MHz |     |     |     |     |    |    |    |    |    |
|-----------------|-----------------|-----|-----|-----|-----|----|----|----|----|----|
|                 | .02             | .03 | .05 | .07 | .15 | .5 | 1  | 5  | 10 | 30 |
| <b>X Series</b> |                 |     |     |     |     |    |    |    |    |    |
| 3A              | -               | -   | -   | 5   | 34  | 60 | 65 | 60 | 45 | 50 |
| 4A              | -               | -   | -   | 10  | 37  | 70 | 70 | 70 | 65 | 55 |
| 6A              | -               | -   | -   | 3   | 31  | 65 | 70 | 70 | 65 | 55 |
| <b>Y Series</b> |                 |     |     |     |     |    |    |    |    |    |
| 2A              | -               | -   | 10  | 19  | 40  | 70 | 75 | 70 | 60 | 55 |
| 3A              | -               | -   | 10  | 20  | 42  | 68 | 68 | 67 | 62 | 50 |
| 4A              | -               | -   | 6   | 18  | 41  | 67 | 75 | 70 | 65 | 55 |
| <b>Z Series</b> |                 |     |     |     |     |    |    |    |    |    |
| 1A              | 7               | 29  | 34  | 43  | 62  | 70 | 70 | 70 | 60 | 55 |
| 2A              | 2               | 15  | 31  | 40  | 57  | 75 | 70 | 65 | 55 | 50 |
| 3A              | -               | 10  | 26  | 34  | 53  | 75 | 75 | 70 | 60 | 55 |



---

**Engineering Notes**

---



## 2. Three Phase Filters – Table of Contents

|                                  |     |
|----------------------------------|-----|
| Three Phase Selector Chart ..... | 97  |
| A Series .....                   | 98  |
| ADT Series .....                 | 101 |
| AYA Series .....                 | 104 |
| AYC Series .....                 | 108 |
| AYO Series .....                 | 111 |
| BCF Series .....                 | 113 |
| CFN Series .....                 | 116 |
| FCD Series .....                 | 118 |

### Three Phase Selector Chart



**High Performance 3-phase RFI Filters for WYE Applications**

# A Series



UL Recognized  
CSA Certified  
VDE Approved



## A Series

- For 3-phase, four wire, WYE Applications
- Filters each of the three lines plus the neutral and ground line
- Both common mode and differential mode suppression from 50kHz to 30MHz
- Effective for both balanced and unbalanced loads
- Ground choke included
- Optional end bell kits available to shield input and output terminals
- AYP single stage for lower noise environments
- AYT dual stage provides highest performance

## Ordering Information



## Specifications

**Maximum leakage current, each Line to Ground:**

|                  |        |
|------------------|--------|
| @ 120 VAC 60 Hz: | 1.4 mA |
| @ 250 VAC 50 Hz: | 3.4 mA |

**Hipot rating (one minute):**

|                    |          |
|--------------------|----------|
| Line to Ground:    | 1500 VAC |
| Neutral to Ground: | 1500 VAC |
| Line to Neutral:   | 1450 VDC |

**Rated Voltage (max):**

|                            |         |
|----------------------------|---------|
| Phase to Phase:            | 440 VAC |
| Phase to Neutral / Ground: | 250 VAC |

**Operating Frequency:**

50/60 Hz

**Rated Current:**

20 to 60A

**Operating Ambient Temperature Range**

(at rated current  $I_r$ ): -10°C to +40°C  
In an ambient temperature ( $T_a$ ) higher than +40°C the maximum operating current ( $I_o$ ) is calculated as follows:  $I_o = I_r \sqrt{(85-T_a)/45}$

## Electrical Schematics

### AYP6C Models



**High Performance 3-phase RFI Filters for WYE Applications** *(continued)*

# A Series

## Electrical Schematics *(continued)*

### AYT6C Models



### Available Part Numbers

|         |         |
|---------|---------|
| 20AYP6C | 20AYT6C |
| 30AYP6C | 30AYT6C |
| 45AYP6C | 45AYT6C |
| 60AYP6C | 60AYT6C |

### Accessories

Mounting bracket kit with captive nuts:

**AA400:** 20A & 30A versions

**AA405:** 45A & 60A versions



Protective cover for use with mounting bracket:

*(For Europe only. Limited availability in other regions)*

**AA406A:** 20A & 30A versions

**AA407A:** 45A & 60A versions

End bell kit (bracket and cover) with captive nuts:

**AA406:** 20A & 30A versions

**AA407:** 45A & 60A versions



AA406 / AA407  
Kits includes both  
bracket and cover

Additional captive nuts:

**AA401:** 10 nuts

## Case Style



Terminals:  
1/4 x 20 (10)

Mounting studs:  
No. 8-32 (8)

Torque: 56 lbf-in ±2  
6.33 N-m ±23

## Case Dimensions

| Part No. | A*<br>(max.)   | B<br>(max.)   | C<br>(max.)   | D<br>±.030<br>±.76 | E<br>±.015<br>±.38 |
|----------|----------------|---------------|---------------|--------------------|--------------------|
| 20AYP6C  | 8.82<br>224.0  | 5.57<br>141.5 | 2.56<br>65.0  | 4.616<br>117.2     | 1.50<br>38.1       |
| 30AYP6C  | 8.82<br>224.0  | 5.57<br>141.5 | 2.56<br>65.0  | 4.616<br>117.2     | 1.50<br>38.1       |
| 45AYP6C  | 9.43<br>239.5  | 6.92<br>175.8 | 4.82<br>122.4 | 5.95<br>151.1      | 3.75<br>95.3       |
| 60AYP6C  | 9.43<br>239.5  | 6.92<br>175.8 | 4.82<br>122.4 | 5.95<br>151.1      | 3.75<br>95.3       |
| 20AYT6C  | 13.82<br>351.0 | 5.57<br>141.5 | 2.56<br>65.0  | 4.616<br>117.2     | 1.50<br>38.1       |
| 30AYT6C  | 13.82<br>351.0 | 5.57<br>141.5 | 2.56<br>65.0  | 4.616<br>117.2     | 1.50<br>38.1       |
| 45AYT6C  | 13.83<br>351.3 | 6.92<br>175.8 | 4.82<br>122.4 | 5.95<br>151.1      | 3.75<br>95.3       |
| 60AYT6C  | 13.83<br>351.3 | 6.92<br>175.8 | 4.82<br>122.4 | 5.95<br>151.1      | 3.75<br>95.3       |

\*For end bell covering terminals and connections, add:  
20 & 30A: 5.57 [ 141.48 ]  
45 & 60A: 6.45 [ 163.83 ]

**High Performance 3-phase RFI Filters for WYE Applications** *(continued)*

# A Series

## Performance Data

### Typical Insertion Loss

Measured in closed 50 Ohm system

**20AYP6C**



**30AYP6C**



**45AYP6C**



**60AYP6C**



**20AYT6C**



**30AYT6C**



**45AYT6C**



**60AYT6C**



— Common Mode / Asymmetrical (L-G)  
— Differential Mode / Symmetrical (L-L)

### Minimum Insertion Loss

Measured in closed 50 Ohm system

#### AYP6C

Common Mode / Asymmetrical (Line to Ground)

| Current Rating | Frequency –MHz |    |     |    |    |    |    |    |
|----------------|----------------|----|-----|----|----|----|----|----|
|                | .05            | .1 | .15 | .5 | 1  | 5  | 10 | 30 |
| 20A            | 22             | 32 | 39  | 55 | 56 | 65 | 65 | 54 |
| 30A            | 15             | 24 | 30  | 55 | 55 | 61 | 63 | 50 |
| 45A            | 8              | 19 | 25  | 49 | 49 | 56 | 58 | 45 |
| 60A            | 5              | 16 | 22  | 50 | 50 | 54 | 54 | 47 |

Differential Mode / Symmetrical (Line to Line)

| Current Rating | Frequency –MHz |    |     |    |    |    |    |    |
|----------------|----------------|----|-----|----|----|----|----|----|
|                | .05            | .1 | .15 | .5 | 1  | 5  | 10 | 30 |
| 20A            | 20             | 38 | 50  | 65 | 65 | 65 | 60 | 52 |
| 30A            | 18             | 28 | 43  | 65 | 65 | 65 | 59 | 48 |
| 45A            | 8              | 20 | 27  | 60 | 65 | 65 | 56 | 43 |
| 60A            | 20             | 24 | 27  | 60 | 65 | 65 | 56 | 50 |

#### AYT6C

Common Mode / Asymmetrical (Line to Ground)

| Current Rating | Frequency –MHz |    |     |    |    |    |    |    |
|----------------|----------------|----|-----|----|----|----|----|----|
|                | .05            | .1 | .15 | .5 | 1  | 5  | 10 | 30 |
| 20A            | 45             | 63 | 70  | 75 | 75 | 75 | 75 | 65 |
| 30A            | 29             | 53 | 61  | 75 | 75 | 75 | 75 | 60 |
| 45A            | 15             | 36 | 43  | 75 | 75 | 75 | 75 | 50 |
| 60A            | 12             | 37 | 46  | 75 | 75 | 75 | 70 | 45 |

Differential Mode / Symmetrical (Line to Line)

| Current Rating | Frequency –MHz |    |     |    |    |    |    |    |
|----------------|----------------|----|-----|----|----|----|----|----|
|                | .05            | .1 | .15 | .5 | 1  | 5  | 10 | 30 |
| 20A            | 27             | 56 | 65  | 70 | 70 | 70 | 70 | 70 |
| 30A            | 17             | 46 | 55  | 75 | 75 | 75 | 75 | 70 |
| 45A            | 14             | 41 | 50  | 75 | 75 | 75 | 75 | 65 |
| 60A            | 26             | 50 | 58  | 75 | 75 | 75 | 75 | 60 |

High Performance High Current 3-phase Delta RFI Filters

# ADT Series



UL Recognized



## ADT Series

- Designed for very high insertion loss for Delta three phase, three wire applications
- Available with common or differential mode coils

## Ordering Information



## Available Part Numbers

|         |          |
|---------|----------|
| 63ADT6  | 63ADT6S  |
| 100ADT6 | 100ADT6S |
| 160ADT6 | 160ADT6S |
| 200ADT6 | 200ADT6S |

## Specifications

**Maximum leakage current at 277 VAC 60 Hz, each Line to Ground:**

|                    |       |
|--------------------|-------|
| ADT6:              | 1.3 A |
| 63ADT6S:           | 2.6 A |
| 100, 160, 200ADT6S | 4.6 A |

**Hipot rating (one minute):**

|                 |          |
|-----------------|----------|
| Line to Ground: | 2210 VDC |
| Line to Line:   | 2158 VDC |

**Rated Voltage (max):**

|                  |         |
|------------------|---------|
| Phase to Phase:  | 480 VAC |
| Phase to Ground: | 277 VAC |

**Operating Frequency:**

50/60 Hz

**Rated Current:**

63 to 200A

**Operating Ambient Temperature Range**

(at rated current  $I_r$ ): -10°C to +40°C

In an ambient temperature ( $T_a$ ) higher than +40°C the maximum operating current ( $I_o$ ) is calculated as follows:  $I_o = I_r \sqrt{(85-T_a)/45}$

## Electrical Schematics

### 63ADT6



High Performance High Current 3-phase Delta RFI Filters (continued)

# ADT Series

## Electrical Schematics (continued)

### 100, 160 & 200 ADT6



### ADT6S



## Case Style



Terminals (6) :  
 63ADT6, 63ADT6S, 100ADT6S: 3/8-16, Torque (max.) 70 lbf-in [7.91 N-m]  
 100ADT6, 160 & 200 ADT6/S: 7/16-20, Torque (max.) 125 lbf-in [14.12 N-m]

## Case Dimensions

| Part No.     | A<br>(max.)    | B<br>(max.)    | C<br>(max.)  | D<br>$\pm .030$<br>$\pm .76$ | E<br>(max.)    | F<br>$\pm .030$<br>$\pm .76$ | G<br>$\pm .030$<br>$\pm .76$ | H<br>$\pm .030$<br>$\pm .76$ | J<br>$\pm .030$<br>$\pm .76$ | K<br>(max.)   |
|--------------|----------------|----------------|--------------|------------------------------|----------------|------------------------------|------------------------------|------------------------------|------------------------------|---------------|
| 63ADT6       | 14.00<br>355.6 | 10.00<br>254.0 | 3.5<br>89.0  | 8.5<br>216.0                 | 10.00<br>254.0 | 11.97<br>304.0               | 7.5<br>190.35                | 1.75<br>44.4                 | 2.00<br>50.8                 | 6.00<br>152.4 |
| 63ADT6S      | 19.00<br>482.6 | 10.00<br>254.0 | 4.5<br>114.3 | 8.5<br>216.0                 | 15.00<br>381.0 | 16.97<br>431.0               | 7.5<br>190.5                 | 3.00<br>76.2                 | 3.00<br>76.2                 | 6.00<br>152.4 |
| 100ADT6      | 19.00<br>482.6 | 10.00<br>254.0 | 4.5<br>114.3 | 8.5<br>216.0                 | 15.00<br>381.0 | 16.97<br>431.0               | 7.5<br>190.5                 | 3.00<br>76.2                 | 3.00<br>76.2                 | 6.00<br>152.4 |
| 100ADT6S     | 19.00<br>482.6 | 11.00<br>279.4 | 4.5<br>114.3 | 8.5<br>216.0                 | 15.00<br>381.0 | 16.97<br>431.0               | 8.5<br>215.9                 | 3.00<br>76.2                 | 3.00<br>76.2                 | 6.00<br>152.4 |
| 160/200ADT6  | 19.00<br>482.6 | 10.00<br>254.0 | 4.5<br>114.3 | 8.5<br>216.0                 | 15.00<br>381.0 | 16.97<br>431.0               | 7.5<br>190.5                 | 3.00<br>76.2                 | 3.00<br>76.2                 | 6.00<br>152.4 |
| 160/200ADT6S | 22.00<br>558.8 | 13.00<br>330.2 | 4.5<br>114.3 | 11.5<br>292.2                | 18.00<br>457.2 | 19.97<br>507.2               | 10.5<br>266.7                | 2.75<br>69.8                 | 3.00<br>76.2                 | 7.00<br>177.8 |



**High Performance High Current 3-phase Delta RFI Filters** *(continued)*

# ADT Series

## Performance Data

### Typical Insertion Loss

Measured in closed 50 Ohm system

**63ADT6**

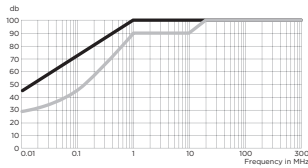

**100ADT6**

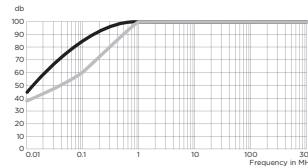

**160ADT6**

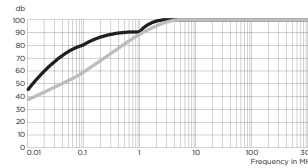

**200ADT6**

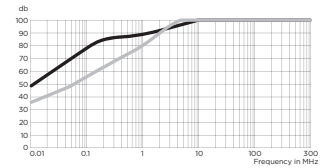

**63ADT6S**

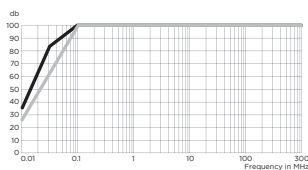

**100ADT6S**

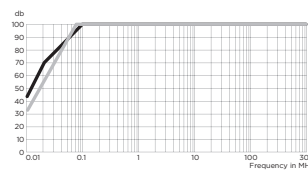

**160ADT6S**

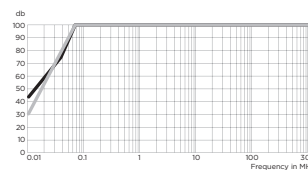

**200ADT6S**

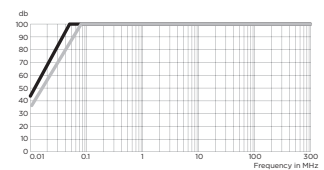

— Common Mode / Asymmetrical (L-G)  
- - - Differential Mode / Symmetrical (L-L)

### Minimum Insertion Loss

Measured in closed 50 Ohm system

Common Mode / Asymmetrical (Line to Ground)

| Part No. | Frequency –MHz |    |    |     |     |     |     |
|----------|----------------|----|----|-----|-----|-----|-----|
|          | .01            | .1 | 1  | 10  | 30  | 100 | 300 |
| 63ADT6   | 45             | 85 | 95 | 100 | 100 | 100 | 100 |
| 100ADT6  | 45             | 85 | 90 | 100 | 100 | 100 | 100 |
| 160ADT6  | 45             | 80 | 90 | 100 | 100 | 100 | 100 |
| 200ADT6  | 45             | 77 | 88 | 100 | 100 | 100 | 100 |
| 63ADT6S  | 28             | 45 | 90 | 90  | 90  | 90  | 90  |
| 100ADT6S | 38             | 60 | 95 | 100 | 100 | 100 | 100 |
| 160ADT6S | 37             | 58 | 85 | 100 | 100 | 100 | 100 |
| 200ADT6S | 35             | 54 | 80 | 100 | 100 | 100 | 100 |

Differential Mode / Symmetrical (Line to Line)

| Part No. | Frequency –MHz |     |     |     |     |     |     |
|----------|----------------|-----|-----|-----|-----|-----|-----|
|          | .01            | .1  | 1   | 10  | 30  | 100 | 300 |
| 63ADT6   | 35             | 100 | 100 | 100 | 100 | 100 | 100 |
| 100ADT6  | 43             | 100 | 100 | 100 | 100 | 100 | 100 |
| 160ADT6  | 44             | 100 | 100 | 100 | 100 | 100 | 100 |
| 200ADT6  | 43             | 100 | 100 | 100 | 100 | 100 | 100 |
| 63ADT6S  | 35             | 100 | 100 | 100 | 100 | 100 | 100 |
| 100ADT6S | 43             | 100 | 100 | 100 | 100 | 100 | 100 |
| 160ADT6S | 44             | 100 | 100 | 100 | 100 | 100 | 100 |
| 200ADT6S | 43             | 100 | 100 | 100 | 100 | 100 | 100 |

3-phase WYE RFI Power Line Filters

# AYA Series



UL Recognized\*



25AYA6A

## AYA Series

- For 3-phase, four wire, WYE applications
- Cost-effective, universal 3-phase filters
- Good attenuation over the complete frequency range of 10kHz to 30MHz
- Two different mounting styles available

## Specifications

**Maximum leakage current each Line to Ground:**  
 @ 120 VAC 60 Hz: 1.62 mA  
 @ 250 VAC 50 Hz: 2.82 mA

**Hipot rating (one minute):**  
 Line to Ground: 1500 VAC  
 Line to Line: 1450 VDC

**Rated Voltage (max):**  
 Phase to Phase: 440 VAC  
 Phase to Ground: 250 VAC

**Operating Frequency:** 50/60 Hz

**Rated Current:** 16 to 100A\*

**Operating Ambient Temperature Range (at rated current I<sub>r</sub>):** -10°C to +40°C  
 In an ambient temperature (T<sub>a</sub>) higher than +40°C the maximum operating current (I<sub>O</sub>) is calculated as follows:  $I_O = I_r \sqrt{(85-T_a)/45}$

## Ordering Information



## Available Part Numbers

| Flange Mount | Bulkhead Mount |
|--------------|----------------|
| 16AYA6A      | 16AYA6         |
| 16AYA10      | 25AYA6         |
| 25AYA6A      | 36AYA6         |
| 36AYA6A      | 50AYA6         |
| 36AYA10      |                |
| 50AYA6A      |                |
| 63AYA6A      |                |
| 63AYA10      |                |
| 100AYA6A     |                |

\*UL Approvals for all models except: 16AYA10, 36AYA10, 63AYA10, 63AYA6, 63AYA6A and 100AYA6A

3-phase WYE RFI Power Line Filters (continued)

# AYA Series

## Electrical Schematic

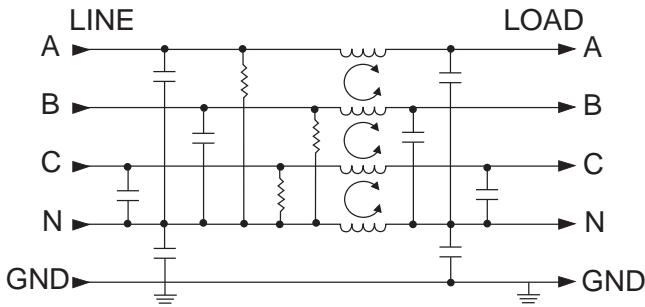

## Case Style

**AYA6A** (Flange mount with screw terminals)



Typical Dimensions:  
 Mounting slots (4): .425 x .254 [10.8 x 6.6]  
 16 & 25A Terminals(8): 8-32, Torque (max.) 26 lbf-in [2.94 N-m]  
 36A Terminals(8): 10-32, Torque (max.) 27 lbf-in [3.05 N-m]  
 50, 63 & 100A Terminals(8): 1/4-20, Torque (max.) 56 lbf-in [6.33 N-m]

**AYA6** (Bulkhead mount with screw terminals)



Typical Dimensions:  
 Threaded mounting holes(4): M5 x 8  
 16 & 25A Terminals(8): 8-32, Torque (max.) 26 lbf-in [2.94 N-m]  
 36A Terminals(8): 10-32, Torque (max.) 27 lbf-in [3.05 N-m]  
 50A Terminals(8): 1/4-20, Torque (max.) 56 lbf-in [6.33 N-m]

**16AYA10**



Typical Dimensions:  
 Mounting slots (4): .425 x .254 [10.8 x 6.6]  
 Terminal blocks(8): 4 mm<sup>2</sup> Torque (max.) 7.08 lbf-in [0.8 N-m]  
 Ground terminal(1): M5, Torque (max.) 26.58 lbf-in [3.0 N-m]

2  
Three Phase Filters

3-phase WYE RFI Power Line Filters (continued)

# AYA Series

## 36AYA10



Typical Dimensions:  
 Mounting slots (4): .425 x .254 [10.8 x 6.6]  
 Terminal blocks(8): 10 mm<sup>2</sup> Torque (max.) 15.93 lbf-in [1.8 N-m]  
 Ground terminal(1): M5, Torque (max.) 26.58 lbf-in [3.0 N-m]

## 63AYA10

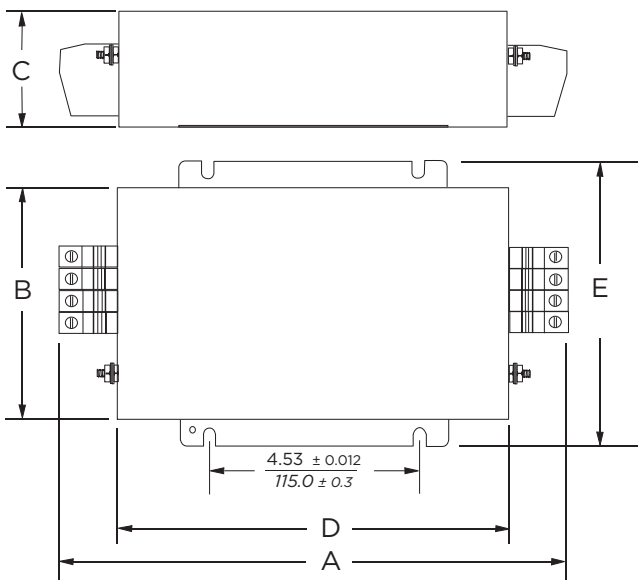

Typical Dimensions:  
 Mounting slots (4): .425 x .254 [10.8 x 6.6]  
 Terminal blocks(8): 16 mm<sup>2</sup> Torque (max.) 20.35 lbf-in [2.3 N-m]  
 Ground terminal(1): M6, Torque (max.) 53.1 lbf-in [6.0 N-m]

### Case Dimensions

| Part No.  | A<br>(max.)  | B<br>(max.) | C<br>(max.) | D<br>(max.) | E*<br>(max.) |
|-----------|--------------|-------------|-------------|-------------|--------------|
| 16AYA6 /A | <b>7.91</b>  | <b>4.37</b> | <b>1.97</b> | <b>5.94</b> | <b>5.51</b>  |
| 25AYA6 /A | 201.0        | 111.0       | 50.0        | 151.0       | 140.0        |
| 36AYA6 /A | <b>7.91</b>  | <b>4.37</b> | <b>2.56</b> | <b>5.94</b> | <b>5.51</b>  |
| 50AYA6 /A | 201.0        | 111.0       | 65.0        | 151.0       | 140.0        |
| 63AYA6 /A | <b>7.91</b>  | <b>4.37</b> | <b>2.56</b> | <b>5.94</b> | <b>5.51</b>  |
| 100AYA6A  | 201.0        | 111.0       | 65.0        | 151.0       | 140.0        |
| 16AYA10   | <b>6.97</b>  | <b>4.37</b> | <b>1.97</b> | <b>5.94</b> | <b>5.51</b>  |
|           | 177.0        | 111.0       | 50.0        | 151.0       | 140.0        |
| 36AYA10   | <b>7.88</b>  | <b>4.37</b> | <b>2.56</b> | <b>5.94</b> | <b>5.51</b>  |
|           | 200.0        | 111.0       | 65.0        | 151.0       | 140.0        |
| 63AYA10   | <b>10.98</b> | <b>5.08</b> | <b>2.95</b> | <b>8.43</b> | <b>6.26</b>  |
|           | 279.0        | 129.0       | 75.0        | 214.0       | 159.0        |

\*Does not apply for bulkhead models

**3-phase WYE RFI Power Line Filters** *(continued)*

# AYA Series

## Performance Data

### Typical Insertion Loss

Measured in closed 50 Ohm system

— Common Mode / Asymmetrical (L-G)  
— Differential Mode / Symmetrical (L-L)

**16AYA**



**25AYA**



**36AYA**

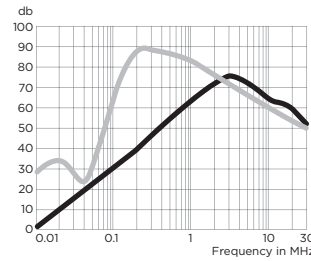

**50AYA**

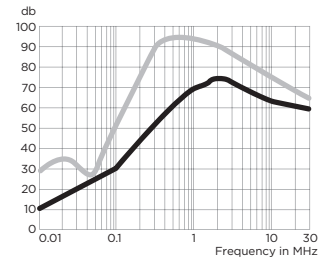

**63AYA**



**100AYA**



### Minimum Insertion Loss

Measured in closed 50 Ohm system

Common Mode / Asymmetrical (Line to Ground)

| Current Rating | Frequency –MHz |     |    |    |    |    |    |    |
|----------------|----------------|-----|----|----|----|----|----|----|
|                | .01            | .05 | .1 | .5 | 1  | 5  | 10 | 30 |
| 16A            | 2              | 11  | 19 | 52 | 53 | 70 | 61 | 30 |
| 25A            | 2              | 12  | 19 | 46 | 49 | 64 | 54 | 27 |
| 36A            | 1              | 10  | 18 | 49 | 54 | 63 | 57 | 32 |
| 50A            | 1              | 8   | 14 | 43 | 47 | 63 | 53 | 29 |
| 63A            | 2              | 10  | 22 | 50 | 60 | 75 | 70 | 55 |
| 100A           | 1              | 15  | 22 | 55 | 60 | 65 | 55 | 50 |

Differential Mode / Symmetrical (Line to Line)

| Current Rating | Frequency –MHz |     |    |    |    |    |    |    |
|----------------|----------------|-----|----|----|----|----|----|----|
|                | .01            | .05 | .1 | .5 | 1  | 5  | 10 | 30 |
| 16A            | 14             | 31  | 30 | 82 | 87 | 76 | 77 | 47 |
| 25A            | 20             | 36  | 38 | 85 | 81 | 68 | 69 | 33 |
| 36A            | 20             | 39  | 36 | 86 | 78 | 65 | 62 | 35 |
| 50A            | 20             | 30  | 38 | 85 | 82 | 67 | 66 | 38 |
| 63A            | 30             | 40  | 45 | 90 | 85 | 70 | 70 | 60 |
| 100A           | 20             | 35  | 45 | 80 | 80 | 65 | 60 | 55 |

**3-phase WYE RFI Power Line Filters for High Noise Applications**

# AYC Series



UL Recognized\*



150AYC10B

## AYC Series

- For 3-phase, four wire, WYE applications
- Very high attenuation
- Low leakage current
- Ideal for EMC troubleshooting and refurbishing in the field
- Touch safe terminals provide easy connections and prevent inadvertent contact for safety in the most demanding applications

## Ordering Information

150 AYC 10 B -95



## Available Part Numbers

|          |              |
|----------|--------------|
| 16AYC10B | 110AYC10B    |
| 25AYC10B | 150AYC10B    |
| 36AYC10B | 150AYC10B-95 |
| 63AYC10B | 180AYC10B    |
| 80AYC10B | 200AYC10B    |

## Specifications

### Maximum leakage current each Line to Ground:

|                | 120 VAC 60Hz | 277 VAC 50Hz |
|----------------|--------------|--------------|
| 16A            | 62 mA        | 106 mA       |
| 25 & 36A       | 68 mA        | 118 mA       |
| 63A            | 74 mA        | 128 mA       |
| 80, 100 & 150A | 74 mA        | 129 mA       |
| 180, 200A      | 111 mA       | 192 mA       |

### Hipot rating (one minute):

|                  |          |
|------------------|----------|
| Line to Ground:  | 1850 VDC |
| Line to Line:    | 1850 VDC |
| Line to Neutral: | 1450 VDC |

### Rated Voltage (max):

|                  |         |
|------------------|---------|
| Phase to Phase:  | 480 VAC |
| Phase to Ground: | 277 VAC |

### Operating Frequency:

50/60 Hz

### Rated Current:

16 to 200A

### Operating Ambient Temperature Range

(at rated current  $I_r$ ): -10°C to +40°C  
In an ambient temperature ( $T_a$ ) higher than +40°C the maximum operating current ( $I_o$ ) is calculated as follows:  $I_o = I_r \sqrt{(85-T_a)/45}$

## Electrical Schematic



\*All except 200AYC10B

**3-phase WYE RFI Filters for High Noise Applications** *(continued)*

# AYC Series

## Case Styles

16, 25, 36, 63AYC10B



80, 110, 150AYC10B / -95



180, 200AYC10B



## Case Dimensions

| Part No.               | A<br>(max.)           | B<br>(max.)          | C<br>(max.)          | D<br>(max.)          | E<br>$\pm 0.078$<br>$\pm .2$ |
|------------------------|-----------------------|----------------------|----------------------|----------------------|------------------------------|
| 16AYC10B               | <b>6.69</b><br>170.0  | <b>4.37</b><br>111.0 | <b>2.56</b><br>65.0  | <b>4.92</b><br>125.0 | <b>2.76</b><br>70.0          |
| 25AYC10B               | <b>9.96</b><br>246.0  | <b>5.08</b><br>129.0 | <b>2.52</b><br>64.0  | <b>5.71</b><br>145.0 | <b>4.53</b><br>115.0         |
| 36AYC10B               | <b>10.35</b><br>263.0 | <b>5.08</b><br>129.0 | <b>2.52</b><br>64.0  | <b>5.71</b><br>145.0 | <b>4.53</b><br>115.0         |
| 63AYC10B               | <b>10.98</b><br>279.0 | <b>5.08</b><br>129.0 | <b>2.95</b><br>75.0  | <b>5.71</b><br>145.0 | <b>4.53</b><br>115.0         |
| 80, 110 &<br>150AYC10B | <b>12.09</b><br>307.0 | <b>5.55</b><br>141.0 | <b>5.55</b><br>141.0 | <b>6.10</b><br>155.0 | <b>4.53</b><br>115.0         |
| 150AYC10B-95           | <b>12.59</b><br>320.0 | <b>5.55</b><br>141.0 | <b>5.55</b><br>141.0 | <b>6.10</b><br>155.0 | <b>4.53</b><br>115.0         |
| 180AYC10B              | <b>15.71</b>          | <b>5.55</b>          | <b>5.55</b>          | <b>6.10</b>          | <b>3.25</b>                  |
| 200AYC10B              | <b>399.0</b>          | <b>141.0</b>         | <b>141.0</b>         | <b>155.0</b>         | <b>82.5</b>                  |

## Terminals

| Part No.  | Terminal    | Size                                | Torque max.<br>lbf-in [N·m] |
|---|-------------|-------------------------------------|-----------------------------|
| <b>16AYC10B</b>                                 | Ground      | M5                                  | 26.58 [3.0]                 |
|   | Line / Load | 4mm <sup>2</sup><br>terminal block  | 7.08 [0.8]                  |
| <b>25AYC10B</b>                                 | Ground      | M5                                  | 26.58 [3.0]                 |
|   | Line / Load | 6mm <sup>2</sup><br>terminal block  | 15.93 [7.8]                 |
| <b>36AYC10B</b>                                 | Ground      | M5                                  | 26.58 [3.0]                 |
|   | Line / Load | 10mm <sup>2</sup><br>terminal block | 15.93 [7.8]                 |
| <b>63AYC10B</b>                                 | Ground      | M6                                  | 53.1 [6.0]                  |
|   | Line / Load | 16mm <sup>2</sup><br>terminal block | 20.35 [2.3]                 |
| <b>80, 110,<br/>150AYC10B</b>                   | Ground      | M10                                 | 177.0 [20.0]                |
|   | Line / Load | 50mm <sup>2</sup><br>terminal block | 70.80 [8.0]                 |
| <b>150AYC10B-95<br/>180AYC10B<br/>200AYC10B</b> | Ground      | M10                                 | 177.0 [20.0]                |
|   | Line / Load | 95mm <sup>2</sup><br>terminal block | 177.0 [20.0]                |

**3-phase WYE RFI Filters for High Noise Applications** *(continued)*

# AYC Series

## Performance Data

### Typical Insertion Loss

Measured in closed 50 Ohm system

**16AYC10B**



**25AYC10B**



**36AYC10B**



**63AYC10B**



**80AYC10B**



**110AYC10B**



**150AYC10B**



**180, 200AYC10B**



— Common Mode / Asymmetrical (L-G)  
— Differential Mode / Symmetrical (L-L)

### Minimum Insertion Loss

Measured in closed 50 Ohm system

Common Mode / Asymmetrical (Line to Ground)

| Part No.       | Frequency –MHz |     |    |    |    |    |    |    |
|----------------|----------------|-----|----|----|----|----|----|----|
|                | .01            | .05 | .1 | .5 | 1  | 5  | 10 | 30 |
| 16AYC10B       | 23             | 66  | 82 | 88 | 82 | 79 | 55 | 21 |
| 25AYC10B       | 26             | 68  | 83 | 93 | 88 | 68 | 45 | 4  |
| 36AYC10B       | 18             | 61  | 78 | 96 | 91 | 71 | 49 | 7  |
| 63AYC10B       | 11             | 57  | 72 | 90 | 86 | 68 | 44 | 4  |
| 80AYC10B       | 10             | 57  | 75 | 84 | 77 | 75 | 62 | 45 |
| 110AYC10B      | 10             | 51  | 60 | 88 | 84 | 74 | 50 | 12 |
| 150AYC10B      | -              | 50  | 57 | 82 | 79 | 75 | 51 | 7  |
| 150AYC10B-95   | 1              | 51  | 55 | 85 | 82 | 84 | 51 | 11 |
| 180, 200AYC10B | 3              | 53  | 55 | 97 | 89 | 81 | 56 | 20 |

Differential Mode / Symmetrical (Line to Line)

| Part No.       | Frequency –MHz |     |    |     |    |    |    |    |
|----------------|----------------|-----|----|-----|----|----|----|----|
|                | .01            | .05 | .1 | .5  | 1  | 5  | 10 | 30 |
| 16AYC10B       | 21             | 32  | 54 | 90  | 86 | 73 | 72 | 47 |
| 25AYC10B       | 23             | 33  | 60 | 100 | 95 | 87 | 70 | 38 |
| 36AYC10B       | 25             | 37  | 51 | 94  | 87 | 69 | 58 | 17 |
| 63AYC10B       | 27             | 45  | 41 | 84  | 77 | 63 | 61 | 43 |
| 80AYC10B       | 37             | 42  | 67 | 87  | 80 | 66 | 60 | 50 |
| 110AYC10B      | 27             | 35  | 39 | 75  | 72 | 51 | 44 | 31 |
| 150AYC10B      | 28             | 37  | 42 | 74  | 67 | 52 | 45 | 30 |
| 150AYC10B-95   | 28             | 40  | 42 | 73  | 66 | 51 | 44 | 31 |
| 180, 200AYC10B | 30             | 41  | 50 | 70  | 64 | 49 | 42 | 26 |



**Compact Low Current 3-phase WYE RFI Filters**

# AYO Series



UL Recognized  
CSA Certified  
VDE Approved



## AYO Series

- For 3-phase, four wire, WYE applications
- Filters each of the three lines plus neutral
- Good for attenuation beginning at 100kHz
- Space saving design
- Low leakage current
- Easy to connect terminals

## Ordering Information



## Available Part Numbers

|        |        |
|--------|--------|
| 3AYO1  | 6AYO1  |
| 10AYO1 | 20AYO1 |

## Specifications

**Maximum leakage current each Line to Ground:**

|                  |                  |            |
|------------------|------------------|------------|
|                  | <u>3, 6, 10A</u> | <u>20A</u> |
| @ 120 VAC 60 Hz: | 2.0 mA           | 3.5 mA     |
| @ 250 VAC 50 Hz: | 3.0 mA           | 5.5 mA     |

**Hipot rating (one minute):**

|                 |          |
|-----------------|----------|
| Line to Ground: | 1500 VAC |
| Line to Line:   | 1450 VDC |

**Rated Voltage (max):**

|                            |         |
|----------------------------|---------|
| Phase to Phase:            | 440 VAC |
| Phase to Neutral / Ground: | 250 VAC |

**Operating Frequency:**

50/60 Hz

**Rated Current:**

3 to 20A

**Operating Ambient Temperature Range**

(at rated current  $I_r$ ): -10°C to +40°C  
In an ambient temperature ( $T_a$ ) higher than +40°C the maximum operating current ( $I_o$ ) is calculated as follows:  $I_o = I_r \sqrt{(85-T_a)/45}$

## Electrical Schematic



**Compact Low Current 3-phase WYE RFI Filters** *(continued)*

# AYO Series

## Case Style



Typical Dimensions:

- Line/Load Terminals (8): .250 [6.3] with .07 [1.8] Dia. hole
- Ground Terminal (1): .250 [6.3] with .07 x .16 [1.8 x 3.8] slot
- Mounting Holes (2): .188 [4.78] Dia.

## Case Dimensions

| Part No.   | A<br>(max.) | B<br>(max.) | C<br>(max.) | D<br>$\pm 0.15$<br>$\pm .38$ | E<br>(max.) |
|------------|-------------|-------------|-------------|------------------------------|-------------|
| AYO Series | 3.37        | 2.07        | 1.53        | 2.938                        | 3.35        |
|            | 85.6        | 52.5        | 38.7        | 74.63                        | 85.1        |

## Performance Data

### Typical Insertion Loss

Measured in closed 50 Ohm system

**3AYO1**



**6AYO1**



**10AYO1**



**20AYO1**



— Common Mode / Asymmetrical (L-G)  
— Differential Mode / Symmetrical (L-L)

### Minimum Insertion Loss

Measured in closed 50 Ohm system

Common Mode / Asymmetrical (Line to Ground)

| Current Rating | Frequency –MHz |    |    |    |    |    |
|----------------|----------------|----|----|----|----|----|
|                | .15            | .5 | 1  | 5  | 10 | 30 |
| 3A             | 12             | 23 | 29 | 33 | 38 | 35 |
| 6A             | 7              | 23 | 30 | 40 | 50 | 30 |
| 10A            | -              | -  | 5  | 16 | 28 | 15 |
| 20A            | -              | 7  | 11 | 32 | 23 | 12 |

Differential Mode / Symmetrical (Line to Line)

| Current Rating | Frequency –MHz |    |    |    |    |    |
|----------------|----------------|----|----|----|----|----|
|                | .15            | .5 | 1  | 5  | 10 | 30 |
| 3A             | -              | 12 | 20 | 50 | 35 | 30 |
| 6A             | 10             | 18 | 24 | 31 | 28 | 28 |
| 10A            | 10             | 18 | 24 | 42 | 28 | 22 |
| 20A            | 10             | 18 | 24 | 42 | 38 | 23 |

**Compact 3-phase Delta RFI Filters for Universal Applications**

# BCF Series



UL Recognized  
VDE Approved



## BCF Series

- Designed for universal applications
- Compact book-form design
- Low weight
- Insulated, high quality safety terminals for input and output
- Cost-effective design
- Good common and differential mode performance below 100kHz
- Applications include; 3-phase inverters, converters, variable speed motor drives and process automation equipment
- Touch safe terminals provide easy connections and prevent inadvertent contact for safety in the most demanding applications

## Ordering Information



## Available Part Numbers

|          |          |
|----------|----------|
| 7BCF10   | 16BCF10  |
| 30BCF10  | 42BCF10  |
| 55BCF10  | 75BCF10  |
| 100BCF10 | 130BCF10 |
| 180BCF10 |          |

## Specifications

- Maximum leakage current each Line to Ground\*:**  
 @ 277 VAC 50 Hz: 30 mA  
*\*If 2 phases are interrupted, this leakage current may rise to a significantly higher level*
- Hipot rating (one minute):**  
 Line to Ground: 1850 VAC  
 Line to Line: 1850 VDC
- Rated Voltage (max):**  
 Phase to Phase: 480 VAC  
 Phase to Ground: 277 VAC
- Operating Frequency:** 50/60 Hz
- Rated Current:** 7 to 180A
- Operating Ambient Temperature Range (at rated current I<sub>r</sub>):** -10°C to +50°C  
 In an ambient temperature (T<sub>a</sub>) higher than +50°C the maximum operating current (I<sub>O</sub>) is calculated as follows:  $I_O = I_r \sqrt{(85-T_a)/35}$

## Electrical Schematic



2  
Three Phase Filters

**Compact 3-phase Delta Filters for Universal Applications** *(continued)*

# BCF Series

## Case Style



## Terminals

| Part No.           | Ground Terminals | Line/Load Terminals |
|--------------------|------------------|---------------------|
| 7BCF10, 16BCF10    | M5               | 4mm <sup>2</sup>    |
| 30BCF10            | M5               | 10mm <sup>2</sup>   |
| 42BCF10            | M6               | 10mm <sup>2</sup>   |
| 55BCF10            | M6               | 16mm <sup>2</sup>   |
| 75BCF10            | M6               | 25mm <sup>2</sup>   |
| 100BCF10, 130BCF10 | M10              | 50mm <sup>2</sup>   |
| 180BCF10           | M10              | 95mm <sup>2</sup>   |

## Case Dimensions

| Part No. | A<br><i>(max.)</i>           | B<br><i>(max.)</i>          | C<br><i>(max.)</i>          | D<br><i>(max.)</i>           | E<br><i>(max.)</i>       | F<br><i>(max.)</i>         | G<br><i>(max.)</i>           | H<br><i>(max.)</i>       |
|----------|------------------------------|-----------------------------|-----------------------------|------------------------------|--------------------------|----------------------------|------------------------------|--------------------------|
| 7BCF10   | <b>6.30</b><br><i>160.0</i>  | <b>1.57</b><br><i>40.0</i>  | <b>2.76</b><br><i>70.0</i>  | <b>7.48</b><br><i>190.0</i>  | <b>.03</b><br><i>.8</i>  | <b>.79</b><br><i>20.0</i>  | <b>7.09</b><br><i>180.0</i>  | <b>.18</b><br><i>4.5</i> |
| 16BCF10  | <b>8.66</b><br><i>220.0</i>  | <b>1.77</b><br><i>45.0</i>  | <b>2.76</b><br><i>70.0</i>  | <b>9.84</b><br><i>250.0</i>  | <b>.03</b><br><i>.8</i>  | <b>.98</b><br><i>25.0</i>  | <b>9.25</b><br><i>235.0</i>  | <b>.21</b><br><i>5.4</i> |
| 30BCF10  | <b>9.45</b><br><i>240.0</i>  | <b>1.97</b><br><i>50.0</i>  | <b>3.35</b><br><i>85.0</i>  | <b>10.63</b><br><i>270.0</i> | <b>.03</b><br><i>.8</i>  | <b>1.18</b><br><i>30.0</i> | <b>10.04</b><br><i>255.0</i> | <b>.21</b><br><i>5.4</i> |
| 42BCF10  | <b>11.02</b><br><i>280.0</i> | <b>1.97</b><br><i>50.0</i>  | <b>3.35</b><br><i>85.0</i>  | <b>12.20</b><br><i>310.0</i> | <b>.03</b><br><i>.8</i>  | <b>1.18</b><br><i>30.0</i> | <b>11.61</b><br><i>295.0</i> | <b>.21</b><br><i>5.4</i> |
| 55BCF10  | <b>8.66</b><br><i>220.0</i>  | <b>3.35</b><br><i>85.0</i>  | <b>3.54</b><br><i>90.0</i>  | <b>9.84</b><br><i>250.0</i>  | <b>.04</b><br><i>1.0</i> | <b>2.36</b><br><i>60.0</i> | <b>9.25</b><br><i>235.0</i>  | <b>.21</b><br><i>5.4</i> |
| 75BCF10  | <b>9.45</b><br><i>240.0</i>  | <b>3.15</b><br><i>80.0</i>  | <b>5.31</b><br><i>135.0</i> | <b>10.63</b><br><i>270.0</i> | <b>.04</b><br><i>1.0</i> | <b>2.36</b><br><i>60.0</i> | <b>10.04</b><br><i>255.0</i> | <b>.26</b><br><i>6.5</i> |
| 100BCF10 | <b>9.45</b><br><i>240.0</i>  | <b>3.54</b><br><i>90.0</i>  | <b>5.91</b><br><i>150.0</i> | <b>10.63</b><br><i>270.0</i> | <b>.04</b><br><i>1.0</i> | <b>2.56</b><br><i>65.0</i> | <b>10.04</b><br><i>255.0</i> | <b>.26</b><br><i>6.5</i> |
| 130BCF10 | <b>9.45</b><br><i>240.0</i>  | <b>3.54</b><br><i>90.0</i>  | <b>5.91</b><br><i>150.0</i> | <b>10.63</b><br><i>270.0</i> | <b>.04</b><br><i>1.0</i> | <b>2.56</b><br><i>65.0</i> | <b>10.04</b><br><i>255.0</i> | <b>.26</b><br><i>6.5</i> |
| 180BCF10 | <b>13.78</b><br><i>350.0</i> | <b>4.72</b><br><i>120.0</i> | <b>6.69</b><br><i>170.0</i> | <b>14.96</b><br><i>380.0</i> | <b>.04</b><br><i>1.0</i> | <b>4.2</b><br><i>102.0</i> | <b>14.37</b><br><i>365.0</i> | <b>.26</b><br><i>6.5</i> |

**Compact 3-phase Delta Filters for Universal Applications** *(continued)*

# BCF Series

## Performance Data

### Typical Insertion Loss

Measured in closed 50 Ohm system

**7BCF10**



**16BCF10**



**30BCF10**



**42BCF10**



**55BCF10**



**75BCF10**



**100BCF10**



**130BCF10**



— Common Mode / Asymmetrical (L-G)  
— Differential Mode / Symmetrical (L-L)

**180BCF10**



### Minimum Insertion Loss

Measured in closed 50 Ohm system

Common Mode / Asymmetrical (Line to Ground)

| Current Rating | Frequency –MHz |     |     |    |     |    |    |    |    |    |    |    |
|----------------|----------------|-----|-----|----|-----|----|----|----|----|----|----|----|
|                | .01            | .03 | .05 | .1 | .15 | .3 | .5 | 1  | 3  | 5  | 10 | 30 |
| 7A             | 18             | 39  | 48  | 62 | 68  | 89 | 96 | 83 | 62 | 53 | 41 | 20 |
| 16A            | 17             | 37  | 45  | 58 | 65  | 85 | 96 | 88 | 65 | 56 | 43 | 23 |
| 30A            | 16             | 36  | 44  | 58 | 64  | 82 | 90 | 74 | 56 | 48 | 36 | 18 |
| 42A            | 12             | 30  | 40  | 52 | 61  | 79 | 90 | 72 | 54 | 47 | 35 | 18 |
| 55A            | 16             | 35  | 44  | 58 | 66  | 87 | 87 | 67 | 47 | 38 | 26 | 12 |
| 75A            | 12             | 30  | 40  | 53 | 60  | 84 | 90 | 70 | 50 | 42 | 30 | 15 |
| 100A           | 12             | 29  | 38  | 50 | 59  | 79 | 80 | 67 | 49 | 40 | 29 | 15 |
| 130A           | 11             | 26  | 35  | 48 | 55  | 78 | 83 | 67 | 49 | 40 | 29 | 15 |
| 180A           | 11             | 27  | 36  | 49 | 57  | 72 | 77 | 61 | 47 | 40 | 29 | 15 |

Differential Mode / Symmetrical (Line to Line)

| Current Rating | Frequency –MHz |     |     |    |     |    |    |    |    |    |    |    |
|----------------|----------------|-----|-----|----|-----|----|----|----|----|----|----|----|
|                | .01            | .03 | .05 | .1 | .15 | .3 | .5 | 1  | 3  | 5  | 10 | 30 |
| 7A             | 16             | 23  | 28  | 54 | 67  | 89 | 85 | 76 | 67 | 62 | 57 | 46 |
| 16A            | 18             | 26  | 24  | 48 | 58  | 78 | 82 | 80 | 74 | 71 | 65 | 51 |
| 30A            | 23             | 31  | 29  | 49 | 62  | 87 | 84 | 78 | 68 | 64 | 59 | 46 |
| 42A            | 13             | 35  | 36  | 50 | 67  | 88 | 82 | 69 | 59 | 55 | 50 | 40 |
| 55A            | 27             | 35  | 35  | 51 | 68  | 87 | 83 | 71 | 61 | 58 | 54 | 31 |
| 75A            | 27             | 35  | 35  | 50 | 66  | 87 | 86 | 72 | 62 | 58 | 53 | 35 |
| 100A           | 28             | 37  | 38  | 47 | 70  | 73 | 76 | 78 | 68 | 64 | 58 | 34 |
| 130A           | 27             | 37  | 40  | 38 | 53  | 75 | 80 | 64 | 54 | 50 | 47 | 30 |
| 180A           | 27             | 37  | 40  | 42 | 50  | 73 | 73 | 60 | 50 | 47 | 42 | 30 |

**3-phase Delta Power Line Filter for High Voltage Applications**

# CFN Series



UL Recognized\*



## CFN Series

- Universal high current filter
- Suitable for industrial applications including; motor drives, inverters, converters, uninterruptible power supplies and mining equipment

## Ordering Information



## Available Part Numbers

|          |          |
|----------|----------|
| 300CFN12 | 400CFN12 |
| 500CFN12 | 600CFN12 |

*\*400CFN12 only*

## Specifications

**Maximum leakage current at 10% unsymmetrical mains Line to Ground (3 Phase WYE Center tapped)\*:**

- @ 120 VAC 60 Hz: 5.0 mA
- @ 277 VAC 50 Hz: 9.6 mA

*\*If 2 phases are interrupted, this leakage current may rise to a significantly higher level*

**Hipot rating (one minute):**

- Line to Ground: 2210 VDC
- Line to Line: 2158 VDC

**Rated Voltage (max):**

- Phase to Phase: 480 VAC
- Phase to Ground: 277 VAC

**Operating Frequency:**

50/60 Hz

**Rated Current:**

300 to 600A

**Operating Ambient Temperature Range**

(at rated current  $I_r$ ): -10°C to +40°C  
In an ambient temperature ( $T_a$ ) higher than +40°C the maximum operating current ( $I_o$ ) is calculated as follows:  $I_o = I_r \sqrt{(85 - T_a) / 45}$

## Electrical Schematic



**3-phase Delta Power Filter for High Voltage Applications** *(continued)*

# CFN Series

## Case Style



## Case Dimensions

| Part No.     | A<br>(max.)                 | B<br>(max.)                  | C<br>(max.)                 | D1<br>(ref.)                 | D2<br>(max.)                 | E<br>$\pm .02$<br>$\pm .50$  | F<br>(max)                  | G<br>$\pm .02$<br>$\pm .50$ | H<br>(max.)                |
|--------------|-----------------------------|------------------------------|-----------------------------|------------------------------|------------------------------|------------------------------|-----------------------------|-----------------------------|----------------------------|
| 300-600CFN12 | <b>24.8</b><br><i>630.0</i> | <b>11.81</b><br><i>300.0</i> | <b>6.30</b><br><i>160.0</i> | <b>22.20</b><br><i>564.0</i> | <b>20.31</b><br><i>516.0</i> | <b>10.83</b><br><i>275.0</i> | <b>9.84</b><br><i>250.0</i> | <b>8.66</b><br><i>220.0</i> | <b>5.0</b><br><i>127.0</i> |

## Performance Data

### Typical Insertion Loss

Measured in closed 50 Ohm system

#### 300-600CFN12



— Common Mode / Asymmetrical (L-G)  
- - - Differential Mode / Symmetrical (L-L)

### Minimum Insertion Loss

Measured in closed 50 Ohm system

Common Mode / Asymmetrical (Line to Ground)

| Current Rating | Frequency –MHz |     |     |    |     |    |    |    |    |    |
|----------------|----------------|-----|-----|----|-----|----|----|----|----|----|
|                | .01            | .03 | .07 | .1 | .15 | .5 | 1  | 5  | 10 | 30 |
| 300-600A       | 10             | 19  | 26  | 40 | 55  | 82 | 76 | 51 | 37 | 20 |

Differential Mode / Symmetrical (Line to Line)

| Current Rating | Frequency –MHz |     |     |    |     |    |    |    |    |    |
|----------------|----------------|-----|-----|----|-----|----|----|----|----|----|
|                | .01            | .03 | .07 | .1 | .15 | .5 | 1  | 5  | 10 | 30 |
| 300-600A       | 32             | 40  | 27  | 55 | 70  | 66 | 57 | 40 | 34 | 20 |

**3-phase Delta External Power Line Filter for Frequency Converters**

# FCD Series



UL Recognized



6FCD10

## FCD Series

- Suitable to meet the latest EMC standards
- Insulated safety terminals
- Suitable for EMC troubleshooting in the field
- Very high attenuation
- High insertion loss
- BS models optimized for very high insertion loss
- BS models suitable for infeed/regenerative (ER) applications
- Touch safe terminals provide easy connections and prevent inadvertent contact for safety in the most demanding applications

## Ordering Information



## Specifications

### Maximum leakage current

#### voltage drop to virtual N to PE/V:

|                   |           |
|-------------------|-----------|
| 6FCD10:           | .26 mA/V  |
| 12 & 16FCD10:     | .45 mA/V  |
| 25, 36 & 50FCD10: | .52 mA/V  |
| 12 & 16FCD10B:    | .46 mA/V  |
| 25 & 36FCD10B:    | .52 mA/V  |
| 50FCD10B:         | .57 mA/V  |
| 80 & 110FCD10B:   | .62 mA/V  |
| 150FCD10B:        | .63 mA/V  |
| 180 & 230FCD10B:  | .92 mA/V  |
| FCD10BS:          | 3.25 mA/V |

### Hipot rating (one minute):

|                 |          |
|-----------------|----------|
| Line to Ground: | 2250 VDC |
| Line to Line:   | 1450 VDC |

### Rated Voltage (max):

|                            |         |
|----------------------------|---------|
| Phase to Phase:            | 480 VAC |
| Phase to Neutral / Ground: | 277 VAC |

### Operating Frequency:

50/60 Hz

### Rated Current:

6 to 230A

### Operating Ambient Temperature Range

(at rated current  $I_r$ ): -10°C to +40°C

In an ambient temperature ( $T_a$ ) higher than +40°C the maximum operating current ( $I_o$ ) is calculated as follows:  $I_o = I_r \sqrt{(85-T_a)/45}$

## Electrical Schematics

### 6FCD10





**3-phase Delta External Filter for Frequency Converters** *(continued)*

# FCD Series

## Electrical Schematics *(continued)*

### 12 to 50A FCD10



### 12 to 50A FCD10B



### 80 to 230A FCD10B



### FCD10BS



## Available Part Numbers

|         |              |               |
|---------|--------------|---------------|
| 6FCD10  | 12FCD10B     | 50FCD10BS     |
| 12FCD10 | 16FCD10B     | 80FCD10BS     |
| 16FCD10 | 25FCD10B     | 110FCD10BS    |
| 25FCD10 | 36FCD10B     | 150FCD10BS    |
| 36FCD10 | 50FCD10B     | 150FCD10BS-95 |
| 50FCD10 | 80FCD10B     | 180FCD10BS    |
|         | 110FCD10B    | 230FCD10BS    |
|         | 150FCD10B    |               |
|         | 150FCD10B-95 |               |
|         | 180FCD10B    |               |
|         | 230FCD10B    |               |

## Case Styles

### 6 to 50A FCD10 & FCD10B



### 80 to 150A FCD10B 50 to 150A FCD10BS



**3-phase Delta External Filter for Frequency Converters** *(continued)*

# FCD Series

## Case Styles *(continued)* 180 to 230FCD10B\BS



### Terminals

| Part No.  | Terminal  | Size                                | Torque max.<br>lbf-in [N·m] |
|---|-----------|-------------------------------------|-----------------------------|
| 6FCD10  | Ground    | 8-32                                | 20.7 [2.34]                 |
|   | Line/Load | 4mm <sup>2</sup><br>terminal block  | 7.08 [0.8]                  |
| 12FCD10/10B<br>16FCD10/10B                      | Ground    | M5                                  | 26.58 [3.0]                 |
|   | Line/Load | 4mm <sup>2</sup><br>terminal block  | 7.08 [0.8]                  |
| 25FCD10/10B<br>36FCD10/10B                      | Ground    | M5                                  | 26.58 [3.0]                 |
|   | Line/Load | 6mm <sup>2</sup><br>terminal block  | 15.93 [1.8]                 |
| 50FCD10/10B                                     | Ground    | M5                                  | 26.58 [3.0]                 |
|   | Line/Load | 10mm <sup>2</sup><br>terminal block | 15.93 [1.8]                 |
| 50FCD10BS                                       | Ground    | M10                                 | 88.5 [10.0]                 |
|   | Line/Load | 16mm <sup>2</sup><br>terminal block | 20.36 [2.3]                 |
| 80 to 150FCD10B<br>80 to 150FCD10BS             | Ground    | M10                                 | 88.5 [10.0]                 |
|   | Line/Load | 50mm <sup>2</sup><br>terminal block | 70.80 [8.0]                 |
| 150FCD10B/BS-95<br>180FCD10B/BS<br>230FCD10B/BS | Ground    | M10                                 | 88.5 [10.0]                 |
|   | Line/Load | 95mm <sup>2</sup><br>terminal block | 177.0 [20.0]                |

### Case Dimensions

| Part No.                                    | A<br>(max.) | B<br>(max.) | C<br>(max.) | D<br>$\pm .02$<br>$\pm .5$ | E<br>(max.) | F<br>$\pm .02$<br>$\pm .5$ |
|---|-------------|-------------|-------------|----------------------------|-------------|----------------------------|
| 6FCD10                                      | 6.18        | 4.33        | 2.32        | 3.74                       | 5.16        | 2.76                       |
| 12FCD10/10B<br>16FCD10/10B                  | 157.0       | 110.0       | 59.0        | 95.0                       | 131.0       | 70.0                       |
| 25FCD10/10B<br>36FCD10/10B<br>50FCD10/10B   | 6.97        | 5.51        | 2.56        | 4.92                       | 5.94        | 2.76                       |
| 50FCD10BS                                   | 177.0       | 140.0       | 65.0        | 125.0                      | 151.0       | 70.0                       |
| 80FCD10B/BS<br>110FCD10B/BS<br>150FCD10B/BS | 9.69        | 6.26        | 2.52        | 5.71                       | 8.43        | 4.53                       |
| 150FCD10B-95<br>150FCD10BS-95               | 246.0       | 159.0       | 64.0        | 145.0                      | 214.0       | 115.0                      |
| 180FCD10B/BS<br>230FCD10B/BS                | 11.41       | 6.61        | 3.54        | 6.10                       | 8.70        | 4.53                       |
| 50FCD10BS                                   | 290.0       | 168.0       | 90.0        | 155.0                      | 221.0       | 115.0                      |
| 80FCD10B/BS<br>110FCD10B/BS<br>150FCD10B/BS | 12.09       | 6.61        | 5.55        | 6.10                       | 8.70        | 4.53                       |
| 150FCD10B-95<br>150FCD10BS-95               | 307.0       | 168.0       | 141.0       | 155.0                      | 221.0       | 115.0                      |
| 180FCD10B/BS<br>230FCD10B/BS                | 15.71       | 6.61        | 5.55        | 6.10                       | 11.81       | 6.50                       |
|   | 399.0       | 168.0       | 141.0       | 155.0                      | 300.0       | 165.0                      |

### Performance Data

#### Typical Insertion Loss

Measured in closed 50 Ohm system

6FCD10



12FCD10



— Common Mode / Asymmetrical (L-G)  
— Differential Mode / Symmetrical (L-L)

**3-phase Delta External Filter for Frequency Converters** *(continued)*

# FCD Series

## Performance Data *(continued)*

### Typical Insertion Loss *(continued)*

Measured in closed 50 Ohm system

**16FCD10**



**25FCD10**



**36FCD10**



**50FCD10**



**12FCD10B**



**16FCD10B**



**25FCD10B**



**36FCD10B**



**50FCD10B**



**80FCD10B**



**110FCD10B**



**150FCD10B**



**180FCD10B**



**230FCD10B**



**50/80/110FCD10BS**



**150FCD10BS**



**180FCD10BS**



**230FCD10BS**



— Common Mode / Asymmetrical (L-G)  
— Differential Mode / Symmetrical (L-L)

**3-phase Delta External Filter for Frequency Converters** *(continued)*

# FCD Series

## Performance Data *(continued)*

### Minimum Insertion Loss

Measured in closed 50 Ohm system

Common Mode / Asymmetrical (Line to Ground)

| Part No.     | Frequency –MHz |     |     |    |    |    |    |    |    |
|--------------|----------------|-----|-----|----|----|----|----|----|----|
|              | .01            | .03 | .05 | .1 | .5 | 1  | 5  | 10 | 30 |
| 6FCD10       | 2              | 14  | 23  | 39 | 56 | 52 | 48 | 45 | 33 |
| 12 & 16FCD10 | 13             | 30  | 36  | 45 | 75 | 75 | 52 | 45 | 35 |
| 25FCD10      | 13             | 30  | 36  | 45 | 75 | 75 | 52 | 45 | 35 |
| 36FCD10      | 9              | 26  | 32  | 40 | 75 | 75 | 52 | 45 | 35 |
| 50FCD10      | 9              | 26  | 32  | 40 | 75 | 75 | 52 | 45 | 35 |
| 12FCD10B     | 18             | 45  | 59  | 75 | 73 | 65 | 49 | 47 | 26 |
| 16FCD10B     | 18             | 45  | 59  | 75 | 73 | 65 | 49 | 47 | 26 |
| 25FCD10B     | 18             | 45  | 60  | 49 | 83 | 75 | 58 | 56 | 28 |
| 36FCD10B     | 8              | 38  | 52  | 70 | 77 | 70 | 54 | 50 | 47 |
| 50FCD10B     | 3              | 34  | 49  | 67 | 76 | 70 | 59 | 58 | 37 |
| 80FCD10B     | 2              | 35  | 49  | 67 | 74 | 67 | 59 | 58 | 27 |
| 110FCD10B    | 2              | 35  | 49  | 66 | 72 | 65 | 59 | 58 | 18 |
| 150FCD10B    | 1              | 36  | 50  | 66 | 69 | 63 | 59 | 58 | 9  |
| 180FCD10B    | -              | 36  | 50  | 66 | 67 | 60 | 59 | 58 | -  |
| 230FCD10B    | -              | 25  | 40  | 58 | 73 | 66 | 58 | 52 | 21 |
| 50FCD10BS    | 40             | 66  | 70  | 69 | 65 | 60 | 53 | 51 | 24 |
| 80FCD10BS    | 35             | 63  | 67  | 66 | 63 | 58 | 52 | 49 | 23 |
| 110FCD10BS   | 30             | 61  | 69  | 69 | 66 | 60 | 53 | 53 | 25 |
| 150FCD10BS   | 32             | 61  | 67  | 67 | 62 | 56 | 48 | 46 | 16 |
| 180FCD10BS   | 30             | 60  | 65  | 65 | 61 | 55 | 47 | 46 | 16 |
| 230FCD10BS   | 27             | 58  | 62  | 63 | 59 | 54 | 46 | 45 | 15 |

Differential Mode / Symmetrical (Line to Line)

| Part No.     | Frequency –MHz |     |     |    |    |    |    |    |    |
|--------------|----------------|-----|-----|----|----|----|----|----|----|
|              | .01            | .03 | .05 | .1 | .5 | 1  | 5  | 10 | 30 |
| 6FCD10       | 9              | 8   | 24  | 40 | 62 | 57 | 50 | 48 | 38 |
| 12 & 16FCD10 | 9              | 13  | 24  | 55 | 75 | 75 | 75 | 65 | 60 |
| 25FCD10      | 9              | 13  | 26  | 55 | 75 | 75 | 75 | 65 | 60 |
| 36FCD10      | 9              | 13  | 26  | 46 | 75 | 75 | 75 | 65 | 60 |
| 50FCD10      | 9              | 13  | 26  | 46 | 75 | 75 | 75 | 65 | 60 |
| 12FCD10B     | 6              | 13  | 9   | 37 | 90 | 86 | 74 | 78 | 34 |
| 16FCD10B     | 6              | 13  | 9   | 37 | 60 | 86 | 74 | 78 | 34 |
| 25FCD10B     | 10             | 16  | 12  | 41 | 89 | 87 | 69 | 86 | 43 |
| 36FCD10B     | 17             | 24  | 24  | 38 | 87 | 81 | 63 | 66 | 24 |
| 50FCD10B     | 15             | 24  | 27  | 21 | 88 | 74 | 51 | 69 | 52 |
| 80FCD10B     | 17             | 25  | 28  | 23 | 87 | 71 | 50 | 62 | 45 |
| 110FCD10B    | 18             | 27  | 30  | 25 | 86 | 69 | 49 | 56 | 39 |
| 150FCD10B    | 19             | 28  | 31  | 28 | 85 | 66 | 49 | 49 | 32 |
| 180FCD10B    | 21             | 29  | 33  | 30 | 84 | 63 | 48 | 43 | 26 |
| 230FCD10B    | 22             | 31  | 35  | 36 | 78 | 60 | 46 | 41 | 26 |
| 50FCD10BS    | 25             | 31  | 26  | 59 | 73 | 64 | 50 | 45 | 19 |
| 80FCD10BS    | 25             | 31  | 26  | 59 | 73 | 64 | 50 | 45 | 19 |
| 110FCD10BS   | 24             | 31  | 24  | 55 | 72 | 65 | 51 | 46 | 26 |
| 150FCD10BS   | 25             | 33  | 32  | 51 | 71 | 61 | 47 | 42 | 22 |
| 180FCD10BS   | 25             | 33  | 32  | 51 | 71 | 61 | 47 | 42 | 22 |
| 230FCD10BS   | 25             | 33  | 32  | 51 | 71 | 61 | 47 | 42 | 22 |

---

**Engineering Notes**

---



---

**Engineering Notes**

---



**3. Power Inlet Filters & Power Entry Modules – Table of Contents**

Introduction .....126

Selector Chart .....128

Power Entry Module Selector Guide .....129

    C Series .....130

    CU Series .....134

    EBF Series .....138

    EC Series .....141

    ED Series .....144

    EEA & EEB Series .....148

        EAS & EBS Models .....148

        EAH & EBH Models .....148

    EEJ Series .....153

        EJH & EJHS Models .....153

        EJM & EJMS Models .....153

        EJS Models .....153

    EF Series .....160

    EJT Series .....163

    GG & HG Series .....166

    H Series .....169

    J Series .....172

    L Series .....175

    LA Series .....180

    M Series .....183

    P Series .....192

    SR Series .....201

    SRB Series .....203



## Introduction



Corcom EJS Series  
IEC Inlet RFI Filter

**Power Inlet Filters** feature power sockets integrated with EMI filters enclosed in RFI jackets. The AC power socket complies with IEC an standard to assure worldwide power cord compatibility. These filters are available in a wide variety of filtering, shielding, mounting and termination styles that provide the most compact and cost-effective inlet filtering available. For DC power inlet filters, see the DC section.



Corcom P Series CHAMELEON  
Power Entry Module

**Power Entry Modules** incorporate power sockets with filtering, fuses, switching and voltage selection in a variety of configurations to reduce cost, space and labor. The power sockets comply with IEC standards to assure worldwide AC power cord compatibility. For DC power entry modules, see the DC section.

Equipment marketed worldwide, must operate with

- Multiple different wall plugs and sockets
- Different fuse standards in America and Europe
- Different voltages in different regions
- On/Off switching options
- Different EMI requirements in different regions

**The combinations are endless. Your equipment needs a single solution.**

TE Connectivity's power entry modules can provide ONE mechanical solution for a variety of power entry needs. Each series supports several different configurations to suit the market requirements. Each starts with an international standard power cord connector, and includes options for fusing, voltage selection, switching, and filtering. Selecting one power entry module series simplifies the mechanical design, and each version within the series replaces the cost and labor of up to including up to five individual parts in the equipment bill of materials. With hundreds of different combinations of power entry functions, the modules in this catalog offer a cost-effective solution to the power entry needs of many systems. It is easy to select the module that best serves your needs.



## Introduction *(continued)*

The selector guides on the next two pages help you configure the best power entry module for your application. Just select options from this menu of five categories.

**IEC60320-1 Socket** – Common to all modules, the 60320-1 universal socket allows your equipment to be used in every country. Simply select a power cord with a mating IEC 60320-1 plug on one end, and a regionally appropriate plug on the other.

**Fusing Options** – North American ( $\frac{1}{4}$ " x  $\frac{1}{4}$ " 3AG) or Metric (5mm x 20mm) or both? One fuse or two?

**Voltage Selection Options** – 4-voltage, 2-voltage, or 1-voltage? Multitap? Center-tap? Dual primary?

**Power Switch** – Yes or no? Double pole (DPST) or single (SPST)? These power entry module switches feature international on - off markings, current ratings up to 15A and high inrush current.

**Shielding** – reduce radiated emissions through the panel cut-out by selecting a module with a shield (optional on the C, CU, M and P).

**Filtering options** – Choice of six filter circuits (all with low leakage current to meet international standards) to fit specific filtering objectives:

- **General purpose** (C, CU, GG, J, LA, M and P) – most cost-effective, for susceptibility and for high-frequency “clean-up” when used with a board-level filter
- **Medical** (in C, GG, L, M, and P series) – for medical equipment
- **Emissions/Linear** (in L and P series) – capable of bringing most digital equipment with linear power supplies into FCC compliance
- **Emissions/SMPS-FCC** (in P, LA and M series) – capable of bringing most digital equipment with switch-mode power supplies into FCC Class B compliance
- **Emissions/SMPS-VDE** (in P, LA and M series) – capable of bringing most digital equipment with switch-mode power supplies into VDE level B (as well as FCC Class B) compliance

Want more filtering options? Select a general purpose or an unfiltered module (C, CU, J, L, M, P, or SR series) and wire it up connect it to the load through one of the many Corcom chassis-mounted filter of your choice from the choices found in this comprehensive catalog. TE’s Corcom product engineers can also design a custom filter for your specific applicaiton.

Available accessories expand your options even further. A Corcom product sales engineer can assist you with selecting the right filter for your application.

Having arrived at the best possible combination of power entry elements, TE’s worldwide agency approvals will help ease your product through the necessary safety agencies. File numbers and Safety Agency information is listed in Section 7.

**Selector Chart**



**Power Entry Module Selector Guide**

| Series  | Unfiltered    |                     | Filtered      |                     |   | Options       |                    |                          |
|---|---------------|---------------------|---------------|---------------------|---|---------------|--------------------|--------------------------|
|   | Product Photo | Max. Current Rating | Product Photo | Max. Current Rating | Filter Type   | On/Off Switch | Voltage Selections | Fuse Holder              |
| <b>C</b>  |               | 15A<br><b>NEW</b>   |               | 10A                 | Medical & General Purpose                           | Yes DPST      | N/A                | N/A                      |
| <b>CU</b><br><b>NEW</b>   |               | 15A                 |               | 15A                 | General Purpose                                     | Yes SPST      | N/A                | N/A                      |
| <b>GG</b>   | Filtered Only |                     |               | 10A                 | Medical & General Purpose                           | N/A           | N/A                | Metric                   |
| <b>L</b>  |               | 6A                  |               | 6A                  | Medical & General Purpose                           | Optional DPST | Single or 4        | North American or Metric |
| <b>M</b>  |               | 6A                  |               | 6A                  | Medical, General Purpose & Switch Mode Power Supply | Optional DPST | Single, 2 or 4     | North American or Metric |
| <b>P</b>  |               | 10A                 |               | 10A                 | Medical, General Purpose & Switch Mode Power Supply | Optional DPST | Single or 2        | North American or Metric |
| <b>New High Performance versions in PE and PM Mounting Styles</b> |               |                     |               |                     |   |               |                    |                          |

N/A = Not Available

**Power Entry Module with Switch**

# C Series



UL Recognized  
CSA Certified  
VDE Approved\*



## C Series

- Two function power entry module combining a DPST switch and an IEC 60320-1 inlet
- Snap-in or flange mounting
- Available with or without a shielded general purpose or medical grade filter
- Two element circuit provides enhanced EMI attenuation
- Reduce OEM wiring time with optional pre-connected line and switch terminals

## Ordering Information



\*15A versions are tested by Underwriters Laboratories to US and Canadian requirements and are VDE approved at 10A, 250VAC

## Specifications

### Maximum leakage current each Line to Ground:

|                  | F Models | H & Unfiltered |
|------------------|----------|----------------|
| @ 120 VAC 60 Hz: | .25 mA   | 2 µA           |
| @250 VAC 50 Hz:  | .40 mA   | 5 µA           |

### Hipot rating (one minute):

|                 |          |
|-----------------|----------|
| Line to Ground: | 2250 VDC |
| Line to Line:   | 1450 VDC |

**Rated Voltage:** 250 VAC

**Operating Frequency:** 50/60 Hz

**Rated Current:** 1 to 15A\*

**Switch:** DPST  
10,000 operations at 51A max. inrush

**.250 Terminal Push-on Force:** 18 lb. / 80N (max.)

**.188 Terminal Push-on Force:** 15 lb. / 67N (max.)

## Available Part Numbers

| Filtered Versions     |                         |
|-----------------------|-------------------------|
| 1CHE1                 | 1CFE1                   |
| 3CHE1                 | 3CFE1                   |
| 6CHE1                 | 6CFE1                   |
| 10CHE1                | 10CFE1                  |
| 1CHS1                 | 1CFS1                   |
| 3CHS1                 | 3CFS1                   |
| 6CHS1                 | 6CFS1                   |
| 10CHS1                | 10CFS1                  |
| Non-filtered Versions |                         |
| Standard Terminals    | Pre-connected Terminals |
| 10CS1                 | 10CBS1                  |
| 10CE1                 | 10CBE1                  |
| 15CS1                 | 15CBS1                  |
| 15CE1                 | 15CBE1                  |

**Power Entry Module with Switch** *(continued)*

# C Series

## Electrical Schematics

### F Models



### H Models



### B Models



Note 1: Jumpers provided on CBS and CBE versions only  
Note 2: Location of optional filter

## Case Styles

### CS, CBS



Typical Dimensions:  
Line Inlet (1): IEC 60320-1 C14  
Terminals (6): .187 [4.8] with .055 [1.4] Dia. hole  
Ground Terminal (1): .187 [4.8] with .112 x .06 [2.8 x 1.5] slot

### CE, CBE



Typical Dimensions:  
Mounting holes (2): .13 [3.3] Dia. with .23 [5.9] Dia. x 90° countersink for #4 flathead screw  
Line Inlet (1): IEC 60320-1 C14  
Terminals (6): .187 [4.8] with .055 [1.4] Dia. hole  
Ground Terminal (1): .187 [4.8] with .112 x .06 [2.8 x 1.5] slot

### CFS, CHS



Typical Dimensions:  
Line Inlet (1): IEC 60320-1 C14  
Terminals (3): .25 [6.35] with .07 [1.8] Dia. hole

### CFE, CHE



Typical Dimensions:  
Mounting holes (2): .13 [3.3] Dia. with .23 [5.9] Dia. x 90° countersink for #4 flathead screw  
Line Inlet (1): IEC 60320-1 C14  
Terminals (3): .25 [6.35] with .07 [1.8] Dia. hole

**Power Entry Module with Switch** *(continued)*

# C Series

## Case Styles *(continued)*

### CBS, CBE Pre-Connected Terminals



CBS, CBE Side View

CBE Rear View

CBS Rear View

### Recommended Panel Cutout



Panel Thickness: .031 - .098 [0.8 - 2.5]  
 Not recommended for plastic panels.  
 Snap-in models suitable for front mounting only.  
 For Snap-in applications, the D sides of the cutout must have a .02 [.508] radius on the installation side.

## Case Dimensions

| Part No. | A<br>(max.)         | B<br>(max.)         | C<br>(max.)         | D<br>$\pm .01$<br>$\pm .254$ | E<br>$\pm .01$<br>$\pm .254$ | F<br>$\pm .006$<br>$\pm .152$ |
|----------|---------------------|---------------------|---------------------|------------------------------|------------------------------|-------------------------------|
| CS, CBS  | <b>1.22</b><br>31.0 | <b>.93</b><br>23.6  | <b>1.62</b><br>41.2 | <b>1.06</b><br>26.92         | <b>1.54*</b><br>39.12*       | -                             |
| CE, CBE  | <b>1.74</b><br>44.2 | <b>.93</b><br>23.6  | <b>1.62</b><br>41.2 | <b>1.06</b><br>26.92         | <b>1.56</b><br>39.62         | <b>1.417</b><br>36.0          |
| CFS, CHS | <b>1.22</b><br>31.0 | <b>2.53</b><br>64.3 | <b>1.62</b><br>41.2 | <b>1.12</b><br>28.5          | <b>1.54*</b><br>39.12*       | -                             |
| CFE, CHE | <b>1.74</b><br>44.2 | <b>2.53</b><br>64.3 | <b>1.62</b><br>41.2 | <b>1.12</b><br>28.5          | <b>1.56</b><br>39.62         | <b>1.417</b><br>36.0          |

\*+ .000 [.000] / - .008 [.20]

## Accessories

GA400: NEMA 5-15P to IEC 60320-1 C-13 line cord



**Power Entry Module with Switch** *(continued)*

# C Series

## Performance Data

### Typical Insertion Loss

Measured in closed 50 Ohm system

**1CF**



**3CF**



**6CF**



**10CF**



**1CH**



**3CH**



**6CH**



**10CH**



— Common Mode / Asymmetrical (L-G)  
— Differential Mode / Symmetrical (L-L)

### Minimum Insertion Loss

Measured in closed 50 Ohm system

**Common Mode / Asymmetrical (Line to Ground)**

| Current Rating  | Frequency – MHz |     |    |    |    |    |    |
|-----------------|-----------------|-----|----|----|----|----|----|
|                 | .05             | .15 | .5 | 1  | 5  | 10 | 30 |
| <b>F Models</b> |                 |     |    |    |    |    |    |
| 1A              | 10              | 26  | 46 | 48 | 46 | 47 | 46 |
| 3A              | 8               | 16  | 32 | 36 | 43 | 48 | 50 |
| 6A              | 4               | 11  | 22 | 27 | 36 | 41 | 50 |
| 10A             | 1               | 4   | 14 | 18 | 27 | 33 | 42 |
| <b>H Models</b> |                 |     |    |    |    |    |    |
| 1A              | 16              | 21  | 37 | 44 | 26 | 21 | 10 |
| 3A              | 9               | 14  | 31 | 32 | 26 | 24 | 14 |
| 6A              | 4               | 10  | 22 | 23 | 19 | 18 | 13 |
| 10A             | 2               | 6   | 10 | 15 | 11 | 11 | 9  |

**Differential Mode / Symmetrical (Line to Line)**

| Current Rating  | Frequency – MHz |     |    |    |    |    |    |
|-----------------|-----------------|-----|----|----|----|----|----|
|                 | .05             | .15 | .5 | 1  | 5  | 10 | 30 |
| <b>F Models</b> |                 |     |    |    |    |    |    |
| 1A              | 1               | 3   | 13 | 28 | 62 | 67 | 42 |
| 3A              | 2               | 6   | 14 | 23 | 65 | 65 | 67 |
| 6A              | 2               | 6   | 14 | 27 | 46 | 48 | 58 |
| 10A             | 1               | 7   | 14 | 23 | 42 | 44 | 62 |
| <b>H Models</b> |                 |     |    |    |    |    |    |
| 1A              | 1               | 6   | 13 | 29 | 38 | 42 | 26 |
| 3A              | 1               | 5   | 10 | 22 | 36 | 34 | 36 |
| 6A              | 1               | 5   | 14 | 20 | 31 | 33 | 37 |
| 10A             | 1               | 4   | 11 | 19 | 32 | 37 | 38 |

**Compact 1U Height Switched Power Entry Module**

# CU Series



UL Recognized  
CSA Certified  
VDE Approved\*



## CU Series

- Designed for popular 1U (1 3/4") height rack mounted equipment
- Two function power entry module combining a SPST switch and an IEC 60320-1 inlet
- Snap-in, flange and flush mounting
- Reduce OEM wiring time with optional pre-connected line and switch terminals

## Ordering Information

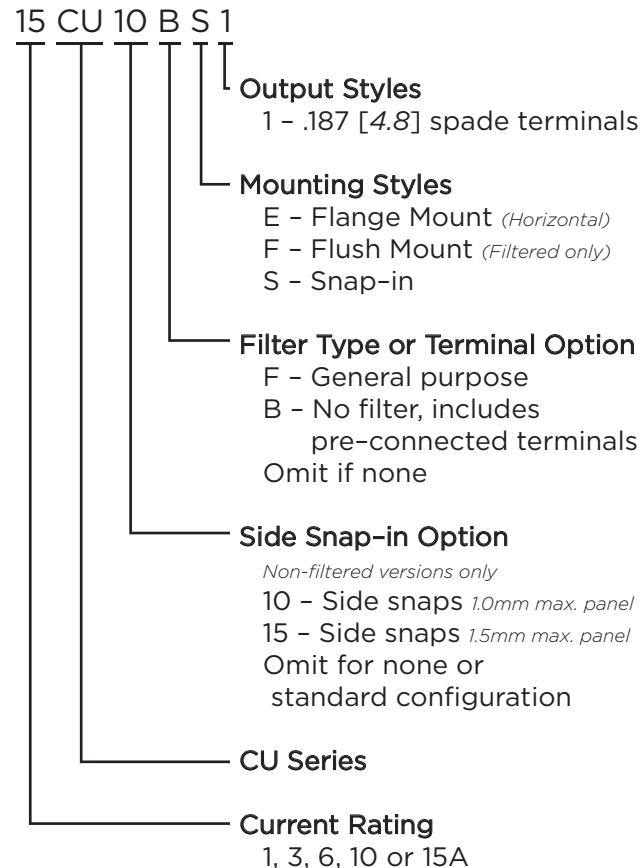

## Specifications

**Maximum leakage current each Line to Ground:**

|                  | <u>Filtered</u> | <u>Unfiltered</u> |
|------------------|-----------------|-------------------|
| @ 120 VAC 60 Hz: | .25 mA          | 2 µA              |
| @250 VAC 50 Hz:  | .40 mA          | 5 µA              |

**Hipot rating (one minute):**

|                 |          |
|-----------------|----------|
| Line to Ground: | 2250 VDC |
| Line to Line:   | 1450 VDC |

**Operating Voltage:**

120/250 VAC

**Operating Frequency:**

50/60 Hz

**Rated Current:**

1 to 15A\*

**Switch:**

50A inrush capable SPST

**Terminal Push-on Force:**

15 lb. / 67N (max.)

## Available Part Numbers

| Filtered Versions     |                         |         |
|-----------------------|-------------------------|---------|
| 1CUFE1                | 1CUFF1                  | 1CUFS1  |
| 3CUFE1                | 3CUFF1                  | 3CUFS1  |
| 6CUFE1                | 6CUFF1                  | 6CUFS1  |
| 10CUFE1               | 10CUFF1                 | 10CUFS1 |
| 15CUFE1               | 15CUFF1                 | 15CUFS1 |
| Non-filtered Versions |                         |         |
| Standard Terminals    | Pre-connected Terminals |         |
| 15CUE1                | 15CUBE1                 |         |
| 15CUS1                | 15CUBS1                 |         |
| 15CU10S1              | 15CU10BS1               |         |
| 15CU15S1              | 15CU15BS1               |         |

*\*15A versions are tested by Underwriters Laboratories to US and Canadian requirements and are VDE approved at 10A, 250VAC*



**Compact 1U Height Switched Power Entry Module** *(continued)*

# CU Series

## Electrical Schematic



## Case Styles

### CUFE1



Typical Dimensions:

|                      |  |
|----------------------|--|
| Mounting holes (2):  | .138 [3.5] Dia. with .228 [5.8] Dia. x 90° countersink for M3 flathead screw |
| Line Inlet (1):      | IEC 60320-1 C14  |
| Terminals (2):       | .187 [4.8] with .055 [1.4] Dia. hole   |
| Ground Terminal (1): | .187 [4.8] with .112 x .06 [2.8 x 1.5] slot                                  |
| Output Shroud:       | .21 x .34 [5.2 x 8.6] inside dimension                                       |

### CUFF1



For rear mounted applications only. Maximum panel thickness: .157 [4.0]

Typical Dimensions:

|                      |   |
|----------------------|---|
| Mounting Holes(2):   | M3 x 0.5 Threaded flange                    |
| Line Inlet (1):      | IEC 60320-1 C14                             |
| Terminals (2):       | .187 [4.8] with .055 [1.4] Dia. hole        |
| Ground Terminal (1): | .187 [4.8] with .112 x .06 [2.8 x 1.5] slot |
| Output Shroud:       | .21 x .34 [5.2 x 8.6] inside dimension      |

### CUFS1



Typical Dimensions:

|                      |   |
|----------------------|---|
| Line Inlet (1):      | IEC 60320-1 C14                             |
| Terminals (2):       | .187 [4.8] with .055 [1.4] Dia. hole        |
| Ground Terminal (1): | .187 [4.8] with .112 x .06 [2.8 x 1.5] slot |
| Output Shroud:       | .21 x .34 [5.2 x 8.6] inside dimension      |

### CUE1



Note: Switch output terminal configuration may vary

Typical Dimensions:

|                      |  |
|----------------------|--|
| Mounting holes (2):  | .138 [3.5] Dia. with .228 [5.8] Dia. x 90° countersink for M3 flathead screw |
| Line Inlet (1):      | IEC 60320-1 C14  |
| Terminals (4):       | .187 [4.8] with .055 [1.4] Dia. hole   |
| Ground Terminal (1): | .187 [4.8] with .112 x .06 [2.8 x 1.5] slot                                  |

### CUS1



Note: Switch output terminal configuration may vary

Typical Dimensions:

|                      |   |
|----------------------|---|
| Line Inlet (1):      | IEC 60320-1 C14                             |
| Terminals (4):       | .187 [4.8] with .055 [1.4] Dia. hole        |
| Ground Terminal (1): | .187 [4.8] with .112 x .06 [2.8 x 1.5] slot |

**Compact 1U Height Switched Power Entry Module** *(continued)*

# CU Series

## Case Styles *(continued)*

### CU10S1 & CU15S1



Available for panel thickness .07 - 1.0mm (CU10S1) or 1.2 - 1.5mm CU15S1  
Note: Switch output terminal configuration may vary

Typical Dimensions:

|                      |   |
|----------------------|---|
| Line Inlet (1):      | IEC 60320-1 C14                             |
| Terminals (4):       | .187 [4.8] with .055 [1.4] Dia. hole        |
| Ground Terminal (1): | .187 [4.8] with .112 x .06 [2.8 x 1.5] slot |

### CUBE1 Pre-Connected Terminals

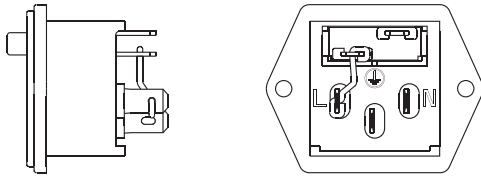

### CUBS1 Pre-Connected Terminals



### CU10BS1 & CU15BS1 Pre-Connected Terminals



## Case Dimensions

| Part No.           | A<br>(max.)         | B<br>(max.)         | C<br>(max.)         | D<br>$\pm .004$<br>$\pm .100$ | E<br>$\pm .004$<br>$\pm .100$ | F<br>$\pm .004$<br>$\pm .100$ |
|--------------------|---------------------|---------------------|---------------------|-------------------------------|-------------------------------|-------------------------------|
| CUFE1              | <b>1.73</b><br>43.9 | <b>1.75</b><br>44.5 | <b>1.34</b><br>34.1 | <b>1.11</b><br>28.1           | <b>1.26</b><br>31.9           | <b>1.45</b><br>36.8           |
| CUFF1              | <b>1.7</b><br>43.1  | <b>1.8</b><br>45.0  | <b>1.34</b><br>34.1 | <b>1.21</b><br>30.8           | <b>1.35</b><br>34.3           | <b>1.45</b><br>36.8           |
| CUFS1              | <b>1.20</b><br>30.6 | <b>1.8</b><br>45.0  | <b>1.34</b><br>34.1 | <b>1.11</b><br>28.1           | <b>1.26</b><br>32.0           | -                             |
| CUE1,<br>CUBE1     | <b>1.73</b><br>43.9 | <b>.96</b><br>24.6  | <b>1.34</b><br>34.1 | <b>1.06</b><br>26.9           | <b>1.09</b><br>27.6           | <b>1.45</b><br>36.8           |
| CUS1,<br>CUBS1     | <b>1.20</b><br>30.6 | <b>0.97</b><br>24.6 | <b>1.34</b><br>34.1 | <b>1.04</b><br>26.4           | <b>1.26</b><br>32.0           | -                             |
| 10CUS1,<br>10CUBS1 | <b>1.20</b><br>30.6 | <b>0.97</b><br>24.6 | <b>1.34</b><br>34.1 | <b>1.05</b><br>26.7           | <b>1.24</b><br>31.6           | -                             |
| 15CUS1,<br>15CUBS1 | <b>1.20</b><br>30.6 | <b>0.97</b><br>24.6 | <b>1.34</b><br>34.1 | <b>1.05</b><br>26.7           | <b>1.24</b><br>31.6           | -                             |

## Recommended Panel Cutout



| Model       | Panel Thickness          | R Dim.      |
|-------------|--------------------------|-------------|
| CUFF1       | .157 [4.0] max.          | 1.8 [45.72] |
| CUFS1, CUS1 | .025 - .082 [0.63 - 2.1] | 1.0 [25.4]  |
| CU10S1      | .028 - .039 [0.7 - 1.0]  | 1.0 [25.4]  |
| CU15S1      | .047 - .059 [1.2 - 1.5]  | 1.0 [25.4]  |

Note 1: CUFF1 allows for back mounting only  
Note 2: All other models allow for front mounting only

## Accessories

**GA400:** NEMA 5-15P to IEC 60320-1 C-13 line cord



**Compact 1U Height Switched Power Entry Module** *(continued)*

# CU Series

## Performance Data

### Typical Insertion Loss

Measured in closed 50 Ohm system

**1CUF**



**3CUF**



**6CUF**



**10CUF**



**15CUF**



— Common Mode / Asymmetrical (L-G)  
— Differential Mode / Symmetrical (L-L)

### Minimum Insertion Loss

Measured in closed 50 Ohm system

Common Mode / Asymmetrical (Line to Ground)

| Current Rating | Frequency – MHz |     |     |    |    |    |    |
|----------------|-----------------|-----|-----|----|----|----|----|
|                | .05             | .15 | .05 | 1  | 5  | 10 | 30 |
| 1A             | 19              | 30  | 44  | 49 | 47 | 44 | 45 |
| 3A             | 13              | 23  | 37  | 43 | 47 | 44 | 49 |
| 6A             | 5               | 14  | 28  | 34 | 43 | 43 | 48 |
| 10A            | 1               | 7   | 19  | 25 | 35 | 36 | 52 |
| 15A            | -               | 1   | 10  | 13 | 25 | 27 | 42 |

Differential Mode / Symmetrical (Line to Line)

| Current Rating | Frequency – MHz |     |     |    |    |    |    |
|----------------|-----------------|-----|-----|----|----|----|----|
|                | .05             | .15 | .05 | 1  | 5  | 10 | 30 |
| 1A             | 1               | 10  | 21  | 26 | 48 | 51 | 60 |
| 3A             | 1               | 10  | 20  | 26 | 42 | 45 | 65 |
| 6A             | 1               | 10  | 20  | 23 | 38 | 41 | 65 |
| 10A            | 1               | 10  | 20  | 23 | 29 | 34 | 56 |
| 15A            | 1               | 10  | 20  | 23 | 28 | 39 | 54 |

Accessory Outlet Filter

# EBF Series



UL Recognized  
CSA Certified  
VDE Approved



## EBF Series

- Accessory IEC 60320-1 C13 filtered outlet
- Allows connection of accessories while filtering noise between a system and the accessory
- Enhanced performance across the frequency range
- Grounded connection
- Suitable for international usage

## Ordering Information



## Specifications

**Maximum leakage current each Line to Ground:**  
 @ 120 VAC 60 Hz: .25 mA  
 @ 250 VAC 50 Hz: .50 mA

**Hipot rating (one minute):**  
 Line to Ground: 2250 VDC  
 Line to Line: 1450 VDC

**Rated Voltage (max.):** 250 VAC

**Operating Frequency:** 50/60 Hz

**Rated Current:** 1 to 10A

**Operating Ambient Temperature Range (at rated  $I_r$ ):** -10°C to +40°C  
 In an ambient temperature ( $T_a$ ) higher than +40°C the maximum operating current ( $I_o$ ) is calculated as follows:  $I_o = I_r \sqrt{(85-T_a)/45}$

## Electrical Schematic

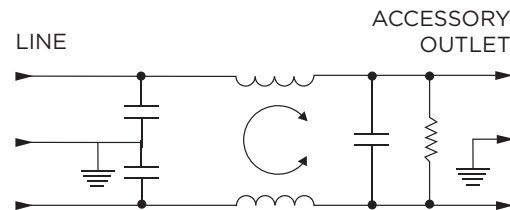

## Available Part Numbers

|        |        |
|--------|--------|
| 1EBF1  | 1EBF4  |
| 3EBF1  | 3EBF4  |
| 6EBF1  | 6EBF4  |
| 10EBF1 | 10EBF4 |

Accessory Outlet Filter *(continued)*

# EBF Series

## Case Styles

### EBF1



Typical Dimensions:

- Mounting holes (2): .132 [3.35] Dia. with .236 [5.99] Dia. x 90° countersink for #4 flathead screw
- Load Outlet (1): IEC 60320-1 C13
- Line Terminals (2): .250 [6.3] with .07 [1.8] Dia. hole
- Ground Terminal (1): .250 [6.3] with .07 x .16 [1.8 x 3.8] slot

### EBF4



Typical Dimensions:

- Mounting holes (2): .132 [3.35] Dia. with .236 [5.99] Dia. x 90° countersink for #4 flathead screw
- Load Outlet (1): IEC 60320-1 C13
- Wire Leads (3): 10.0 [254.0] min., 18AWG, UL1015

## Case Dimensions

| Part No. | A<br>(max.)                 | B<br>(max.)                 | C<br>(max.)                 | D<br>$\pm .01$<br>$\pm .25$  | E<br>(max.)                |
|----------|-----------------------------|-----------------------------|-----------------------------|------------------------------|----------------------------|
| EBF1     | <b>2.57</b><br><i>65.3</i>  | <b>1.33</b><br><i>33.8</i>  | <b>1.00</b><br><i>25.4</i>  | <b>1.575</b><br><i>40.01</i> | <b>1.99</b><br><i>50.5</i> |
| EBF4     | <b>2.09</b><br><i>53.01</i> | <b>1.39</b><br><i>35.31</i> | <b>1.16</b><br><i>29.46</i> | <b>1.575</b><br><i>40.01</i> | <b>1.99</b><br><i>50.5</i> |

## Recommended Panel Cutout



Front Mount Only  
Tolerance + .008 [.203] / - .000 [.000]

Accessory Outlet Filter *(continued)*

# EBF Series

## Performance Data

### Typical Insertion Loss

Measured in closed 50 Ohm system

1EBF



3EBF



6EBF



10EBF



— Common Mode / Asymmetrical (L-G)  
— Differential Mode / Symmetrical (L-L)

### Minimum Insertion Loss

Measured in closed 50 Ohm system

Common Mode / Asymmetrical (Line to Ground)

| Current Rating | Frequency – MHz |     |    |    |    |    |    |
|----------------|-----------------|-----|----|----|----|----|----|
|                | .05             | .15 | .5 | 1  | 5  | 10 | 30 |
| 1A             | 23              | 32  | 41 | 47 | 47 | 47 | 40 |
| 3A             | 10              | 19  | 30 | 36 | 48 | 50 | 47 |
| 6A             | 1               | 10  | 22 | 28 | 42 | 48 | 47 |
| 10A            | 1               | 5   | 14 | 20 | 32 | 38 | 47 |

Differential Mode / Symmetrical (Line to Line)

| Current Rating | Frequency – MHz |     |    |    |    |    |    |
|----------------|-----------------|-----|----|----|----|----|----|
|                | .05             | .15 | .5 | 1  | 5  | 10 | 30 |
| 1A             | 3               | 14  | 23 | 41 | 47 | 50 | 44 |
| 3A             | 2               | 11  | 14 | 25 | 38 | 44 | 40 |
| 6A             | 2               | 10  | 14 | 20 | 33 | 42 | 40 |
| 10A            | 2               | 10  | 16 | 19 | 19 | 39 | 40 |

High Performance EMI Power Inlet Filter

# EC Series



UL Recognized  
CSA Certified  
VDE Approved



## EC Series

- Three element differential mode circuit provides the highest attenuation of any available standard inlet filter
- High common mode inductance
- High differential mode capacitance
- Effective attenuation of Line to Ground and Line to Line noise across the frequency range
- Performance and application similar to the ED series but with higher differential mode performance
- Includes several termination options

## Ordering Information



## Specifications

- Maximum leakage current each Line to Ground:**
- @ 120 VAC 60 Hz: .25 mA
  - @ 250 VAC 50 Hz: .50 mA
- Hipot rating (one minute):**
- Line to Ground: 2250 VDC
  - Line to Line: 1450 VDC
- Rated Voltage (max.):** 250 VAC
- Operating Frequency:** 50/60 Hz
- Rated Current:** 1 to 10A
- Operating Ambient Temperature Range (at rated current I<sub>r</sub>):** -10°C to +40°C
- In an ambient temperature (T<sub>a</sub>) higher than +40°C the maximum operating current (I<sub>O</sub>) is calculated as follows:  $I_O = I_r \sqrt{(85-T_a)/45}$

## Electrical Schematic



## Available Part Numbers

|       |      |      |      |
|-------|------|------|------|
| 1EC1  | 1EC2 | 1EC4 | 1EC8 |
| 3EC1  | 3EC2 | 3EC4 | 3EC8 |
| 6EC1  | 6EC2 | 6EC4 | 6EC8 |
| 10EC1 |      |      |      |

High Performance EMI Power Inlet Filter *(continued)*

# EC Series

## Case Styles

### EC1

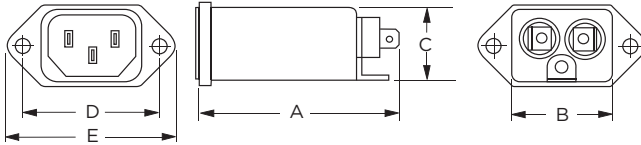

### EC2

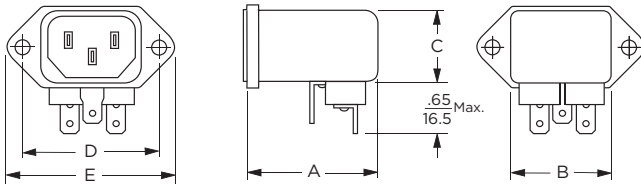

Typical Dimensions:

- Line Inlet (1): IEC 60320-1 C14
- Load Terminals (2): .250 [6.3] with .07 [1.8] Dia. hole
- Ground Terminal (1): .250 [6.3] with .07 x .16 [1.8 x 3.8] slot

### EC4

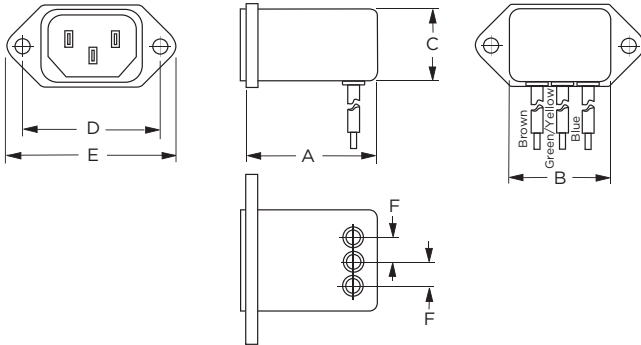

### EC8

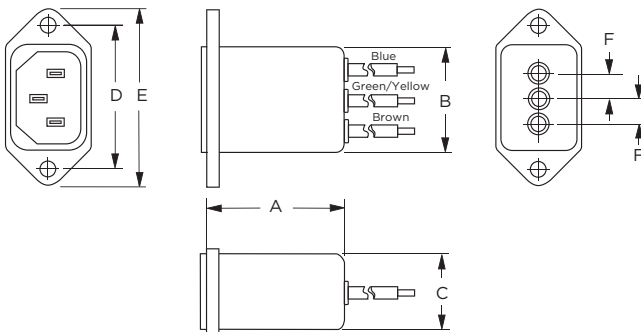

Typical Dimensions:

- Line Inlet (1): IEC 60320-1 C14
- Wire Leads: 4.0 [101.6] Min., 18AWG, UL1015

## Case Dimensions

| Part No. | A (max.)            | B (max.)            | C (max.)            | D $\pm .015$<br>$\pm .38$ | E (max.)            | F (ref.)           |
|----------|---------------------|---------------------|---------------------|---------------------------|---------------------|--------------------|
| EC1      | <b>2.62</b><br>66.5 | <b>1.19</b><br>30.2 | <b>0.81</b><br>20.6 | <b>1.575</b><br>40.01     | <b>1.98</b><br>50.3 | -                  |
| EC2      | <b>1.97</b><br>50.0 | <b>1.19</b><br>30.2 | <b>0.85</b><br>21.6 | <b>1.575</b><br>40.01     | <b>1.98</b><br>50.3 | -                  |
| EC4      | <b>1.97</b><br>50.0 | <b>1.19</b><br>30.2 | <b>0.85</b><br>21.6 | <b>1.575</b><br>40.01     | <b>1.98</b><br>50.3 | <b>.295</b><br>7.5 |
| EC8      | <b>1.98</b><br>50.0 | <b>1.19</b><br>30.2 | <b>0.81</b><br>20.6 | <b>1.575</b><br>40.01     | <b>1.98</b><br>50.3 | <b>.298</b><br>7.5 |

## Recommended Panel Cutouts

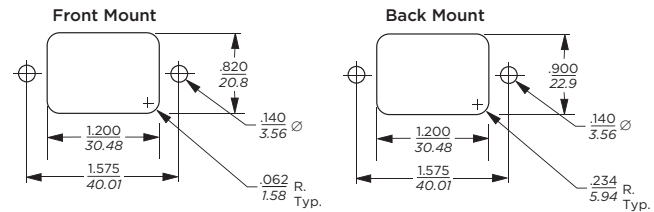

Tolerances  $\pm .005$  [0.13] unless otherwise noted

- Note 1: EC1 and EC8 allow for front or back mounting
- Note 2: EC2 and EC4 allow for back mounting only

## Accessories

GA400: NEMA 5-15P to IEC 60320-1 C-13 line cord

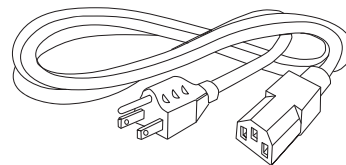

FA601: Insulating Shroud





**High Performance EMI Power Inlet Filter** *(continued)*

# EC Series

## Performance Data

### Typical Insertion Loss

Measured in closed 50 Ohm system

**1EC**



**3EC**



**6EC**



**10EC**



— Common Mode / Asymmetrical (L-G)  
— Differential Mode / Symmetrical (L-L)

### Minimum Insertion Loss

Measured in closed 50 Ohm system

Common Mode / Asymmetrical (Line to Ground)

| Current Rating | Frequency – MHz |    |    |    |    |    |
|----------------|-----------------|----|----|----|----|----|
|                | .15             | .5 | 1  | 5  | 10 | 30 |
| 1A             | 25              | 35 | 40 | 50 | 50 | 50 |
| 3A             | 20              | 30 | 37 | 47 | 48 | 50 |
| 6A             | 15              | 22 | 25 | 40 | 45 | 50 |
| 10A            | 7               | 14 | 20 | 35 | 39 | 48 |

Differential Mode / Symmetrical (Line to Line)

| Current Rating            | Frequency – MHz |    |    |    |    |    |    |
|---------------------------|-----------------|----|----|----|----|----|----|
|                           | .15             | .5 | 1  | 5  | 10 | 20 | 30 |
| <b>EC1, EC2 &amp; EC8</b> |                 |    |    |    |    |    |    |
| 1A                        | 5               | 35 | 50 | 60 | 60 | 40 | 40 |
| 3A                        | 5               | 25 | 45 | 60 | 55 | 34 | 34 |
| 6A                        | 10              | 10 | 40 | 65 | 60 | 40 | 40 |
| 10A                       | 10              | 10 | 27 | 65 | 56 | 38 | 38 |
| <b>EC4</b>                |                 |    |    |    |    |    |    |
| 1A                        | 5               | 35 | 50 | 60 | 60 | 33 | 33 |
| 3A                        | 5               | 30 | 45 | 60 | 55 | 34 | 34 |
| 6A                        | 10              | 10 | 40 | 65 | 60 | 33 | 33 |

Medium Performance Compact EMI Power Inlet Filter

# ED Series



UL Recognized  
CSA Certified  
VDE Approved\*



## ED Series

- Two element circuit provides medium attenuation
- Available with an internal ground-circuit inductor (C versions) to isolate equipment chassis from power line ground at radio frequencies
- Versions up to 15A\*
- Similar to EEJ Series with alternative termination options
- See the EC Series for better differential mode performance

## Ordering Information



\*15A versions are tested by Underwriters Laboratories to US and Canadian requirements and are VDE approved at 10A, 250VAC

## Specifications

**Maximum leakage current each Line to Ground:**  
 @ 120 VAC 60 Hz: .22 mA  
 @ 250 VAC 50 Hz: .38 mA

**Hipot rating (one minute):**  
 Line to Ground: 2250 VDC  
 Line to Line: 1450 VDC

**Rated Voltage (max.):** 250 VAC

**Operating Frequency:** 50/60 Hz

**Rated Current:** 1 to 15A\*

**Operating Ambient Temperature Range (at rated current I<sub>r</sub>):** -10°C to +40°C  
 In an ambient temperature (T<sub>a</sub>) higher than +40°C the maximum operating current (I<sub>O</sub>) is calculated as follows:  $I_O = I_r \sqrt{(85 - T_a) / 45}$

## Available Part Numbers

|                                  |      |       |       |
|----------------------------------|------|-------|-------|
| 1ED1                             | 1ED2 | 1ED4  | 1ED8  |
| 3ED1                             | 3ED2 | 3ED4  | 3ED8  |
| 6ED1                             | 6ED2 | 6ED4  | 6ED8  |
| 10ED1                            |      |       |       |
| 15ED1                            |      |       | 15ED8 |
| Ground Circuit Inductor Versions |      |       |       |
| 6ED1C                            |      | 6ED4C | 6ED8C |
| 10ED1C                           |      |       |       |

## Electrical Schematic

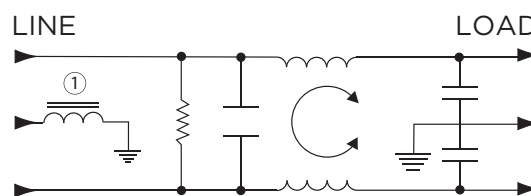

Note 1: C versions only

Medium Performance Compact EMI Power Inlet Filter (continued)

# ED Series

## Case Styles

### ED1 & ED1C



Typical Dimensions:  
 Mounting holes (2): .132 [3.35] Dia. with .236 [5.99] Dia. x 90° countersink for #4 flathead screw  
 Line Inlet (1): IEC 60320-1 C14  
 Load Terminals (2): .250 [6.3] with .07 [1.8] Dia. hole  
 Ground Terminal (1): .250 [6.3] with .07 x .16 [1.8 x 3.8] slot

### ED2



Typical Dimensions:  
 Mounting holes (2): .132 [3.35] Dia. with .236 [5.99] Dia. x 90° countersink for #4 flathead screw  
 Line Inlet (1): IEC 60320-1 C14  
 Load Terminals (2): .250 [6.3] with .07 [1.8] Dia. hole  
 Ground Terminal (1): .250 [6.3] with .07 x .16 [1.8 x 3.8] slot

### ED4 & ED4C



Typical Dimensions:  
 Mounting holes (2): .132 [3.35] Dia. with .236 [5.99] Dia. x 90° countersink for #4 flathead screw  
 Line Inlet (1): IEC 60320-1 C14  
 Wire Leads: 4.0 [101.6] Min., 18AWG, UL1015

### ED8 & ED8C



Typical Dimensions:  
 Mounting holes (2): .132 [3.35] Dia. with .236 [5.99] Dia. x 90° countersink for #4 flathead screw  
 Line Inlet (1): IEC 60320-1 C14  
 Wire Leads: 4.0 [101.6] Min., 18AWG, UL1015

## Case Dimensions

| Part No.         | A<br>(max.) | B<br>(max.) | C<br>(max.) | D<br>$\pm .015$<br>$\pm .38$ | E<br>(max.) | F<br>(ref.) |
|------------------|-------------|-------------|-------------|------------------------------|-------------|-------------|
| 1ED1, 3ED1, 6ED1 | <b>2.21</b> | <b>1.19</b> | <b>0.81</b> | <b>1.575</b>                 | <b>1.98</b> | -           |
| 1ED2, 3ED2, 6ED2 | <b>1.55</b> | <b>1.19</b> | <b>0.85</b> | <b>1.575</b>                 | <b>1.98</b> | -           |
| 1ED4, 3ED4, 6ED4 | <b>1.55</b> | <b>1.19</b> | <b>0.85</b> | <b>1.575</b>                 | <b>1.98</b> | <b>.295</b> |
| 1ED8, 3ED8, 6ED8 | <b>1.55</b> | <b>1.19</b> | <b>0.81</b> | <b>1.575</b>                 | <b>1.98</b> | <b>.295</b> |
| 6ED1C            | <b>2.62</b> | <b>1.19</b> | <b>0.81</b> | <b>1.575</b>                 | <b>1.98</b> | -           |
| 6ED4C            | <b>1.98</b> | <b>1.19</b> | <b>0.85</b> | <b>1.575</b>                 | <b>1.98</b> | <b>.295</b> |
| 6ED8C            | <b>1.98</b> | <b>1.19</b> | <b>0.81</b> | <b>1.575</b>                 | <b>1.98</b> | <b>.295</b> |
| 10ED1 /1C, 15ED1 | <b>2.62</b> | <b>1.19</b> | <b>0.81</b> | <b>1.575</b>                 | <b>1.98</b> | -           |
| 15ED8            | <b>1.98</b> | <b>1.19</b> | <b>0.81</b> | <b>1.575</b>                 | <b>1.98</b> | -           |

Medium Performance Compact EMI Power Inlet Filter *(continued)*

# ED Series

## Recommended Panel Cutouts



Note 1: ED1 and ED8 allow for front or back mounting  
Note 2: ED2 and ED4 allow for back mounting only

## Accessories

GA400: NEMA 5-15P to IEC 60320-1 C-13 line cord



FA601: Insulating Shroud



## Performance Data

### Typical Insertion Loss

Measured in closed 50 Ohm system

1ED



3ED



6ED



6ED1C



10ED1 & 10ED1C



15ED



— Common Mode / Asymmetrical (L-G)  
— Differential Mode / Symmetrical (L-L)

**Medium Performance Compact EMI Power Inlet Filter** *(continued)*

# ED Series

## Performance Data *(continued)*

### Minimum Insertion Loss

Measured in closed 50 Ohm system

Common Mode / Asymmetrical (Line to Ground)

| Current Rating                 | Frequency – MHz |    |    |    |    |    |
|--------------------------------|-----------------|----|----|----|----|----|
|                                | .15             | .5 | 1  | 5  | 10 | 30 |
| <b>ED1, ED2, ED4 &amp; ED8</b> |                 |    |    |    |    |    |
| 1A                             | 24              | 35 | 42 | 49 | 52 | 54 |
| 3A                             | 20              | 29 | 36 | 45 | 50 | 54 |
| 6A                             | 14              | 23 | 30 | 41 | 45 | 50 |
| 10A                            | 8               | 14 | 20 | 35 | 39 | 45 |
| 15A                            | 4               | 9  | 12 | 28 | 34 | 40 |
| <b>ED1C</b>                    |                 |    |    |    |    |    |
| 6A                             | 14              | 20 | 25 | 37 | 42 | 50 |
| 10A                            | 8               | 14 | 20 | 35 | 39 | 45 |
| <b>ED4C &amp; ED8C</b>         |                 |    |    |    |    |    |
| 6A                             | 14              | 20 | 25 | 37 | 42 | 50 |

Differential Mode / Symmetrical (Line to Line)

| Current Rating                 | Frequency – MHz |    |    |    |    |    |
|--------------------------------|-----------------|----|----|----|----|----|
|                                | .15             | .5 | 1  | 5  | 10 | 30 |
| <b>ED1, ED2, ED4 &amp; ED8</b> |                 |    |    |    |    |    |
| 1A                             | 3               | 15 | 20 | 37 | 37 | 36 |
| 3A                             | 3               | 15 | 20 | 37 | 37 | 36 |
| 6A                             | 3               | 15 | 20 | 31 | 35 | 34 |
| 10A                            | 6               | 15 | 20 | 23 | 44 | 47 |
| 15A                            | 6               | 18 | 23 | 33 | 44 | 47 |
| <b>ED1C</b>                    |                 |    |    |    |    |    |
| 6A                             | 7               | 17 | 23 | 36 | 42 | 42 |
| 10A                            | 6               | 15 | 20 | 23 | 44 | 47 |
| <b>ED4C &amp; ED8C</b>         |                 |    |    |    |    |    |
| 6A                             | 7               | 17 | 23 | 29 | 38 | 42 |



**Cost-effective EMI Power Inlet Filter**

# EEA & EEB Series

Including the EAS/EBS and EAH/EBH Models



**UL Recognized  
CSA Certified  
VDE Approved**



## EEA Series

- Compact single stage EMI filter with IEC 60320-1 C14 inlet
- Two element circuit provides basic attenuation
- Same performance as the EF Series
- Available in three terminal configurations
- Supersedes EF Series

## EEB Series

- Compact EMI filter with IEC 60320-1 C14 inlet
- Two element circuit provides extended attenuation
- Extended differential mode performance
- Available in three terminal configurations

## EAS & EBS Models

- Same performance as EEA and EEB Series
- Snap-in mounting
- Spade terminals

## EAH & EBH Models

- Same size as EEA and EEB
- Minimal leakage current suitable for medical applications
- Flange mounted
- Spade terminals

## Specifications

**Maximum leakage current each Line to Ground:**

|                  | <u>EEA/EEB</u> | <u>EAS/EBS</u> | <u>EAH/EBH</u> |
|------------------|----------------|----------------|----------------|
| @ 120 VAC 60 Hz: | .22 mA         |                | 2 μA           |
| @ 250 VAC 50 Hz: | .38 mA         |                | 5 μA           |

**Hipot rating (one minute):**

|                 |          |
|-----------------|----------|
| Line to Ground: | 2250 VDC |
| Line to Line:   | 1450 VDC |

**Rated Voltage (max.):**

250 VAC

**Operating Frequency:**

50/60 Hz

**Rated Current:**

1 to 10A

**Operating Ambient Temperature Range**

**(at rated current  $I_r$ ):** -10°C to +40°C

In an ambient temperature ( $T_a$ ) higher than +40°C the maximum operating current ( $I_o$ ) is calculated as follows:  $I_o = I_r \sqrt{(85-T_a)/45}$

## Electrical Schematic

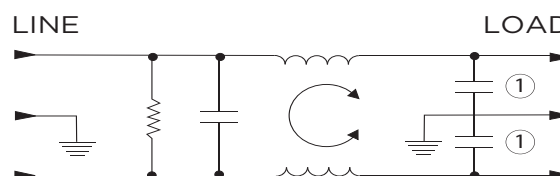

Note 1: Not present in EAH / EBH versions

**Cost-effective EMI Power Inlet Filter** *(continued)*

# EEA & EEB Series

## Ordering Information



## Available Part Numbers

| EEA Models | EEB Models |
|------------|------------|
| 1EEA1      | 1EEB1      |
| 1EEA2      | 1EEB2      |
| 1EEAP      | 1EEBP      |
| 3EEA1      | 3EEB1      |
| 3EEA2      | 3EEB2      |
| 3EEAP      | 3EEBP      |
| 6EEA1      | 6EEB1      |
| 6EEA2      | 6EEB2      |
| 6EEAP      | 6EEBP      |
| 10EEA1     | 10EEB1     |
| 10EEA2     | 10EEB2     |
| 10EEAP     | 10EEBP     |
| EAS Models | EBS Models |
| 1EAS1      | 1EBS1      |
| 3EAS1      | 3EBS1      |
| 6EAS1      | 6EBS1      |
| 10EAS1     | 10EBS1     |
| EAH Models | EBH Models |
| 1EAH1      | 1EBH1      |
| 3EAH1      | 3EBH1      |
| 6EAH1      | 6EBH1      |
| 10EAH1     | 10EBH1     |

## Accessories

**GA400:** NEMA 5-15P to IEC 60320-1 C-13 line cord



**FA601:** Insulating Shroud



Cost-effective EMI Power Inlet Filter (continued)

# EEA & EEB Series

## Case Styles

### EEA1, EEB1, EAH1 & EBH1



Typical Dimensions:  
 Mounting holes (2): .132 [3.35] Dia. with .236 [5.99] Dia. x 90° countersink for #4 flathead screw IEC 60320-1 C14  
 Line Inlet (1): IEC 60320-1 C14  
 Load Terminals (2): .250 [6.3] with .07 [1.8] Dia. hole  
 Ground Terminal (1): .250 [6.3] with .07 x .16 [1.8 x 3.8] slot

### EEA2 & EEB2

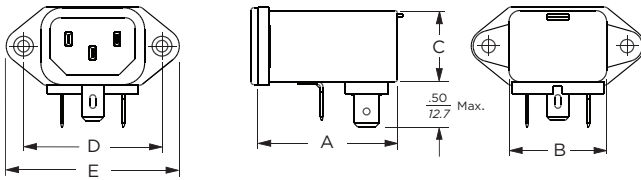

Typical Dimensions:  
 Mounting holes (2): .132 [3.35] Dia. with .236 [5.99] Dia. x 90° countersink for #4 flathead screw IEC 60320-1 C14  
 Line Inlet (1): IEC 60320-1 C14  
 Load Terminals (2): .250 [6.3] with .07 [1.8] Dia. hole  
 Ground Terminal (1): .250 [6.3] with .07 x .16 [1.8 x 3.8] slot

### EEAP & EEBP



Typical Dimensions:  
 Mounting holes (2): .132 [3.35] Dia. with .236 [5.99] Dia. x 90° countersink for #4 flathead screw IEC 60320-1 C14  
 Line Inlet (1): IEC 60320-1 C14  
 PC board pins (3): .031 [.07] square, ± .003 [.07]

### EAS1 & EBS1



Typical Dimensions:  
 Line Inlet (1): IEC 60320-1 C14  
 Load Terminals (2): .250 [6.3] with .07 [1.8] Dia. hole  
 Ground Terminal (1): .250 [6.3] with .07 x .16 [1.8 x 3.8] slot

## Case Dimensions

| Part No.               | A (max.) | B (max.) | C (max.) | D $\pm .010$ $\pm .25$ | E (max.) |
|------------------------|----------|----------|----------|------------------------|----------|
| EEA1, EEB1, EAH1, EBH1 | 2.15     | 1.12     | 0.81     | 1.575                  | 1.98     |
| EEA2, EEB2             | 39.1     | 28.4     | 20.6     | 40.01                  | 50.3     |
| EEAP, EEBP             | 39.1     | 28.4     | 20.6     | 40.01                  | 50.3     |
| EAS1, EBS1             | 55.88    | 29.2     | 24.38    | 30.10                  | 35.81    |

## Recommended Panel Cutouts

### EEA, EEB, EAH, EBH



Tolerances ± .005 [0.13] unless otherwise noted  
 Note 1: EEA1, EEB1, EAH1, EBH1 can be front or back mounted  
 Note 2: EEA2, EEB2, EEAP and EEBP can be back mounted only

### EAS, EBS



## PC Board Layout





Cost-effective EMI Power Inlet Filter *(continued)*

# EEA & EEB Series

## Performance Data

### Typical Insertion Loss

Measured in closed 50 Ohm system

— Common Mode / Asymmetrical (L-G)  
— Differential Mode / Symmetrical (L-L)

### EEA, EAS Models

#### 1A



#### 3A



#### 6A



#### 10A



### EEB, EBS Models

#### 1A



#### 3A



#### 6A



#### 10A



### EAH Models

#### 1A



#### 3A



#### 6A



#### 10A



### EBH Models

#### 1A



#### 3A



#### 6A



#### 10A



**Cost-effective EMI Power Inlet Filter** *(continued)*

# EEA & EEB Series

## Performance Data *(continued)*

### Minimum Insertion Loss

Measured in closed 50 Ohm system

Common Mode / Asymmetrical (Line to Ground)

| Current Rating          | Frequency – MHz |     |    |     |    |    |    |    |    |
|-------------------------|-----------------|-----|----|-----|----|----|----|----|----|
|                         | .01             | .05 | .1 | .15 | .5 | 1  | 5  | 10 | 30 |
| <b>EEA / EAS Models</b> |                 |     |    |     |    |    |    |    |    |
| 1A                      | 12              | 23  | 29 | 32  | 41 | 47 | 47 | 47 | 40 |
| 3A                      | -               | 10  | 15 | 19  | 30 | 36 | 48 | 50 | 47 |
| 6A                      | -               | 1   | 4  | 10  | 22 | 28 | 42 | 48 | 47 |
| 10A                     | -               | 1   | 3  | 5   | 14 | 20 | 32 | 38 | 47 |

**EEB / EBS Models**

|     |    |    |    |    |    |    |    |    |    |
|-----|----|----|----|----|----|----|----|----|----|
| 1A  | 12 | 23 | 29 | 32 | 41 | 47 | 47 | 47 | 40 |
| 3A  | -  | 10 | 14 | 18 | 30 | 36 | 48 | 50 | 47 |
| 6A  | -  | 1  | 4  | 10 | 22 | 28 | 42 | 48 | 47 |
| 10A | -  | 1  | 3  | 5  | 14 | 20 | 32 | 38 | 47 |

**EAH Models**

|     |   |    |    |    |    |    |    |    |    |
|-----|---|----|----|----|----|----|----|----|----|
| 1A  | 8 | 21 | 29 | 32 | 42 | 45 | 32 | 30 | 19 |
| 3A  | - | 5  | 10 | 15 | 25 | 27 | 30 | 27 | 22 |
| 6A  | - | -  | 5  | 6  | 19 | 21 | 24 | 20 | 15 |
| 10A | - | -  | 1  | 5  | 9  | 12 | 12 | 12 | 12 |

**EBH Models**

|     |   |    |    |    |    |    |    |    |    |
|-----|---|----|----|----|----|----|----|----|----|
| 1A  | 8 | 21 | 29 | 32 | 42 | 45 | 32 | 25 | 19 |
| 3A  | - | 5  | 10 | 15 | 25 | 27 | 30 | 27 | 22 |
| 6A  | - | -  | 5  | 8  | 17 | 20 | 24 | 23 | 18 |
| 10A | - | -  | -  | 3  | 8  | 12 | 12 | 12 | 12 |

Differential Mode / Symmetrical (Line to Line)

| Current Rating          | Frequency – MHz |   |     |    |    |    |    |  |
|-------------------------|-----------------|---|-----|----|----|----|----|--|
|                         | .5              | 1 | 1.5 | 3  | 5  | 10 | 30 |  |
| <b>EEA / EAS Models</b> |                 |   |     |    |    |    |    |  |
| 1A                      | 1               | 9 | 19  | 32 | 42 | 45 | 40 |  |
| 3A                      | 2               | 4 | 6   | 20 | 35 | 45 | 40 |  |
| 6A                      | 2               | 4 | 6   | 6  | 24 | 40 | 40 |  |
| 10A                     | 1               | 4 | 5   | 5  | 5  | 30 | 40 |  |

**EEB / EBS Models**

| Current Rating | Frequency – MHz |     |    |    |    |    |    |    |
|----------------|-----------------|-----|----|----|----|----|----|----|
|                | .01             | .15 | .5 | 1  | 3  | 5  | 10 | 30 |
| 1A             | 1               | 3   | 14 | 23 | 41 | 47 | 50 | 44 |
| 3A             | 1               | 2   | 11 | 14 | 25 | 38 | 44 | 40 |
| 6A             | 1               | 2   | 10 | 14 | 20 | 33 | 42 | 40 |
| 10A            | 1               | 2   | 10 | 16 | 19 | 19 | 39 | 40 |

**EAH Models**

| Current Rating | Frequency – MHz |     |    |    |    |
|----------------|-----------------|-----|----|----|----|
|                | 1               | 1.5 | 5  | 10 | 30 |
| 1A             | 5               | 13  | 28 | 32 | 25 |
| 3A             | 4               | 6   | 20 | 27 | 28 |
| 6A             | 2               | 5   | 19 | 25 | 27 |
| 10A            | 1               | 5   | 15 | 22 | 27 |

**EBH Models**

| Current Rating | Frequency – MHz |    |    |    |    |
|----------------|-----------------|----|----|----|----|
|                | .15             | .5 | 1  | 10 | 30 |
| 1A             | 1               | 10 | 18 | 30 | 31 |
| 3A             | 1               | 10 | 18 | 30 | 31 |
| 6A             | 1               | 10 | 18 | 30 | 31 |
| 10A            | 1               | 10 | 18 | 30 | 31 |

**Cost-effective Medium Performance Power Inlet Filter**

# EEJ Series

Including the EJH/EJHS, EJM/EJMS and EJS Models



**UL Recognized  
CSA Certified  
VDE Approved\***



## EEJ Series

- Compact EMI filter with IEC 60320-1 C14 Inlet
- Enhanced two element circuit provides medium attenuation to 30MHz
- Compact and cost-effective design
- Supersedes most ED Series versions
- Includes 20A version with standard IEC 60320-1 C20 inlet
- Several termination styles
- Flanged mounting

## EJS Models

- Same performance as the EEJ Series
- Snap-in mounting
- Several termination styles
- Includes 20A version with standard IEC 60320-1 C20 inlet

## EJH & EJHS Models

- Minimal leakage current suitable for patient-contact medical applications
- Flanged mounting the same as the EEJ Series
- Also available in snap-in versions (EJHS)
- Two element circuit provides modest EMI attenuation above 1MHz
- Capacitive input (refer to the H Series for capacitive output)
- EJHS models feature snap-in mounting

## EJM & EJMS Models

- Low leakage current, suitable for most medical applications
- Improved EMI attenuation up to 200MHz
- Mechanically the same as the EEJ Series with flange or snap-in mounting
- EJMS models feature snap-in mounting

## Specifications

**Maximum leakage current each Line to Ground:**

|                  | <u>EEJ/EJS</u> | <u>EJH</u> | <u>EJM</u> |
|------------------|----------------|------------|------------|
| @ 120 VAC 60 Hz: | .22 mA         | 2 µA       | .01 mA     |
| @250 VAC 50 Hz:  | .38 mA         | 5 µA       | .017 mA    |

**Hipot rating (one minute):**

|                 |          |
|-----------------|----------|
| Line to Ground: | 2250 VDC |
| Line to Line:   | 1450 VDC |

**Rated Voltage (max.):**

250 VAC

**Operating Frequency:**

50/60 Hz

**Rated Current:**

1 to 20A\*

**Operating Ambient Temperature Range**

**(at rated current  $I_r$ ):** -10°C to +40°C  
In an ambient temperature ( $T_a$ ) higher than +40°C the maximum operating current ( $I_o$ ) is calculated as follows:  $I_o = I_r \sqrt{(85-T_a)/45}$

## Electrical Schematic



Note 1: Not present in EJH versions

*\*15A versions are tested by Underwriters Laboratories to US and Canadian requirements and are VDE approved at 10A, 250VAC*

*20A versions are tested by Underwriters Laboratories to US and Canadian requirements and are VDE approved at 16A, 250VAC*

**Cost-effective Medium Performance Power Inlet Filter** *(continued)*

# EEJ Series

Including the EJH/EJHS, EJM/EJMS and EJS Models

## Ordering Information



## Accessories

**GA400:** NEMA 5-15P to IEC 60320-1 C-13 line cord



**FA601:** Insulating Shroud



## Available Part Numbers

| EEJ Models | EJH Models  |
|------------|-------------|
| 1EEJ1      | 1EJH1       |
| 1EEJ2      | 1EJH2       |
| 1EEJP      | 1EJHP       |
| 1EEJ8      | 1EJH8       |
| 3EEJ1      | 3EJH1       |
| 3EEJ2      | 3EJH2       |
| 3EEJP      | 3EJHP       |
| 3EEJ8      | 3EJH8       |
| 6EEJ1      | 6EJH1       |
| 6EEJ2      | 6EJH2       |
| 6EEJP      | 6EJHP       |
| 6EEJ8      | 6EJH8       |
| 10EEJ1     | 10EJH1      |
| 10EEJ2     | 10EJH2      |
| 10EEJP     | 10EJHP      |
| 10EEJ8     | 10EJH8      |
| 15EEJ1     | 15EJH1      |
| 15EEJ2     | 15EJH2      |
| 15EEJP     | 15EJHP      |
| 15EEJ8     | 15EJH8      |
| 20EEJ1     | 20EJH1      |
| 20EEJ8     | 20EJH8      |
| EJS Models | EJHS Models |
| 1EJS1      | 1EJHS1      |
| 1EJS8      | 1EJHS8      |
| 3EJS1      | 3EJHS1      |
| 3EJS8      | 3EJHS8      |
| 6EJS1      | 6EJHS1      |
| 6EJS8      | 6EJHS8      |
| 10EJS1     | 10EJHS1     |
| 10EJS8     | 10EJHS8     |
| 15EJS1     | 15EJHS1     |
| 15EJS8     | 15EJHS8     |
| 20EJS1     |             |
| 20EJS8     |             |
| EJM Models | EJMS Models |
| 1EJM1      | 1EJMS1      |
| 1EJM8      | 1EJMS8      |
| 3EJM1      | 3EJMS1      |
| 3EJM8      | 3EJMS8      |
| 6EJM1      | 6EJMS1      |
| 6EJM8      | 6EJMS8      |
| 10EJM1     | 10EJMS1     |
| 10EJM8     | 10EJMS8     |
| 15EJM1     | 15EJMS1     |
| 15EJM8     | 15EJMS8     |

**Cost-effective Medium Performance Power Inlet Filter** *(continued)*

# EEJ Series

 Including the EJH/EJHS, EJM/EJMS and EJS Models

## Case Styles

### EEJ1, EJH1 & EJM1 (1-15A)



Typical Dimensions:  
 Mounting holes (2): .132 [3.35] Dia. with .236 [5.99] Dia. x 90° countersink for #4 flathead screw  
 Line Inlet (1): IEC 60320-1 C14  
 Load Terminals (2): .250 [6.3] with .07 [1.8] Dia. hole  
 Ground Terminal (1): .250 [6.3] with .07 x .16 [1.8 x 3.8] slot

### EEJ2 & EJH2 (1-15A)



Typical Dimensions:  
 Mounting holes (2): .132 [3.35] Dia. with .236 [5.99] Dia. x 90° countersink for #4 flathead screw  
 Line Inlet (1): IEC 60320-1 C14  
 Load Terminals (2): .250 [6.3] with .07 [1.8] Dia. hole  
 Ground Terminal (1): .250 [6.3] with .07 x .16 [1.8 x 3.8] slot

### EEJP & EJHP (1-15A)



Typical Dimensions:  
 Mounting holes (2): .132 [3.35] Dia. with .236 [5.99] Dia. x 90° countersink for #4 flathead screw  
 Line Inlet (1): IEC 60320-1 C14  
 PC board pins (3): .031 [.07] square, ± .003 [.07]

### EJS1, EJHS1 & EJMS1 (1-15A)



Typical Dimensions:  
 Line Inlet (1): IEC 60320-1 C14  
 Load Terminals (2): .250 [6.3] with .07 [1.8] Dia. hole  
 Ground Terminal (1): .250 [6.3] with .07 x .16 [1.8 x 3.8] slot

### EEJ8, EJH8 & EJM8 (1-15A)



Typical Dimensions:  
 Mounting holes (2): .132 [3.35] Dia. with .236 [5.99] Dia. x 90° countersink for #4 flathead screw  
 Line Inlet (1): IEC 60320-1 C14  
 Wire Leads: 4.0 [101.6] Min., 18AWG, UL1015

### EJS8, EJHS8 & EJMS8 (1-15A)



Typical Dimensions:  
 Line Inlet (1): IEC 60320-1 C14  
 Wire Leads: 4.0 [101.6] Min., 18AWG, UL1015

### 20EEJ1 & 20EJH1



Typical Dimensions:  
 Mounting holes (2): .132 [3.35] Dia. with .236 [5.99] Dia. x 90° countersink for #4 flathead screw  
 Line Inlet (1): IEC 60320-1 C20  
 Load Terminals (2): .250 [6.3] with .07 [1.8] Dia. hole  
 Ground Terminal (1): .250 [6.3] with .07 x .16 [1.8 x 3.8] slot

**Cost-effective Medium Performance Power Inlet Filter** *(continued)*

# EEJ Series

Including the EJH/EJHS, EJM/EJMS and EJS Models

## Case Styles *(continued)*

### 20EJS1



Typical Dimensions:

- Line Inlet (1): IEC 60320-1 C20
- Load Terminals (2): .250 [6.3] with .07 [1.8] Dia. hole
- Ground Terminal (1): .250 [6.3] with .07 x .16 [1.8 x 3.8] slot

### 20EEJ8 & 20EJH8



Typical Dimensions:

- Mounting holes (2): .132 [3.35] Dia. with .236 [5.99] Dia. x 90° countersink for #4 flathead screw
- Line Inlet (1): IEC 60320-1 C20
- Wire Leads: 4.0 [101.6] Min., 14AWG, UL1015

### 20EJS8



Typical Dimensions:

- Line Inlet (1): IEC 60320-1 C20
- Wire Leads: 4.0 [101.6] Min., 14AWG, UL1015

## Recommended Panel Cutouts

### 1 to 15A EEJ, EJH & EJM



Tolerances ± .005 [0.13] unless otherwise noted

- Note 1: EEJ/EJH/EJM1 and EEJ/EJH/EJM8 can be front or back mounted
- Note 2: EEJ/EJH2 and EEJ/EJH8 can be back mounted only

### 20A EEJ & EJH



Tolerances ± .005 [0.13] unless otherwise noted

- Note 1: 20EEJ/EJH1 and 20EEJ/EJH8 can be front or back mounted

### 1 to 15A EJHS, EJMS & EJS



Tolerance ± .002 [0.050]

Alternate snap configurations to fit other cut-out sizes also available.  
Contact TE's Corcom product engineering group for more details.

### 20A EJS



Tolerance ± .002 [0.050]

## PC Board Layout



**Cost-effective Medium Performance Power Inlet Filter** *(continued)*

# EEJ Series

Including the EJH/EJHS, EJM/EJMS and EJS Models

## Case Dimensions

| Part No.       | A<br>(max.)                 | B<br>(max.)                 | C<br>(max.)                 | D<br>$\pm 0.15$<br>$\pm .38$ | E<br>(max.)                 | F<br>(ref.)                |
|----------------|-----------------------------|-----------------------------|-----------------------------|------------------------------|-----------------------------|----------------------------|
| EEJ1, EJH1     | <b>2.15</b><br><i>54.61</i> | <b>1.13</b><br><i>28.70</i> | <b>0.96</b><br><i>24.38</i> | <b>1.580</b><br><i>40.00</i> | <b>2.04</b><br><i>51.76</i> | -                          |
| EJM1           | <b>2.02</b><br><i>51.3</i>  | <b>1.13</b><br><i>28.7</i>  | <b>0.96</b><br><i>24.4</i>  | <b>1.58</b><br><i>40.00</i>  | <b>2.04</b><br><i>51.8</i>  | -                          |
| 1-10A          | <b>1.54</b>                 | <b>1.13</b>                 | <b>0.96</b>                 | <b>1.580</b>                 | <b>2.04</b>                 | -                          |
| EEJ2, EJH2     | <b>39.12</b>                | <b>28.70</b>                | <b>24.38</b>                | <b>40.00</b>                 | <b>51.76</b>                | -                          |
| 15A            | <b>1.79</b>                 | <b>1.13</b>                 | <b>0.96</b>                 | <b>1.580</b>                 | <b>2.04</b>                 | -                          |
| EEJ2, EJH2     | <b>45.47</b>                | <b>28.70</b>                | <b>24.38</b>                | <b>40.00</b>                 | <b>51.76</b>                | -                          |
| 1-10A          | <b>1.54</b>                 | <b>1.13</b>                 | <b>0.96</b>                 | <b>1.580</b>                 | <b>2.04</b>                 | -                          |
| EEJP, EJHP     | <b>39.12</b>                | <b>28.70</b>                | <b>24.38</b>                | <b>40.00</b>                 | <b>51.76</b>                | -                          |
| 15A            | <b>1.79</b>                 | <b>1.13</b>                 | <b>0.96</b>                 | <b>1.580</b>                 | <b>2.04</b>                 | -                          |
| EEJP, EJHP     | <b>45.47</b>                | <b>28.70</b>                | <b>24.38</b>                | <b>40.00</b>                 | <b>51.76</b>                | -                          |
| EJS1, EJHS1    | <b>2.20</b><br><i>55.88</i> | <b>1.13</b><br><i>28.70</i> | <b>0.96</b><br><i>24.38</i> | <b>1.19</b><br><i>30.10</i>  | <b>1.41</b><br><i>35.81</i> | -                          |
| EJMS1          | <b>2.02</b><br><i>51.3</i>  | <b>1.13</b><br><i>28.7</i>  | <b>0.96</b><br><i>24.4</i>  | -                            | <b>1.41</b><br><i>35.8</i>  | -                          |
| EEJ8, EJH8     | <b>1.54</b><br><i>39.12</i> | <b>1.13</b><br><i>28.70</i> | <b>0.81</b><br><i>20.70</i> | <b>1.58</b><br><i>40.00</i>  | <b>2.04</b><br><i>51.76</i> | -                          |
| EJM8           | <b>1.50</b><br><i>38.1</i>  | <b>1.13</b><br><i>28.7</i>  | <b>0.81</b><br><i>20.7</i>  | <b>1.58</b><br><i>40.00</i>  | <b>2.04</b><br><i>51.8</i>  | -                          |
| EJS8, EJHS8    | <b>1.54</b><br><i>39.12</i> | <b>1.13</b><br><i>28.70</i> | <b>0.81</b><br><i>20.70</i> | <b>1.19</b><br><i>30.10</i>  | <b>1.41</b><br><i>35.81</i> | -                          |
| EJMS8          | <b>1.50</b><br><i>38.1</i>  | <b>1.13</b><br><i>28.7</i>  | <b>0.96</b><br><i>24.4</i>  | -                            | <b>1.41</b><br><i>35.8</i>  | -                          |
| 20EEJ1, 20EJH1 | <b>3.13</b><br><i>79.38</i> | <b>1.37</b><br><i>34.79</i> | <b>1.18</b><br><i>29.99</i> | <b>1.65</b><br><i>42.01</i>  | <b>2.09</b><br><i>53.00</i> | -                          |
| 20EJS1         | <b>3.13</b><br><i>79.38</i> | <b>1.35</b><br><i>34.29</i> | <b>1.18</b><br><i>29.99</i> | <b>1.42</b><br><i>36.07</i>  | <b>1.46</b><br><i>37.08</i> | -                          |
| 20EEJ8, 20EJH8 | <b>2.65</b><br><i>67.31</i> | <b>1.35</b><br><i>34.29</i> | <b>1.18</b><br><i>29.99</i> | <b>1.65</b><br><i>42.01</i>  | <b>2.09</b><br><i>53.00</i> | <b>.62</b><br><i>15.75</i> |
| 20EJS8         | <b>2.63</b><br><i>66.80</i> | <b>1.35</b><br><i>34.29</i> | <b>1.18</b><br><i>29.97</i> | <b>1.46</b><br><i>37.08</i>  | <b>1.42</b><br><i>36.08</i> | <b>.62</b><br><i>15.75</i> |



## Performance Data

### Typical Insertion Loss

Measured in closed 50 Ohm system

### EEJ & EJS Models

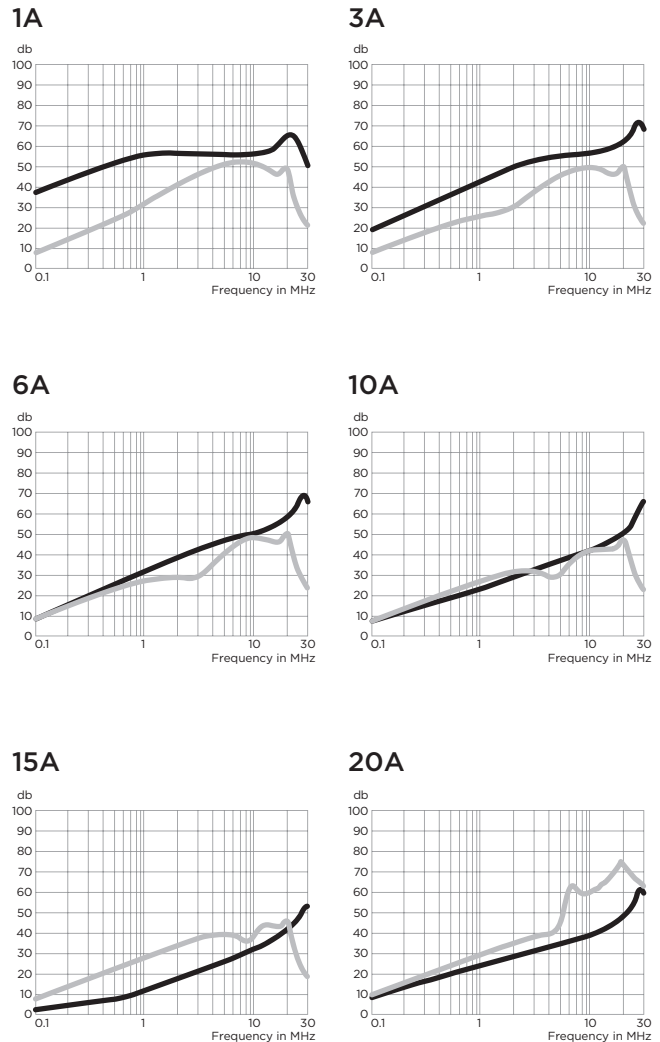

3
 Power Inlet Filters & Power Entry Modules

**Cost-effective Medium Performance Power Inlet Filter** *(continued)*

# EEJ Series

Including the EJH/EJHS, EJM/EJMS and EJS Models

## Performance Data *(continued)*

### Typical Insertion Loss

Measured in closed 50 Ohm system

#### EJH & EJHS Models

**1A**



**3A**



**6A**



**10A**



**15A**



**20A**



#### EJM & EJMS Models

**1A**



**3A**



**6A**



**10A**



**15A**



— Common Mode / Asymmetrical (L-G)  
— Differential Mode / Symmetrical (L-L)



**Cost-effective Medium Performance Power Inlet Filter** *(continued)*

# EEJ Series

Including the EJH/EJHS, EJM/EJMS and EJS Models

## Minimum Insertion Loss

Measured in closed 50 Ohm system

Common Mode / Asymmetrical (Line to Ground)

| Current Rating          | Frequency – MHz |     |    |     |    |    |    |    |    |
|-------------------------|-----------------|-----|----|-----|----|----|----|----|----|
|                         | .01             | .05 | .1 | .15 | .5 | 1  | 5  | 10 | 30 |
| <b>EEJ / EJS Models</b> |                 |     |    |     |    |    |    |    |    |
| 1A                      | 15              | 27  | 29 | 32  | 41 | 47 | 47 | 47 | 40 |
| 3A                      | -               | 10  | 15 | 20  | 30 | 39 | 48 | 50 | 60 |
| 6A                      | -               | 1   | 5  | 9   | 21 | 28 | 41 | 44 | 54 |
| 10A                     | -               | 1   | 4  | 7   | 14 | 18 | 31 | 36 | 51 |
| 15A                     | -               | -   | -  | 2   | 5  | 8  | 21 | 26 | 42 |
| 20A                     | -               | -   | 3  | 5   | 14 | 21 | 30 | 33 | 42 |
| <b>EJH Models</b>       |                 |     |    |     |    |    |    |    |    |
| 1A                      | 13              | 26  | 33 | 36  | 41 | 41 | 31 | 26 | 18 |
| 3A                      | -               | 9   | 15 | 19  | 27 | 31 | 30 | 26 | 20 |
| 6A                      | -               | 2   | 6  | 9   | 20 | 22 | 31 | 20 | 18 |
| 10A                     | -               | 1   | 4  | 7   | 12 | 17 | 19 | 18 | 18 |
| 15A                     | -               | -   | 1  | 2   | 3  | 3  | 4  | 2  | 2  |
| 20A                     | -               | -   | 3  | 5   | 14 | 16 | 12 | 11 | 11 |

Differential Mode / Symmetrical (Line to Line)

| Current Rating          | Frequency – MHz |     |    |     |    |    |    |    |    |     |     |
|-------------------------|-----------------|-----|----|-----|----|----|----|----|----|-----|-----|
|                         | .01             | .05 | .1 | .15 | .5 | 1  | 5  | 10 | 30 | EEJ | EJS |
| <b>EEJ / EJS Models</b> |                 |     |    |     |    |    |    |    |    |     |     |
| 1A                      | -               | -   | 5  | 8   | 19 | 27 | 45 | 43 | 40 | 9   |     |
| 3A                      | -               | -   | 5  | 8   | 17 | 20 | 39 | 42 | 40 | 11  |     |
| 6A                      | -               | -   | 5  | 8   | 17 | 21 | 32 | 40 | 40 | 16  |     |
| 10A                     | -               | -   | 5  | 8   | 17 | 21 | 23 | 36 | 38 | 16  |     |
| 15A                     | -               | -   | 5  | 8   | 17 | 23 | 33 | 30 | 38 | 11  |     |
| 20A                     | -               | -   | 5  | 2   | 17 | 25 | 38 | 48 | 48 | 48  |     |
| <b>EJH Models</b>       |                 |     |    |     |    |    |    |    |    |     |     |
| 1A                      | 13              | 26  | 33 | 36  | 41 | 41 | 31 | 26 | 18 |     |     |
| 3A                      | -               | 9   | 15 | 19  | 27 | 31 | 30 | 26 | 20 |     |     |
| 6A                      | -               | 2   | 6  | 9   | 20 | 22 | 31 | 20 | 18 |     |     |
| 10A                     | -               | 1   | 4  | 7   | 12 | 17 | 19 | 18 | 18 |     |     |
| 15A                     | -               | -   | 1  | 2   | 3  | 3  | 4  | 2  | 2  |     |     |
| 20A                     | -               | -   | 3  | 5   | 14 | 16 | 12 | 11 | 11 |     |     |

## EJM & EJMS Models

| Current Rating | Frequency – MHz |    |    |    |    |    |    |     |     |
|----------------|-----------------|----|----|----|----|----|----|-----|-----|
|                | .05             | .5 | 1  | 10 | 20 | 30 | 80 | 150 | 200 |
| 1A             | 25              | 41 | 37 | 18 | 15 | 13 | 15 | 14  | 7   |
| 3A             | 6               | 27 | 30 | 21 | 19 | 19 | 23 | 13  | 7   |
| 6A             | 2               | 17 | 20 | 17 | 17 | 14 | 23 | 13  | 7   |
| 10A            | 1.5             | 11 | 12 | 9  | 8  | 9  | 20 | 19  | 12  |
| 15A            | 0.5             | 2  | 3  | 4  | 2  | 10 | 12 | 17  | 11  |

| Current Rating | Frequency – MHz |    |    |    |    |    |    |     |     |
|----------------|-----------------|----|----|----|----|----|----|-----|-----|
|                | .05             | .5 | 1  | 10 | 20 | 30 | 80 | 150 | 200 |
| 1A             | 1.5             | 21 | 28 | 34 | 36 | 29 | 27 | 34  | 28  |
| 3A             | 1.5             | 17 | 23 | 29 | 31 | 37 | 33 | 32  | 28  |
| 6A             | 1.5             | 16 | 22 | 28 | 29 | 34 | 37 | 37  | 32  |
| 10A            | 2               | 16 | 22 | 28 | 24 | 18 | 27 | 32  | 30  |
| 15A            | 1.5             | 17 | 23 | 35 | 34 | 29 | 27 | 29  | 25  |



EMI Power Inlet Filter

# EF Series



UL Recognized  
CSA Certified  
VDE Approved\*



## EF Series

- Compact single stage EMI filter with IEC 60320-1 C14 inlet
- Two element circuit provides basic attenuation
- Available with an internal ground-circuit inductor (C suffix versions) to isolate equipment chassis from power line ground at radio frequencies
- Superseded by the EEA Series

## Ordering Information



## Available Part Numbers

|                                  |       |      |      |
|----------------------------------|-------|------|------|
| 1EF1F                            | 1EF2F | 1EF4 | 1EF8 |
| 3EF1F                            | 3EF2F | 3EF4 | 3EF8 |
| 6EF1F                            | 6EF2F | 6EF4 | 6EF8 |
| 10EF1F                           |       |      |      |
| 15EF1F                           |       |      |      |
| Ground Circuit Inductor Versions |       |      |      |
| 10EF1FC                          |       |      |      |

## Specifications

- Maximum leakage current each Line to Ground:**
- @ 120 VAC 60 Hz: .21 mA
  - @ 250 VAC 50 Hz: .36 mA
- Hipot rating (one minute):**
- Line to Ground: 2250 VDC
  - Line to Line: 1450 VDC
- Rated Voltage (max.):** 250 VAC
- Operating Frequency:** 50/60 Hz
- Rated Current:** 1 to 15A\*
- Operating Ambient Temperature Range (at rated current I<sub>r</sub>):** -10°C to +40°C
- In an ambient temperature (T<sub>a</sub>) higher than +40°C the maximum operating current (I<sub>O</sub>) is calculated as follows:  $I_O = I_r \sqrt{(85-T_a)/45}$

## Accessories

**GA400:** NEMA 5-15P to IEC 60320-1 C-13 line cord



**FA601:** Insulating Shroud



\*15A versions are tested by Underwriters Laboratories to US and Canadian requirements and are VDE approved at 10A, 250VAC

EMI Power Inlet Filter (continued)

# EF Series

## Electrical Schematic



Note 1: C Suffix (ground choke) versions only

## Case Styles

### EF1F & EF1FC



Typical Dimensions:

Line Inlet (1): IEC 60320-1 C14  
Load Terminals (2): .250 [6.3] with .07 [1.8] Dia. hole  
Ground Terminal (1): .250 [6.3] with .07 x .16 [1.8 x 3.8] slot

### EF2F



Typical Dimensions:

Line Inlet (1): IEC 60320-1 C14  
Load Terminals (2): .250 [6.3] with .07 [1.8] Dia. hole  
Ground Terminal (1): .250 [6.3] with .07 x .16 [1.8 x 3.8] slot

### EF4



Typical Dimensions:

Line Inlet (1): IEC 60320-1 C14  
Wire Leads: 4.0 [101.6] Min., 18AWG, UL1015

### EF8



Typical Dimensions:

Line Inlet (1): IEC 60320-1 C14  
Wire Leads: 4.0 [101.6] Min., 18AWG, UL1015

## Case Dimensions

| Part No.            | A<br>(max.) | B<br>(max.) | C<br>(max.) | D<br>$\pm .015$<br>$\pm .38$ | E<br>(max.) | F<br>(ref.) |
|---------------------|-------------|-------------|-------------|------------------------------|-------------|-------------|
| 1EF1F, 3EF1F, 6EF1F | 2.21        | 1.19        | 0.81        | 1.575                        | 1.98        | -           |
| 1EF2F, 3EF2F, 6EF2F | 1.55        | 1.19        | 0.85        | 1.575                        | 1.98        | -           |
| 1EF4, 3EF4, 6EF4    | 1.55        | 1.19        | 0.85        | 1.575                        | 1.98        | .295        |
| 1EF8, 3EF8, 6EF8    | 1.55        | 1.19        | 0.81        | 1.575                        | 1.98        | .295        |
| 10EF1F, 10EF1FC     | 2.62        | 1.19        | 0.81        | 1.575                        | 1.98        | -           |
| 15EF1F              | 2.62        | 1.19        | 0.81        | 1.575                        | 1.98        | -           |

## Recommended Panel Cutouts



Tolerances  $\pm .005$  [0.13] unless otherwise noted

Note 1: EF1F, EF1FC and EF8 allow for front or back mounting  
Note 2: EF2F and EF4 allow for back mounting only

**EMI Power Inlet Filter** *(continued)*

# EF Series

## Performance Data

### Typical Insertion Loss

Measured in closed 50 Ohm system

**1EF**

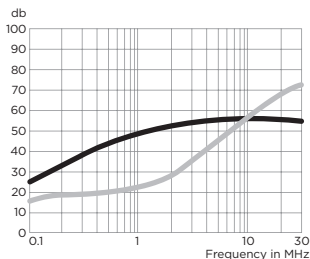

**3EF**

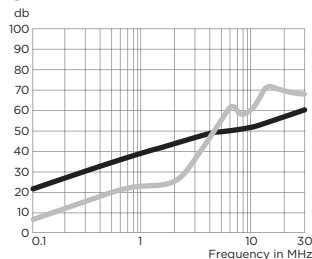

**6EF**

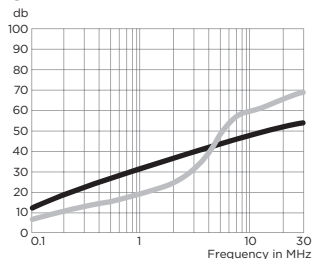

**10EF**

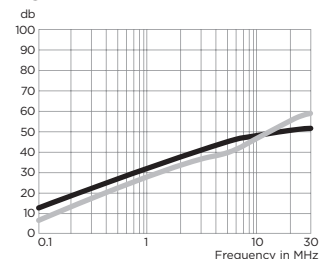

**15EF**

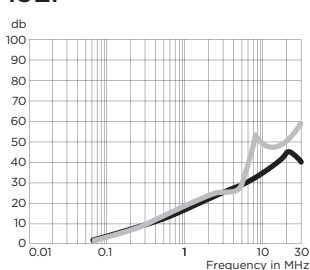

— Common Mode / Asymmetrical (L-G)  
— Differential Mode / Symmetrical (L-L)

### Minimum Insertion Loss

Measured in closed 50 Ohm system

Common Mode / Asymmetrical (Line to Ground)

| Current Rating    | Frequency – MHz |    |    |    |    |    |
|-------------------|-----------------|----|----|----|----|----|
|                   | .15             | .5 | 1  | 5  | 10 | 30 |
| <b>EF1F, EF2F</b> |                 |    |    |    |    |    |
| 1A                | 22              | 35 | 40 | 46 | 50 | 49 |
| 3A                | 15              | 25 | 30 | 45 | 50 | 54 |
| 6A                | 9               | 20 | 25 | 41 | 45 | 50 |
| 10A               | 8               | 15 | 20 | 34 | 39 | 44 |
| 15A               | -               | 6  | 12 | 20 | 25 | 25 |
| <b>EF4, EF8</b>   |                 |    |    |    |    |    |
| 1A                | 22              | 35 | 40 | 46 | 50 | 49 |
| 3A                | 15              | 25 | 30 | 45 | 50 | 54 |
| 6A                | 9               | 20 | 25 | 41 | 45 | 47 |
| <b>EF1FC</b>      |                 |    |    |    |    |    |
| 10A               | 8               | 15 | 20 | 34 | 39 | 44 |

High Performance Power Inlet Filter

# EJT Series



UL Recognized  
CSA Certified  
VDE Approved\*



## EJT Series

- Superior EMI filter with IEC 60320-1 inlet
- Double three element differential mode circuit attenuates noise up to 1GHz
- Up to 15A with IEC 60320-1 C14 inlet
- 20A rating with IEC 60320-1 C20 inlet
- Spade terminals or wire leads

## Ordering Information



## Available Part Numbers

|        |        |
|--------|--------|
| 1EJT1  | 1EJT8  |
| 3EJT1  | 3EJT8  |
| 6EJT1  | 6EJT8  |
| 10EJT1 | 10EJT8 |
| 15EJT1 | 15EJT8 |
| 20EJT1 | 20EJT8 |

*\*15A versions are tested by Underwriters Laboratories to US and Canadian requirements and are VDE approved at 10A, 250VAC.  
20A versions are tested by Underwriters Laboratories to US and Canadian requirements and are VDE approved at 16A, 250VAC.*

## Specifications

### Maximum leakage current each Line to Ground:

|                  |              |            |
|------------------|--------------|------------|
|                  | <u>1-15A</u> | <u>20A</u> |
| @ 120 VAC 60 Hz: | .25 mA       | .22 mA     |
| @250 VAC 50 Hz:  | .43 mA       | .40 mA     |

### Hipot rating (one minute):

|                 |          |
|-----------------|----------|
| Line to Ground: | 2250 VDC |
| Line to Line:   | 1450 VDC |

**Rated Voltage (max.):** 250 VAC

**Operating Frequency:** 50/60 Hz

**Rated Current:** 1 to 20A\*

### Operating Ambient Temperature Range

(at rated current  $I_r$ ): -10°C to +40°C  
In an ambient temperature ( $T_a$ ) higher than +40°C the maximum operating current ( $I_o$ ) is calculated as follows:  $I_o = I_r \sqrt{(85-T_a)/45}$

## Accessories

**GA400:** NEMA 5-15P to IEC 60320-1 C-13 line cord



**FA601:** Insulating Shroud (*fits 1-15A only*)

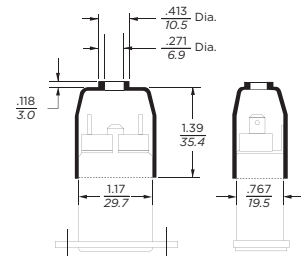

High Performance Power Inlet Filter *(continued)*

# EJT Series

## Electrical Schematics



Note 1: 20A versions only

## Case Styles

### EJT1



Typical Dimensions:  
 Mounting holes (2): .132 [3.35] Dia. with .236 [5.99] Dia. x 90° countersink for #4 flathead screw IEC 60320-1 C14  
 Line Inlet (1): IEC 60320-1 C20  
 Load Terminals (2): .250 [6.3] with .07 [1.8] Dia. hole  
 Ground Terminal (1): .250 [6.3] with .07 x .16 [1.8 x 3.8] slot

### 20EJT1



Typical Dimensions:  
 Mounting holes (2): .126 [3.20] Dia. with .236 [5.99] Dia. x 90° countersink for #4 flathead screw IEC 60320-1 C20  
 Line Inlet (1): IEC 60320-1 C20  
 Load Terminals (2): .250 [6.3] with .07 [1.8] Dia. hole  
 Ground Terminal (1): .250 [6.3] with .07 x .16 [1.8 x 3.8] slot

### EJT8



Typical Dimensions:  
 Mounting holes (2): .132 [3.35] Dia. with .236 [5.99] Dia. x 90° countersink for #4 flathead screw IEC 60320-1 C14  
 Line Inlet (1): IEC 60320-1 C14  
 Wire Leads: 4.0 [101.6] Min., 18AWG, UL1015

### 20EJT8



Typical Dimensions:  
 Mounting holes (2): .126 [3.20] Dia. with .236 [5.99] Dia. x 90° countersink for #4 flathead screw IEC 60320-1 C20  
 Line Inlet (1): IEC 60320-1 C20  
 Wire Leads: 4.0 [101.6] Min., 14AWG, UL1015

## Case Dimensions

| Part No. | A<br>(max.)  | B<br>(max.)    | C<br>(max.)   | D<br>(max.)    | E<br>(max.)    |
|----------|--------------|----------------|---------------|----------------|----------------|
| EJT1     | 2.74<br>69.6 | 1.19<br>30.2   | 0.875<br>22.2 | 1.575<br>40.0  | 1.98<br>50.3   |
| EJT8     | 2.1<br>53.3  | 1.19<br>30.2   | 0.875<br>22.2 | 1.575<br>40.0  | 1.98<br>50.3   |
| 20EJT1   | 3.8<br>96.52 | 1.350<br>34.29 | 1.18<br>29.99 | 1.654<br>42.01 | 2.087<br>53.00 |
| 20EJT8   | 3.2<br>81.28 | 1.350<br>34.29 | 1.18<br>29.99 | 1.654<br>42.01 | 2.087<br>53.00 |

## Recommended Panel Cutouts



High Performance Power Inlet Filter *(continued)*

# EJT Series

## Performance Data

### Typical Insertion Loss

Measured in closed 50 Ohm system

1EJT



3EJT



6EJT



10EJT

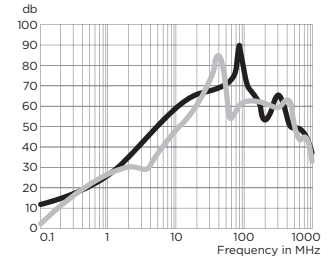

15EJT



20EJT



— Common Mode / Asymmetrical (L-G)  
- - - Differential Mode / Symmetrical (L-L)

### Minimum Insertion Loss

Measured in closed 50 Ohm system

Common Mode / Asymmetrical (Line to Ground)

| Current Rating | Frequency – MHz |    |    |    |    |    |     |      |
|----------------|-----------------|----|----|----|----|----|-----|------|
|                | .15             | .5 | 1  | 5  | 10 | 30 | 100 | 1000 |
| 1A             | 27              | 33 | 40 | 59 | 65 | 65 | 61  | 14   |
| 3A             | 22              | 30 | 34 | 57 | 63 | 69 | 61  | 10   |
| 6A             | 13              | 21 | 27 | 51 | 60 | 65 | 59  | 14   |
| 10A            | 7               | 14 | 21 | 43 | 52 | 61 | 61  | 14   |
| 15A            | 4               | 10 | 15 | 38 | 48 | 63 | 63  | 14   |
| 20A            | -               | 8  | 15 | 42 | 50 | 60 | 58  | 14   |

Differential Mode / Symmetrical (Line to Line)

| Current Rating | Frequency – MHz |    |    |    |    |    |     |      |
|----------------|-----------------|----|----|----|----|----|-----|------|
|                | .15             | .5 | 1  | 5  | 10 | 30 | 100 | 1000 |
| 1A             | 10              | 20 | 23 | 43 | 52 | 65 | 45  | 14   |
| 3A             | 10              | 20 | 24 | 41 | 51 | 59 | 52  | 17   |
| 6A             | 10              | 21 | 24 | 37 | 48 | 65 | 55  | 20   |
| 10A            | 10              | 21 | 25 | 28 | 44 | 63 | 53  | 18   |
| 15A            | 10              | 20 | 26 | 25 | 36 | 56 | 45  | 23   |
| 20A            | 9               | 20 | 26 | 40 | 35 | 48 | 50  | 10   |

**Smallest Power Entry Module with Metric Fuse Holders**

# GG & HG Series



UL Recognized  
CSA Certified  
VDE Approved



## GG Series

- Power entry module with enhanced EMI filter
- Single or dual fusing
- Two element circuit provides basic attenuation
- Available with an internal ground-circuit inductor (C versions) to isolate equipment chassis from power line ground at radio frequencies
- Multiple termination and mounting styles

## HG Series

- Medical version of our GG Series
- Mechanically identical to GG Series
- Available only with dual fusing

## Ordering Information



## Specifications

**Maximum leakage current each Line to Ground:**

|                  | <u>HG Models</u> | <u>GG Models</u> |
|------------------|------------------|------------------|
| @ 120 VAC 60 Hz: | 2 $\mu$ A        | .25 mA           |
| @250 VAC 50 Hz:  | 5 $\mu$ A        | .42 mA           |

**Hipot rating (one minute):**

|                 |          |
|-----------------|----------|
| Line to Ground: | 2250 VDC |
| Line to Line:   | 1450 VDC |

**Rated Voltage (max.):** 250 VAC

**Operating Frequency:** 50/60 Hz

**Rated Current:** 1 to 10A

**Required Fuse(s):** 5 x 20mm  
*(not included)*

## Available Part Numbers

| Filtered modules                              |          |          |           |
|---|----------|----------|-----------|
| 1EGG1-1                                       | 3EGG1-1  | 6EGG1-1  | 10EGG1-1  |
| 1EGG1-2                                       | 3EGG1-2  | 6EGG1-2  | 10EGG1-2  |
| 1EGG8-1                                       | 3EGG8-1  | 6EGG8-1  | 10EGG8-1  |
| 1EGG8-2                                       | 3EGG8-2  | 6EGG8-2  | 10EGG8-2  |
| 1EGS1-1                                       | 3EGS1-1  | 6EGS1-1  | 10EGS1-1  |
| 1EGS1-2                                       | 3EGS1-2  | 6EGS1-2  | 10EGS1-2  |
| Filtered modules with ground circuit inductor |          |          |           |
| 1EGG1C-1                                      | 3EGG1C-1 | 6EGG1C-1 |           |
| 1EGG1C-2                                      | 3EGG1C-2 | 6EGG1C-2 |           |
| 1EGG8C-1                                      | 3EGG8C-1 | 6EGG8C-1 |           |
| 1EGG8C-2                                      | 3EGG8C-2 | 6EGG8C-2 |           |
| Medical filter modules                        |          |          |           |
| 1EHG1-2                                       | 3EHG1-2  | 6EHG1-2  | 10EHG1-2  |
| 1EHG8-2                                       | 3EHG8-2  | 6EHG8-2  | 10EHG8-2  |
| 1EHGS1-2                                      | 3EHGS1-2 | 6EHGS1-2 | 10EHGS1-2 |



Smallest Power Entry Module with Metric Fuse Holders *(continued)*

# GG & HG Series

## Electrical Schematic



Note 1: Second fuse only in -2 version  
Note 2: C versions only  
Note 3: Not present in HG versions

Warning: Do not attempt to operate a single-fused model without the fuse door in place.

## Accessories

GA400: NEMA 5-15P to IEC 60320-1 C-13 line cord



## Case Styles

### GG1, GG1C & HG1



Typical Dimensions:  
Mounting holes (2): .132 [3.35] Dia. with .236 [5.99] Dia. x 90°  
countersink for #4 flathead screw  
Line Inlet (1): IEC 60320-1 C14  
Load Terminals (2): .250 [6.3] with .07 [1.8] Dia. hole  
Ground Terminal (1): .250 [6.3] with .07 x .16 [1.8 x 3.8] slot

### GS1 & HGS1



Typical Dimensions:  
Line Inlet (1): IEC 60320-1 C14  
Load Terminals (2): .250 [6.3] with .07 [1.8] Dia. hole  
Ground Terminal (1): .250 [6.3] with .07 x .16 [1.8 x 3.8] slot

## GG8 & HG8



Typical Dimensions:  
Mounting holes (2): .132 [3.35] Dia. with .236 [5.99] Dia. x 90°  
countersink for #4 flathead screw  
Line Inlet (1): IEC 60320-1 C14  
Wire Leads: 5.0 [127.0] Min., 18AWG, UL1015

## Case Dimensions

| Part No.  | A<br>(max.)                 | B<br>(max.)                | C<br>(max.)                | D<br>$\pm .015$<br>$\pm .38$ | E<br>(max.)                |
|-----------|-----------------------------|----------------------------|----------------------------|------------------------------|----------------------------|
| GG1 & HG1 | <b>2.13</b><br><i>54.5</i>  | <b>1.13</b><br><i>28.7</i> | <b>1.29</b><br><i>32.8</i> | <b>1.417</b><br><i>36.0</i>  | <b>1.76</b><br><i>44.7</i> |
| GG1C      | <b>2.45</b><br><i>62.23</i> | <b>1.13</b><br><i>28.7</i> | <b>1.28</b><br><i>32.5</i> | <b>1.417</b><br><i>36.0</i>  | <b>1.76</b><br><i>44.7</i> |
| GS1, HGS1 | <b>2.13</b><br><i>54.0</i>  | <b>1.13</b><br><i>28.7</i> | <b>1.28</b><br><i>32.5</i> | <b>1.46*</b><br><i>36.0*</i> | <b>1.42</b><br><i>36.1</i> |
| GG8, HG8  | <b>2.02</b><br><i>51.1</i>  | <b>1.13</b><br><i>28.7</i> | <b>1.29</b><br><i>32.8</i> | <b>1.417</b><br><i>36.0</i>  | <b>1.76</b><br><i>44.7</i> |

\*max. dimension

## Recommended Panel Cutouts

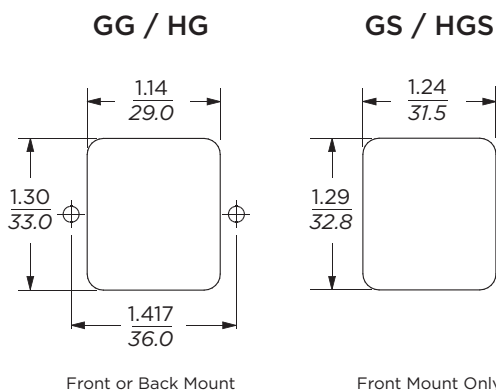

Typical Dimensions:  
GS / HGS panel thickness: 0.032 – 0.080 [0.81 – 2.03]  
Corner radius: 0.138 [0.35]

**Smallest Power Entry Module with Metric Fuse Holders** *(continued)*

# GG & HG Series

## Performance Data

**Typical Insertion Loss** Measured in closed 50 Ohm system

### GG & GS Models

#### 1A



#### 3A



#### 6A



#### 10A



#### 3A GGIC



#### 6A GGIC



— Common Mode / Asymmetrical (L-G)  
— Differential Mode / Symmetrical (L-L)

### HG Models

#### 1A



#### 3A



#### 6A



#### 10A



**Minimum Insertion Loss** Measured in closed 50 Ohm system

Common Mode / Asymmetrical (Line to Ground)

| Current Rating            | Frequency – MHz |     |     |     |    |    |    |    |    |
|---------------------------|-----------------|-----|-----|-----|----|----|----|----|----|
|                           | .01             | .05 | .10 | .15 | .5 | 1  | 5  | 10 | 30 |
| <b>GG &amp; GS Models</b> |                 |     |     |     |    |    |    |    |    |
| 1A                        | 12              | 23  | 29  | 32  | 41 | 47 | 50 | 50 | 55 |
| 3A                        | -               | 10  | 15  | 19  | 30 | 36 | 48 | 50 | 53 |
| 6A                        | -               | 1   | 4   | 10  | 16 | 22 | 36 | 40 | 50 |
| 10A                       | -               | 1   | 2   | 4   | 6  | 8  | 26 | 33 | 28 |
| <b>HG Models</b>          |                 |     |     |     |    |    |    |    |    |
| 1A                        | 12              | 23  | 29  | 32  | 40 | 40 | 28 | 22 | 18 |
| 3A                        | -               | 10  | 15  | 19  | 25 | 26 | 22 | 21 | 21 |
| 6A                        | -               | 4   | 10  | 14  | 18 | 18 | 14 | 14 | 14 |
| 10A                       | 1               | -   | -   | 3   | 5  | 6  | 8  | 9  | 10 |

Differential Mode / Symmetrical (Line to Line)

| Current Rating            | Frequency – MHz |     |    |    |    |    |    |    |
|---------------------------|-----------------|-----|----|----|----|----|----|----|
|                           | .10             | .15 | .5 | 1  | 3  | 5  | 10 | 30 |
| <b>GG &amp; GS Models</b> |                 |     |    |    |    |    |    |    |
| 1A                        | 1               | 3   | 14 | 23 | 41 | 47 | 50 | 44 |
| 3A                        | 1               | 2   | 11 | 14 | 25 | 38 | 44 | 40 |
| 6A                        | 1               | 2   | 10 | 13 | 23 | 33 | 39 | 42 |
| 10A                       | 4               | 7   | 17 | 23 | -  | 22 | 43 | 38 |
| <b>HG Models</b>          |                 |     |    |    |    |    |    |    |
| 1A                        | 2               | 6   | 19 | 26 | 30 | 35 | 35 | 20 |
| 3A                        | 1               | 7   | 16 | 23 | 30 | 30 | 30 | 30 |
| 6A                        | 4               | 7   | 16 | 23 | 30 | 30 | 30 | 30 |
| 10A                       | -               | 8   | 16 | 22 | -  | 37 | 43 | 28 |

**Power Inlet Line Filter for Medical Equipment**

# H Series



UL Recognized  
CSA Certified  
VDE Approved\*



## H Series

- Minimal leakage current suitable for medical equipment
- Two element circuit provides basic EMI attenuation above 1 MHz
- Available with an internal ground circuit inductor (C suffix versions) to isolate equipment chassis from power line ground at radio frequencies
- Flanged mounting the same as the EC, ED and EF Series
- Capacitive output (see EAH, EBH and EJH Series for capacitive input)

## Ordering Information



\*IEC 60320-1 C14 inlet mates with C13 connector

## Specifications

### Maximum leakage current each Line to Ground:

|                  |      |
|------------------|------|
| @ 120 VAC 60 Hz: | 2 µA |
| @ 250 VAC 50 Hz: | 5 µA |

### Hipot rating (one minute):

|                 |          |
|-----------------|----------|
| Line to Ground: | 2250 VDC |
| Line to Line:   | 1450 VDC |

### Rated Voltage (max.):

250 VAC

### Operating Frequency:

50/60 Hz

### Rated Current:

3 to 15A\*

### Operating Ambient Temperature Range

(at rated current  $I_r$ ): -10°C to +40°C

In an ambient temperature ( $T_a$ ) higher than +40°C the maximum operating current ( $I_o$ ) is calculated as follows:  $I_o = I_r \sqrt{(85-T_a)/45}$

## Electrical Schematic

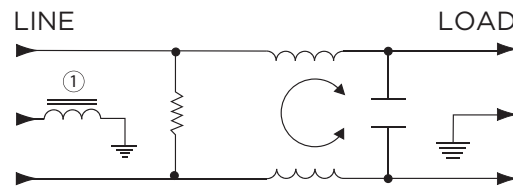

## Available Part Numbers

|                                  |       |
|----------------------------------|-------|
| 3EH1                             | 6EH8  |
| 3EH3                             | 6EH9  |
| 6EH1                             | 10EH1 |
| 6EH3                             | 10EH3 |
| 6EH4                             | 10EH4 |
| 6EH5                             | 15EH4 |
| Ground Circuit Inductor Versions |       |
| 10EH4C                           |       |

\*15A versions are tested by Underwriters Laboratories to US and Canadian requirements and are VDE approved at 10A, 250VAC

**Power Inlet Line Filter for Medical Equipment** *(continued)*

# H Series

## Case Styles

### H1 (Chassis Mount)



Typical Dimensions:  
 Mounting Holes: .188 [4.78] Dia.  
 Line / Load Terminals (4): .250 [6.3] with .07 [1.8] Dia. hole  
 Ground Terminal (1): .250 [6.3] with .07 x .16 [1.8 x 3.8] slot

### H3 (Chassis Mount)



Typical Dimensions:  
 Mounting Holes: .188 [4.78] Dia.  
 Wire Leads(5): 4.0 [101.6] Min., 18AWG, UL1015

### H4 & H4C



Typical Dimensions:  
 Line Inlet (1): IEC 60320-1 C14  
 Load Terminals (2): .250 [6.3] with .07 [1.8] Dia. hole  
 Ground Terminal (1): .250 [6.3] with .07 x .16 [1.8 x 3.8] slot

### H9



Typical Dimensions:  
 Line Inlet (1): IEC 60320-1 C14  
 Load Terminals (2): .250 [6.3] with .07 [1.8] Dia. hole  
 Ground Terminal (1): .250 [6.3] with .07 x .16 [1.8 x 3.8] slot

### H5



Typical Dimensions:  
 Line Inlet (1): IEC 60320-1 C14  
 Wire Leads: 4.0 [101.6] Min., 18AWG, UL1015

### H8



Typical Dimensions:  
 Line Inlet (1): IEC 60320-1 C14  
 Wire Leads: 4.0 [101.6] Min., 18AWG, UL1015

## Recommended Panel Cutouts



Note 1: H4, H4C and H8 allow for front or back mounting  
 Note 2: H5 and H9 allow for back mounting only

**Power Inlet Line Filter for Medical Equipment** *(continued)*

# H Series

## Case Dimensions

| Part No.         | A<br>(max.)                | B<br>(max.)                | C<br>(max.)                | D<br>$\pm .015$<br>$\pm .38$ | E<br>(max.)                | F<br>(ref.)               |
|------------------|----------------------------|----------------------------|----------------------------|------------------------------|----------------------------|---------------------------|
| H1               | <b>2.25</b><br><i>57.2</i> | <b>1.82</b><br><i>46.1</i> | <b>0.66</b><br><i>16.7</i> | <b>2.125</b><br><i>53.98</i> | <b>2.53</b><br><i>64.2</i> | -                         |
| H3               | <b>.96</b><br><i>24.40</i> | <b>1.82</b><br><i>46.1</i> | <b>0.66</b><br><i>16.7</i> | <b>2.125</b><br><i>53.98</i> | <b>2.53</b><br><i>64.2</i> | -                         |
| 6EH4             | <b>2.20</b><br><i>55.9</i> | <b>1.19</b><br><i>30.2</i> | <b>0.81</b><br><i>20.6</i> | <b>1.575</b><br><i>40.01</i> | <b>1.98</b><br><i>50.3</i> | -                         |
| 10EH4,<br>10EH4C | <b>2.62</b><br><i>66.5</i> | <b>1.19</b><br><i>30.2</i> | <b>0.81</b><br><i>20.6</i> | <b>1.575</b><br><i>40.01</i> | <b>1.98</b><br><i>50.3</i> | -                         |
| 15EH4            | <b>2.62</b><br><i>66.5</i> | <b>1.19</b><br><i>30.2</i> | <b>0.81</b><br><i>20.6</i> | <b>1.575</b><br><i>40.01</i> | <b>1.98</b><br><i>50.3</i> | -                         |
| H5               | <b>1.55</b><br><i>39.4</i> | <b>1.19</b><br><i>30.2</i> | <b>0.85</b><br><i>21.6</i> | <b>1.575</b><br><i>40.01</i> | <b>1.98</b><br><i>50.3</i> | <b>.295</b><br><i>7.5</i> |
| H8               | <b>1.56</b><br><i>39.7</i> | <b>1.19</b><br><i>30.2</i> | <b>0.81</b><br><i>20.6</i> | <b>1.575</b><br><i>40.01</i> | <b>1.98</b><br><i>50.3</i> | <b>.295</b><br><i>7.5</i> |
| H9               | <b>1.55</b><br><i>39.4</i> | <b>1.19</b><br><i>30.2</i> | <b>0.85</b><br><i>21.6</i> | <b>1.575</b><br><i>40.01</i> | <b>1.98</b><br><i>50.3</i> | -                         |

## Accessories

GA400: NEMA 5-15P to IEC 60320-1 C-13 line cord



FA601: Insulating Shroud



## Performance Data

### Typical Insertion Loss

Measured in closed 50 Ohm system

#### 3EH

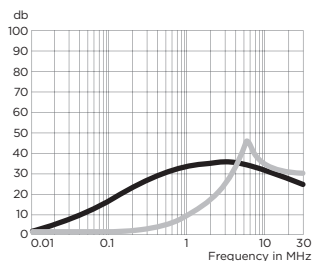

#### 6EH

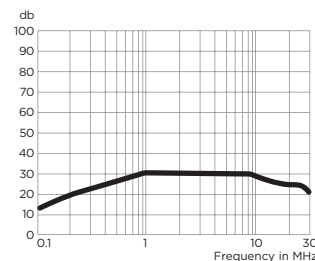

#### 10EH

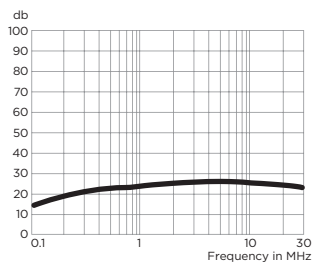

#### 15EH

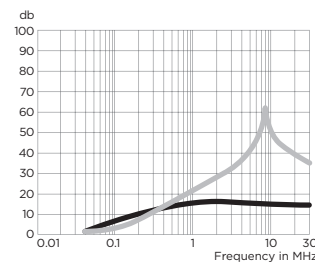

— Common Mode / Asymmetrical (L-G)  
— Differential Mode / Symmetrical (L-L)

### Minimum Insertion Loss

Measured in closed 50 Ohm system

Common Mode / Asymmetrical (Line to Ground)

| Current Rating | Frequency – MHz |    |    |    |    |    |
|----------------|-----------------|----|----|----|----|----|
|                | .15             | .5 | 1  | 5  | 10 | 30 |
| 3A             | 18              | 27 | 30 | 30 | 27 | 18 |
| 6A             | 9               | 16 | 20 | 26 | 23 | 18 |
| 10A            | 7               | 13 | 15 | 17 | 16 | 14 |
| 15A            | 5               | 9  | 11 | 12 | 11 | 9  |

**Power Entry Module with Voltage Selection and Fusing**

# J Series



UL Recognized  
CSA Certified

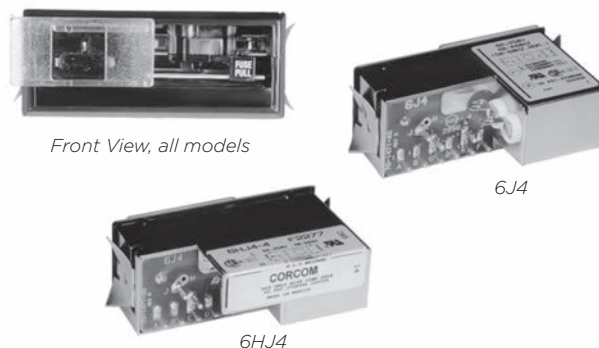

## J Series

- Power entry module with North American style 3AG fuse holder
- 2 or 4 voltage selection
- Compact snap-in design
- Two element circuit provides basic EMI attenuation
- Available with minimal leakage current suitable for medical applications (HJ models)
- Also available without filter (VJ models)

## Ordering Information



## Specifications

**Maximum leakage current each Line to Ground:**

|                 |             |                      |
|-----------------|-------------|----------------------|
|                 | 6J4 Models  | 6HJ4 or non-filtered |
| @250 VAC 50 Hz: | 500 $\mu$ A | 5 $\mu$ A            |

**Hipot rating (one minute):**

|                 |          |
|-----------------|----------|
| Line to Ground: | 1550 VAC |
| Line to Line:   | 1450 VDC |

**Operating Voltage:**

|                           |                         |
|---------------------------|-------------------------|
| suffix - 1 or - 4 models: | 100, 120, 220 or 240VAC |
| suffix - 2 models:        | 115 or 230 VAC          |

**Operating Frequency:**

50/60 Hz

**Rated Current:**

6A

**Required Fuse:**

.25 x 1.25  
*(not included)*

## Available Part Numbers

| Non-filtered models     |        |
|-------------------------|--------|
| 6VJ1                    | 6VJ1-2 |
| General Purpose Filters |        |
| 6J4                     | 6J4-2  |
| Medical Filters         |        |
| 6HJ4-4                  | 6HJ4-2 |

**Power Entry Module with Voltage Selection and Fusing** *(continued)*

# J Series

## Electrical Schematics

### 6VJ1 & 6VJ1-2



### 6J4 & 6J4-2



### 6HJ4-4 & 6J4-2



- Note 1: Jumper required if only SPST power switch is used
- Note 2: Jumpers required if no input filtering is used
- Note 3: Use only 120V and 240V positions for 2 volt selection units

## Voltage Selection



Open cover door and slide fuse-pull lever to left. Select operating voltage by orienting voltage selection card with the desired voltage on top left side. Push card firmly into module slot. Slide fuse-pull lever to right into normal position and re-insert fuse into holders.

**Use caution in selecting correct fuse value.**

## Accessories

**GA400:** NEMA 5-15P to IEC 60320-1 C-13 line cord



**JA302:** 2 Voltage Select Card

Comes standard with 6VJ1-2, 6J4-2 and 6HJ4-2

**JA304:** 4 Voltage Select Card

Comes standard with 6VJ1, 6J4 and 6HJ4-4

**JA403:** Mounting clips for .105 - .125" panels

**JA410-419:** Equipment Rating Labels

Self-adhesive, available in multiples of 40  
Specify part number



| Part No. | A          | B              | C              |
|----------|------------|----------------|----------------|
|          | VA max.    | Fuse           | Fuse           |
| JA410    | 25         | 100/120 (115V) | 220/240 (230V) |
| JA411    | 50         | 500mA          | 250mA          |
| JA412    | 100        | 1A             | 500 mA         |
| JA413    | 200        | 2A             | 1A             |
| JA414    | 250        | 2.5A           | 1.25A          |
| JA415    | 300        | 3A             | 1.5A           |
| JA416    | 400        | 4 A            | 2A             |
| JA417    | 500        | 5A             | 2.5A           |
| JA418    | 600        | 6A             | 3A             |
| JA419    | Assortment |                |                |

JA410-JA418: 40 labels of one part number

JA419: 5 each of JA410 - JA418 (45 labels)

**JA500:** Voltage Selector Card Extractor Tool



**Power Entry Module with Voltage Selection and Fusing** *(continued)*

# J Series

## Case Styles

### Non-filtered Models



Typical Dimensions:  
Line Inlet (1): IEC 60320-1 C14  
Load Terminals (2): .110 [2.79]

### Filtered Models



Typical Dimensions:  
Line Inlet (1): IEC 60320-1 C14  
Load Terminals (2): .110 [2.79]

### Recommended Panel Cutouts



Standard units mount in panel thickness of .060 - .090 [1.52 - 2.29]  
JA403 Mounting clips for .105 - .125" panels available separately  
Fuse cover door shown in open position

## Case Dimensions

| Part No.                      | A<br>(max.)         | B<br>(max.)         | C<br>(max.)         | D<br>(max.)         |
|-------------------------------|---------------------|---------------------|---------------------|---------------------|
| 6VJ1, 6VJ1-2                  | <b>2.68</b><br>68.1 | <b>1.52</b><br>38.6 | <b>1.17</b><br>29.7 | <b>1.23</b><br>31.2 |
| 6J4, 6J4-2,<br>6HJ4-4, 6HJ4-2 | <b>2.75</b><br>69.9 | <b>1.87</b><br>47.5 | <b>1.17</b><br>29.7 | <b>1.58</b><br>40.1 |

## Performance Data

### Typical Insertion Loss

Measured in closed 50 Ohm system

#### 6J4



#### 6HJ4



— Common Mode / Asymmetrical (L-G)  
- - - Differential Mode / Symmetrical (L-L)

### Minimum Insertion Loss

Measured in closed 50 Ohm system

Common Mode / Asymmetrical (Line to Ground)

| Model No. | Frequency – MHz |    |    |    |    |    |    |
|-----------|-----------------|----|----|----|----|----|----|
|           | .15             | .5 | 1  | 5  | 10 | 20 | 30 |
| 6J4       | 9               | 20 | 25 | 41 | 45 | 45 | 48 |
| 6HJ4      | 9               | 11 | 15 | 19 | 13 | 12 | 10 |



Dual Configuration Power Entry Module

# L Series



UL Recognized  
CSA Certified  
VDE Approved



## L Series

- Power entry module with switch or fuse
- For 10A capability and high performance filtering see the P Series on page 192
- Two element circuit provides extended EMI attenuation similar to EAB inlet filter
- North American or metric fuse holders
- Available with minimal leakage current for medical applications (HL models)

## Ordering Information



## Specifications

### Maximum leakage current each Line to Ground:

|                  | DL Models | HL Models |
|------------------|-----------|-----------|
| @ 120 VAC 60 Hz: | .25 mA    | 2 µA      |
| @ 250 VAC 50 Hz: | .50 mA    | 5 µA      |

### Hipot rating (one minute):

|                 |          |
|-----------------|----------|
| Line to Ground: | 2250 VDC |
| Line to Line:   | 1450 VDC |

### Operating Voltage:

|                          |                           |
|--------------------------|---------------------------|
| 1S & 1SC models (fixed): | 250 VAC max.              |
| 4 & 4C Suffix:           | 100, 120, 220 or 240 VAC. |

### Operating Frequency:

50/60 Hz

### Rated Current:

2 to 6A

### Required Fuse(s):

|                 |                                |
|-----------------|--------------------------------|
| North American: | one .25 x 1.25" (not included) |
| Metric:         | two 5 x 20mm (not included)    |

### Switch:

DPST  
10,000 operations at 51A max. inrush



**Dual Configuration Power Entry Module** *(continued)*

# L Series

| Available Part Numbers |                             | North American Fusing |         | Metric Fusing |          |
|------------------------|-----------------------------|-----------------------|---------|---------------|----------|
|                        |                             | Flange Mount          | Snap-In | Flange Mount  | Snap-In  |
| Non-Filtered           | Single Voltage, Switched    | 6EL1S                 | 6EL1SC  | 6EL1SM        | 6EL1SCM  |
|                        | 4 Voltage Select, No Switch | 6EL4                  | 6EL4C   | 6EL4M         | 6EL4CM   |
| General Purpose Filter | Single Voltage, Switched    | 2EDL1S                | 2EDL1SC | 2EDL1SM       | 2EDL1SCM |
|                        |                             | 4EDL1S                | 4EDL1SC | 4EDL1SM       | 4EDL1SCM |
|                        |                             | 6EDL1S                | 6EDL1SC | 6EDL1SM       | 6EDL1SCM |
|                        | 4 Voltage Select, No Switch | 2EDL4                 | 2EDL4C  | 2EDL4M        | 2EDL4CM  |
|                        |                             | 4EDL4                 | 4EDL4C  | 4EDL4M        | 4EDL4CM  |
|                        |                             | 6EDL4                 | 6EDL4C  | 6EDL4M        | 6EDL4CM  |
| Medical Filter         | Single Voltage, Switched    | 6EHL1S                | 6EHL1SC | 6EHL1SM       | 6EHL1SCM |
|                        | 4 Voltage Select, No Switch | 6EHL4                 | 6EHL4C  | 6EHL4M        | 6EHL4CM  |

## Voltage Selection



To change selected voltage: disconnect the power cord; open cover using a small blade screwdriver or similar tool; insert the tool into the voltage selection slot and remove wheel from unit; select desired voltage; replace wheel into unit and close cover, making sure the selected voltage appears in connector window.

## Recommended Panel Cutouts



- Notes:
- (1) For panel thickness of .031 – .079 [0.8 – 2.0]
  - (2) For panel thickness of .083 – .126 [2.1 – 3.2]
  - (3) Mounting Holes .126 [3.20] Dia. for flange mounted versions only
  - (4) For Snap-In applications, the 1.12 [28.5] sides of the cutout must have a .02 [.508] radius on the installation side. Not required for flange mount versions.

**Dual Configuration Power Entry Module** *(continued)*

# L Series

## Electrical Schematics

### DL Models

#### Single Voltage, Switched (DL1S)



#### 4 Voltage Select, No-Switch (DL4)



### HL Models

#### Single Voltage, Switched (HL1S)



#### 4 Voltage Select, No-Switch (HL4)



Note 1: Provision for dual Metric style fusing  
Note 2: On/Off switch present only with "S" suffix models

## Accessories

**GA400:** NEMA 5-15P to IEC 60320-1 C-13 line cord



**LA303:** Voltage Select Wheel, 3 position  
Selection drum for use with L4 models.  
Marked with 110V, 220V and 240V

**LA304:** Voltage Select Wheel, 4 position  
Selection drum for use with L4 models.  
Marked with 100V, 110V, 220V and 240V.  
One LA304 comes standard with each L4 model.



**LA400:** Blank insert  
Blank to replace switch in single voltage models

**LA601:** Insulating Boot  
Plastic shroud to cover back of module to prevent inadvertent access

## Replacement Fuse Holders

**LA200:** North American Fuseholder  
Accommodates one .25 x 1.25" fuse

**LA201:** Metric Fuseholder  
Accommodates one 5 x 20mm metric fuse



**Dual Configuration Power Entry Module** *(continued)*

# L Series

## Case Styles

### Flange Models, Non-filtered



*Switched model shown, for non-switched detail refer to snap-in models*

Typical Dimensions:  
Line Inlet (1): IEC 60320-1 C14  
Backplate Terminals: .110 [2.79]  
Switch Terminals: .187 [4.765] with .07 x .16 [1.8 x 3.8] slot

### Snap-in Models, Non-filtered



*Non-switched model shown, for switched detail refer to flange models*

Typical Dimensions:  
Line Inlet (1): IEC 60320-1 C14  
Backplate Terminals: .110 [2.79]  
Switch Terminals: .187 [4.765] with .07 x .16 [1.8 x 3.8] slot

### Flange Models, Filtered



*Switched model shown, for non-switched detail refer to snap-in models  
Metric fuse models have an additional jumper from filter to module*

Typical Dimensions:  
Line Inlet (1): IEC 60320-1 C14  
Backplate Terminals: .110 [2.79]  
Switch Terminals: .187 [4.765] with .07 x .16 [1.8 x 3.8] slot

### Snap-in Models, Filtered



*Non-switched model shown, for switched detail refer to flange models  
Metric fuse models have an additional jumper from filter to module*

Typical Dimensions:  
Line Inlet (1): IEC 60320-1 C14  
Backplate Terminals: .110 [2.79]  
Switch Terminals: .187 [4.765] with .07 x .16 [1.8 x 3.8] slot

## Case Dimensions

|                    | A                    | B                    | C                   | D                    | E                    | F                    |
|--------------------|----------------------|----------------------|---------------------|----------------------|----------------------|----------------------|
| <b>Model No.</b>   | (max.)               | $\pm_{-.38}^{+.015}$ | (max.)              | (max.)               | (max.)               | (ref.)               |
| Flange Unfiltered  | <b>1.98</b><br>50.29 | <b>1.575</b><br>40.0 | <b>2.3</b><br>58.42 | <b>2.14</b><br>54.36 | <b>1.66</b><br>42.16 | <b>1.11</b><br>28.19 |
| Snap-in Unfiltered | <b>1.28</b><br>32.51 | -                    | <b>2.3</b><br>58.42 | <b>2.14</b><br>54.36 | <b>1.66</b><br>42.16 | <b>1.11</b><br>28.19 |
| Flange Filtered    | <b>1.98</b><br>50.29 | <b>1.575</b><br>40.0 | <b>2.3</b><br>58.42 | <b>2.14</b><br>54.36 | <b>2.01</b><br>51.05 | <b>1.11</b><br>28.19 |
| Snap-in Filtered   | <b>1.28</b><br>32.51 | -                    | <b>2.3</b><br>58.42 | <b>2.14</b><br>54.36 | <b>2.01</b><br>51.05 | <b>1.11</b><br>28.19 |

Dual Configuration Power Entry Module *(continued)*

# L Series

## Performance Data

### Typical Insertion Loss

Measured in closed 50 Ohm system

**2EDL**



**4EDL**



**6EDL**



**6EHL**



— Common Mode / Asymmetrical (L-G)  
— Differential Mode / Symmetrical (L-L)

### Minimum Insertion Loss

Measured in closed 50 Ohm system

Common Mode / Asymmetrical (Line to Ground)

| Current Rating    | Frequency – MHz |     |    |    |    |    |
|-------------------|-----------------|-----|----|----|----|----|
|                   | .05             | .15 | 1  | 5  | 10 | 30 |
| <b>EDL Models</b> |                 |     |    |    |    |    |
| 1A                | 6               | 14  | 24 | 40 | 45 | 50 |
| 3A                | 2               | 8   | 18 | 32 | 38 | 45 |
| 6A                | 1               | 6   | 17 | 31 | 37 | 45 |
| <b>EHL Models</b> |                 |     |    |    |    |    |
| 6A                | 3               | 8   | 15 | 18 | 18 | 18 |

Differential Mode / Symmetrical (Line to Line)

| Current Rating    | Frequency – MHz |       |    |    |    |    |    |
|-------------------|-----------------|-------|----|----|----|----|----|
|                   | .05             | .15.5 | 1  | 3  | 5  | 10 | 30 |
| <b>EDL Models</b> |                 |       |    |    |    |    |    |
| 1A                | 7               | 16    | 21 | 23 | 37 | 47 | 50 |
| 3A                | 6               | 14    | 18 | 23 | 26 | 45 | 47 |
| 6A                | 6               | 15    | 20 | 25 | 24 | 45 | 50 |
| <b>EHL Models</b> |                 |       |    |    |    |    |    |
| 6A                | 4               | 14    | 20 | 28 | 32 |    |    |

**Power Entry Module with Enhanced EMI Filtering**

# LA Series



UL Recognized  
CSA Certified



## LA Series

- Power entry module with extended and enhanced low frequency filters
- North American or dual metric fuse holder options
- DPST on/off switch
- 120/240V voltage selection
- The F version provides basic performance two element circuit filter
- The X version provides a three element differential mode circuit with extended EMI attenuation, suitable for meeting FCC Part 15J, Class B conducted emissions limits
- The Z version provides a three element differential mode circuit with enhanced EMI low frequency attenuation, suitable for meeting EN55022 Level B as well as FCC Part 15J limits

## Ordering Information



\*IEC 60320-1 C14 inlet mates with C13 connector

## Specifications

### Maximum leakage current each Line to Ground:

|                 | FLA Model | XLA or ZLA Model |
|-----------------|-----------|------------------|
| @120 VAC 60 Hz: | .25 mA    | .30 mA           |
| @250 VAC 50 Hz: | .50 mA    | .50 mA           |

### Hipot rating (one minute):

|                 |          |
|-----------------|----------|
| Line to Ground: | 2250 VDC |
| Line to Line:   | 1450 VDC |

### Rated Voltage (max.):

250 VAC

### Operating Frequency:

50/60 Hz

### Rated Current:

3 to 5A

### Required Fuse(s):

one .25 x 1.25" (not included)  
or two 5 x 20mm (not included)

### Switch:

DPST  
10,000 operations at 51A max. inrush

## Available Part Numbers

|         |
|---------|
| 5EFLA2S |
| 3EXLA2S |
| 3EZLA2S |

**Power Entry Module with Enhanced EMI Filtering** *(continued)*

# LA Series

## Voltage Selection

To change selected voltage: remove the fuse cartridge using a small blade screwdriver or similar tool; select the desired voltage by matching the arrow on the fuse cartridge to the arrow located on the front of the unit (lower right corner); replace the fuse cartridge making sure the voltage selection arrow aligns with the arrow located on the front of the unit.

## Changing Fuses

Remove the fuse cartridge using a small blade screwdriver or similar tool; for Metric fusing pull out the sliding fuse covers located at the top of each fuse compartment; insert desired fuses; push the sliding fuse covers back in place and insert the fuse cartridge back into the unit making sure the voltage selection arrow aligns with the arrow located on the front of the unit. (Note: Single North American or Metric fuse placement is always on the side of the desired voltage selection arrow behind the fuse symbol; the other compartment may be used as a spare or be left blank. Dual Metric fusing capability is available for 220/240 volts only.)

## Electrical Schematics

### FLA Model



### XLA & ZLA Model



## Case Styles



Typical Dimensions:

- Line Inlet (1): IEC 60320-1 C14
- Mounting Holes (2): .142 [3.6] Dia.
- Backplate Terminals(5): .110 [2.79] with .059 [1.5] holes
- Ground: solder lug tab with wire wrap

## Case Dimensions

| Part No. | A (max.)            | B $\pm .015$<br>$\pm .38$ | C (max.)             | D (max.)             | E (max.)             | F (ref.)             |
|----------|---------------------|---------------------------|----------------------|----------------------|----------------------|----------------------|
| 5EFLA2S  | <b>1.99</b><br>50.5 | <b>1.57</b><br>39.9       | <b>2.59</b><br>65.79 | <b>2.41</b><br>61.21 | <b>3.16</b><br>68.07 | <b>1.18</b><br>29.97 |
| 3EXLA2S  | <b>1.99</b><br>50.5 | <b>1.57</b><br>39.9       | <b>2.59</b><br>65.79 | <b>2.41</b><br>61.21 | <b>4.16</b><br>105.7 | <b>1.18</b><br>29.97 |
| 3EZLA2S  | <b>1.99</b><br>50.5 | <b>1.57</b><br>39.9       | <b>2.59</b><br>65.79 | <b>2.41</b><br>61.21 | <b>4.16</b><br>105.7 | <b>1.18</b><br>29.97 |

## Recommended Panel Cutout



**Power Entry Module with Enhanced EMI Filtering** *(continued)*

# LA Series

## Performance Data

### Typical Insertion Loss

Measured in closed 50 Ohm system

**5EFLA2S**



**3EXLA2S**



**3EZLA2S**



— Common Mode / Asymmetrical (L-G)  
— Differential Mode / Symmetrical (L-L)

## Minimum Insertion Loss

Measured in closed 50 Ohm system

Common Mode / Asymmetrical (Line to Ground)

| Part No. | Frequency – MHz |     |     |    |    |    |    |    |
|----------|-----------------|-----|-----|----|----|----|----|----|
|          | .01             | .05 | .15 | .5 | 1  | 5  | 10 | 30 |
| 5EFLA2S  | -               | -   | 14  | 21 | 26 | 40 | 46 | 50 |
| 3EXLA2S  | 2               | 12  | 21  | 35 | 46 | 44 | 44 | 40 |
| 3EZLA2S  | 14              | 28  | 38  | 42 | 40 | 40 | 40 | 40 |

Differential Mode / Symmetrical (Line to Line)

| Part No. | Frequency – MHz |     |     |     |     |    |    |    |    |    |
|----------|-----------------|-----|-----|-----|-----|----|----|----|----|----|
|          | .02             | .03 | .05 | .07 | .15 | .5 | 1  | 5  | 10 | 30 |
| 5EFLA2S  | -               | -   | -   | -   | -   | -  | -  | -  | -  | -  |
| 3EXLA2S  | -               | -   | -   | 5   | 33  | 60 | 65 | 60 | 50 | 50 |
| 3EZLA2S  | 3               | 14  | 29  | 38  | 57  | 72 | 72 | 65 | 55 | 50 |



**Slim Power Entry Module Family with Multiple Options**

# M Series



UL Recognized  
CSA Certified  
VDE Approved



## Ordering Information



## M Series

- Family of slim power entry modules that consume minimal depth behind panel
- Four compact modules each provide a different option combination
- Available non-filtered or with one of four filter circuits designed to meet a wide variety of applications
- Optional voltage selector configured for either 2 or 4 voltage selection
- Optional DPST on/off switch
- Included fuseholder accepts either single 3AG fuse or dual metric fuses
- Snap-in or flange mounting styles

## Filter Types

**H Models** provide a basic performance dual element circuit EMI filter with minimal leakage current, suitable for medical applications, with attenuation similar to the EAH Series power inlet filter.

**F Models** provide a basic performance dual element circuit EMI filter, with attenuation similar to the EEA Series Power Inlet Filter.

**X Models** provide a high performance three element differential circuit filter, with extended EMI attenuation similar to the X Series chassis filter, suitable for bringing most digital equipment (including switching power supplies) into compliance with FCC Part 15J, Class B conducted emissions limits.

**Z Models** provide a premium performance three element differential circuit filter, with enhanced EMI low frequency attenuation similar to the P Series Z models, suitable for bringing most digital equipment (including switching power supplies) into compliance with EN55022 Level B as well as FCC Part 15J. For minimum panel footprint, see the P series on page 192.

**Slim Power Entry Module Family with Multiple Options** *(continued)*

# M Series

## Specifications

**Maximum leakage current each Line to Ground:**

|                  | HM        | FM     | XM/ZM  |
|------------------|-----------|--------|--------|
| @ 120 VAC 60 Hz: | 2 $\mu$ A | .25 mA | .30 mA |
| @250 VAC 50 Hz:  | 5 $\mu$ A | .50 mA | .50 mA |

**Hipot rating (one minute):**

|   |          |
|---|----------|
| Line to Ground:                         | 2250 VDC |
| Line to Line:                           | 1450 VDC |
| Line to Load (switch off) non-filtered: | 2500 VAC |

**Rated Voltage (max.):** 250VAC

**Operating Frequency:** 50/60 Hz

**Rated Current @ 120 VAC:** 3 to 6A

**Rated Current @ 250 VAC:**

|                         |    |
|-------------------------|----|
| 3A models:              | 2A |
| 5A models:              | 4A |
| 6A Switched models:     | 5A |
| 6A non-switched models: | 6A |

**Required Fuse(s):** Reversible fuseholder accepts one .25 x 1.25" (not included) or two 5 x 20mm (not included)

**Switch:** DPST  
100,000 operations at 70A max. inrush

## Available Part Numbers

| Non-Filtered Models             |              |        |         |         |
|---------------------------------|--------------|--------|---------|---------|
| Voltage Selections              | Flange Mount |        | Snap-In |         |
| 1                               | 6VM1         | 6VM1S  | 6VM1C   | 6VM1SC  |
| 2                               | 6VM2         | 6VM2S  |         |         |
| 4                               | 6VM4         | 6VM4S  | 6VM4C   | 6VM4SC  |
| General Purpose Filters         |              |        |         |         |
| 1                               | 5EFM1        | 5EFM1S | 5EFM1C  | 5EFM1SC |
| 4                               | 5EFM4        | 5EFM4S | 5EFM4C  | 5EFM4SC |
| Medical Filters                 |              |        |         |         |
| 1                               | 5EHM1        | 5EHM1S |         |         |
| 4                               | 5EHM4        | 5EHM4S |         |         |
| High Performance - FCC-B        |              |        |         |         |
| 1                               |              | 3EXM1S |         |         |
| 4                               | 3EXM4        | 3EXM4S |         |         |
| Premium Performance - EN55022-B |              |        |         |         |
| 1                               |              | 3EZM1S |         |         |
| 4                               | 3EZM4        | 3EZM4S |         |         |

## Accessories

**GA400:** NEMA 5-15P to IEC 60320-1 C-13 line cord



**MA100:** Power interconnect assembly  
For voltage select models. 8.5" wire leads



**MA101:** Plug only

**MA102:** Strip of 100 pins for use with MA101

**MA104:** Individual pins for use with MA101

**MA302:** Two Voltage Selection Card

Marked 120V/240V. One card comes standard with every 2 voltage M series module

**MA304:** Four Voltage Selection Card

Marked 100V/120V/230V/240V. One card comes standard with every 4 voltage M series module



**MA400:** Medical safety bracket assembly

Prevents inadvertent removal of fuse(s)



**MA401:** Bracket only

**MA402:** Standoff only

**Slim Power Entry Module Family with Multiple Options** *(continued)*

# M Series

## Accessories *(continued)*

### MA601 - 604: Insulating Boot

Plastic shroud for back of M series to prevent inadvertent access to connections



- MA601: Fits M4S versions
- MA602: Fits M1S versions
- MA603: Fits M4 versions
- MA604: First M1 versions

## Voltage Selection

1. Open cover, using small blade screwdriver or similar tool *(see illustration on right)*
2. Set aside cover/fuse block assembly
3. Pull voltage selector card straight out of housing, using indicator pin
4. Orient selector card so that desired voltage is readable at the bottom
5. Orient indicator pin to point up when desired voltage is readable at bottom *(note that when indicator pin is fixed, successive voltages are selected by rotating the card 90° clockwise)*
6. Insert voltage selector card into housing, printed side of card facing forward toward IEC connector and edge containing the desired voltage first
7. Replace cover, and verify that indicator pin shows the desired voltage

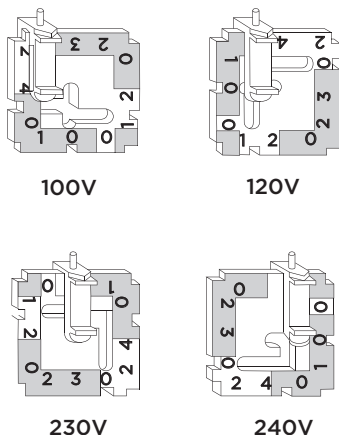

## Fuse Installation Instructions

1. Remove power cord



2. Insert a pocket screwdriver at point "X" as shown

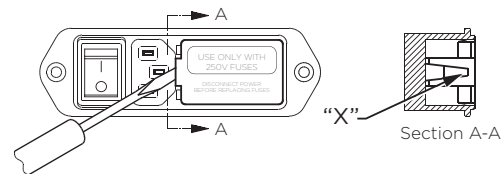

3. Gently lift the entire door UP approximately 1/4" *(minimum)*. Once lifted, the door will pivot on it's hinges to expose the fuse holder



4. When the fuse holder is installed in the single fuse position, apply the screwdriver as shown and gently lift up. Use screwdriver as shown, do not use fingers



*When the fuse holder is installed in the dual fuse position, it will normally release as soon as the door is opened*

5. Install one (1) AG fuse or two (2) metric fuses (see below)
6. Replace fuse holder into housing
7. Swing and push to snap door back in place

## Fuse Options



North American single fuse installation



Metric dual fuse installation

***Install fuses on one side only, do not install both AG and metric fuses at the same time***

**Slim Power Entry Module Family with Multiple Options** *(continued)*

# M Series

## Electrical Schematics

### Non-Filtered Models

#### VM1



#### VM2



#### VM4



- Note 1: Jumper required if no input filter is used
- Note 2: Provision for dual Metric style fusing
- Note 3: On/off switch present only in "S" suffix models
- Note 4: When using a center-tapped transformer, the C-F winding should be the low voltage (high current) winding and must be capable of handling the full primary current in the 120V position

### Filtered Models

#### FM1 & HM1



#### FM4 & HM4



#### XM1 & ZM1



#### XM4 & ZM4

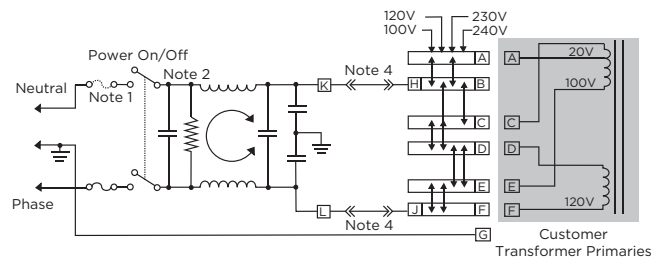

- Note 1: Provision for dual Metric style fusing
- Note 2: On/off switch present only in "S" suffix models
- Note 3: Line to ground capacitor not present on HM models
- Note 4: Models HM4, FM4, XM4 and ZM4 have added terminals K and L. External switch or jumper must be placed from K to H and L to J

**Slim Power Entry Module Family with Multiple Options** *(continued)*

# M Series

## Case Styles - Non-filtered Models

### 6VM1



Typical Dimensions:  
 Line Inlet (1): IEC 60320-1 C14  
 Backplate Terminals: .110 [2.79]  
 Mounting holes (2): .155 [3.94] Dia. with .279 [7.08] Dia. x 82°  
 countersink for #6 flathead screw

### 6VM1C



Typical Dimensions:  
 Line Inlet (1): IEC 60320-1 C14  
 Backplate Terminals: .110 [2.79]

### 6VM1S



Typical Dimensions:  
 Line Inlet (1): IEC 60320-1 C14  
 Backplate Terminals: .110 [2.79]  
 Mounting holes (2): .155 [3.94] Dia. with .279 [7.08] Dia. x 82°  
 countersink for #6 flathead screw

### 6VM1SC



Typical Dimensions:  
 Line Inlet (1): IEC 60320-1 C14  
 Backplate Terminals: .110 [2.79]

### 6VM2 & 6VM4



Typical Dimensions:  
 Line Inlet (1): IEC 60320-1 C14  
 Backplate Terminals: .110 [2.79]  
 Mounting holes (2): .155 [3.94] Dia. with .279 [7.08] Dia. x 82°  
 countersink for #6 flathead screw

### 6VM4C



Typical Dimensions:  
 Line Inlet (1): IEC 60320-1 C14  
 Backplate Terminals: .110 [2.79]

### 6VM2S & 6VM4S



Typical Dimensions:  
 Line Inlet (1): IEC 60320-1 C14  
 Backplate Terminals: .110 [2.79]  
 Mounting holes (2): .155 [3.94] Dia. with .279 [7.08] Dia. x 82°  
 countersink for #6 flathead screw

### 6VM4SC



Typical Dimensions:  
 Line Inlet (1): IEC 60320-1 C14  
 Backplate Terminals: .110 [2.79]

3  
 Power Inlet Filters & Power Entry Modules

**Slim Power Entry Module Family with Multiple Options** *(continued)*

# M Series

## Case Styles - Filtered Models

### 3EXM1S & 3EZM1S



Typical Dimensions:  
 Line Inlet (1): IEC 60320-1 C14  
 Backplate Terminals: .110 [2.79]  
 Threaded insert: 6-32 x .25  
 Mounting holes (2): .155 [3.94] Dia. with .279 [7.08] Dia. x 82° countersink for #6 flathead screw

### 3EXM4S & 3EZM4S



Typical Dimensions:  
 Line Inlet (1): IEC 60320-1 C14  
 Backplate Terminals: .110 [2.79]  
 Threaded insert: 6-32 x .25  
 Mounting holes (2): .155 [3.94] Dia. with .279 [7.08] Dia. x 82° countersink for #6 flathead screw

### 3EXM4 & 3EZM4



Typical Dimensions:  
 Line Inlet (1): IEC 60320-1 C14  
 Backplate Terminals: .110 [2.79]  
 Threaded insert: 6-32 x .25  
 Mounting holes (2): .155 [3.94] Dia. with .279 [7.08] Dia. x 82° countersink for #6 flathead screw

### 5EHM1 & 5EFM1



Typical Dimensions:  
 Line Inlet (1): IEC 60320-1 C14  
 Backplate Terminals: .110 [2.79]  
 Mounting holes (2): .155 [3.94] Dia. with .279 [7.08] Dia. x 82° countersink for #6 flathead screw

**Slim Power Entry Module Family with Multiple Options** *(continued)*

# M Series

## Case Styles - Filtered Models *(continued)*

### 5EFM1C



Typical Dimensions:  
Line Inlet (1): IEC 60320-1 C14  
Backplate Terminals: .110 [2.79]

### 5EHM1S & 5EFM1S



Typical Dimensions:  
Line Inlet (1): IEC 60320-1 C14  
Backplate Terminals: .110 [2.79]  
Mounting holes (2): .155 [3.94] Dia. with .279 [7.08] Dia. x 82° countersink for #6 flathead screw

### 5EFM1SC



Typical Dimensions:  
Line Inlet (1): IEC 60320-1 C14  
Backplate Terminals: .110 [2.79]

### 5EHM4 & 5EFM4



Typical Dimensions:  
Line Inlet (1): IEC 60320-1 C14  
Backplate Terminals: .110 [2.79]  
Mounting holes (2): .155 [3.94] Dia. with .279 [7.08] Dia. x 82° countersink for #6 flathead screw

### 5EFM4C



Typical Dimensions:  
Line Inlet (1): IEC 60320-1 C14  
Backplate Terminals: .110 [2.79]

### 5EHM4S & 5EFM4S

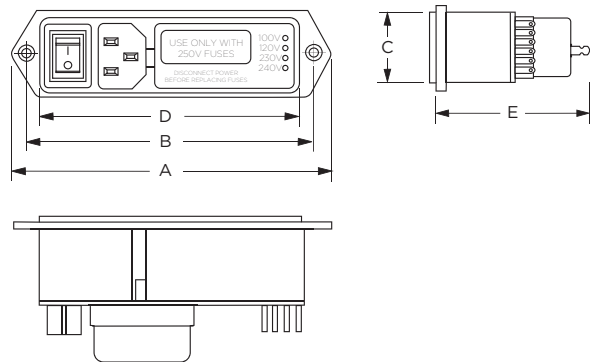

Typical Dimensions:  
Line Inlet (1): IEC 60320-1 C14  
Backplate Terminals: .110 [2.79]  
Mounting holes (2): .155 [3.94] Dia. with .279 [7.08] Dia. x 82° countersink for #6 flathead screw

**Slim Power Entry Module Family with Multiple Options** *(continued)*

# M Series

## Case Styles - Filtered Models *(continued)*

### 5EFM4SC



Typical Dimensions:  
Line Inlet (1): IEC 60320-1 C14  
Backplate Terminals: .110 [2.79]

## Recommended Panel Cutouts



Note:  
XM and ZM models allow back mount only  
FM and HM models allow front or back mounting  
Mounting holes on flange mount models only  
Snap-In models allow front mounting only  
Snap-In models panel thickness: .06 - .09 [1.53 - 2.29]

## Case Dimensions

| Part No. | A<br>(max.)          | B<br>(max.)         | C<br>(max.)         | D<br>$\pm .015$<br>$\pm .38$ | E<br>(max.)         | F<br>(ref.)         | G<br>(ref.) |
|----------|----------------------|---------------------|---------------------|------------------------------|---------------------|---------------------|-------------|
| 6VM1     | <b>3.39</b><br>86.1  | <b>2.84</b><br>72.1 | <b>1.14</b><br>29.0 | <b>2.44</b><br>62.0          | <b>1.45</b><br>36.8 | <b>2.5</b><br>63.5  | -           |
| 6VM1C    | <b>2.56</b><br>86.1  | -                   | <b>1.14</b><br>29.0 | <b>2.44</b><br>62.0          | <b>1.45</b><br>36.8 | <b>2.5</b><br>63.2  | -           |
| 6VM1S    | <b>4.17</b><br>105.9 | <b>3.62</b><br>91.9 | <b>1.14</b><br>29.0 | <b>3.22</b><br>81.8          | <b>1.45</b><br>36.8 | <b>3.28</b><br>83.3 | -           |
| 6VM1SC   | <b>3.34</b><br>84.8  | -                   | <b>1.14</b><br>29.0 | <b>3.27</b><br>83.1          | <b>1.45</b><br>36.8 | <b>3.27</b><br>83.1 | -           |
| 6VM2     | <b>3.88</b>          | <b>3.32</b>         | <b>1.14</b>         | <b>2.92</b>                  | <b>1.45</b>         | <b>2.98</b>         | -           |
| 6VM4     | 98.6                 | 84.3                | 29.0                | 74.2                         | 36.8                | 75.7                | -           |
| 6VM4C    | <b>3.04</b><br>98.6  | -                   | <b>1.14</b><br>29.0 | <b>2.92</b><br>74.2          | <b>1.45</b><br>36.8 | <b>2.97</b><br>75.4 | -           |
| 6VM2S    | <b>4.65</b>          | <b>4.1</b>          | <b>1.14</b>         | <b>3.72</b>                  | <b>1.45</b>         | <b>3.76</b>         | -           |
| 6VM4S    | 118.1                | 104.1               | 29.0                | 94.5                         | 36.8                | 95.5                | -           |
| 6VM4SC   | <b>3.82</b><br>97.0  | -                   | <b>1.14</b><br>29.0 | <b>3.7</b><br>94.0           | <b>1.45</b><br>36.8 | <b>3.75</b><br>95.3 | -           |
| 3EXM1S   | <b>4.17</b>          | <b>3.62</b>         | <b>1.14</b>         | <b>3.22</b>                  | <b>1.72</b>         | <b>3.28</b>         | <b>3.3</b>  |
| 3EZM1S   | 105.9                | 91.9                | 29.0                | 81.8                         | 43.7                | 83.8                | 83.8        |
| 3EXM4    | <b>3.88</b>          | <b>3.32</b>         | <b>1.14</b>         | <b>2.92</b>                  | <b>1.72</b>         | <b>2.98</b>         | <b>2.99</b> |
| 3EZM4    | 98.6                 | 84.3                | 29.0                | 74.2                         | 43.7                | 75.7                | 75.9        |
| 3EXM4S   | <b>4.65</b>          | <b>4.1</b>          | <b>1.14</b>         | <b>3.72</b>                  | <b>1.72</b>         | <b>3.76</b>         | <b>3.8</b>  |
| 3EZM4S   | 118.1                | 104.1               | 29.0                | 94.5                         | 43.7                | 95.5                | 96.5        |
| 5EHM1    | <b>3.39</b>          | <b>2.84</b>         | <b>1.14</b>         | <b>2.44</b>                  | <b>2.19</b>         | <b>2.5</b>          | -           |
| 5EFM1    | 86.1                 | 72.1                | 29.0                | 62.0                         | 55.6                | 63.5                | -           |
| 5EFM1C   | <b>2.56</b><br>65.0  | -                   | <b>1.14</b><br>29.0 | <b>2.44</b><br>62.0          | <b>2.19</b><br>55.6 | <b>2.49</b><br>63.2 | -           |
| 5EHM1S   | <b>4.17</b>          | <b>3.62</b>         | <b>1.14</b>         | <b>3.22</b>                  | <b>2.19</b>         | <b>3.28</b>         | -           |
| 5EFM1S   | 105.9                | 91.9                | 29.0                | 81.8                         | 55.6                | 83.3                | -           |
| 5EFM1SC  | <b>3.34</b><br>84.8  | -                   | <b>1.14</b><br>29.0 | <b>3.27</b><br>83.1          | <b>2.19</b><br>55.6 | <b>3.27</b><br>83.1 | -           |
| 5EHM4    | <b>3.88</b>          | <b>3.32</b>         | <b>1.14</b>         | <b>2.92</b>                  | <b>2.19</b>         | <b>2.98</b>         | -           |
| 5EFM4    | 98.6                 | 84.3                | 29.0                | 74.2                         | 55.6                | 75.7                | -           |
| 5EFM4C   | <b>3.04</b><br>77.2  | -                   | <b>1.14</b><br>29.0 | <b>2.92</b><br>74.2          | <b>2.19</b><br>55.6 | <b>2.97</b><br>74.4 | -           |
| 5EHM4S   | <b>4.65</b>          | <b>4.1</b>          | <b>1.14</b>         | <b>3.7</b>                   | <b>2.19</b>         | <b>3.76</b>         | -           |
| 5EFM4S   | 118.1                | 104.1               | 29.0                | 94.0                         | 55.6                | 95.5                | -           |
| 5EFM4SC  | <b>3.82</b><br>97.0  | -                   | <b>1.14</b><br>29.0 | <b>3.7</b><br>94.0           | <b>2.19</b><br>55.6 | <b>3.75</b><br>95.3 | -           |



**Slim Power Entry Module Family with Multiple Options** *(continued)*

# M Series

## Performance Data

### Typical Insertion Loss

Measured in closed 50 Ohm system

**5EHM**



**5EFM**



**3EXM**



**3EZM**



— Common Mode / Asymmetrical (L-G)  
— Differential Mode / Symmetrical (L-L)

### Minimum Insertion Loss

Measured in closed 50 Ohm system

Common Mode / Asymmetrical (Line to Ground)

| Part No.    | Frequency – MHz |     |     |    |    |    |    |    |
|-------------|-----------------|-----|-----|----|----|----|----|----|
|             | .01             | .05 | .15 | .5 | 1  | 5  | 10 | 30 |
| 5EHM Models | -               | -   | 14  | 18 | 19 | 22 | 22 | 17 |
| 5EFM Models | -               | -   | 14  | 21 | 26 | 40 | 45 | 40 |
| 3EXM Models | 2               | 13  | 23  | 40 | 46 | 44 | 44 | 44 |
| 3EZM Models | 15              | 29  | 39  | 46 | 43 | 40 | 40 | 40 |

Differential Mode / Symmetrical (Line to Line)

| Part No.    | Frequency – MHz |     |     |     |     |    |    |    |    |    |
|-------------|-----------------|-----|-----|-----|-----|----|----|----|----|----|
|             | .02             | .03 | .05 | .07 | .15 | .5 | 1  | 5  | 10 | 30 |
| 3EXM Models | -               | -   | -   | 5   | 34  | 62 | 68 | 60 | 50 | 40 |
| 3EZM Models | 5               | 13  | 28  | 37  | 55  | 75 | 75 | 62 | 54 | 44 |

Versatile Power Entry Module with Small Footprint

# P Series



UL Recognized  
CSA Certified  
VDE Approved



## P Series

The P series CHAMELEON power entry module offers the most popular features in a small footprint design. As the first 10A module to provide all five power entry functions in one compact design, the chameleon module readily adapts to its environment and the needs of international markets.

- Snap-in or flange mounting
- Standard IEC 60321-1 C14 power inlet
- Both North American and metric fusing capabilities
- Two voltage selection options (for 4-voltage selection, see the M, L or LA Series)
- Optional DPST on/off switch
- Filter options for general purpose, medical and high-performance EMI filtering

The CHAMELEON module's compact design and modular construction allows selection of the required power entry feature — without altering the panel cutout. And the CHAMELEON module, with its optional adapters, will fit several common panel cutouts.

## Filter Types

The CHAMELEON module has four filter and one non-filtered option:

**S models** provide an extended performance two element circuit EMI filter, with attenuation similar to the EEB Series power inlet filter. It offers protection for general purpose applications with stray Line to Ground and Line to Line noise that must be attenuated at the power inlet. These filters have limited leakage current and are available in current ratings of 3, 6 and 10A.

**H models** provide susceptibility protection with minimal leakage current, and are suitable for patient care and non-patient care medical equipment.

**L models** feature a high performance medical filter designed to help bring most digital equipment (including switching power supplies) into compliance with EN55022, Level B (as well as FCC part 15J, Class B) conducted emissions limits. They are available with current ratings of 6 and 10A. These high performance versions are only available with mounting ears, single voltage selection, in a complete RFI shield with options for switch, fuses and current ratings. Mounting extenders are not compatible with the L or Z models.

**Z models** provide a high performance three element differential mode circuit filter, with extended EMI attenuation similar to the M Series Z models, to help bring most digital equipment (including switching power supplies) into compliance with EN55022, Level B (as well as FCC Part 15J, Class B) conducted emissions limits. They are available with current ratings of 6 and 10A. These high performance versions are only available with mounting ears, single voltage selection, in a complete RFI shield with options for switch, fuses and current ratings. Mounting extenders are not compatible with the L or Z models. For minimum depth behind the panel, see the M Series

**B models** are non-filtered and incorporate an inter-connection block. The block connects the voltage selection terminals of an unfiltered CHAMELEON module with an IEC connector and an optional switch to reduce external wiring. Compatible with the A or B RFI shield options.

**Versatile Power Entry Module with Small Footprint** *(continued)*

# P Series

## Ordering Information

Part numbers are constructed by selecting the alphanumeric character which represents the desired feature.  
**Note: For any option where shown as "0" use the digit ZERO (0) not the letter (O).**

| Mounting Style   | Extender Options <sup>1</sup>  | Switch Options*  | Voltage Select <sup>2</sup>  | Fuse Options  | Filter Type  | Filter Current  | Shield Options <sup>1</sup>   |          |
|--|--|--|--|---|--|---|---|----------|
| <b>P</b>   | <b>S</b>   | <b>J</b>   | <b>O</b>   | <b>X</b>  | <b>S</b>   | <b>S</b>  | <b>6</b>  | <b>O</b> |
| <b>Mounting Style</b><br>E = Mounting ears (Horizontal axis)<br>S = Snap-in<br>M = Mounting ears (Vertical axis) | <b>Extender Option</b><br>O = None<br>C = FN260<br>J = J Series<br>L = L Series <sup>1</sup> | <b>Switch Option</b><br>O = Blank<br>S = Double pole single throw (DPST) | <b>Input Voltage Select</b><br>O = Single voltage<br>S = Dual voltage <sup>2</sup> select (SMPS)<br>X = Dual voltage <sup>2</sup> select (series/parallel) | <b>Fuse Options</b><br>D = Dual fuse<br>S = Single fuse | <b>Filter Type</b><br>O = No filter<br>B = Interconnection block <sup>3</sup><br>H = Medical Filter<br>L = High Performance Medical <sup>4</sup><br>S = General purpose<br>Z = High Performance <sup>4</sup> | <b>Filter Current</b><br>O = No filter<br>3 = 3A<br>6 = 6A<br>X = 10A | <b>Shield Options</b><br>O = No shield<br>A = Filter shield<br>B = Complete Shield<br>C = Complete can (for L & Z models) |          |



**Notes:**

- 1 L Series extender cannot be added to units with a shield. No style of extender can be added to units with B or C shields.
  - 2 Dual voltage options are not available with L or Z Filter Types
  - 3 When using the interconnection block, the last 3 digits of the part number are BX (O, A, or B)
  - 4 High performance versions (L or Z filter types) are available with any switch or fuse option but only in 6 or 10A with horizontal (PE) or vertical (PM) mounting ears, single voltage (O), complete shield (C) and no extenders
- \* For alternative switch orientation options, please contact technical support or your Corcom product sales representative

The part number **PS0SXSS6B** would represent:  
 P Series (P) with a snap-in mount (S) with no extender (O) a switch (S) dual voltage select (X) single fusing (S) general purpose filter (S) for 6A (6) with a B shield (B)

**Versatile Power Entry Module with Small Footprint** *(continued)*

# P Series

## Voltage Selection

P series power entry modules include the voltage selector integral with the fuse holder. Three voltage selection options are each supported by one of three different fuse holders. The fifth digit of the part number specifies which of the three fuse holders is included to provide the desired voltage selection. The single voltage fuse holder (option "O") has no voltage indication markings. The dual voltage options select 115V or 230V by removing the fuse holder, flipping it over, and reinstalling it. Voltage selection is indicated through a window in the P Series door. The "SMPS" fuse holder (option "S") jumpers two independent P Series terminals to indicate 230V operation to a switching mode power supply. The "PRSR" parallel/serial fuse holder (option "X") connects the windings of the equipment's dual primary transformer (not included) to step down the voltage or double up the current. The markings on the voltage selection fuse holders also remind the user to install the appropriate fuse for the current at the selected voltage.

## Input Voltage Selection Schemes

### S - "SPMS" Jumper Type



### X - "PRSR" Parallel / Serial Type for Dual Primary Transformer



Note 1: Additional jumper wiring is required if a filter or interconnection module is not used.  
Note 2: Location of optional filter. Additional jumper wiring is required if a filter or interconnection block is not used.

## Shield Options

The P series offers several RF shield options. The metal shield, optional on S, H and B filtered models, provides shielding from radiated emissions and provides an RF ground for the filter to the panel. This shield is available in two versions; a shield of the filter components (designated by an A as the final digit) and a complete shield (designated by B as the final digit).

The A shield covers the filter portion of the module and increases performance of the filter by protecting the components from RFI coupling. This shield allows the use of the C or J extender.

The B shield covers the entire power entry module with metal, protecting the filter from RFI coupling, and covering the mounting cut-out to block RFI entering or leaving the equipment. The B shield cannot be used with any extender.

A complete metal enclosure is integral to both the high performance L and Z models, and must be specified by a C in the part number's final digit. This option is only available with the L or Z models.



"A" Shield



"B" Shield

**Versatile Power Entry Module with Small Footprint** *(continued)*

# P Series

## Fuseholder

Another feature of the P series power entry module is the versatile fusing arrangement. The fuse holder can hold two 1/4" x 1-1/4" (3AG) or 5 x 20mm (metric) fuses. Single fusing is supported with a conversion clip that shorts one of the two fuse positions, and is designated by an S in the sixth part number digit. A module designated for a single fuse may be reconfigured by the manufacturer or the user to accept two fuses by simply removing the shorting clip. For applications intended for dual fusing, specify a D in the sixth part number digit.



## Interconnection Block

Installation of the unfiltered versions of the P series requires wiring of the IEC socket terminals to the optional switch and the switch to the fuse holder. Labor can be eliminated by ordering the module with an interconnection block. This feature, designated by "BX" in the seventh and eighth digits, prewires the module so that only connection to the equipment must be done during installation. The interconnection block includes a plastic case to prevent access to the internal connections.

**The dimensions of this alternative are the same as the filtered versions.**



## Accessories

**GA400:** NEMA 5-15P to IEC 60320-1 C-13 line cord



**PA100:** Power interconnect assembly  
For voltage select models. Designed for use with either filtered or non-filtered units, 6" wire leads



**PA101:** Plug only

**PA102:** Pins only for use with PA101

**PA105:** Same as PA100 but with two wires for units with no voltage selection

**PA400:** J Extender

Extends P Series height to fit J panel cutout

**PA410:** L Extender

Extends P Series width to fit L panel cutout

**PA420:** C Extender

Extends P Series height to fit C panel cutout



PA400  
J Series Extender

*C & L Extenders can not be used with B Shields.  
L Extender can not be used with shields*

**Versatile Power Entry Module with Small Footprint** *(continued)*

# P Series

## Specifications

Maximum leakage current each Line to Ground:

|                  | H & L Models | S & Z Models |
|------------------|--------------|--------------|
| @ 120 VAC 60 Hz: | 2 $\mu$ A    | .25 mA       |
| @ 250 VAC 50 Hz: | 5 $\mu$ A    | .50 mA       |

**Hipot rating (one minute):**

|                 |          |
|-----------------|----------|
| Line to Ground: | 2250 VDC |
| Line to Line:   | 1450 VDC |

**Rated Voltage(max.):** 250VAC

**Operating Voltages:**  
Selectable or Fixed 115/230 VAC

**Operating Frequency:** 50/60 Hz

**Rated Current:**  
Non-Filtered - 10A  
Filtered - 3, 6 or 10A

**Fuseholder:** Accepts one or two fuses  
.25 x 1.25" (not included)  
or 5 x 20mm (not included)

**Switch:** DPST  
10,000 operations at 51A max. inrush

## Electrical Schematics

### H Model



### S Model



### L Model



### Z Model



## Case Styles

### Front View



Typical Dimensions:

|                     |  |
|---------------------|--|
| Line Inlet (1):     | IEC 60320-1 C14  |
| Mounting holes (2): | .135 [3.43] Dia. with .23 [5.9] Dia. x 82° countersink for #4 flathead screw (PM, PE only) |

Versatile Power Entry Module with Small Footprint *(continued)*

# P Series

## Case Styles *(continued)*

### Extender Options

C Extender - FN260



J Extender - J Series



### Standard Models - Side and Rear View

Non-Filtered



Filtered



Typical Dimensions:

- Terminals: .187 [4.8] with .055 [1.4] Dia. hole. Recommended for use with mating connectors - no solder
- Ground Terminal (1): .187 [4.8] with .112 x .06 [2.8 x 1.5] slot. Recommended for use with mating connectors - no solder

### High Performance Models - Side and Rear View



Typical Dimensions:

- Terminals: .250 [6.4] with .07 [1.8] Dia. hole. Recommended for use with mating connectors - no solder
- Ground Terminal (1): .250 [6.4] with .16 x .07 [4.1 x 1.8] slot. Recommended for use with mating connectors - no solder

**Versatile Power Entry Module with Small Footprint** *(continued)*

# P Series

## Case Styles *(continued)*

### Shield Options



Note: Shields can only be used with filtered models. B shield may not be used with J or C extender

### Recommended Panel Cutout



Note: For snap-in applications, the "A" sides must have a .020 [.508] radius on the installation side. Dimensions are for front mount applications. Rear mount dimensions should be determined based on customer's application parameters. Snap-in models allow for front mounting only. Not recommended for use in plastic panels.

| Style | Dimension "A"<br>+.008 - .000 |              |                  | Dimension "B"<br>+.008 - .000 |                  |
|-------|-------------------------------|--------------|------------------|-------------------------------|------------------|
|       | No Shield                     | Shielded     | High Performance | Standard                      | High Performance |
| PM    | 1.06 [26.92]                  | 1.12 [28.45] | 1.12 [28.45]     | 2.13 [54.10]                  | 2.201 [55.97]    |
| PE    | 1.12 [28.45]                  | 1.12 [28.45] | 1.15 [29.27]     | 2.201 [55.97]*                | 2.201 [55.97]    |
| PS    | 1.06 [26.92]                  | 1.12 [28.45] | -                | 2.201 [55.97]*                | -                |
| PSC   | 1.06 [26.92]                  | 1.12 [28.45] | -                | 2.52 [64.07]                  | -                |
| PSJ   | 1.06 [26.92]                  | 1.12 [28.45] | -                | 2.60 [66.04]                  | -                |
| PSL   | 1.12 [28.45]                  | -            | -                | 2.201 [55.97]*                | -                |

\*For panel thickness of 0.031 - 0.079 [.787 - 2.01] only. Use 2.213 [56.21] for panel thickness of 0.083 - 0.114 [2.0 - 2.90]



Versatile Power Entry Module with Small Footprint *(continued)*

# P Series

## Performance Data

### Typical Insertion Loss

Measured in closed 50 Ohm system

— Common Mode / Asymmetrical (L-G)  
— Differential Mode / Symmetrical (L-L)

### S Models



### H Models



### L Models



### Z Models



**Versatile Power Entry Module with Small Footprint** *(continued)*

# P Series

## Minimum Insertion Loss

Measured in closed 50 Ohm system

Common Mode / Asymmetrical (Line to Ground)

| Current Rating  | Frequency – MHz |    |     |    |    |    |    |    |    |
|-----------------|-----------------|----|-----|----|----|----|----|----|----|
|                 | .03             | .1 | .15 | .5 | 1  | 3  | 5  | 10 | 30 |
| <b>S Models</b> |                 |    |     |    |    |    |    |    |    |
| 3A              | 7               | 17 | 21  | 27 | 33 | 40 | 44 | 50 | 32 |
| 6A              | -               | 8  | 12  | 17 | 23 | 32 | 36 | 44 | 30 |
| 10A             | -               | 3  | 5   | 10 | 13 | 23 | 27 | 35 | 27 |
| <b>H Models</b> |                 |    |     |    |    |    |    |    |    |
| 3A              | 7               | 17 | 21  | 27 | 30 | 29 | 26 | 23 | 15 |
| 6A              | -               | 8  | 11  | 15 | 17 | 19 | 18 | 16 | 13 |
| 10A             | 3               | 5  | 8   | 10 | 12 | 11 | 11 | 10 | 10 |

Differential Mode / Symmetrical (Line to Line)

| Current Rating  | Frequency – MHz |     |    |    |    |    |    |    |
|-----------------|-----------------|-----|----|----|----|----|----|----|
|                 | .10             | .15 | .5 | 1  | 3  | 5  | 10 | 30 |
| <b>S Models</b> |                 |     |    |    |    |    |    |    |
| 3A              | 2               | 4   | 12 | 15 | 30 | 48 | 50 | 45 |
| 6A              | 2               | 4   | 12 | 15 | 22 | 42 | 55 | 45 |
| 10A             | 2               | 4   | 12 | 15 | 22 | 42 | 55 | 45 |
| <b>H Models</b> |                 |     |    |    |    |    |    |    |
| 3A              | 2               | 4   | 12 | 18 | 31 | 40 | 48 | 41 |
| 6A              | 2               | 4   | 12 | 16 | 26 | 35 | 40 | 35 |
| 10A             | 2               | 4   | 12 | 16 | 26 | 33 | 40 | 32 |

| Current Rating  | Frequency – MHz |     |    |     |    |    |    |    |    |
|-----------------|-----------------|-----|----|-----|----|----|----|----|----|
|                 | .01             | .05 | .1 | .15 | .5 | 1  | 5  | 10 | 30 |
| <b>L Models</b> |                 |     |    |     |    |    |    |    |    |
| 6A              | 8               | 21  | 27 | 29  | 34 | 35 | 25 | 21 | 16 |
| 10A             | 5               | 17  | 22 | 23  | 24 | 25 | 21 | 18 | 14 |
| <b>Z Models</b> |                 |     |    |     |    |    |    |    |    |
| 6A              | 8               | 21  | 27 | 30  | 37 | 43 | 49 | 52 | 42 |
| 10A             | 5               | 17  | 22 | 24  | 27 | 32 | 52 | 47 | 40 |

| Current Rating  | Frequency – MHz |     |    |     |    |    |    |    |    |
|-----------------|-----------------|-----|----|-----|----|----|----|----|----|
|                 | .01             | .05 | .1 | .15 | .5 | 1  | 5  | 10 | 30 |
| <b>L Models</b> |                 |     |    |     |    |    |    |    |    |
| 6A              | 10              | 15  | 34 | 44  | 75 | 75 | 75 | 70 | 60 |
| 10A             | 10              | 20  | 20 | 35  | 67 | 75 | 75 | 70 | 60 |
| <b>Z Models</b> |                 |     |    |     |    |    |    |    |    |
| 6A              | 10              | 15  | 34 | 44  | 75 | 75 | 75 | 70 | 60 |
| 10A             | 10              | 20  | 20 | 35  | 67 | 75 | 75 | 70 | 60 |

Power Inlet Connectors

# SR Series



UL Recognized  
CSA Certified  
VDE Approved\*



## SR Series

- Full Line of popular AC receptacles
- Male and female power line connectors
- Snap-in and flange mount versions
- IEC60320-1 C-13 & C14 inlets rated up to 15A
- IEC60320-1 C-19 & C-20 inlets rated up to 20A

## Ordering Information



\*15A versions are VDE approved at 10A, 250VAC max.  
20A versions are VDE approved at 16A, 250VAC max.

## Specifications

**Rated Voltage (max.):** 250 VAC

**Materials:**

- Insulator:** Thermoplastic UL 94V-0 flame rating
- Prongs:** Solid brass, nickel plated
- Terminals:** Brass, tin plated

**Temperature Rating:** For "cold" connections, 65°C

## Available Part Numbers

| Type         | Male Connector | Female Connector |
|--------------|----------------|------------------|
| PC Pins      | 6ESRM-P        |                  |
| Snap-In      | 6ESRMC2        | 6ESRFC3          |
| Flange Mount | 6ESRM-3        | 6ESRF-3          |
| Snap-In      | 20ESRMC2       |                  |
| Flange Mount | 20ESRM-3       |                  |

## Case Styles

### 6ESRM-P



Power Inlet Connectors (continued)

# SR Series

## Case Styles (continued)

### 6ESRMC2



Typical Dimensions:  
Front Connector: IEC 60320-1 C14  
Rear Terminals: .187 [4.8] with .07 [1.8] Dia. hole

### 6ESRFC3



Typical Dimensions:  
Front Connector: IEC 60320-1 C13  
Rear Terminals: .25 [6.3] with .07 [1.8] Dia. hole

### 6ESRM-3



Cutout Dimensions:

|    | Rear Mount   | Front Mount  |
|----|--------------|--------------|
| G: | 1.19 [30.23] | 1.079 [27.4] |
| H: | 0.894 [22.7] | 0.779 [19.8] |
| R: | 0.232 [5.9]  | 0.197 [5.0]  |

Typical Dimensions:  
Front Connector: IEC 60320-1 C14  
Rear Terminals: .25 [6.3] with .07 [1.8] Dia. hole

### 6ESRF-3



Typical Dimensions:  
Front Connector: IEC 60320-1 C13  
Rear Terminals: .25 [6.3] with .07 [1.8] Dia. hole

### 20ESRMC2



Typical Dimensions:  
Front Connector: IEC 60320-1 C20  
Rear Terminals: .25 [6.3] with .07 [1.8] Dia. hole

### 20ESRM-3



Typical Dimensions:  
Front Connector: IEC 60320-1 C20  
Rear Terminals: .25 [6.3] with .07 [1.8] Dia. hole

## Case Dimensions

| Part No. | A<br>(max.) | B<br>$\begin{matrix} +.017 - .006 \\ +.43 - .15 \end{matrix}$ | C<br>(max.) | D<br>(max.) | E<br>(max.) |
|----------|-------------|---|-------------|-------------|-------------|
| 6ESRM-P  | 1.96        | 1.575   | 1.094       | 1.118       | .807        |
|          | 49.8        | 40.0  | 27.8        | 28.39       | 20.5        |
| 6ESRMC2  | 1.182       | -   | .885        | -           | 1.192       |
|          | 30.00       |   | 22.5        |             | 30.3        |
| 6ESRFC3  | 1.39        | -   | 1.09        | -           | 1.496       |
|          | 35.5        |   | 27.8        |             | 38.0        |
| 6ESRM-3  | 1.96        | 1.575   | .885        | 1.19        | 1.275       |
|          | 49.8        | 40.0  | 22.5        | 30.23       | 32.4        |
| 6ESRF-3  | 1.953       | 1.575   | 1.133       | -           | 1.496       |
|          | 49.6        | 40.0  | 28.8        |             | 38.0        |
| 20ESRMC2 | 1.377       | .921  | 1.06        | -           | -           |
|          | 35.0        | 23.4  | 27.0        |             |             |
| 20ESRM-3 | 2.087       | 1.653   | .999        | -           | 1.318       |
|          | 53.0        | 42.0  | 25.4        |             | 33.5        |

**Minimum Depth, Cost-effective Shielded Power Inlet Filter**

# SRB Series



UL Recognized  
CSA Certified  
VDE Approved\*



## SRB Series

- Smallest depth Corcom RFI filter available
- Complete shield
- Wide range of capacitor values
- Attenuates coupled EMI up to 300MHz
- Minimal to low leakage current versions are suitable for patient and non-patient contact medical equipment.
- Full range of mounting and termination options including unique vertical and horizontal orientation slide in mounts eliminate the need for mounting hardware

## Ordering Information

15 SRB S 1 - Q

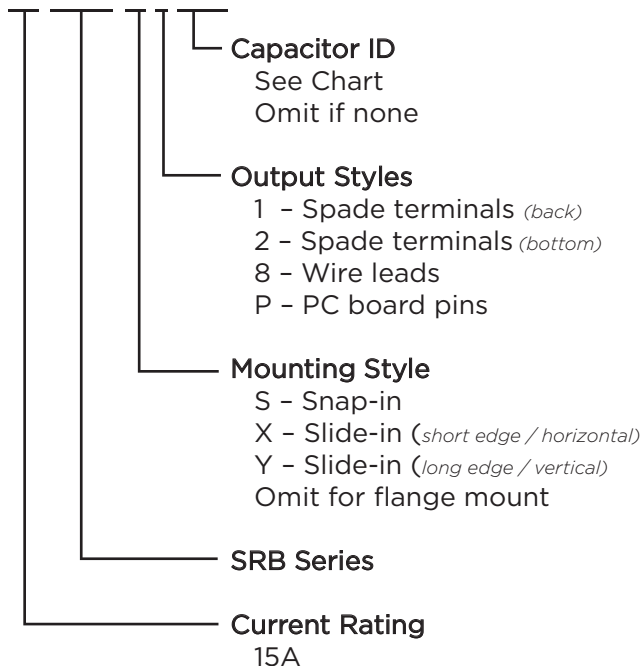

\*15A versions are tested by Underwriters Laboratories to US and Canadian requirements and are VDE approved at 10A, 250VAC

## Specifications

### Maximum leakage current each Line to Ground:

| Capacitor ID / Value | @120 VAC | @250 VAC |
|----------------------|----------|----------|
| Blank / None         | 2 µA     | 5 µA     |
| Q / 33 pF            | 2.1 µA   | 3.65 µA  |
| R / 100 pF           | 9.6 µA   | 16.6 µA  |
| S / 220 pF           | 19.2 µA  | 33.2 µA  |
| T / 330 pF           | 24.0 µA  | 41.5 µA  |
| W / 470 pF           | 0.04 mA  | 0.07 mA  |
| X / 1000 pF          | 0.07 mA  | 0.13 mA  |
| Y / 2200 pF          | 0.16 mA  | 0.28 mA  |
| Z / 3300 pF          | 0.24 mA  | 0.42 mA  |

### Hipot rating (one minute):

|                 |          |
|-----------------|----------|
| Line to Ground: | 2250 VDC |
| Line to Line:   | 1450 VDC |

### Rated Voltage (max.):

250 VAC

### Operating Frequency:

50/60 Hz

### Rated Current:

15A\*

### Operating Ambient Temperature Range

(at rated current  $I_r$ ): -10°C to +40°C  
In an ambient temperature ( $T_a$ ) higher than +40°C the maximum operating current ( $I_o$ ) is calculated as follows:  $I_o = I_r \sqrt{(85-T_a)/45}$

## Capacitor Options

| Capacitor ID | Capacitor Value |
|--------------|-----------------|
| Q            | 33 pF           |
| R            | 100 pF          |
| S            | 220 pF          |
| T            | 330 pF          |
| W            | 470 pF          |
| X            | 1000 pF         |
| Y*           | 2200 pF         |
| Z*           | 3300 pF         |

\*Not available in SRB8, SRBX or SRBY styles

**Minimum Depth, Cost-effective Shielded Power Inlet Filter** *(continued)*

# SRB Series

## Available Part Numbers

### Flange Mount

|          |          |          |          |
|----------|----------|----------|----------|
| 15SRB1   | 15SRB2   | 15SRBP   | 15SRB8   |
| 15SRB1-Q | 15SRB2-Q | 15SRBP-Q | 15SRB8-Q |
| 15SRB1-R | 15SRB2-R | 15SRBP-R | 15SRB8-R |
| 15SRB1-S | 15SRB2-S | 15SRBP-S | 15SRB8-S |
| 15SRB1-T | 15SRB2-T | 15SRBP-T | 15SRB8-T |
| 15SRB1-W | 15SRB2-W | 15SRBP-W | 15SRB8-W |
| 15SRB1-X | 15SRB2-X | 15SRBP-X | 15SRB8-X |
| 15SRB1-Y | 15SRB2-Y | 15SRBP-Y |          |
| 15SRB1-Z | 15SRB2-Z | 15SRBP-Z |          |

### Snap-In

### Slide-In

|           |           |           |           |
|-----------|-----------|-----------|-----------|
| 15SRBS1   | 15SRBS8   | 15SRBX8   | 15SRBY8   |
| 15SRBS1-Q | 15SRBS8-Q | 15SRBX8-Q | 15SRBY8-Q |
| 15SRBS1-R | 15SRBS8-R | 15SRBX8-R | 15SRBY8-R |
| 15SRBS1-S | 15SRBS8-S | 15SRBX8-S | 15SRBY8-S |
| 15SRBS1-T | 15SRBS8-T | 15SRBX8-T | 15SRBY8-T |
| 15SRBS1-W | 15SRBS8-W | 15SRBX8-W | 15SRBY8-W |
| 15SRBS1-X | 15SRBS8-X | 15SRBX8-X | 15SRBY8-X |
| 15SRBS1-Y |           |           |           |
| 15SRBS1-Z |           |           |           |

## Electrical Schematic



## Accessories

GA400: NEMA 5-15P to IEC 60320-1 C-13 line cord



## Case Styles

### SRB1



Typical Dimensions:  
 Mounting holes (2): .132 [3.35] Dia. with .236 [5.99] Dia. x 90° countersink for #4 flathead screw  
 Line Inlet (1): IEC 60320-1 C14  
 Load Terminals (2): .250 [6.3] with .07 [1.8] Dia. hole  
 Ground Terminal (1): .250 [6.3] with .07 x .16 [1.8 x 3.8] slot

### SRB2



Typical Dimensions:  
 Mounting holes (2): .132 [3.35] Dia. with .236 [5.99] Dia. x 90° countersink for #4 flathead screw  
 Line Inlet (1): IEC 60320-1 C14  
 Load Terminals (2): .250 [6.3] with .07 [1.8] Dia. hole  
 Ground Terminal (1): .250 [6.3] with .07 x .16 [1.8 x 3.8] slot

### SRBP



Typical Dimensions:  
 Mounting holes (2): .132 [3.35] Dia. with .236 [5.99] Dia. x 90° countersink for #4 flathead screw  
 Line Inlet (1): IEC 60320-1 C14  
 PC board pins (3): .031 [0.7] square, ± .003 [.07]

### SRBS1



Typical Dimensions:  
 Line Inlet (1): IEC 60320-1 C14  
 Load Terminals (2): .250 [6.3] with .07 [1.8] Dia. hole  
 Ground Terminal (1): .250 [6.3] with .07 x .16 [1.8 x 3.8] slot

Minimum Depth, Cost-effective Shielded Power Inlet Filter (continued)

# SRB Series

## Case Styles (continued)

### SRB8



Typical Dimensions:  
 Mounting holes (2): .132 [3.35] Dia. with .236 [5.99] Dia. x 90° countersink for #4 flathead screw  
 Line Inlet (1): IEC 60320-1 C14  
 Wire Leads: 4.0 [101.6] Min., 18AWG, UL1015

### SRBS8



Typical Dimensions:  
 Line Inlet (1): IEC 60320-1 C14  
 Wire Leads: 4.0 [101.6] Min., 18AWG, UL1015

### SRBX8



Typical Dimensions:  
 Line Inlet (1): IEC 60320-1 C14  
 Wire Leads: 4.0 [101.6] Min., 18AWG, UL1015

### SRBY8



Typical Dimensions:  
 Line Inlet (1): IEC 60320-1 C14  
 Wire Leads: 4.0 [101.6] Min., 18AWG, UL1015

## Case Dimensions

| Part No. | A<br>(max.)          | B<br>(max.)          | C<br>(max.)          | D<br>$\pm .015$<br>$\pm .38$ | E<br>(max.)          |
|----------|----------------------|----------------------|----------------------|------------------------------|----------------------|
| 15SRB1   | 1.75<br><i>44.45</i> | 1.13<br><i>28.70</i> | 0.96<br><i>24.38</i> | 1.58<br><i>40.00</i>         | 2.04<br><i>51.76</i> |
| 15SRB2   | 1.54<br><i>39.12</i> | 1.13<br><i>28.70</i> | 0.96<br><i>24.38</i> | 1.58<br><i>40.00</i>         | 2.04<br><i>51.76</i> |
| 15SRBP   | 1.54<br><i>39.12</i> | 1.13<br><i>28.70</i> | 0.96<br><i>24.38</i> | 1.58<br><i>40.00</i>         | 2.04<br><i>21.76</i> |
| 15SRBS1  | 1.75<br><i>44.45</i> | 1.13<br><i>28.70</i> | 0.96<br><i>24.38</i> | 1.19<br><i>30.10</i>         | 1.41<br><i>35.81</i> |
| 15SRB8   | 0.95<br><i>24.13</i> | 1.13<br><i>28.70</i> | 0.96<br><i>24.38</i> | 1.58<br><i>40.00</i>         | 2.04<br><i>51.76</i> |
| 15SRBS8  | .95<br><i>24.13</i>  | 1.13<br><i>28.70</i> | 0.96<br><i>24.38</i> | 1.19<br><i>30.10</i>         | 1.41<br><i>35.81</i> |
| 15SRBX8  | 0.95<br><i>24.1</i>  | 1.11<br><i>28.2</i>  | 0.89<br><i>22.61</i> | 1.35*<br><i>34.29*</i>       | 1.41<br><i>35.81</i> |
| 15SRBY8  | 0.95<br><i>24.1</i>  | 1.11<br><i>28.2</i>  | 0.89<br><i>22.61</i> | 1.30*<br><i>33.02*</i>       | 1.36<br><i>34.54</i> |

\*max.

Minimum Depth, Cost-effective Shielded Power Inlet Filter (continued)

# SRB Series

## Recommended Panel Cutouts

### SRB1, SRB2, SRBP & SRB8



Tolerances  $\pm .005$  [0.13] unless otherwise noted  
 Note 1: SRB1 and SRB8 can be front or back mounted  
 Note 2: SRB2 and SRBP can be back mounted only

### SRBS



| Panel Thickness             | G Dim. $\pm .002$ [.05] |
|-----------------------------|-------------------------|
| 0.031 - 0.052 [0.79 - 1.32] | 1.260 [32.00]           |
| 0.046 - 0.068 [1.17 - 1.73] | 1.350 [34.29]           |

### SRBX

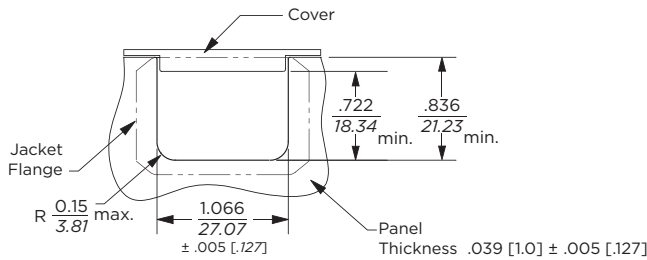

### SRBY



## PC Board Layout

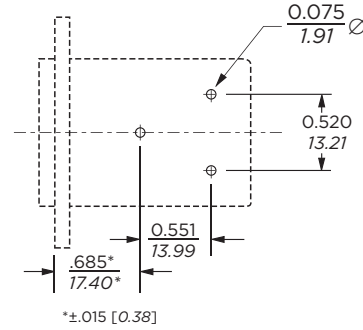

SRBX8



**Minimum Depth, Cost-effective Shielded Power Inlet Filter** *(continued)*

# SRB Series

## Performance Data

### Typical Insertion Loss

Measured in closed 50 Ohm system



### Minimum Insertion Loss

Measured in closed 50 Ohm system

Common Mode / Asymmetrical (Line to Ground)

| Current Rating | Frequency – MHz |    |    |    |     |     |
|----------------|-----------------|----|----|----|-----|-----|
|                | 1               | 5  | 10 | 50 | 100 | 300 |
| Q              | -               | -  | -  | -  | -   | 20  |
| R              | -               | -  | -  | 3  | 6   | 22  |
| S              | -               | -  | 1  | 6  | 17  | 19  |
| T              | -               | -  | 2  | 13 | 13  | 19  |
| W              | -               | 2  | 4  | 18 | 13  | 20  |
| X              | -               | 5  | 9  | 25 | 10  | 17  |
| Y              | 1               | 10 | 15 | 20 | 8   | 22  |
| Z              | 2               | 14 | 18 | 17 | 7   | 15  |

---

**Engineering Notes**

---



---

#### 4. DC Filters – Table of Contents

---

|                      |      |
|----------------------|------|
| Introduction .....   | .210 |
| Selector Chart ..... | .211 |
| DA Series .....      | .212 |
| DB Series .....      | .214 |
| DC Series .....      | .217 |
| P Series .....       | .223 |

**Introduction**

**STAY CONNECTED WITH CORCOM PRODUCTS**

TE Connectivity (TE) is a world leader in EMI-RFI filtering technology. Since 1955, TE has been providing EMI-RFI solutions to leading computer, industrial and telecommunications companies worldwide. Whether you are meeting FCC and international EMC standards on EMI-RFI emissions or developing a newly designed piece of equipment from being disturbed by EMI-RFI in the environment, a power line filter will help your equipment with compliance.

**This section highlights TE's product offering of DC rated products.** Whether the issues involve filtering noise on the data lines or on the power lines, TE can provide the needed solutions for both susceptibility and to help achieve system emissions and immunity compliance.

**As new technologies in the Telecom-Datacom industry are developed and introduced,** TE continues to design and develop new products to address the EMI-RFI filtering issues. TE's design engineers are very actively working with telecom and datacom system engineers to solve EMI-RFI issues.

**In working with two of the leading North American communications equipment companies,** TE engineers solved the EMI-RFI issues present by applying 48 VDC filters at the primary input of the DC power supply. One of the applications was on network routing equipment and required a two-stage 48VDC filter on the input to the DC power supply. TE applied high-frequency attenuating 48VDC filters on the load side of the DC power supplies to solve high-frequency EMI-RFI issues.



Typical Piece of Communications Equipment Utilizing 48VDC Filters

TE has provided solutions in both power line filtering and signal line filtering applications for many leading communications companies. As data transmission speeds increase and EMI-RFI issues multiply, TE has developed products to better solve the newer challenges communications companies encounter.

**Corcom DC power line and signal line filters have been included in:**

- Network routing equipment
- Servers
- Modems
- Switching equipment
- Wireless cabinets
- Ethernet hubs
- Base stations
- Repeater stations
- Power supplies for all types of communications equipment

**TE has developed DC filter products specifically for the communications industry including:**

- DC power line clean-up filters
- Medium and multiple-stage high-performance DC power line filters
- High frequency DC power line filters (up to 3GHz)
- High current DC power line filters (up to 60A)
- Data-transmission signal line filters

**Corcom DC filters are available in versions that can solve a wide variety of EMI-RFI issues.** TE has solved basic EMI-RFI issues with simple clean-up DC filters and has solved more complex EMI-RFI issues with mid-range and multiple-stage high performing DC filters. TE has also solved high-frequency noise problems (up to 3GHz) encountered with high-speed data transmission and switching power supplies.

**Selector Chart**



| Series                 | Input                            | Output                                 | Mounting                            | Options  | Current Rating           |
|------------------------|----------------------------------|--|-------------------------------------|--|--------------------------|
| <p><b>P</b></p>        | 2-pin Inlet                      | 1/4" Terminal                          | Snap In Panel<br>or<br>Flange Panel | Fuse   | 3, 6, 10A                |
| <p><b>DA / DAS</b></p> | 3-pin Inlet                      | 1/4" Terminal<br>or<br>PC Board        | Snap In Panel<br>or<br>Flange Panel | —  | 3, 6, 10,<br>15A         |
| <p><b>DB</b></p>       | 2-pin<br>High Current<br>Inlet   | Wire Leads                             | Flange Panel<br>and<br>Rear Mount   | Compact,<br>Standard,<br>Feedthrough<br>& Hi-Performance<br>Filters<br>and<br>Unfiltered Inlet &<br>Plug available<br>Separately | 60A                      |
| <p><b>DC</b></p>       | Redundant Stud<br>Terminal Block | Redundant Stud<br>or<br>Terminal Block | Bulkhead<br>or<br>Flange Chassis    | Circuit Breaker<br>and/or<br>High Frequency<br>Performance   | 15, 30, 60,<br>100, 125A |

**Compact RFI Line Filter with DC Inlet Connection**

# DA Series



UL Recognized  
CSA Certified  
TUV Certified

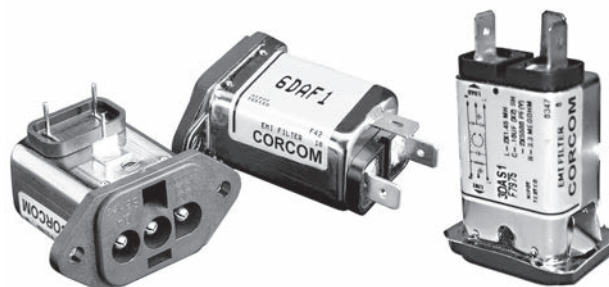

DAFP                      DAF1                      DAS1

## DA Series

- General purpose line filters for DC applications up to 125VDC.
- Compact with a 3-pin inlet connector
- Available in 3, 6, 10 and 15A versions
- Flange mount with 1/4" or PCB terminals
- Mates with a standard MOLEX\* connector (HCS Series)

## Ordering Information

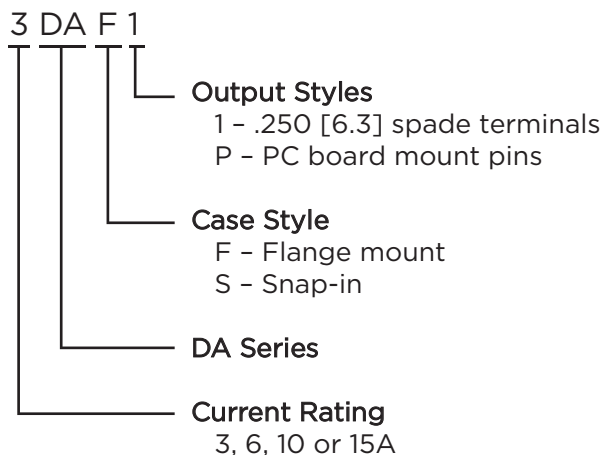

## Available Part Numbers

|       |        |
|-------|--------|
| 3DAF1 | 10DAF1 |
| 3DAS1 | 10DAS1 |
| 3DAFP | 10DAFP |
| 6DAF1 | 15DAF1 |
| 6DAS1 | 15DAS1 |
| 6DAFP | 15DAFP |

## Specifications

- Hipot rating (one minute):**  
Line to Ground: 2250 VDC  
Line to Line: 1450 VDC
- Rated Voltage (max):** 125 VDC
- Rated Current:** 3 to 15A
- Operating Ambient Temperature Range (at rated current  $I_r$ ):** -10°C to +55°C  
In an ambient temperature ( $T_a$ ) higher than +55°C the maximum operating current ( $I_o$ ) is calculated as follows:  $I_o = I_r \sqrt{(85-T_a)/45}$

## Electrical Schematic

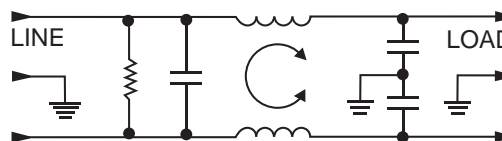

## Accessories



**GA310** - (shown above) Pre-assembled connector housing and terminals with three 36" long 18 gauge wires to mate with DA Series filters

### MOLEX\* connector part numbers:

- 03-12-1036 Connector housing for DA Series  
18-12-1222 Female terminals (3 per connector)

\*MOLEX is a trademark of MOLEX Incorporated

**Compact RFI Line Filter with DC Inlet Connection** *(continued)*

# DA Series

## Case Styles

### DAF1



Typical Dimensions:

Load Terminals (2): .250 [6.3] with .07 [1.8] Dia. hole  
 Ground Terminal (1): .250 [6.3] with .07 x .16 [1.8 x 3.8] slot  
 Mounting Holes (2): .187 ± .008 [4.75 ± .20] Dia.  
 90° countersunk for # 4 flathead screw

### DAS1



Typical Dimensions:

Load Terminals (2): .250 [6.3] with .07 [1.8] Dia. hole  
 Ground Terminal (1): .250 [6.3] with .07 x .16 [1.8 x 3.8] slot

### DAFP



Typical Dimensions:

Pins (3): .031 x .06 ± .003  
 Mounting Holes (2): 0.187 ± .008 [4.75 ± .20] Dia.  
 90° countersunk for # 4 flathead screw

## PC Board Layout



## Case Dimensions

| Part No. | A<br>(max.)          | B<br>(max.)          | C<br>(max.)          | D<br>$\pm .010$<br>$\pm .25$ | E<br>(max.)          |
|----------|----------------------|----------------------|----------------------|------------------------------|----------------------|
| DAF1     | <b>2.15</b><br>54.61 | <b>1.12</b><br>28.45 | <b>0.81</b><br>20.57 | <b>1.575</b><br>40.01        | <b>1.98</b><br>50.29 |
| DAS1     | <b>1.98</b><br>50.29 | <b>1.10</b><br>27.94 | <b>0.81</b><br>20.57 | <b>0.96*</b><br>24.38        | <b>1.41</b><br>35.81 |
| DAFP     | <b>1.54</b><br>39.12 | <b>1.12</b><br>28.45 | <b>0.81</b><br>20.57 | <b>1.575</b><br>40.01        | <b>1.98</b><br>50.29 |

\*Represents max. dimension

## Recommended Panel Cutouts

### DAF



### DAS



## Performance Data

### Minimum Insertion Loss

Measured in closed 50 Ohm system

Common Mode / Asymmetrical (Line to Ground)

| Current Rating | Frequency – MHz |    |     |    |    |    |    |    |    |         |
|----------------|-----------------|----|-----|----|----|----|----|----|----|---------|
|                | .05             | .1 | .15 | .5 | 1  | 3  | 5  | 10 | 30 | 100 200 |
| 3A             | 6               | 9  | 11  | 26 | 41 | 48 | 52 | 55 | 46 | 22 16   |
| 6A             | 2               | 4  | 6   | 18 | 30 | 37 | 42 | 48 | 42 | - -     |
| 10A            | -               | 1  | 4   | 8  | 17 | 25 | 30 | 36 | 38 | 21 11   |
| 15A            | -               | -  | -   | 3  | 5  | 13 | 19 | 25 | 29 | 10 14   |

Differential Mode / Symmetrical (Line to Line)

| Current Rating | Frequency – MHz |    |     |    |    |    |    |    |    |         |
|----------------|-----------------|----|-----|----|----|----|----|----|----|---------|
|                | .05             | .1 | .15 | .5 | 1  | 3  | 5  | 10 | 30 | 100 200 |
| 3A             | -               | 4  | 7   | 16 | 18 | 37 | 47 | 50 | 43 | 31 36   |
| 6A             | -               | 4  | 7   | 19 | 21 | 27 | 40 | 53 | 41 | - -     |
| 10A            | 2               | 4  | 6   | 17 | 22 | 23 | 32 | 48 | 38 | 30 26   |
| 15A            | -               | -  | 2   | 17 | 19 | 29 | 33 | 37 | 37 | 31 28   |

**Compact RFI High Current DC Inlet Connection**

# DB Series



UL Recognized  
CSA Certified  
TUV Certified

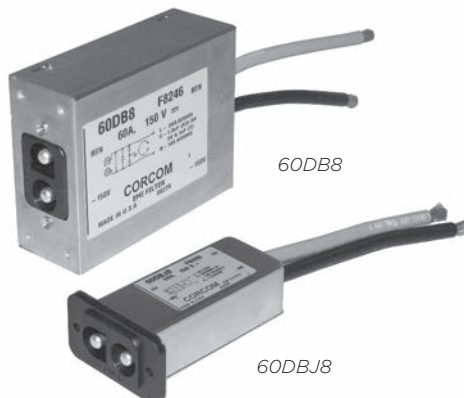

## DB Series

- Compact connector for high-current DC applications
- Reliable performance in a compact assembly
- Polarized mating scheme
- Easy customer termination of power source
- Plug and receptacle available pre-terminated in standard wire lengths
- Available filtered or unfiltered

## Ordering Information

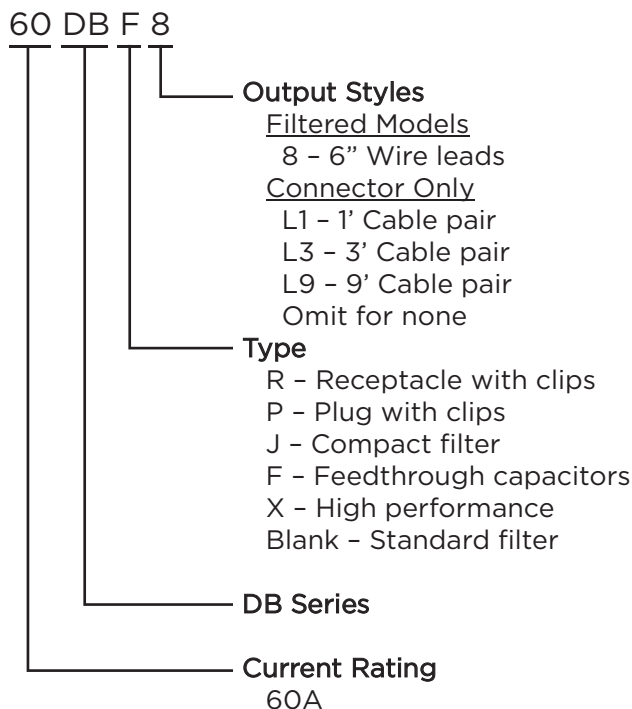

## Specifications

**Hipot rating (one minute):**

|                 | Filtered Models | DBR & DBP |
|-----------------|-----------------|-----------|
| Line to Ground: | 2121 VDC        | n/a       |
| LIne to Line:   | 1768 VDC        | 1600 VAC  |

**Rated Voltage (max):** 150VDC\* 300 VDC

**Rated Current:** 60A (all versions)

**Operating Ambient Temperature Range (at rated current I<sub>r</sub>):** -10°C to +55°C  
 In an ambient temperature (T<sub>a</sub>) higher than +55°C the maximum operating current (I<sub>O</sub>) is calculated as follows:  $I_O = I_r \sqrt{(85-T_a)/30}$

\*Certified to 120V for TUV

## Available Part Numbers

| Filtered Models |        |
|-----------------|--------|
| 60DB8           | 60DBJ8 |
| 60DBF8          | 60DBX8 |

| Connectors Only |         |
|-----------------|---------|
| 60DBR           | 60DBP   |
| 60DBRL1         | 60DBPL1 |
| 60DBRL3         | 60DBPL3 |
|                 | 60DBPL9 |

**WARNING**  
This is not approved for hot swap or current interruption in DC applications. Doing so will result in irreparable damage to contacts.



Compact RFI High Current DC Inlet Filter (continued)

# DB Series

## Electrical Schematics

### DB8 & DBJ8



### DBF8



### DBX8



60DBPL

60DBRL

Available as connector only (shown)  
or with pre-installed 6AWG 300V Extra Flexible wire

## Case Styles

### DBJ8



### DB8 & DBF8



### DBX8



4  
DC Filters

**Compact RFI High Current DC Inlet Filter** *(continued)*

# DB Series

## Case Styles *(continued)*

### DBPL



### DBRL



## Recommended Panel Cutout



Minimum cable lengths:

|                |                |
|----------------|----------------|
| DBRL1 / DBPL1: | 12 [ 304.8 ]   |
| DBRL3 / DBPL3: | 36 [ 914.4 ]   |
| DBPL9:         | 108 [ 2743.2 ] |

## Accessories / Tooling

|   |              |
|---|--------------|
| Insertion/Extraction Tool:                  | 1643922-1*   |
| Crimp per TE spec:                          | 114-13206    |
| Crimp tool:                                 | M22520/23-01 |
| Indenter head:                              | M22520/23-04 |
| Locator:                                    | M22520/23-11 |
| Connector system locking kit <sup>1</sup> : | Contact TE   |

\*for DBR / DBP Only

<sup>1</sup>Tool required to disengage mated connector when using locking kit

## Case Dimensions

| Part No. | A             | B             | C                         | D                         | E                         | F                         |
|----------|---------------|---------------|---------------------------|---------------------------|---------------------------|---------------------------|
|          | (max)         | (max)         | $\frac{\pm.025}{\pm.635}$ | $\frac{\pm.025}{\pm.635}$ | $\frac{\pm.025}{\pm.635}$ | $\frac{\pm.025}{\pm.635}$ |
| 60DBJ8   | <b>3.2</b>    | <b>1.36</b>   | <b>1.181</b>              | <b>1.654</b>              | <b>2.087</b>              | <b>1.28</b>               |
| 60DB8    | <b>4.06</b>   | <b>3.20</b>   | <b>1.45</b>               | <b>2.50</b>               | <b>0.875</b>              | <b>2.077</b>              |
| 60DBF8   | <i>103.12</i> | <i>81.28</i>  | <i>36.83</i>              | <i>63.50</i>              | <i>22.23</i>              | <i>52.76</i>              |
| 60DBX    | <b>6.06</b>   | <b>3.50</b>   | <b>1.45</b>               | <b>2.876</b>              | <b>0.875</b>              | <b>2.265</b>              |
| 60DBRL   | <b>1.22*</b>  | <b>1.181*</b> | <b>2.087</b>              | <b>1.654</b>              | <b>1.023</b>              | <b>0.591</b>              |
| 60DBPL   | <b>1.695*</b> | <b>0.93*</b>  | <b>2.08</b>               | <b>1.654</b>              | <b>1.195</b>              | <b>0.465</b>              |

\*± 0.025 [0.635]

## Performance Data

### Minimum Insertion Loss

Measured in closed 50 Ohm system

Common Mode / Asymmetrical (Line to Ground)

| Part No. | Frequency – MHz |      |     |   |    |    |    |    |    |     |
|----------|-----------------|------|-----|---|----|----|----|----|----|-----|
|          | 0.1             | 0.15 | 0.5 | 1 | 5  | 1  | 20 | 30 | 50 | 100 |
| 60DBJ8   | -               | -    | -   | 1 | 13 | 21 | 30 | 40 | 30 | 20  |

| Part No. | Frequency – MHz |     |      |    |    |    |    |    |    |    |
|----------|-----------------|-----|------|----|----|----|----|----|----|----|
|          | 0.05            | 0.1 | 0.15 | .5 | 1  | 3  | 5  | 10 | 20 | 30 |
| 60DB8    | 2               | 7   | 10   | 23 | 30 | 48 | 38 | 28 | 20 | 16 |
| 60DBF8   | 15              | 22  | 25   | 35 | 42 | 50 | 58 | 54 | 38 | 36 |
| 60DBX8   | -               | 10  | 16   | 40 | 48 | 54 | 60 | 51 | 40 | 36 |

Differential Mode / Symmetrical (Line to Line)

| Part No. | Frequency – MHz |      |     |    |    |    |    |    |    |     |
|----------|-----------------|------|-----|----|----|----|----|----|----|-----|
|          | 0.1             | 0.15 | 0.5 | 1  | 5  | 1  | 20 | 30 | 50 | 100 |
| 60DBJ8   | 5               | 8    | 19  | 26 | 34 | 26 | 20 | 16 | -  | -   |

| Part No. | Frequency – MHz |     |      |    |    |    |    |    |    |    |
|----------|-----------------|-----|------|----|----|----|----|----|----|----|
|          | 0.05            | 0.1 | 0.15 | .5 | 1  | 3  | 5  | 10 | 20 | 30 |
| 60DB8    | 20              | 26  | 29   | 43 | 53 | 30 | 30 | 24 | 20 | 18 |
| 60DBF8   | 9               | 15  | 18   | 30 | 34 | 40 | 44 | 44 | 48 | 52 |
| 60DBX8   | 31              | 30  | 30   | 70 | 70 | 54 | 50 | 60 | 54 | 50 |

**RFI Power Line Filters for DC Applications**

# DC Series



UL Recognized  
CSA Certified  
TUV Certified



60DCF6B



15DCF10

## DC Series

- General purpose line filters for DC applications up to 125VDC
- Available with or without a circuit breaker
- Available with feedthrough capacitors for added high frequency performance
- Available in both flange mound (DCF) and bulkhead mount (DCB) configuration

## Ordering Information

60 DC B 6 B

### Options

- B - Circuit breaker
  - F - Feedthrough capacitors
  - BF - Circuit breaker and feedthrough
- F and BF available only in bulkhead (B) mounting style*
- Omit for none

### Input / Output Styles

- 6 - Redundant stud
- 10 - Phoenix terminal

### Mounting Style

- F = Flange
  - B = Bulkhead and rack
- Required for F or BF options*

### DC Series

- Current Rating
- 15, 30, 60, 100 or 125A

## Specifications

### Hipot rating (one minute):

|                 |          |
|-----------------|----------|
| Line to Ground: | 2250 VDC |
| Line to Line:   | 1450 VDC |

### Rated Voltage (max):

80 VDC

### Rated Current:

15 to 125A

### Operating Ambient Temperature Range

(at rated current  $I_r$ ): -10°C to +55°C

In an ambient temperature ( $T_a$ ) higher than +55°C the maximum operating current ( $I_o$ ) is calculated as follows:  $I_o = I_r \sqrt{(85-T_a)/30}$

## Electrical Schematics

### Standard Performance



### High Frequency Performance (F & BF Styles)

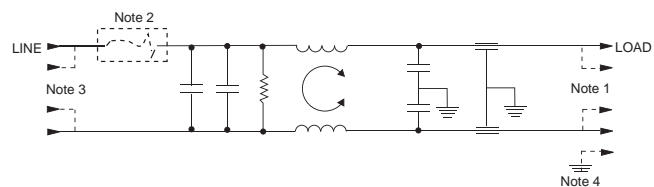

- Note 1: Depicts redundant style 6 terminals.
- Note 2: Depicts optional circuit breaker.
- Note 3: For 100 & 125A versions delete second coil.
- Note 4: Depicts style 10 terminal versions which have separate ground stud.

**RFI Power Line Filters for DC Applications** *(continued)*

# DC Series

## Available Part Numbers

| Standard Performance |           | High Performance |          |
|----------------------|-----------|------------------|----------|
| 15DCF6               | 15DCF10   | 15DCB10F         | 15DCB6F  |
| 30DCF6               | 30DCF10   | 30DCB10F         | 30DCB6F  |
| 60DCF6               | 60DCF10   | 60DCB10F         | 60DCB6F  |
| 100DCF6              | 100DCF10  | 100DCB10F        | 100DCB6F |
| 125DCF6              | 125DCF10  | 125DCB10F        | 125DCB6F |
| 15DCF6B              | 15DCF10B  | 15DCB6BF         |          |
| 30DCF6B              | 30DCF10B  | 30DCB6BF         |          |
| 60DCF6B              | 60DCF10B  | 60DCB6BF         |          |
| 100DCF6B             | 100DCF10B | 100DCB6BF        |          |
| 125DCF6B             | 125DCF10B | 125DCB6BF        |          |
| 15DCB6               | 15DCB10   | 15DCB10BF        |          |
| 30DCB6               | 30DCB10   | 30DCB10BF        |          |
| 60DCB6               | 60DCB10   | 60DCB10BF        |          |
| 100DCB6              | 100DCB10  | 100DCB10BF       |          |
| 125DCB6              | 125DCB10  | 125DCB10BF       |          |
| 15DCB6B              | 15DCB10B  |                  |          |
| 30DCB6B              | 30DCB10B  |                  |          |
| 60DCB6B              | 60DCB10B  |                  |          |
| 100DCB6B             | 100DCB10B |                  |          |
| 125DCB6B             | 125DCB10B |                  |          |

## Termination Options

### Style 6 (15, 30 & 60A)

- Supplied with #10-32 redundant studs
- 0.625 [*15.88*] spacing like polarity
- 0.750 [*19.05*] spacing opposing polarity
- Torque specification: 27 ±3 in-lb.

### Style 10 (15 & 30A)

- PHOENIX CONTACT\* part number: VDFK4
- Accepts 12 AWG stranded wire
- Wire strip length: 0.315 [*8.0*]
- Torque specification: 5.5 – 7.0 in-lb.
- Ground stud: 8-32

### Style 10 (100A)

- PHOENIX CONTACT\* part number: HDFK 25-VP
- Accepts 4 AWG stranded wire
- Wire strip length: 0.748 [*19.0*]
- Torque specification: 35.4 – 39.9 in-lb.
- Ground stud: 1/4-20

### Style 6 (100 & 125A)

- Supplied with 1/4-20 redundant studs
- 0.750 [*19.05*] spacing like polarity
- 1.00 [*25.4*] spacing opposing polarity
- Torque specification: 45 ±2 in-lb

### Style 10 (60A)

- PHOENIX CONTACT\* part number: HDFK 16-VP
- Accepts 6 AWG stranded wire
- Wire strip length: 0.630 [*16.0*]
- Torque specification: 17.7 – 21.2 in-lb.
- Ground stud: 10-32

### Style 10 (125A)

- PHOENIX CONTACT\* part number: HDFK 50-VP
- Accepts 1 AWG stranded wire
- Wire strip length: 0.945 [*24.0*]
- Torque specification: 35.4 – 39.9 in-lb.
- Ground stud: 1/4-20

\*PHOENIX CONTACT is a trademark of Phoenix Contact GmbH & Co. KG.

**RFI Power Line Filters for DC Applications** *(continued)*

# DC Series

## Recommended Panel Cutouts

### DCB6(F) & DCB10(F)



### DCB6B(F) & DCB10B(F) 15 to 60A



### DCB6B(F) & DCB10B(F) 100 to 125A



## Cutout Dimensions

### DCB6(F) & DCB10(F)

| Part No.    | A            | B            | C            |
|-------------|--------------|--------------|--------------|
| 15DCB6(F)   | <b>1.375</b> | <b>1.249</b> | <b>3.472</b> |
| 30DCB6(F)   | 34.93        | 31.72        | 88.19        |
| 15DCB10(F)  | <b>1.250</b> | <b>1.000</b> | <b>3.472</b> |
| 30DCB10(F)  | 31.75        | 25.40        | 88.19        |
| 60DCB6(F)   | <b>1.375</b> | <b>1.249</b> | <b>3.472</b> |
|             | 34.93        | 31.72        | 88.19        |
| 60DCB10(F)  | <b>1.674</b> | <b>1.010</b> | <b>3.443</b> |
|             | 42.52        | 25.65        | 87.45        |
| 100DCB6(F)  | <b>1.700</b> | <b>1.549</b> | <b>3.472</b> |
| 125DCB6(F)  | 43.18        | 39.34        | 88.19        |
| 100DCB10(F) | <b>1.954</b> | <b>1.500</b> | <b>2.830</b> |
|             | 49.63        | 38.10        | 71.20        |
| 125DCB10(F) | <b>2.250</b> | <b>1.590</b> | <b>2.725</b> |
|             | 57.15        | 40.39        | 69.22        |

### DCB6B(F) & DCB10B(F) 15 to 60A

| Part No.    | A           | B            | C            | D            | E            | F            |
|-------------|-------------|--------------|--------------|--------------|--------------|--------------|
| 15DCB6B(F)  | <b>1.50</b> | <b>0.781</b> | <b>1.308</b> | <b>3.472</b> | <b>1.375</b> | <b>1.249</b> |
| 15DCF6B     | 38.10       | 19.84        | 33.22        | 88.19        | 34.93        | 31.72        |
| 15DCB10B(F) | <b>1.50</b> | <b>0.781</b> | <b>1.308</b> | <b>3.472</b> | <b>1.250</b> | <b>1.00</b>  |
| 15DCF10B    | 38.10       | 19.84        | 33.22        | 88.19        | 31.75        | 25.40        |
| 30DCB6B(F)  | <b>1.50</b> | <b>0.781</b> | <b>1.308</b> | <b>3.472</b> | <b>1.375</b> | <b>1.249</b> |
| 30DCF6B     | 38.10       | 19.84        | 33.22        | 88.19        | 34.93        | 31.72        |
| 30DCB10B(F) | <b>1.50</b> | <b>0.781</b> | <b>1.308</b> | <b>3.472</b> | <b>1.250</b> | <b>1.00</b>  |
| 30DCF10B    | 38.10       | 19.84        | 33.22        | 88.19        | 31.75        | 25.40        |
| 60DCB10B(F) | <b>1.50</b> | <b>0.781</b> | <b>1.308</b> | <b>3.443</b> | <b>1.674</b> | <b>1.010</b> |
| 60DCF10B    | 38.10       | 19.84        | 33.22        | 87.45        | 42.52        | 25.65        |
| 60DCF6B(F)  | <b>1.50</b> | <b>0.781</b> | <b>1.308</b> | <b>3.472</b> | <b>1.375</b> | <b>1.249</b> |
| 60DCF6B     | 38.10       | 19.84        | 33.22        | 88.19        | 34.93        | 31.72        |

### DCB6B(F) & DCB10B(F) 100 to 125A

| Part No.     | A            | B            | C            |
|--------------|--------------|--------------|--------------|
| 100DCB6B(F)  | <b>1.70</b>  | <b>1.549</b> | <b>4.222</b> |
| 100DCF6B     |              |              |              |
| 125DCB6B(F)  | 43.18        | 39.34        | 107.23       |
| 125DCF6B     |              |              |              |
| 100DCB10B(F) | <b>1.954</b> | <b>1.50</b>  | <b>4.295</b> |
| 100DCF10B    | 49.63        | 38.10        | 109.09       |
| 125DCB10B(F) | <b>2.25</b>  | <b>1.59</b>  | <b>4.147</b> |
|              | 57.15        | 40.39        | 105.33       |
| 125DCF10B    | <b>2.25</b>  | <b>1.59</b>  | <b>2.725</b> |
|              | 57.15        | 40.39        | 105.33       |

RFI Power Line Filters for DC Applications *(continued)*

# DC Series

## Case Styles

### DCB6 & DCB6B



### DCB10 & DCB10B (60 to 125A)



### DCF6

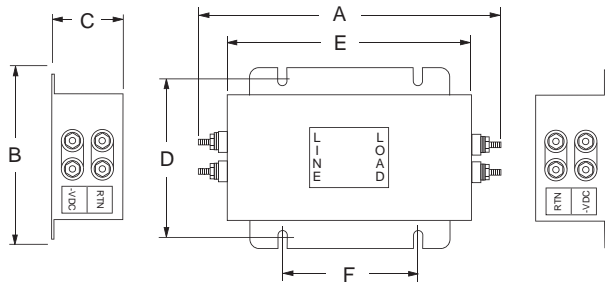

Typical Dimensions:  
Mounting Slots (4): .260 x .39 [6.6 x 9.9] 60 to 125A versions  
Mounting Holes (4): .203 x .156 [5.2 x 4.0] 15 & 30A versions

### DCF10 (15 & 30A)

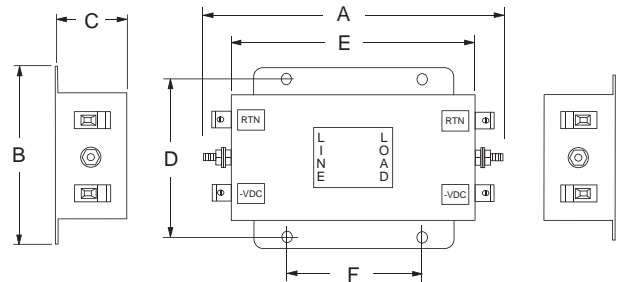

Typical Dimensions:  
Mounting Holes (4): .203 x .156 [5.2 x 4.0]

### DCF6B

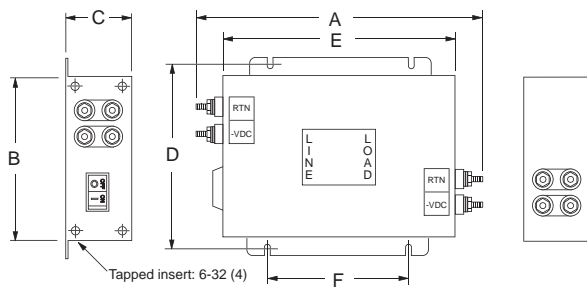

Typical Dimensions:  
Mounting Slots (4): .260 x .39 [6.6 x 9.9]

### DCF10 (60 to 125A)

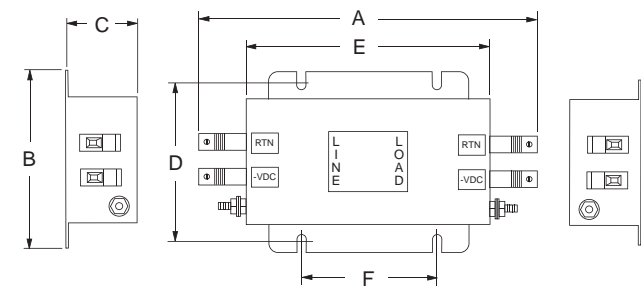

Typical Dimensions:  
Mounting Slots (4): .260 x .39 [6.6 x 9.9]

### DCB10 & DCB10B (15 to 30A)

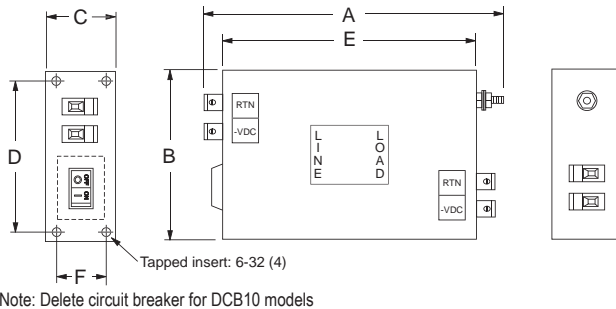

### DCF10B (15 & 30A)

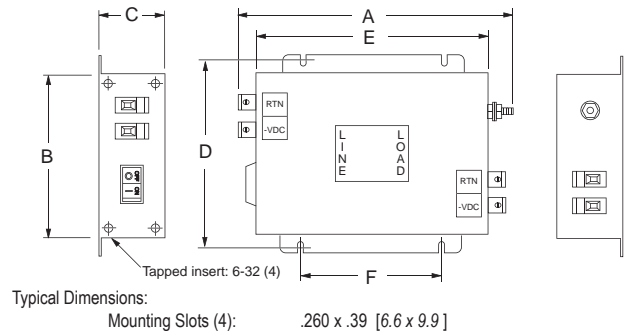

RFI Power Line Filters for DC Applications *(continued)*

# DC Series

## Case Styles *(continued)*

### DCF10B (60 TO 125A)



Typical Dimensions:  
Mounting Slots (4): .260 x .39 [6.6 x 9.9]

## Case Dimensions

| Part No.    | A<br>(max)  | B<br>(max)  | C<br>(max)  | D<br>$\pm 0.20$<br>$\pm .51$ | E<br>(max)  | F<br>$\pm 0.20$<br>$\pm .51$ |
|-------------|-------------|-------------|-------------|------------------------------|-------------|------------------------------|
| 15DCB6(F)   | <b>5.69</b> | <b>5.06</b> | <b>1.48</b> | <b>4.50</b>                  | <b>4.06</b> | <b>0.950</b>                 |
| 15DCB6B(F)  | <b>7.69</b> | <b>5.06</b> | <b>1.48</b> | <b>4.50</b>                  | <b>6.06</b> | <b>0.950</b>                 |
| 15DCB10(F)  | <b>5.06</b> | <b>5.06</b> | <b>1.48</b> | <b>4.50</b>                  | <b>4.06</b> | <b>0.950</b>                 |
| 15DCB10B(F) | <b>7.06</b> | <b>5.06</b> | <b>1.48</b> | <b>4.50</b>                  | <b>6.06</b> | <b>0.950</b>                 |
| 15DCF6      | <b>5.33</b> | <b>3.10</b> | <b>1.78</b> | <b>2.677</b>                 | <b>3.70</b> | <b>2.00</b>                  |
| 15DCF6B(F)  | <b>7.69</b> | <b>5.06</b> | <b>1.48</b> | <b>5.740</b>                 | <b>6.06</b> | <b>3.52</b>                  |
| 15DCF10     | <b>4.75</b> | <b>3.10</b> | <b>1.78</b> | <b>2.677</b>                 | <b>3.70</b> | <b>2.0</b>                   |
| 15DCF10B(F) | <b>7.06</b> | <b>5.06</b> | <b>1.48</b> | <b>5.740</b>                 | <b>6.06</b> | <b>3.520</b>                 |
| 30DCB6(F)   | <b>7.69</b> | <b>5.06</b> | <b>1.48</b> | <b>4.50</b>                  | <b>6.06</b> | <b>0.95</b>                  |
| 30DCB6B(F)  | <b>8.69</b> | <b>5.06</b> | <b>1.48</b> | <b>4.50</b>                  | <b>7.06</b> | <b>0.95</b>                  |
| 30DCB10(F)  | <b>7.06</b> | <b>5.06</b> | <b>1.48</b> | <b>4.50</b>                  | <b>6.06</b> | <b>0.95</b>                  |
| 30DCB10B(F) | <b>8.06</b> | <b>5.06</b> | <b>1.48</b> | <b>4.50</b>                  | <b>7.06</b> | <b>0.95</b>                  |
| 30DCF6      | <b>6.19</b> | <b>3.96</b> | <b>2.18</b> | <b>3.50</b>                  | <b>4.56</b> | <b>2.00</b>                  |
| 30DCF6B     | <b>8.69</b> | <b>5.0</b>  | <b>1.48</b> | <b>5.74</b>                  | <b>7.06</b> | <b>4.52</b>                  |
| 30DCF10     | <b>5.56</b> | <b>3.96</b> | <b>2.18</b> | <b>3.5</b>                   | <b>4.56</b> | <b>2.0</b>                   |
| 30DCF10B    | <b>8.06</b> | <b>5.06</b> | <b>1.48</b> | <b>5.74</b>                  | <b>7.06</b> | <b>4.52</b>                  |

## Case Dimensions *(continued)*

| Part No.     | A<br>(max)   | B<br>(max)  | C<br>(max)  | D<br>$\pm 0.20$<br>$\pm .51$ | E<br>(max)   | F<br>$\pm 0.20$<br>$\pm .51$ |
|--------------|--------------|-------------|-------------|------------------------------|--------------|------------------------------|
| 60DCB6(F)    | <b>8.69</b>  | <b>5.06</b> | <b>1.48</b> | <b>4.50</b>                  | <b>7.06</b>  | <b>0.95</b>                  |
| 60DCB6B(F)   | <b>10.69</b> | <b>5.06</b> | <b>1.48</b> | <b>4.50</b>                  | <b>9.06</b>  | <b>0.95</b>                  |
| 60DCF6       | <b>7.56</b>  | <b>5.48</b> | <b>2.55</b> | <b>4.92</b>                  | <b>5.94</b>  | <b>2.756</b>                 |
| 60DCF6B      | <b>10.69</b> | <b>5.06</b> | <b>1.48</b> | <b>5.74</b>                  | <b>9.06</b>  | <b>6.52</b>                  |
| 60DCF10      | <b>8.56</b>  | <b>5.48</b> | <b>2.55</b> | <b>4.92</b>                  | <b>5.94</b>  | <b>2.576</b>                 |
| 60DCF10B     | <b>11.75</b> | <b>5.06</b> | <b>1.48</b> | <b>5.74</b>                  | <b>9.06</b>  | <b>6.52</b>                  |
| 100DCB6(F)   | <b>10.31</b> | <b>5.06</b> | <b>1.78</b> | <b>4.50</b>                  | <b>8.06</b>  | <b>1.25</b>                  |
| 100DCB6B(F)  | <b>12.31</b> | <b>6.06</b> | <b>1.78</b> | <b>5.50</b>                  | <b>10.06</b> | <b>1.25</b>                  |
| 100DCB10(F)  | <b>11.13</b> | <b>5.06</b> | <b>1.78</b> | <b>4.50</b>                  | <b>8.06</b>  | <b>1.25</b>                  |
| 100DCB10B(F) | <b>13.13</b> | <b>6.06</b> | <b>1.78</b> | <b>5.50</b>                  | <b>10.06</b> | <b>1.25</b>                  |
| 100DCF6      | <b>10.60</b> | <b>6.30</b> | <b>2.52</b> | <b>5.70</b>                  | <b>8.46</b>  | <b>4.52</b>                  |
| 100DCF6B     | <b>12.31</b> | <b>6.06</b> | <b>1.78</b> | <b>6.74</b>                  | <b>10.06</b> | <b>7.52</b>                  |
| 100DCF10     | <b>11.50</b> | <b>6.30</b> | <b>2.52</b> | <b>5.70</b>                  | <b>8.46</b>  | <b>4.52</b>                  |
| 100DCF10B    | <b>13.13</b> | <b>6.06</b> | <b>1.78</b> | <b>6.74</b>                  | <b>10.06</b> | <b>7.52</b>                  |
| 125DCB6(F)   | <b>10.31</b> | <b>5.06</b> | <b>1.78</b> | <b>4.50</b>                  | <b>8.06</b>  | <b>1.25</b>                  |
| 125DCB6B(F)  | <b>12.31</b> | <b>6.06</b> | <b>1.78</b> | <b>5.50</b>                  | <b>10.06</b> | <b>1.25</b>                  |
| 125DCB10(F)  | <b>11.50</b> | <b>5.06</b> | <b>1.78</b> | <b>4.50</b>                  | <b>8.06</b>  | <b>1.25</b>                  |
| 125DCB10B(F) | <b>13.50</b> | <b>6.06</b> | <b>1.78</b> | <b>5.50</b>                  | <b>10.06</b> | <b>1.25</b>                  |
| 125DCF6      | <b>10.60</b> | <b>6.30</b> | <b>2.52</b> | <b>5.70</b>                  | <b>8.46</b>  | <b>4.52</b>                  |
| 125DCF6B     | <b>12.31</b> | <b>6.06</b> | <b>1.78</b> | <b>6.74</b>                  | <b>10.06</b> | <b>7.52</b>                  |
| 125DCF10     | <b>11.86</b> | <b>6.30</b> | <b>2.52</b> | <b>5.70</b>                  | <b>8.46</b>  | <b>4.52</b>                  |
| 125DCF10B    | <b>13.50</b> | <b>6.06</b> | <b>1.78</b> | <b>6.74</b>                  | <b>10.06</b> | <b>7.52</b>                  |

4  
DC Filters

Dimensions are in inches and millimeters unless otherwise specified. Values in italics are metric equivalents. Dimensions are shown for reference purposes only. Specifications subject to change.

For email, phone or live chat, please go to [te.com/help](http://te.com/help)  
[corcom.com](http://corcom.com)

**RFI Power Line Filters for DC Applications** *(continued)*

# DC Series

## Performance Data *(continued)*

### Minimum Insertion Loss

Measured in closed 50 Ohm system

### Standard Performance

Common Mode / Asymmetrical (Line to Ground)

| Current Rating | Frequency – MHz |     |    |     |    |    |    |    |    |    |
|----------------|-----------------|-----|----|-----|----|----|----|----|----|----|
|                | .01             | .05 | .1 | .15 | .5 | 1  | 3  | 5  | 10 | 30 |
| 15A            | -               | 1   | 12 | 20  | 41 | 45 | 61 | 63 | 47 | 39 |
| 30A            | -               | 4   | 15 | 23  | 47 | 59 | 64 | 56 | 44 | 36 |
| 60A            | -               | -   | 9  | 17  | 38 | 40 | 59 | 50 | 39 | 34 |
| 100A           | -               | -   | 10 | 18  | 38 | 39 | 53 | 50 | 35 | 21 |
| 125A           | -               | -   | 12 | 18  | 30 | 32 | 44 | 49 | 29 | 18 |

Differential Mode / Symmetrical (Line to Line)

| Current Rating | Frequency – MHz |     |    |     |    |    |    |    |    |    |
|----------------|-----------------|-----|----|-----|----|----|----|----|----|----|
|                | .01             | .05 | .1 | .15 | .5 | 1  | 3  | 5  | 10 | 30 |
| 15A            | 7               | 22  | 27 | 30  | 30 | 36 | 56 | 49 | 38 | 31 |
| 30A            | 7               | 22  | 28 | 31  | 32 | 59 | 56 | 51 | 41 | 28 |
| 60A            | 15              | 30  | 36 | 40  | 40 | 35 | 60 | 51 | 39 | 32 |
| 100A           | 14              | 29  | 35 | 39  | 33 | 30 | 53 | 53 | 41 | 30 |
| 125A           | 14              | 24  | 35 | 39  | 40 | 28 | 53 | 60 | 42 | 33 |

### High Frequency Performance (F & BF Styles)

Common Mode / Asymmetrical (Line to Ground)

| Current Rating | Frequency – MHz |     |    |     |    |    |    |    |    |    |     |      |
|----------------|-----------------|-----|----|-----|----|----|----|----|----|----|-----|------|
|                | .01             | .05 | .1 | .15 | .5 | 1  | 3  | 5  | 10 | 20 | 300 | 3000 |
| 15A            | -               | 1   | 12 | 20  | 41 | 45 | 55 | 50 | 45 | 25 | 50  | 30   |
| 30A            | -               | 4   | 15 | 20  | 46 | 58 | 60 | 60 | 48 | 35 | 50  | 30   |
| 60A            | -               | -   | 9  | 16  | 38 | 42 | 52 | 60 | 48 | 26 | 40  | 30   |
| 100A           | -               | -   | 9  | 16  | 38 | 42 | 52 | 60 | 42 | 26 | 40  | 30   |
| 125A           | -               | -   | 9  | 16  | 28 | 34 | 46 | 54 | 34 | 34 | 40  | 30   |

Differential Mode / Symmetrical (Line to Line)

| Current Rating | Frequency – MHz |     |    |     |    |    |    |    |    |    |
|----------------|-----------------|-----|----|-----|----|----|----|----|----|----|
|                | .01             | .05 | .1 | .15 | .5 | 1  | 3  | 5  | 10 | 20 |
| 15A            | 7               | 22  | 27 | 30  | 30 | 50 | 60 | 60 | 60 | 36 |
| 30A            | 7               | 22  | 27 | 30  | 33 | 56 | 60 | 60 | 60 | 40 |
| 60A            | 15              | 30  | 36 | 40  | 37 | 26 | 46 | 54 | 48 | 30 |
| 100A           | 14              | 29  | 35 | 39  | 33 | 30 | 56 | 53 | 41 | 30 |
| 125A           | 14              | 29  | 35 | 39  | 40 | 28 | 53 | 60 | 42 | 33 |



The CHAMELEON Adaptable Module for DC Applications

# P Series



UL Recognized  
CSA Certified  
TUV Certified



## P Series

- Full flexibility of design in the most compact package
- General purpose designed for DC applications
- Mates with a standard MOLEX\* connector (HCS Series) which prevents accidental connection to AC Power

## Ordering Information

PS000DD3D



## Specifications

|  |                                       |
|--|---------------------------------------|
| <b>Hipot rating (one minute):</b>  |                                       |
| Line to Ground:  | 2250 VDC                              |
| Line to Line:  | 1450 VDC                              |
| <b>Rated Voltage (max):</b>  | 80 VDC                                |
| <b>Rated Current:</b>  | 3 to 10A                              |
| <b>Fuseholder*:</b>  | .25 x 1.25" or<br>5 x 20 mm           |
| <b>Terminals:</b>  | .187 x .032 [4.8 x .87] terminal tabs |
| <b>Operating Ambient Temperature Range (at rated current I<sub>r</sub>):</b>   | -10°C to +40°C                        |
| In an ambient temperature (T <sub>a</sub> ) higher than +40°C the maximum operating current (I <sub>o</sub> ) is calculated as follows: $I_o = I_r \sqrt{(85-T_a)/45}$ |                                       |

\*Holds one or two fuses. Conversion clip provided on fuseholder for single fuse models.

## Electrical Schematic



## Available Part Numbers

|           |           |
|-----------|-----------|
| PE000DD3D | PS000DD3D |
| PE000DD6D | PS000DD6D |
| PE000DDXD | PS000DDXD |
| PE000SD3D | PS000SD3D |
| PE000SD6D | PS000SD6D |
| PE000SDXD | PS000SDXD |

\*MOLEX is a trademark of MOLEX Incorporated

The CHAMELEON Adaptable Module for DC Applications *(continued)*

# P Series

## Case Styles

### PE



### PS



## Accessories



**GA210** - (shown above) Pre-assembled connector housing with two 36" long 18 gauge wires to mate with P Series DC filters

### MOLEX Part Numbers:

- 03-12-1026 DC Connector housing for P Series
- 18-12-1222 Female terminals (2 per connector)

## Case Dimensions

| Part No. | A                           | B                           | C                           | D                           | E                            | F                           |
|----------|-----------------------------|-----------------------------|-----------------------------|-----------------------------|------------------------------|-----------------------------|
|          | (max.)                      | (max.)                      | (max.)                      | *see note                   | *see note                    | (ref.)                      |
| PE       | <b>1.98</b><br><i>50.29</i> | <b>2.13</b><br><i>54.10</i> | <b>2.31</b><br><i>58.67</i> | <b>1.12</b><br><i>28.45</i> | <b>2.201</b><br><i>55.91</i> | <b>1.575</b><br><i>40.0</i> |
| PS       | <b>1.24</b><br><i>31.50</i> | <b>2.13</b><br><i>54.10</i> | <b>2.31</b><br><i>58.67</i> | <b>1.06</b><br><i>26.93</i> | <b>2.201</b><br><i>55.91</i> | -                           |

\*+.008 / -.000 [ +.20 / -.00 ]

## Recommended Panel Cutouts



Note: The external edges (installation side) on the "D" sides of the cutout should have a minimum .020" radius. For optimal retention against extraction, the corresponding inner edge should be sharp, without paint or coatings. Edge coatings, including anodization are also discouraged for good shield contact.

## Performance Data

### Minimum Insertion Loss

Measured in closed 50 Ohm system

Common Mode / Asymmetrical (Line to Ground)

| Current Rating | Frequency - MHz |    |     |    |    |    |    |    |    |
|----------------|-----------------|----|-----|----|----|----|----|----|----|
|                | .03             | .1 | .15 | .5 | 1  | 3  | 5  | 10 | 30 |
| 3A             | 7               | 17 | 21  | 27 | 33 | 40 | 44 | 50 | 32 |
| 6A             | -               | 8  | 12  | 17 | 23 | 32 | 36 | 44 | 30 |
| 15A            | -               | 3  | 5   | 10 | 13 | 23 | 27 | 35 | 27 |

Differential Mode / Symmetrical (Line to Line)

| Current Rating | Frequency - MHz |     |    |    |    |    |    |    |
|----------------|-----------------|-----|----|----|----|----|----|----|
|                | .1              | .15 | .5 | 1  | 3  | 5  | 10 | 30 |
| 3A             | 2               | 4   | 12 | 15 | 30 | 48 | 50 | 45 |
| 6A             | 2               | 4   | 12 | 15 | 22 | 42 | 55 | 45 |
| 15A            | 2               | 4   | 12 | 15 | 22 | 42 | 55 | 45 |

**5. Feedthrough Filters and Capacitors – Table of Contents**

**Feedthrough Application Selector Chart . . . . .225**  
**Introduction . . . . .226**  
 FFA Series . . . . .228  
 FFD Series . . . . .231  
 AFC Series . . . . .234  
 DFC Series . . . . .237

**Feedthrough Application Selector Chart**



---

## Introduction - Corcom Feedthrough Filters and Capacitors

---

### Installation, Background and Safety

Feedthrough capacitors and filters are designed for through-bulkhead mounting for offering high frequency filtering in line-to-ground applications. They should be mounted through a metal bulkhead or chassis. The bulkhead mounting surface should be clean and unpainted to offer a low impedance path from the capacitor or filter to the equipment chassis. Poor earth bonding will limit the available performance of the product and could compromise safety.

Conductive paint finishes should be avoided as they do not usually provide adequate conductivity. Two wrenches (or spanners) should be used when making electrical connections to the terminals and maximum tightening torque figures quoted should be observed.

Relevant safety standards have been adhered to in the design and manufacture of these products. However, all capacitors will store charge after power has been removed and must be treated with respect as this can be lethal when the voltage and charge are high enough. The filters and capacitors contained within this catalog do not contain internal discharge resistors. It is therefore recommended that they are fitted with external discharge resistors to discharge the capacitors after the power has been removed. Where necessary, terminals should be enclosed by the user to prevent any danger of electric shock or accidental shorting. In all cases, capacitors and filters should always be shorted to earth prior to touching to ensure they are fully discharged.

The user should ensure he/she is familiar with restrictions on capacitance value, earth leakage current, test voltage, and safety labeling requirements, which may be applicable to his/her particular installation. In particular, safety standards IEC950 and EN60950, which most electrical equipment needs to comply with, contain a number of specific requirements for capacitors, which may be applicable.

### Applications

Offers reliability and performance in high frequency applications such as:

- Servers
- Base stations
- Routers
- Main power supplies
- Telecom systems / racks
- MRI rooms
- High power microwave lines
- Military vehicles and equipment
- High current switch mode power supplies
- Power amplifier and generators
- Industrial controls
- Screened rooms
- High frequency welding equipment
- Secure communications
- Computer facilities

### Key Features

- Designed to meet EN133200 and EN132400 safety requirements
- Custom designs available where special packaging, mounting, terminations, or multiple lines are required.
- RoHS compliant

**Introduction - Corcom Feedthrough Filters and Capacitors**

**Feedthrough Capacitor Performance**

- Normal two-terminal capacitors resonate with their lead inductance in the region of 1 to 10MHz
- This limits their use as suppression components above a few MHz
- Feedthrough capacitors have no major resonance as they have no lead inductance
- Performance continues to increase with frequency
- Feedthrough capacitors are essential for good high frequency performance
- Feedthrough filters incorporate feedthrough capacitors for the same benefits
- As an example, the graph in Figure 1 compares the performance of a 1 $\mu$ F feedthrough capacitor with a 1 $\mu$ F two-terminal capacitor

**Figure 1: Feedthrough Filters Performance**



AC Feedthrough Filters - Class Y2

# FFA Series



Component Recognized by  
UL to US and Canadian Requirements



## FFA Series

- AC feedthrough filters
- Current Ratings from 10 to 300A
- Designed to meet the very stringent safety requirements of EN133200 class Y2 including the 5000V pulse test
- Custom versions available

## Ordering Information

10 FFA6 - BA



## Filter Options / Specifications

| Filter ID | Value (nF) | Inductance (nH) | Max. Leakage Current (mA)* | DC Resistance (mΩ) Max. |
|-----------|------------|-----------------|----------------------------|-------------------------|
| BA        | 2 x 4.7    | 70              | 0.9                        | 6                       |
| CA        | 2 x 10     | 70              | 1.9                        | 4                       |
| CE        | 2 x 10     | 140             | 1.9                        | 7                       |
| DG        | 2 x 22     | 170             | 4.2                        | 4                       |
| DH        | 2 x 22     | 180             | 4.2                        | 4                       |
| GB        | 2 x 47     | 80              | 8.9                        | 3                       |
| GJ        | 2 x 47     | 210             | 8.9                        | 9                       |
| HC        | 2 x 100    | 90              | 19                         | 2                       |
| HD        | 2 x 100    | 120             | 19                         | 1                       |
| HF        | 2 x 100    | 160             | 19                         | < 1                     |
| HN        | 2 x 100    | 250             | 19                         | 6                       |
| JK        | 2 x 150    | 240             | 29                         | 3                       |
| NP        | 2 x 470    | 330**           | 89                         | < 2                     |
| PP        | 2 x 1000   | 330             | 188                        | < 2                     |

\*@ 250 VAC 60 Hz  
\*\*240 for 100A Version

## Specifications

- Rated Voltage (max):** 250 VAC
- Operating Frequency:** 50/60 Hz
- Rated Current:** 10 to 300A
- Test Voltage (two seconds):** 5000 VDC
- Capacitor Class (EN133200):** Designed to meet Y2
- Pulse Test (EN133200):** 5000V Peak
- Insulation Resistance (within 1 minute):**  
For C < 0.33μF, R > 15000MΩ  
For C > 0.33μF, RC(MΩ\*μF) > 5000s
- Operating Ambient Temperature Range (at rated current I<sub>r</sub>):**  
10 to 100A: -40°C to +60°C  
200A: -40°C to +50°C  
250 & 300A: -40°C to +40°C
- Category Temperature Range:** -40°C to +85°C
- Current Derating Above Ambient:**  
10-100A: For temperature, θ I<sub>θ</sub> = IR √(85-θ)/25  
200A: For temperature, θ I<sub>θ</sub> = IR √(85-θ)/35  
250 & 300A: For temp., θ I<sub>θ</sub> = IR √(85-θ)/45
- Climatic Category:** 40/85/21
- MTBF:** > 5 million hours typical
- Insulating Materials Flammability Rating:** UL94V-0
- Case & Terminal Material:** Nickel Plated Brass

## Electrical Schematic

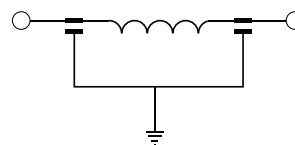

**AC Feedthrough Filters - Class Y2** *(continued)*

# FFA Series

## Case Style



### T1 - Terminal Thread

| Part No.         | Thread | Torque max. in.lb. |
|------------------|--------|--------------------|
| 10FFA6-BA/CE/CJ  | M3     | 4                  |
| 16FFA6-CA/DG/HN  | M4     | 11                 |
| 32FFA6-CA/DH/HN  | M4     | 11                 |
| 63FFA6-GB/JK/NP  | M6     | 22                 |
| 100FFA6-HC/NP/PP | M8     | 44                 |
| 200FFA6-HD/NP/PP | M10    | 70                 |
| 250FFA6-HF/NP/PP | M12    | 97                 |
| 300FFA6-HF/NP/PP | M16    | 177                |

### T2 - Mounting Thread

| Part No.         | Thread    | Torque max. in.lb. |
|------------------|-----------|--------------------|
| 10FFA6-BA/CE/CJ  |           |                    |
| 16FFA6-CA        | M12 x 1   | 35                 |
| 32FFA6-CA        |           |                    |
| 16FFA6-DG/HN     |           |                    |
| 32FFA6-DH/HN     | M16 x 1   | 62                 |
| 63FFA6-GB        |           |                    |
| 63FFA6-JK        | M20 x 1   | 89                 |
| 100FFA6-HC       |           |                    |
| 100FFA6-NP       | M24 x 1   | 124                |
| 200FFA6-HD       |           |                    |
| 63FFA6-NP        |           |                    |
| 100FFA6-PP       | M27 x 1.5 | 142                |
| 200FFA6-NP/PP    |           |                    |
| 250FFA6-HF/NP/PP | M32 x 1.5 | 212                |
| 300FFA6-HF/NP/PP |           |                    |

## Case Dimensions

| Part No.   | A                   | B                     | C                   | D                   | E                   | F                 |
|------------|---------------------|-----------------------|---------------------|---------------------|---------------------|-------------------|
|            | $\frac{\pm .04}{1}$ | $\frac{\pm .02}{0.5}$ | $\frac{\pm .08}{2}$ | $\frac{\pm .04}{1}$ | $\frac{\pm .08}{2}$ | (max)             |
| 10FFA6-BA  | <b>3.86</b><br>98   | <b>0.79</b><br>20     | <b>2.24</b><br>57   | <b>0.47</b><br>12   | <b>0.63</b><br>16   | <b>0.67</b><br>17 |
| 16FFA6-CA  | <b>4.17</b>         | <b>0.79</b>           | <b>2.40</b>         | <b>0.47</b>         | <b>0.71</b>         | <b>0.67</b>       |
| 32FFA6-CA  | 106                 | 20                    | 61                  | 12                  | 18                  | 17                |
| 63FFA6-GB  | <b>6.30</b><br>160  | <b>0.98</b><br>25     | <b>3.70</b><br>94   | <b>0.55</b><br>14   | <b>1.02</b><br>26   | <b>0.87</b><br>22 |
| 100FFA6-HC | <b>7.24</b><br>184  | <b>1.26</b><br>32     | <b>4.09</b><br>104  | <b>0.63</b><br>16   | <b>1.26</b><br>32   | <b>1.06</b><br>27 |
| 200FFA6-HD | <b>8.23</b><br>209  | <b>1.50</b><br>38     | <b>4.41</b><br>112  | <b>0.75</b><br>19   | <b>1.57</b><br>40   | <b>1.06</b><br>27 |
| 300FFA6-HF | <b>7.87</b><br>200  | <b>2.13</b><br>54     | <b>3.66</b><br>93   | <b>0.75</b><br>19   | <b>1.81</b><br>46   | <b>1.57</b><br>40 |
| 10FFA6-CE  | <b>4.21</b><br>107  | <b>0.79</b><br>20     | <b>2.60</b><br>66   | <b>0.47</b><br>12   | <b>0.63</b><br>16   | <b>0.67</b><br>17 |
| 16FFA6-DG  | <b>4.57</b>         | <b>0.98</b>           | <b>2.72</b>         | <b>0.55</b>         | <b>0.71</b>         | <b>0.87</b>       |
| 32FFA6-DH  | 116                 | 25                    | 69                  | 14                  | 18                  | 22                |
| 63FFA6-JK  | <b>6.81</b><br>173  | <b>1.26</b><br>32     | <b>4.13</b><br>105  | <b>0.63</b><br>16   | <b>1.02</b><br>26   | <b>1.06</b><br>27 |
| 100FFA6-NP | <b>8.98</b><br>228  | <b>1.50</b><br>38     | <b>5.71</b><br>145  | <b>0.75</b><br>19   | <b>1.26</b><br>32   | <b>1.06</b><br>27 |
| 200FFA6-NP | <b>9.57</b><br>243  | <b>2.13</b><br>54     | <b>5.75</b><br>146  | <b>0.75</b><br>19   | <b>1.57</b><br>40   | <b>1.57</b><br>40 |
| 250FFA6-NP | <b>10.51</b>        | <b>2.13</b>           | <b>6.30</b>         | <b>0.75</b>         | <b>1.81</b>         | <b>1.57</b>       |
| 300FFA6-HN | 267                 | 54                    | 160                 | 19                  | 46                  | 40                |
| 10FFA6-GJ  | <b>5.51</b><br>140  | <b>0.79</b><br>20     | <b>3.90</b><br>99   | <b>0.47</b><br>12   | <b>0.63</b><br>16   | <b>0.67</b><br>17 |
| 16FFA6-HN  | <b>5.83</b>         | <b>0.98</b>           | <b>3.98</b>         | <b>0.55</b>         | <b>0.71</b>         | <b>0.87</b>       |
| 32FFA6-HN  | 148                 | 25                    | 101                 | 14                  | 18                  | 22                |
| 63FFA6-NP  | <b>7.44</b><br>189  | <b>2.13</b><br>54     | <b>4.65</b><br>118  | <b>0.75</b><br>19   | <b>1.02</b><br>26   | <b>1.57</b><br>40 |
| 100FFA6-PP | <b>8.94</b><br>227  | <b>2.13</b><br>54     | <b>5.67</b><br>144  | <b>0.75</b><br>19   | <b>1.26</b><br>32   | <b>1.57</b><br>40 |
| 200FFA6-PP | <b>9.57</b><br>243  | <b>2.13</b><br>54     | <b>5.75</b><br>146  | <b>0.75</b><br>19   | <b>1.57</b><br>40   | <b>1.57</b><br>40 |
| 250FFA6-PP | <b>10.51</b>        | <b>2.13</b>           | <b>6.3</b>          | <b>0.75</b>         | <b>1.81</b>         | <b>1.57</b>       |
| 300FFA6-PP | 267                 | 54                    | 160                 | 19                  | 46                  | 40                |

Dimensions are in inches and millimeters unless otherwise specified. Values in italics are metric equivalents. Dimensions are shown for reference purposes only. Specifications subject to change.

For email, phone or live chat, please go to [te.com/help](http://te.com/help) or [corcom.com](http://corcom.com)

**AC Feedthrough Filters - Class Y2** *(continued)*

# FFA Series

## Available Part Numbers

| Standard Performance | High Performance | Extended Performance |
|----------------------|------------------|----------------------|
| 10FFA6-BA            | 10FFA6-CE        | 10FFA6-GJ            |
| 16FFA6-CA            | 16FFA6-DG        | 16FFA6-HN            |
| 32FFA6-CA            | 32FFA6-DH        | 32FFA6-HN            |
| 63FFA6-GB            | 63FFA6-JK        | 63FFA6-NP            |
| 100FFA6-HC           | 100FFA6-NP       | 100FFA6-PP           |
| 200FFA6-HD           | 200FFA6-NP       | 200FFA6-PP           |
| 250FFA6-HF           | 250FFA6-NP       | 250FFA6-PP           |
| 300FFA6-HF           | 300FFA6-NP       | 300FFA6-PP           |

## Performance Data

### Typical Insertion Loss – Line to Ground in 50 Ohm circuit

| Filter ID | Frequency – MHz |      |     |     |    |    |     |      |  |
|-----------|-----------------|------|-----|-----|----|----|-----|------|--|
|           | 0.01            | 0.03 | 0.1 | 0.3 | 1  | 10 | 100 | 1000 |  |
| BA        | -               | -    | -   | -   | 4  | 18 | 80  | 100  |  |
| CA        | -               | -    | 2   | 4   | 10 | 22 | 65  | 100  |  |
| CE        | -               | -    | 2   | 3   | 10 | 28 | 65  | 100  |  |
| DG        | -               | -    | 3   | 7   | 15 | 40 | 72  | 100  |  |
| DH        | -               | -    | 3   | 7   | 15 | 40 | 72  | 100  |  |
| GB        | -               | -    | 6   | 11  | 21 | 50 | 85  | 100  |  |
| GJ        | -               | -    | 5   | 12  | 21 | 60 | 90  | 100  |  |
| HC        | -               | 2    | 10  | 18  | 27 | 60 | 100 | 100  |  |
| HD        | -               | 2    | 10  | 18  | 27 | 60 | 100 | 100  |  |
| HF        | -               | 2    | 10  | 18  | 27 | 60 | 100 | 100  |  |
| HN        | 2               | 4    | 10  | 17  | 24 | 75 | 90  | 100  |  |
| JK        | 3               | 8    | 15  | 21  | 28 | 72 | 100 | 100  |  |
| NP        | 7               | 15   | 24  | 31  | 44 | 80 | 100 | 100  |  |
| PP        | 12              | 20   | 29  | 33  | 56 | 80 | 100 | 100  |  |



DC Feedthrough Filters - Class Y4

# FFD Series



Component Recognized by  
UL to US and Canadian Requirements



## FFD Series

- DC feedthrough filters
- Current ratings from 10 to 200A
- Designed to meet the very stringent safety requirements of EN133200 class Y4 including the 2500V pulse test
- Custom versions available

## Ordering Information

10 FFD6 - CA

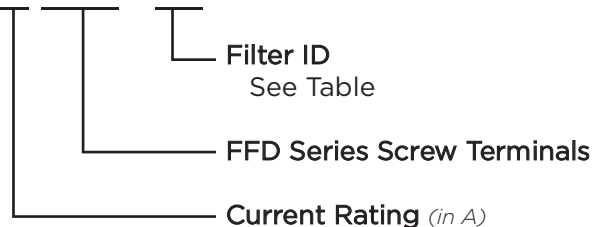

## Filter Options / Specifications

| Filter ID | Value (nF) | Inductance (nH) | DC Resistance (mΩ) Max. |
|-----------|------------|-----------------|-------------------------|
| CA        | 2 x 10     | 70              | 6                       |
| HB        | 2 x 100    | 80              | 3                       |
| HE        | 2 x 100    | 140             | 8                       |
| NC        | 2 x 470    | 90              | 2                       |
| ND        | 2 x 470    | 120             | 1                       |
| NH        | 2 x 470    | 180             | 3                       |
| PK        | 2 x 1000   | 240             | 2                       |
| RP        | 2 x 4700   | 330             | 2                       |

## Specifications

- Rated Voltage (max):** 130 VDC
- Rated Current:** 10 to 200A
- Test Voltage (two seconds):** 2500 VDC
- Capacitor Class (EN133200):** Designed to meet Y4
- Pulse Test (EN133200):** 2500V Peak
- Insulation Resistance (within 1 minute):**  
For C < 0.33μF, R > 15000MΩ  
For C > 0.33μF, RC(MΩ\*μF) > 5000s
- Operating Ambient Temperature Range (at rated current I<sub>r</sub>):**  
10 to 100A: -40°C to +60°C  
200A: -40°C to +50°C
- Category Temperature Range:** -40°C to +85°C
- Current Derating Above Ambient:**  
10-100A: For temperature, θ I<sub>θ</sub> = IR √(85-θ)/25  
200A: For temperature, θ I<sub>θ</sub> = IR √(85-θ)/35
- Climatic Category:** 40/85/21
- MTBF:** > 5 million hours typical
- Insulating Materials Flammability Rating:** UL94V-0
- Case & Terminal Material:** Nickel Plated Brass

## Electrical Schematic

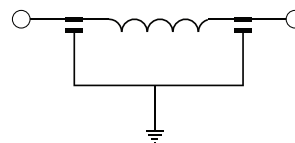

DC Feedthrough Filters - Class Y4 (continued)

# FFD Series

## Case Style



### T1 - Terminal Thread

| Part No.      | Thread | Torque max. in.lb. |
|---------------|--------|--------------------|
| 10FFD6-CA/HE  | M3     | 4                  |
| 16FFD6-CA/HE  | M4     | 11                 |
| 32FFD6-CA/HE  | M6     | 22                 |
| 63FFD6-HB/NH  | M6     | 22                 |
| 100FFD6-NC/PK | M8     | 44                 |
| 200FFD6-ND/RP | M10    | 70                 |

### T2 - Mounting Thread

| Part No.      | Thread    | Torque max. in.lb. |
|---------------|-----------|--------------------|
| 10FFD6-CA/HE  | M12 x 1   | 35                 |
| 16FFD6-CA/HE  |           |                    |
| 32FFD6-CA/HE  |           |                    |
| 63FFD6-HB/NH  | M20 x 1   | 89                 |
| 100FFD6-NC/PK | M24 x 1   | 124                |
| 200FFD6-ND/RP | M27 x 1.5 | 142                |

## Case Dimensions

| Part No.   | A                          | B                          | C                       | D                       | E                       | F                 |
|------------|----------------------------|----------------------------|-------------------------|-------------------------|-------------------------|-------------------|
|            | $\pm_{-0.04}^{+0.04}$<br>1 | $\pm_{-0.5}^{+0.2}$<br>0.5 | $\pm_{-2}^{+0.08}$<br>2 | $\pm_{-1}^{+0.04}$<br>1 | $\pm_{-2}^{+0.08}$<br>2 | (max)             |
| 10FFD6-CA  | <b>3.54</b><br>90          | <b>0.79</b><br>20          | <b>1.93</b><br>49       | <b>0.47</b><br>12       | <b>0.63</b><br>16       | <b>0.67</b><br>17 |
| 16FFD6-CA  | <b>3.86</b>                | <b>0.79</b>                | <b>2.09</b>             | <b>0.47</b>             | <b>0.71</b>             | <b>0.67</b>       |
| 32FFD6-CA  | 98                         | 20                         | 53                      | 12                      | 18                      | 17                |
| 63FFD6-HB  | <b>6.30</b><br>160         | <b>0.98</b><br>25          | <b>3.70</b><br>94       | <b>0.55</b><br>14       | <b>1.02</b><br>26       | <b>0.87</b><br>22 |
| 100FFD6-NC | <b>7.24</b><br>184         | <b>1.26</b><br>32          | <b>4.09</b><br>104      | <b>0.63</b><br>16       | <b>1.26</b><br>32       | <b>1.06</b><br>27 |
| 200FFD6-ND | <b>8.23</b><br>209         | <b>1.50</b><br>38          | <b>4.41</b><br>112      | <b>0.75</b><br>19       | <b>1.57</b><br>40       | <b>1.06</b><br>27 |
| 10FFD6-HE  | <b>5.12</b><br>130         | <b>0.79</b><br>20          | <b>3.50</b><br>89       | <b>0.47</b><br>12       | <b>0.63</b><br>16       | <b>0.67</b><br>17 |
| 16FFD6-HE  | <b>5.47</b>                | <b>0.79</b>                | <b>3.70</b>             | <b>0.47</b>             | <b>0.71</b>             | <b>0.67</b>       |
| 32FFD6-HE  | 139                        | 20                         | 94                      | 12                      | 18                      | 17                |
| 63FFD6-NH  | <b>6.81</b><br>173         | <b>1.26</b><br>32          | <b>4.13</b><br>105      | <b>0.63</b><br>16       | <b>1.02</b><br>26       | <b>1.06</b><br>27 |
| 100FFD6-PK | <b>8.98</b><br>173         | <b>1.50</b><br>32          | <b>5.71</b><br>105      | <b>0.75</b><br>16       | <b>1.26</b><br>26       | <b>1.06</b><br>27 |
| 200FFD6-RP | <b>10.98</b><br>279        | <b>2.13</b><br>54          | <b>7.17</b><br>182      | <b>0.75</b><br>19       | <b>1.57</b><br>40       | <b>1.57</b><br>40 |

**DC Feedthrough Filters - Class Y4** *(continued)*

# FFD Series

## Available Part Numbers

| Standard Performance | High Performance |
|----------------------|------------------|
| 10FFD6-CA            | 10FFD6-HE        |
| 16FFD6-CA            | 16FFD6-HE        |
| 32FFD6-CA            | 32FFD6-HE        |
| 63FFD6-HB            | 63FFD6-NH        |
| 100FFD6-NC           | 100FFD6-PK       |
| 200FFD6-ND           | 200FFD6-RP       |

## Performance Data

Typical Insertion Loss – Line to Ground in 50 Ohm circuit

| Filter ID | Frequency – MHz |      |     |     |    |     |     |      |
|-----------|-----------------|------|-----|-----|----|-----|-----|------|
|           | 0.01            | 0.03 | 0.1 | 0.3 | 1  | 10  | 100 | 1000 |
| CA        | -               | -    | 2   | 4   | 10 | 23  | 65  | 100  |
| HB        | 2               | 4    | 10  | 18  | 27 | 62  | 95  | 100  |
| HE        | 2               | 4    | 10  | 18  | 27 | 67  | 95  | 100  |
| NC        | 7               | 14   | 23  | 30  | 32 | 70  | 100 | 100  |
| ND        | 7               | 14   | 23  | 30  | 32 | 70  | 100 | 100  |
| NH        | 7               | 14   | 23  | 31  | 35 | 75  | 100 | 100  |
| PK        | 14              | 21   | 30  | 34  | 53 | 75  | 100 | 100  |
| RP        | 20              | 32   | 40  | 52  | 85 | 100 | 100 | 100  |

AC Feedthrough Capacitors - Class Y2

# AFC Series



Component Recognized by  
UL to US and Canadian Requirements



## AFC Series

- AC feedthrough capacitors
- Current ratings from 10 to 300A
- Designed to meet the very stringent safety requirements of EN132400 class Y2 including the 5000V pulse test
- Custom versions available

## Ordering Information



## Filter Options / Specifications

| Filter ID | Value (nF) | Max. Leakage Current (mA)* |
|-----------|------------|----------------------------|
| A         | 2.2        | 0.21                       |
| B         | 4.7        | 0.44                       |
| C         | 10         | 0.94                       |
| F         | 33         | 3.1                        |
| G         | 47         | 4.4                        |
| H         | 100        | 9.4                        |
| K         | 220        | 21                         |
| N         | 470        | 44                         |
| P         | 1000       | 94                         |

\*@250VAC 60 Hz

## Specifications

|   |  |
|---|--|
| Rated Voltage (max):  | 250 VAC  |
| Operating Frequency:  | 50/60 Hz   |
| Rated Current:  | 10 to 300A   |
| Test Voltage (two seconds):   | 5000 VDC   |
| Capacitor Class (EN132400):   | Designed to meet Y2  |
| Pulse Test (EN132400):  | 5000V Peak   |
| Insulation Resistance (within 1 minute):                                |  |
|   | For C < 0.33µF, R > 15000MΩ  |
|   | For C > 0.33µF, RC(MΩ*µF) > 5000s  |
| Operating Ambient Temperature Range (at rated current I <sub>r</sub> ): |  |
|   | 10 to 200A: -40°C to +60°C   |
|   | 250 & 300A: -40°C to +40°C   |
| Category Temperature Range:   | -40°C to +85°C   |
| Current Derating Above Ambient:   |  |
|   | 10-200A: For temperature, $\theta$ $I_{\theta} = IR \sqrt{(85-\theta)/25}$ |
|   | 250 & 300A: For temp., $\theta$ $I_{\theta} = IR \sqrt{(85-\theta)/45}$    |
| Climatic Category:  | 40/85/21   |
| MTBF:   | > 10 million hours typical   |
| Insulating Materials Flammability Rating:                               | UL94V-0  |
| Case & Terminal Material:   | Nickel Plated Brass  |

**AC Feedthrough Capacitors - Class Y2** *(continued)*

# AFC Series

## Case Style

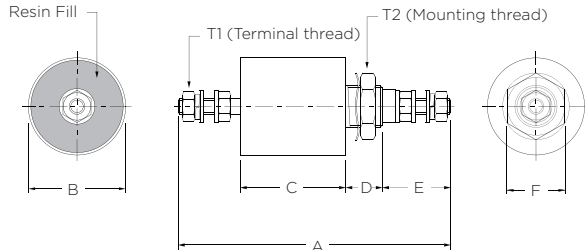

### T1 - Terminal Thread

| Part No.         | Thread | Torque max. in.lb. |
|------------------|--------|--------------------|
| 10AFC6-A/B       | M3     | 4                  |
| 16AFC6-B/C/G/H   | M4     | 11                 |
| 20AFC6-B         |        |                    |
| 32AFC6-B/C/F/G/H |        |                    |
| 63AFC6-C/G/H     | M6     | 22                 |
| 100AFC6-G/H/K/N  | M8     | 44                 |
| 200AFC6-H/K/N/P  | M10    | 71                 |
| 250AFC6-H/K/N/P  | M12    | 97                 |
| 300AFC6-H/K/N/P  | M16    | 177                |

### T2 - Mounting Thread

| Part No.       | Thread    | Torque max. in.lb. |
|----------------|-----------|--------------------|
| 10AFC6-A/B     | M10 x 1   | 27                 |
| 16AFC6-B/C/G   | M12 x 1   | 35                 |
| 20AFC6-B       |           |                    |
| 32AFC6-B/C/G/F |           |                    |
| 16AFC6-H       | M16 x 1   | 62                 |
| 32AFC6-H       |           |                    |
| 63AFC6-C/G/H   |           |                    |
| 100AFC6-G/H    | M20 x 1   | 89                 |
| 100AFC6-K/N    | M24 x 1   | 124                |
| 200AFC6-H/K    |           |                    |
| 200AFC6-N/P    | M27 x 1.5 | 142                |

## Case Dimensions

| Part No.  | A                     | B                    | C                  | D                  | E                  | F     |
|-----------|-----------------------|----------------------|--------------------|--------------------|--------------------|-------|
|           | $\pm_{-0.04}^{+0.04}$ | $\pm_{-0.5}^{+0.02}$ | $\pm_{-2}^{+0.08}$ | $\pm_{-1}^{+0.04}$ | $\pm_{-2}^{+0.08}$ | (max) |
| 10AFC6-A  | 2.24                  | 0.59                 | 0.71               | 0.39               | 0.63               | 0.51  |
| 10AFC6-B  | 57                    | 15                   | 18                 | 10                 | 16                 | 13    |
| 16AFC6-B  | 2.48                  | 0.79                 | 0.71               | 0.47               | 0.71               | 0.67  |
| 16AFC6-C  | 63                    | 20                   | 18                 | 12                 | 18                 | 17    |
| 16AFC6-G  | 2.95                  | 0.79                 | 1.18               | 0.47               | 0.71               | 0.67  |
|           | 75                    | 20                   | 30                 | 12                 | 18                 | 17    |
| 16AFC6-H  | 3.03                  | 0.98                 | 1.18               | 0.55               | 0.71               | 0.87  |
|           | 77                    | 25                   | 30                 | 14                 | 18                 | 22    |
| 20AFC6-B  | 2.48                  | 0.79                 | 0.71               | 0.47               | 0.71               | 0.67  |
|           | 63                    | 20                   | 18                 | 12                 | 18                 | 17    |
| 32AFC6-B  | 2.48                  | 0.79                 | 0.71               | 0.47               | 0.71               | 0.67  |
| 32AFC6-C  | 63                    | 20                   | 18                 | 12                 | 18                 | 17    |
| 32AFC6-F  | 2.95                  | 0.79                 | 1.18               | 0.47               | 0.71               | 0.67  |
| 32AFC6-G  | 75                    | 20                   | 30                 | 12                 | 18                 | 17    |
| 32AFC6-H  | 3.03                  | 0.98                 | 1.18               | 0.55               | 0.71               | 0.87  |
|           | 77                    | 25                   | 30                 | 14                 | 18                 | 22    |
| 63AFC6-C  | 3.78                  | 0.98                 | 1.18               | 0.55               | 1.02               | 0.87  |
| 63AFC6-G  | 96                    | 25                   | 30                 | 14                 | 26                 | 22    |
| 63AFC6-H  | 3.78                  | 0.98                 | 1.18               | 0.55               | 1.02               | 0.87  |
|           | 96                    | 25                   | 30                 | 14                 | 26                 | 22    |
| 100AFC6-G | 4.45                  | 1.26                 | 1.30               | 0.63               | 1.26               | 1.06  |
| 100AFC6-H | 113                   | 32                   | 33                 | 16                 | 32                 | 27    |
| 100AFC6-K | 4.57                  | 1.50                 | 1.30               | 0.75               | 1.26               | 1.06  |
|           | 116                   | 38                   | 33                 | 19                 | 32                 | 27    |
| 200AFC6-H | 5.24                  | 1.50                 | 1.97               | 0.75               | 1.26               | 1.06  |
| 200AFC6-K | 133                   | 38                   | 50                 | 19                 | 32                 | 27    |
| 200AFC6-N | 5.12                  | 1.50                 | 1.30               | 0.75               | 1.57               | 1.06  |
| 200AFC6-P | 130                   | 38                   | 33                 | 19                 | 40                 | 27    |
| 250AFC6-H | 5.79                  | 2.13                 | 1.97               | 0.75               | 1.57               | 1.57  |
| 250AFC6-K | 147                   | 54                   | 50                 | 19                 | 40                 | 40    |
| 250AFC6-N | 5.83                  | 2.13                 | 1.65               | 0.75               | 1.81               | 1.57  |
| 250AFC6-P | 148                   | 54                   | 42                 | 19                 | 46                 | 40    |
| 300AFC6-H | 6.30                  | 2.13                 | 2.13               | 0.75               | 1.81               | 1.57  |
| 300AFC6-K | 160                   | 54                   | 54                 | 19                 | 46                 | 40    |
| 300AFC6-N | 5.83                  | 2.13                 | 1.65               | 0.75               | 1.81               | 1.57  |
| 300AFC6-P | 148                   | 54                   | 42                 | 19                 | 46                 | 40    |

Dimensions are in inches and millimeters unless otherwise specified. Values in italics are metric equivalents. Dimensions are shown for reference purposes only. Specifications subject to change.

For email, phone or live chat, please go to [te.com/help](http://te.com/help) or [corcom.com](http://corcom.com)

**AC Feedthrough Capacitors - Class Y2** *(continued)*

# AFC Series

## Available Part Numbers

|          |           |           |
|----------|-----------|-----------|
| 10AFC6-A | 32AFC6-H  | 200AFC6-P |
| 10AFC6-B | 63AFC6-C  | 250AFC6-H |
| 16AFC6-B | 63AFC6-G  | 250AFC6-K |
| 16AFC6-C | 63AFC6-H  | 250AFC6-N |
| 16AFC6-G | 100AFC6-H | 250AFC6-P |
| 16AFC6-H | 100AFC6-H | 300AFC6-H |
| 20AFC6-B | 100AFC6-K | 300AFC6-K |
| 32AFC6-B | 100AFC6-N | 300AFC6-N |
| 32AFC6-C | 200AFC6-H | 300AFC6-P |
| 32AFC6-F | 200AFC6-K |           |
| 32AFC6-G | 200AFC6-N |           |

## Performance Data

### Typical Insertion Loss – Line to Ground in 50 Ohm circuit

| Filter ID | Frequency – MHz |      |     |     |    |    |     |      |
|-----------|-----------------|------|-----|-----|----|----|-----|------|
|           | 0.01            | 0.03 | 0.1 | 0.3 | 1  | 10 | 100 | 1000 |
| A         | -               | -    | -   | -   | -  | 8  | 38  | 45   |
| B         | -               | -    | -   | -   | -  | 14 | 43  | 60   |
| C         | -               | -    | -   | -   | 3  | 21 | 45  | 70   |
| F         | -               | -    | -   | 4   | 12 | 30 | 48  | 90   |
| G         | -               | -    | 2   | 6   | 15 | 34 | 50  | 90   |
| H         | -               | 2    | 5   | 11  | 20 | 40 | 65  | 90   |
| K         | -               | 4    | 11  | 18  | 27 | 45 | 85  | 90   |
| N         | 6               | 9    | 16  | 22  | 33 | 33 | 90  | 90   |
| P         | 10              | 15   | 22  | 30  | 40 | 42 | 90  | 90   |

DC Feedthrough Capacitors - Class Y4

# DFC Series



Component Recognized by  
UL to US and Canadian Requirements



## DFC Series

- DC feedthrough capacitors
- Current ratings from 10 to 300A
- Designed to meet the very stringent safety requirements of EN132400 class Y4 including the 2500V pulse test
- Custom versions available

## Ordering Information



## Filter Options / Specifications

| Filter ID | Value (nF) |
|-----------|------------|
| C         | 10         |
| G         | 47         |
| H         | 100        |
| N         | 470        |
| P         | 1000       |
| Q         | 3300       |
| R         | 4700       |
| T         | 8000       |

## Specifications

- Rated Voltage (max):** 130 VDC
- Rated Current:** 10 to 300A
- Test Voltage (two seconds):** 2500 VDC
- Capacitor Class (EN132400):** Designed to meet Y4
- Pulse Test (EN132400):** 2500V Peak
- Insulation Resistance (within 1 minute):**  
 For  $C < 0.33\mu\text{F}$ ,  $R > 15000\text{M}\Omega$   
 For  $C > 0.33\mu\text{F}$ ,  $RC(\text{M}\Omega \cdot \mu\text{F}) > 5000\text{s}$
- Operating Ambient Temperature Range (at rated current  $I_r$ ):**  
 10 to 200A:  $-40^\circ\text{C}$  to  $+60^\circ\text{C}$   
 250 & 300A:  $-40^\circ\text{C}$  to  $+40^\circ\text{C}$
- Category Temperature Range:**  $-40^\circ\text{C}$  to  $+85^\circ\text{C}$
- Current Derating Above Ambient:**  
 10-200A: For temperature,  $\theta$   $I_\theta = IR \sqrt{(85-\theta)/25}$   
 250 & 300A: For temp.,  $\theta$   $I_\theta = IR \sqrt{(85-\theta)/45}$
- Climatic Category:** 40/85/21
- MTBF:** > 10 million hours typical
- Insulating Materials Flammability Rating:** UL94V-0
- Case & Terminal Material:** Nickel Plated Brass

DC Feedthrough Capacitors - Class Y4 (continued)

# DFC Series

## Case Style



### T1 - Terminal Thread

| Part No.        | Thread | Torque max. in.lb. |
|-----------------|--------|--------------------|
| 10DFC6-C        | M3     | 4                  |
| 16DFC6-C/G/H/N  | M4     | 11                 |
| 32DFC6-C/G/H/N  | M4     | 11                 |
| 63DFC6-C/G/H/N  | M6     | 22                 |
| 100FDC6-G/H/N/P | M8     | 44                 |
| 200DFC6-H/N/P/R | M10    | 71                 |
| 250DFC6-P/Q/T   | M12    | 97                 |
| 300DFC6-P/Q/T   | M16    | 177                |

### T2 - Mounting Thread

| Part No.      | Thread    | Torque max. in.lb. |
|---------------|-----------|--------------------|
| 10DFC6-C      | M10 x 1   | 27                 |
| 16DFC6-C/G/H  | M12 x 1   | 35                 |
| 32DFC6-C/G/H  | M12 x 1   | 35                 |
| 63DFC6-C/G/H  | M16 x 1   | 62                 |
| 16DFC6-N      | M20 x 1   | 89                 |
| 32DFC6-N      | M20 x 1   | 89                 |
| 63DFC6-N      | M20 x 1   | 89                 |
| 100DFC6-G/H/N | M24 x 1   | 124                |
| 100DFC6-P     | M24 x 1   | 124                |
| 200DFC6-H/N/P | M24 x 1   | 124                |
| 200FFC6-R     | M27 x 1.5 | 142                |

## Case Dimensions

| Part No.  | A                  | B                    | C                  | D                  | E                  | F          |
|-----------|--------------------|----------------------|--------------------|--------------------|--------------------|------------|
|           | $\frac{\pm.04}{1}$ | $\frac{\pm.02}{0.5}$ | $\frac{\pm.08}{2}$ | $\frac{\pm.04}{1}$ | $\frac{\pm.08}{2}$ | (max)      |
| 10DFC6-C  | 2.24<br>57         | 0.59<br>15           | 0.71<br>18         | 0.39<br>10         | 0.63<br>16         | 0.51<br>13 |
| 16DFC6-C  | 2.48<br>63         | 0.79<br>20           | 0.71<br>18         | 0.47<br>12         | 0.71<br>18         | 0.67<br>17 |
| 16DFC6-G  | 2.95               | 0.79                 | 1.18               | 0.47               | 0.71               | 0.67       |
| 16DFC6-H  | 75                 | 20                   | 30                 | 12                 | 18                 | 17         |
| 16DFC6-N  | 3.23<br>82         | 1.26<br>32           | 1.30<br>33         | 0.63<br>16         | 0.71<br>18         | 1.06<br>27 |
| 32DFC6-C  | 2.48<br>63         | 0.79<br>20           | 0.71<br>18         | 0.47<br>12         | 0.71<br>18         | 0.67<br>17 |
| 32DFC6-G  | 2.95               | 0.79                 | 1.18               | 0.47               | 0.71               | 0.67       |
| 32DFC6-H  | 75                 | 20                   | 30                 | 12                 | 18                 | 17         |
| 32DFC6-N  | 3.23<br>82         | 1.26<br>32           | 1.30<br>33         | 0.63<br>16         | 0.71<br>18         | 1.06<br>27 |
| 63DFC6-C  | 3.78               | 0.98                 | 1.18               | 0.55               | 1.02               | 0.87       |
| 63DFC6-G  | 96                 | 25                   | 30                 | 14                 | 26                 | 22         |
| 63DFC6-H  | 3.98               | 1.26                 | 1.30               | 0.63               | 1.02               | 1.06       |
| 63DFC6-N  | 101                | 32                   | 33                 | 16                 | 26                 | 27         |
| 100DFC6-G | 4.45               | 1.26                 | 1.30               | 0.63               | 1.26               | 1.06       |
| 100DFC6-H | 113                | 32                   | 33                 | 16                 | 32                 | 27         |
| 100DFC6-N | 5.24<br>133        | 1.50<br>38           | 1.97<br>50         | 0.75<br>19         | 1.26<br>32         | 1.06<br>27 |
| 100DFC6-P | 5.24<br>133        | 1.50<br>38           | 1.97<br>50         | 0.75<br>19         | 1.26<br>32         | 1.06<br>27 |
| 200DFC6-H | 5.12               | 1.26                 | 1.30               | 0.75               | 1.57               | 1.06       |
| 200DFC6-N | 130                | 32                   | 33                 | 19                 | 40                 | 27         |
| 200DFC6-P | 5.79<br>147        | 1.50<br>38           | 1.97<br>50         | 0.75<br>19         | 1.57<br>40         | 1.06<br>27 |
| 200DFC6-R | 6.50<br>165        | 2.13<br>54           | 2.68<br>68         | 0.75<br>19         | 1.57<br>40         | 1.57<br>40 |
| 250DFC6-P | 5.83               | 2.13                 | 1.65               | 0.75               | 1.81               | 1.57       |
| 300DFC6-P | 148                | 54                   | 42                 | 19                 | 46                 | 40         |
| 250DFC6-Q | 6.30               | 2.13                 | 2.13               | 0.75               | 1.81               | 1.57       |
| 300DFC6-Q | 160                | 54                   | 54                 | 19                 | 46                 | 40         |
| 250DFC6-T | 7.01               | 2.13                 | 2.83               | 0.75               | 1.81               | 1.57       |
| 300DFC6-T | 178                | 54                   | 72                 | 19                 | 46                 | 40         |



**DC Feedthrough Capacitors - Class Y4** *(continued)*

# DFC Series

## Available Part Numbers

|          |           |           |           |
|----------|-----------|-----------|-----------|
| 10DFC6-C | 32DFC6-H  | 100DFC6-H | 250DFC6-P |
| 16DFC6-C | 32DFC6-N  | 100DFC6-N | 250DFC6-Q |
| 16DFC6-G | 63DFC6-C  | 100DFC6-P | 250DFC6-T |
| 16DFC6-H | 63DFC6-G  | 200DFC6-H | 300DFC6-P |
| 16DFC6-N | 63DFC6-H  | 200DFC6-N | 300DFC6-Q |
| 32DFC6-C | 63DFC6-N  | 200DFC6-P | 300DFC6-T |
| 32DFC6-G | 100DFC6-G | 200DFC6-R |           |

## Performance Data

**Typical Insertion Loss** – Line to Ground in 50 Ohm circuit

| Filter ID | Frequency – MHz |      |     |     |    |    |     |      |
|-----------|-----------------|------|-----|-----|----|----|-----|------|
|           | 0.01            | 0.03 | 0.1 | 0.3 | 1  | 10 | 100 | 1000 |
| C         | -               | -    | -   | -   | 3  | 21 | 45  | 70   |
| G         | -               | -    | 2   | 6   | 15 | 34 | 50  | 90   |
| H         | -               | 2    | 5   | 11  | 20 | 40 | 65  | 90   |
| N         | 6               | 9    | 15  | 22  | 33 | 33 | 90  | 90   |
| P         | 10              | 15   | 24  | 32  | 42 | 50 | 90  | 90   |
| Q         | 13              | 21   | 31  | 42  | 50 | 58 | 90  | 90   |
| R         | 18              | 26   | 36  | 45  | 42 | 70 | 90  | 90   |
| T         | 22              | 31   | 41  | 52  | 62 | 82 | 90  | 90   |

---

**Engineering Notes**

---



---

**6. Signal Line Products – Table of Contents**

---

|  |            |
|--|------------|
| Introduction .....   | 242        |
| SignalSentry Filtered Modular Jacks .....                          | 243        |
| SignalSentry Product Part Number Matrix / Ordering Information ... | 244        |
| SignalSentry Product Selector Chart .....                          | 245        |
| L Series .....   | 247        |
| L - Ganged Series .....  | 248        |
| LC Series .....  | 249        |
| LCT Series .....   | 250        |
| N Series .....   | 251        |
| X Series .....   | 252        |
| Z Series .....   | 253        |
| <b>Model Dimensions .....</b>                                      | <b>255</b> |
| L, LC, LCT and X Series RJ Jack Dimensions .....                   | 255        |
| N and Z Series RJ Jack Dimensions .....                            | 257        |

---

## Introduction

---

Corcom brand SignalSentry filtered modular jack series product combines different levels of filtering with RJ45 and RJ11 modular jacks to solve signal line noise problems and crosstalk.



Corcom brand SignalSentry filtered modular jack series product has expanded into 80 different products for filtering the signal line, including inductor and capacitor, shielded, ganged, low profile and surface mountable versions. Designs not only save valuable panel space, but also place the filtering elements where they can be most effective in eliminating RFI.

The L and N series RJ11 and RJ45 jacks offer filtering with inductance and optional shielding, while the LC and LCT series combine inductance with 82pF or 820pF capacitors. The X and Z series complete the offering with unfiltered versions of our standard profile and low profile jacks.

Use the selector chart to combine your filtering performance with the RJ11 or RJ45 jacks. Mechanical dimensions are listed following the series information.

For the latest information and additional technical articles, find Corcom products on the Internet at [www.corcom.com](http://www.corcom.com).

## SignalSentry Filtered Modular Jacks

Corcom brand SignalSentry filtered modular jacks are a space saving and cost-effective solution to RFI problems on signal lines. Its inductive and optional capacitive elements effectively strip common-mode noise from the incoming signal, and at the same time limit the signal line's ability to radiate emissions like an antenna.

The SignalSentry filtered modular jack series has expanded into 80 different products for filtering the signal line, including inductor and capacitor, shielded, ganged, low profile and surface mountable versions. Filtered RJ jacks provide interference suppression at the optimal location by integrating the filtering into the RJ jack itself. Our new ganged jacks are the only RJ11 filtered ganged jacks available in the market.

SignalSentry filtered modular jack products are useful for any electronic equipment that sends or receives data on unshielded twisted pair or other multi-conductor cabling systems. Modems, PBX's, LAN, ISDN, and local I/O interfaces that use RJ connectors are all candidates. Jack design and component selection compatible with equipment registered under FCC part 68.

 UL Recognized

 CSA Certified

### Applications

A fax/modem board was being certified for FCC Class B emissions at an independent test laboratory. The board caused every computer it was tested in to exceed the radiated limits above 30 MHz, at multiples of each microprocessor's clock frequency, on the telephone line.



The test lab replaced the modem's unfiltered RJ11 jack with a **Corcom RJ11-4L-B** filtered modular jack out of their sample kit, and the board/computer combinations passed with 4 dB margin worst case.



A RISC workstation designed to operate in a twisted-pair Local Area Network required two DIP package inductors and 12 chip capacitors to meet



FCC radiated emissions limits. All 14 discrete components were eliminated by replacing the two RJ45 connectors with two **Corcom RJ45-8LC1-B** shielded and filtered jacks, and the margin of compliance actually improved.



A secure telephone set failed hardened application testing at a government facility, due to intelligible emanations radiated from the coiled handset cord. The unit passed after the handset connector in the desk set was replaced by a **Corcom RJH-4L-B** filtered handset jack.



A medical manufacturer was designing a heart monitor which would transfer data over a signal line to the nurses' station so they could monitor patients. When the doctors used their modems, the data coming from the monitor became distorted.

This occurred due to the close proximity of the modem card and monitor communication card placed next to each other. A **Corcom low profile RJ45-8N3-B** modular jack was designed in to filter out the unwanted noise.

**SignalSentry Part Number Matrix / Ordering Information**

**WHAT TYPE OF CONNECTOR DO YOU NEED?**

Handset jack four pin connector  
RJ11 six pin connector  
RJ45 eight pin connector

RJH  
RJ11  
RJ45

**RJ11-4L1-B**

**HOW MANY TERMINALS WILL BE LOADED?** (See below)

4 on RJH  
2, 4 or 6 on RJ11  
6 or 8 on RJ45

**RJ11-4L1-B**

**WHAT LEVEL OF FILTERING PERFORMANCE DO YOU NEED?**

No filter, standard profile  
Inductor (block or sleeve), standard profile  
Inductor plus capacitors with shield  
Inductor, 82 pF cap. and shield  
Inductor (block or sleeve), low profile  
No filter, low profile

X models  
L models  
LC models  
LCT model  
N models  
Z models

**RJ11-4L1-B**

**DO YOU WANT A SHIELDED JACK?** (Optional on L, X, N, Z models, required on LC or LCT.)

**WHAT TYPE OF GROUND?**

<sup>1</sup>Panel and board ground (spring fingers on panel interface)  
<sup>1</sup>Board ground pins only  
<sup>2</sup>Panel, board and cable ground (low profile versions)  
<sup>2</sup>Board ground and cable ground (low profile versions)

1  
2  
3  
4

**RJ11-4L1-B**

<sup>1</sup>L, LC, LCT, X models  
<sup>2</sup>N, Z models

**WHAT TYPE OF INDUCTORS DO YOU NEED?**

Sleeve — Average performance  
Block — Higher performance

S  
B

**RJ11-4L1-B**

Sleeve inductance is recommended in cases where crosstalk may be a problem.

**RJ11 Model Contact Loading Program**



**RJ45 Model Contact Loading Program**



| Jack Designation | Lead Frame Position |   |   |   |   |   |
|------------------|---------------------|---|---|---|---|---|
|                  | 1                   | 2 | 3 | 4 | 5 | 6 |
| RJ11 - 2         |                     |   | X | X |   |   |
| RJ11 - 4         |                     | X | X | X | X |   |
| RJ11 - 6         | X                   | X | X | X | X | X |

| Jack Designation | Lead Frame Position |   |   |   |   |   |   |   |
|------------------|---------------------|---|---|---|---|---|---|---|
|                  | 1                   | 2 | 3 | 4 | 5 | 6 | 7 | 8 |
| RJ45 - 6         |                     | X | X | X | X | X | X |   |
| RJ45 - 8         | X                   | X | X | X | X | X | X | X |

**SignalSentry Selector Chart**



---

### Engineering Notes

---





**Inductive Filtering Modular RJ Jacks**

# L Series



UL Recognized  
CSA Certified



## L Series

- Inductive filtering in standard RJ11, RJ45, or handset jacks.
- Available with standard ferrite sleeve inductors or higher performance ferrite blocks
- Available unshielded or shielded with board grounded shield or spring fingered panel ground interface

### Available Part Numbers

| Inductor Filter |           |
|-----------------|-----------|
| RJH-4L-B        | RJ45-6L-S |
| RJ11-2L-S       | RJ45-6L-B |
| RJ11-2L-B       | RJ45-8L-S |
| RJ11-4L-S       | RJ45-8L-B |
| RJ11-4L-B       |           |
| RJ11-6L-S       |           |
| RJ11-6L-B       |           |

| Inductor Filter and Shield |            |
|----------------------------|------------|
| RJ11-2L2-B                 | RJ45-6L1-S |
| RJ11-4L1-S                 | RJ45-6L1-B |
| RJ11-4L1-B                 | RJ45-6L2-S |
| RJ11-4L2-S                 | RJ45-6L2-B |
| RJ11-4L2-B                 | RJ45-8L1-S |
| RJ11-6L1-S                 | RJ45-8L1-B |
| RJ11-6L1-B                 | RJ45-8L2-S |
| RJ11-6L2-S                 | RJ45-8L2-B |
| RJ11-6L2-B                 |            |



## Specifications

- Contacts:**  
 Material: Phosphor Bronze  
 Plating: 50 microinches gold  
 Barrier underplating: 100 microinches nickel  
 Resistance:  
     Initial: 20 mΩ max.  
     After 500 mating cycles: 30 mΩ max.
- Ferrites:**  
 Type: High resistivity, nickel zinc ceramic  
 Sleeves: Single-aperture cylinders  
 Block: Multi-aperture rectangular prism
- Shield Material:** Tin-plated copper alloy
- Housing Material:** Glass-filled polyester (UL94V-0)
- Dielectric Withstanding Voltage:**  
 Line to Line and Line to Ground: 1000 VAC for 60 seconds
- Printed Circuit Board Retention:**  
 Before soldering: 1 lb. minimum  
 After soldering: 20 lb. minimum

## Typical Impedance in Ohms



Model dimensions and PC board layout on pages 255-259

Inductive Filtering Ganged Modular RJ Jacks

# L - Ganged Series



UL Recognized  
CSA Certified



## L - Ganged Series

- Ganged version of our L Series filtered jacks
- Available in RJ11 models with block inductors
- Available in gangs of 2, 4 or 6
- Retrofits existing unfiltered ganged jack footprints

## Dimensions and PC Board Layout



| Ports | A           | B           | C            | D           |
|-------|-------------|-------------|--------------|-------------|
| 2     | <b>0.99</b> | <b>0.87</b> | <b>0.795</b> | <b>.87</b>  |
|       | 25.15       | 22.1        | 20.19        | 22.1        |
| 4     | <b>1.93</b> | <b>1.81</b> | <b>1.735</b> | <b>1.81</b> |
|       | 49.02       | 45.97       | 44.07        | 25.97       |
| 6     | <b>2.87</b> | <b>2.75</b> | <b>2.675</b> | <b>2.75</b> |
|       | 72.9        | 69.85       | 67.95        | 69.85       |

## Specifications

**Contacts:**  
 Material: Phosphor Bronze  
 Plating: 50 microinches gold  
 Barrier underplating: 100 microinches nickel  
 Resistance:  
     Initial: 20 mΩ max.  
     After 500 mating cycles: 30 mΩ max.

**Ferrites:**  
 Type: High resistivity, nickel zinc ceramic  
 Block: Multi-aperture rectangular prism

**Housing Material:** Glass-filled polyester (UL94V-0)

**Dielectric Withstanding Voltage:**  
 Line to Line and Line to Ground: 1000 VAC for 60 seconds

**Printed Circuit Board Retention:**  
 Before soldering: 1 lb. minimum  
 After soldering: 20 lb. minimum

## Available Part Numbers

|            |            |
|------------|------------|
| 2RJ11-6L-B | 4RJ11-6L-B |
| 6RJ11-6L-B |            |

## Typical Impedance in Ohms



**Filtered Modular Jacks with Enhanced Performance**

# LC Series



UL Recognized  
CSA Certified



## LC Series

- Chip capacitors provide enhanced filtering performance on each line
- Available with block or sleeve inductance
- Available with board grounded shield or spring fingered panel ground interface

## Performance Data

### Typical Insertion Loss

Line to ground (stop band) in 50 Ohm circuit

| Model               | Frequency – MHz |    |    |     |     |     |      |
|---------------------|-----------------|----|----|-----|-----|-----|------|
|                     | 30              | 60 | 80 | 100 | 200 | 500 | 1000 |
| S – Ferrite Sleeves | 28              | 40 | 51 | 40  | 27  | 24  | 22   |
| B – Ferrite Blocks  | 30              | 41 | 59 | 40  | 31  | 28  | 24   |

Line to line (pass band) in 50 Ohm circuit

| Model               | Frequency – MHz |   |    |    |    |    |     |
|---------------------|-----------------|---|----|----|----|----|-----|
|                     | 2               | 5 | 10 | 30 | 50 | 70 | 100 |
| S – Ferrite Sleeves | -               | 4 | 8  | 18 | 24 | 30 | 40  |
| B – Ferrite Blocks  | 1               | 8 | 11 | 21 | 28 | 33 | 37  |

Model dimensions and PC board layout on pages 255-259

## Specifications

**Contacts:**  
 Material: Phosphor Bronze  
 Plating: 50 microinches gold  
 Barrier underplating: 100 microinches nickel  
 Resistance:  
 Initial: 20 mΩ max.  
 After 500 mating cycles: 30 mΩ max.

**Capacitors:**  
 Type: Monolithic ceramic chip  
 Standard Value: 820 pF  
 Standard Tolerance: ± 20%

**Ferrites:**  
 Type: High resistivity, nickel zinc ceramic  
 Sleeves: Single-aperture cylinders  
 Block: Multi-aperture rectangular prism

**Shield Material:** Tin-plated copper alloy

**Housing Material:** Glass-filled polyester (UL94V-0)

**Dielectric Withstanding Voltage:**  
 Line to Line and Line to Ground: 1000 VAC for 60 seconds

**Printed Circuit Board Retention:**  
 Before soldering: 1 lb. minimum  
 After soldering: 20 lb. minimum

## Available Part Numbers

|             |             |
|-------------|-------------|
| RJ11-2LC1-S | RJ11-6LC2-S |
| RJ11-2LC1-B | RJ11-6LC2-B |
| RJ11-2LC2-S | RJ45-6LC1-S |
| RJ11-2LC2-B | RJ45-6LC1-B |
| RJ11-4LC1-S | RJ45-6LC2-S |
| RJ11-4LC1-B | RJ45-6LC2-B |
| RJ11-4LC2-S | RJ45-8LC1-S |
| RJ11-4LC2-B | RJ45-8LC1-B |
| RJ11-6LC1-S | RJ45-8LC2-S |
| RJ11-6LC1-B | RJ45-8LC2-B |

Low Capacitance Modular RJ Jacks

# LCT Series



UL Recognized  
CSA Certified

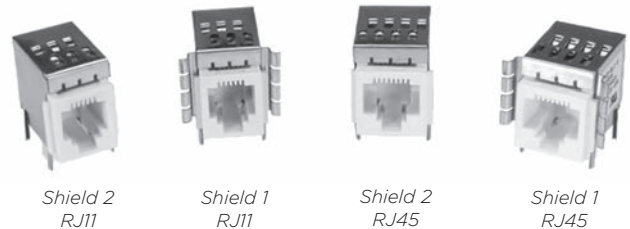

## LCT Series

- Low capacitance model for improved performance.
- Particularly suited for ethernet applications
- Available with block or sleeve inductance
- Available with board grounded shield or spring fingered panel ground interface

## Performance Data

### Typical Insertion Loss

Line to ground (stop band) in 50 Ohm circuit

| Model               | Frequency – MHz |     |     |     |     |     |      |
|---------------------|-----------------|-----|-----|-----|-----|-----|------|
|                     | 40              | 100 | 200 | 250 | 300 | 500 | 1000 |
| S – Ferrite Sleeves | 8               | 12  | 27  | 50  | 38  | 25  | 20   |
| B – Ferrite Blocks  | 10              | 18  | 22  | 55  | 40  | 28  | 24   |

Line to line (pass band) in 50 Ohm circuit

| Model               | Frequency – MHz |     |     |    |    |    |     |
|---------------------|-----------------|-----|-----|----|----|----|-----|
|                     | 2               | 5   | 10  | 30 | 50 | 70 | 100 |
| S – Ferrite Sleeves | -               | 1.2 | 1.9 | 4  | 5  | 7  | 10  |
| B – Ferrite Blocks  | 1               | 2   | 3   | 5  | 8  | 10 | 13  |

Model dimensions and PC board layout on pages 255-259

## Specifications

**Contacts:**  
 Material: Phosphor Bronze  
 Plating: 50 microinches gold  
 Barrier underplating: 100 microinches nickel  
 Resistance:  
     Initial: 20 mΩ max.  
     After 500 mating cycles: 30 mΩ max.

**Capacitors:**  
 Type: Monolithic ceramic chip  
 Standard Value: 82 pF  
 Standard Tolerance: ± 20%

**Ferrites:**  
 Type: High resistivity, nickel zinc ceramic  
 Sleeves: Single-aperture cylinders  
 Block: Multi-aperture rectangular prism

**Shield Material:** Tin-plated copper alloy

**Housing Material:** Glass-filled polyester (UL94V-0)

**Dielectric Withstanding Voltage:**  
 Line to Line and Line to Ground: 1000 VAC for 60 seconds

**Printed Circuit Board Retention:**  
 Before soldering: 1 lb. minimum  
 After soldering: 20 lb. minimum

## Available Part Numbers

|              |              |
|--------------|--------------|
| RJ11-6LCT1-S | RJ45-8LCT1-S |
| RJ11-6LCT1-B | RJ45-8LCT1-B |
| RJ11-6LCT2-S | RJ45-8LCT2-S |
| RJ11-6LCT2-B | RJ45-8LCT2-B |

Low Profile Filtered Modular Jacks

# N Series



UL Recognized  
CSA Certified



Shield 3  
RJ11



Shield 4  
RJ45

## N Series

- Low profile SignalSentry filtered jack
- Available with sleeve or block inductors
- Available unshielded or shielded with board grounded shield or spring fingered panel ground interface

### Typical Impedance in Ohms



Unshielded  
Ferrite Block

## Specifications

**Contacts:**  
 Material: Phosphor Bronze  
 Plating: 50 microinches gold  
 Barrier underplating: 100 microinches nickel  
 Resistance:  
     Initial: 20 mΩ max.  
     After 500 mating cycles: 30 mΩ max.

**Ferrites:**  
 Type: High resistivity, nickel zinc ceramic  
 Sleeves: Single-aperture cylinders  
 Block: Multi-aperture rectangular prism

**Shield Material:** Tin-plated copper alloy

**Housing Material:** Black glass-filled polyamide (STANYL TE250F3)

**Dielectric Withstanding Voltage:**  
 Line to Line and Line to Ground: 1000 VAC for 60 seconds

**Printed Circuit Board Retention:**  
 Before soldering: 1 lb. minimum  
 After soldering: 20 lb. minimum

## Available Part Numbers

|            |            |
|------------|------------|
| RJ11-6N-B  | RJ45-8N-B  |
|            | RJ45-8N-S  |
| RJ11-6N3-B | RJ45-8N3-B |
|            | RJ45-8N3-S |
| RJ11-6N4-B | RJ45-8N4-B |
|            | RJ45-8N4-S |

Model dimensions and PC board layout on pages 255-259

Unfiltered Modular Jacks

# X Series



UL Recognized  
CSA Certified



RJ45



RJ11

## X Series

- Unfiltered standard jack
- RJ11 or RJ45
- 2, 4, 6 or 8 loaded contacts
- Available unshielded or shielded with board grounded shield or spring fingered panel ground interface



Shield 1



Shield 2

## Specifications

|   |                                  |
|---|----------------------------------|
| <b>Contacts:</b>                        |                                  |
| Material:                               | Phosphor Bronze                  |
| Plating:                                | 50 microinches gold              |
| Barrier underplating:                   | 100 microinches nickel           |
| Resistance:                             |                                  |
| Initial:                                | 20 mΩ max.                       |
| After 500 mating cycles:                | 30 mΩ max.                       |
| <b>Shield Material:</b>                 | Tin-plated copper alloy          |
| <b>Housing Material:</b>                | Glass-filled polyester (UL94V-0) |
| <b>Dielectric Withstanding Voltage:</b> |                                  |
| Line to Line and Line to Ground:        | 1000 VAC for 60 seconds          |
| <b>Printed Circuit Board Retention:</b> |                                  |
| Before soldering:                       | 1 lb. minimum                    |
| After soldering:                        | 20 lb. minimum                   |

## Available Part Numbers

|         |          |
|---------|----------|
| RJ11-2X | RJ45-6X  |
| RJ11-4X | RJ45-8X  |
| RJ11-6X | RJ45-8X1 |
|         | RJ45-8X2 |

Model dimensions and PC board layout on pages 255-259

Low Profile Unfiltered Modular Jacks

# Z Series



UL Recognized  
CSA Certified

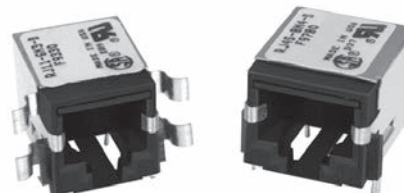

Shield 3  
RJ11

Shield 4  
RJ45

## Z Series

- Low profile
- Unfiltered
- Available unshielded or shielded with board grounded shield or spring fingered panel ground interface

## Available Part Numbers

|          |          |
|----------|----------|
| RJ11-6Z  | RJ45-8Z  |
| RJ11-6Z3 | RJ45-8Z3 |
| RJ11-6Z4 | RJ45-8Z4 |

## Specifications

|   |  |
|---|--|
| <b>Contacts:</b>                        |  |
| Material:                               | Phosphor Bronze                          |
| Plating:                                | 50 microinches gold                      |
| Barrier underplating:                   | 100 microinches nickel                   |
| Resistance:                             |  |
| Initial:                                | 20 mΩ max.                               |
| After 500 mating cycles:                | 30 mΩ max.                               |
| <b>Shield Material:</b>                 | Tin-plated copper alloy                  |
| <b>Housing Material:</b>                | Black glass-filled polyester (VALOX 457) |
| <b>Dielectric Withstanding Voltage:</b> |  |
| Line to Line and Line to Ground:        | 1000 VAC for 60 seconds                  |
| <b>Printed Circuit Board Retention:</b> |  |
| Before soldering:                       | 1 lb. minimum                            |
| After soldering:                        | 20 lb. minimum                           |

Model dimensions and PC board layout on pages 255-259

---

## Engineering Notes

---

A large, empty grid area for writing engineering notes, consisting of a uniform pattern of small squares.



Model Dimensions

L, LC, LCT and X Series RJ Jack Dimensions

RJ11 - No Shield



| Part No.  |           |         |
|-----------|-----------|---------|
| RJ11-2L-S | RJ11-2L-B | RJ11-2X |
| RJ11-4L-S | RJ11-4L-B | RJ11-4X |
| RJ11-6L-S | RJ11-6L-B | RJ11-6X |

RJ11 - Style 2 Shield



| Part No.    |             |            |              |
|-------------|-------------|------------|--------------|
| RJ11-2LC2-S | RJ11-2LC2-B | RJ11-4L2-S | RJ11-6L2-B   |
| RJ11-4LC2-S | RJ11-4LC2-B | RJ11-6L2-S | RJ11-6LCT2-S |
| RJ11-6LC2-S | RJ11-6LC2-B | RJ11-4L2-B | RJ11-6LCT2-B |

RJ11 - Style 1 Shield



| Part No.    |             |            |              |
|-------------|-------------|------------|--------------|
| RJ11-2LC1-S | RJ11-2LC1-B | RJ11-4L1-S | RJ11-6L1-B   |
| RJ11-4LC1-S | RJ11-4LC1-B | RJ11-6L1-S | RJ11-6LCT1-S |
| RJ11-6LC1-S | RJ11-6LC1-B | RJ11-4L1-B | RJ11-6LCT1-B |

RJ11 - PC Board Layout



For all RJ11 L, LC, LCT and X Series Models  
Shown from Component Side

All tolerances  $\pm 0.010$  [0.25] unless otherwise noted

Model Dimensions (continued)

L, LC, LCT and X Series RJ Jack Dimensions (continued)

RJ45 - No Shield



Part No.

|           |           |
|-----------|-----------|
| RJ45-6L-S | RJ45-8L-B |
| RJ45-8L-S | RJ45-6X   |
| RJ45-6L-B | RJ45-8X   |

RJ45 - Style 2 Shield



Part No.

|              |              |             |             |
|--------------|--------------|-------------|-------------|
| RJ45-6LC2-S  | RJ45-8LC2-S  | RJ45-6LC2-B | RJ45-8LC2-B |
| RJ45-6L2-S   | RJ45-8L2-S   | RJ45-6L2-B  | RJ45-8L2-B  |
| RJ45-8LCT2-S | RJ45-8LCT2-B |             |             |

RJ45 - Style 1 Shield



Part No.

|              |              |             |
|--------------|--------------|-------------|
| RJ45-6LC1-S  | RJ45-8LC1-S  | RJ45-6LC1-B |
| RJ45-6L1-S   | RJ45-8L1-S   | RJ45-6L1-B  |
| RJ45-8LCT1-S | RJ45-8LCT1-B | RJ45-8L1-B  |

RJ45 - PC Board Layout



For all RJ45 L, LC, LCT and X Series Models  
Shown from Component Side

All tolerances ± 0.010 [0.25] unless otherwise noted

Model Dimensions (continued)

L, LC, LCT and X Series RJ Jack Dimensions (continued)

RJH - No Shield



RJH - PC Board Layout



N and Z Series RJ Jack Dimensions

RJ11 - Low Profile, No Shield



RJ11 Low Profile, Style 3 Shield



All tolerances  $\pm 0.010$  [0.25] unless otherwise noted

Model Dimensions (continued)

N and Z Series RJ Jack Dimensions (continued)

RJ11 Low Profile, Style 4 Shield



Part No.

|            |          |
|------------|----------|
| RJ11-6N4-B | RJ11-6Z4 |
|------------|----------|

RJ45 - Low Profile, No Shield

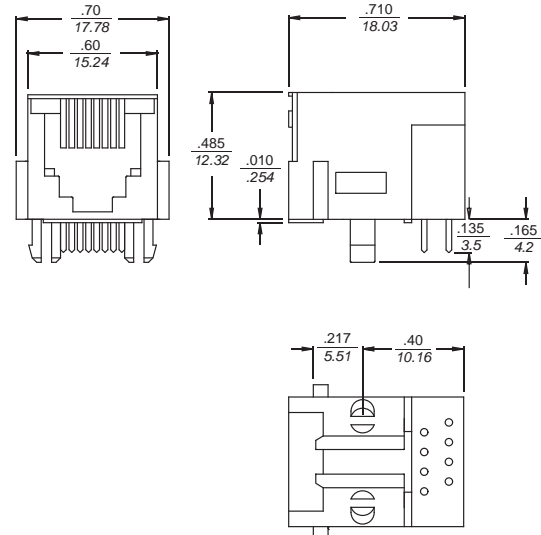

Part No.

|           |           |         |
|-----------|-----------|---------|
| RJ45-8N-B | RJ45-8N-S | RJ45-8Z |
|-----------|-----------|---------|

RJ11 Low Profile, PC Board Layout



For all RJ11 N and Z Series Models  
Shown from Component Side

RJ45 - Low Profile, Style 3 Shield

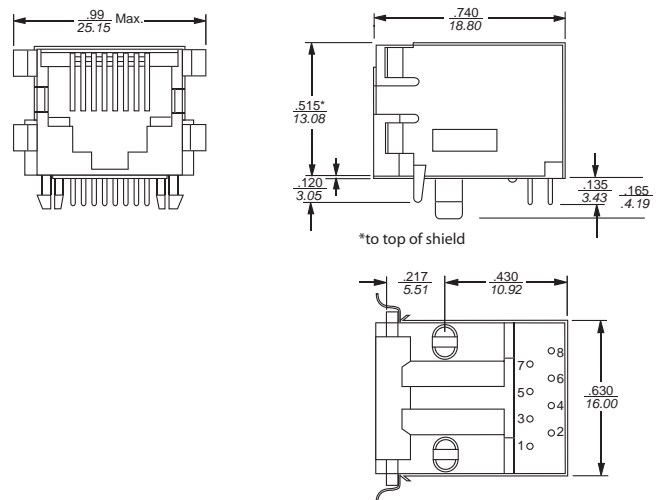

Part No.

|            |            |          |
|------------|------------|----------|
| RJ45-8N3-B | RJ45-8N3-S | RJ45-8Z3 |
|------------|------------|----------|

All tolerances ± 0.010 [0.25] unless otherwise noted

**Model Dimensions** *(continued)*

**N and Z Series RJ Jack Dimensions** *(continued)*

**RJ45 Low Profile, Style 4 Shield**



Part No.

|            |            |          |
|------------|------------|----------|
| RJ45-8N4-B | RJ45-8N4-S | RJ45-8Z4 |
|------------|------------|----------|

**RJ45 Low Profile PC Board Layout**



For all RJ45 N and Z Series Models  
Shown from Component Side

All tolerances  $\pm 0.010$  [0.25] unless otherwise noted

---

**Engineering Notes**

---



---

## 7. Technical Notes — Table of Contents

---

|   |     |
|---|-----|
| Introduction .....                                      | 262 |
| Understanding RFI Power Line Filters .....              | 263 |
| Understanding Hipot Testing .....                       | 266 |
| Understanding Leakage Current (Touch Current) .....     | 267 |
| Understanding Insertion Loss .....                      | 268 |
| Appendix A - Conducted RFI Emissions Testing .....      | 269 |
| Appendix B - Conducted RFI Susceptibility Testing ..... | 270 |
| Appendix C - Health Care Equipment .....                | 270 |
| Appendix D - Safety Agency File Numbers .....           | 271 |

## Introduction



TE Connectivity (TE) has established itself as a world leader in RFI technology by introducing the first line of catalog filter products over 50 years ago. Today, TE continues to pursue the latest in RFI filter design through testing and evaluating power supplies and studying their effects.

Changing international standards obligate designers to constantly review and evaluate their filtering needs. The following section provides some basic information on RFI terminology and filter selection.

Additional information can be accessed through TE's Corcom product internet pages at [www.corcom.com](http://www.corcom.com)



## Understanding RFI Power Line Filters

### What Is Radio Frequency Interference (RFI)?

RFI is unwanted electromagnetic energy in the frequency range generally used for radio communications. The frequency ranges of interest are 10kHz to 30MHz for conducted phenomena and 30MHz to 1GHz for radiated phenomena.

### What are the modes of propagation of RFI?

RFI is propagated via radiation (electromagnetic waves in free space) and by conduction over signal lines and AC power systems.

**Radiated** - One of the most significant contributors to radiated RFI from electronic equipment is the AC power cord. The power cord is often an efficient antenna since its length approaches a quarter wave length for the RFI frequencies present in digital equipment and switching power supplies.

**Conducted** - RFI is conducted over the AC power system in two modes. Common mode (asymmetrical) RFI is present on both the line and neutral current paths with reference to the ground or earth path. Differential mode (symmetrical) RFI is present as a voltage between the line and neutral leads.

### Why Be Concerned with RFI?

The designers and manufacturers of digital equipment must concern themselves with RFI for two reasons. (1) Their equipment must operate properly in the application environment, often in the presence of significant levels of RFI. (2) Their equipment must not emit RFI that interferes with RF communications often vital to health and safety. The necessity for reliable RF communications has given rise to legal regulations ensuring RFI control for electronic equipment.

### What are the FCC requirements?

The U.S. Federal Communications Commission (FCC) has established regulations to reduce the interference potential of electronic computing devices (FCC Rules, Part 15, Subpart J). A computing device is defined as any electronic device or system that generates and uses timing signals or pulses at a rate in excess of 10,000 per second and that uses digital techniques. It is important to note that a switching power supply does not itself fall into this category, but that its emissions must still meet the limits when it is installed in a piece of equipment that is subject to the regulations.

The level of emissions the equipment must meet depends on whether it is marketed for use in a residential environment (Class B) or in a commercial, industrial, or business environment (Class A). The limits for Class B are more stringent than those for Class A (see Appendix A). Most Class B equipment must undergo certification, meaning that emissions

test data must be submitted to the FCC for type approval. Class A and all other Class B equipment must be verified—i.e. the manufacturer conducts his own emissions testing and verifies that he complies with the limits, but no forms need to be filed with the FCC.

Further details on FCC requirements can be obtained from the FCC, RF Devices Branch (Authorization and Standards Division), Washington, DC 20554, (301) 725-1585.

### What are CE markings and RFI filters?

As of January 1, 1996, electrical and electronic equipment shipped to Europe is required to be labeled with the CE marking. In order to apply the CE marking, equipment must meet the General Product Safety Directive and Electromagnetic Compatibility Directive.

RFI power line filters are components and therefore not covered by the CE requirements, but they are used in electronic systems to meet EMC specifications.

Two of the most common emission specifications are EN 55011 for industrial, science, and medical equipment, and EN 55022 for information technology equipment. The conducted emission limits for these specifications are the same and broken down to Class "A" and Class "B" limits. Electronic equipment that may be connected to a power main shared with a residential area must comply with the more stringent Class "B" limits. The measurement technique is done using quasi-peak and average detection, with different limits for each measure in dB above one microvolt.

There are several immunity tests to which electronic equipment must comply, one of which is the electrically fast transient (EFT), IEC 61000-4-4. The equipment must continue to operate during this test. The transient wave form is a 5ns rise time with a 50ns duration. A burst is induced onto the power line at 1kV with a repetition rate of 5kHz lasting 15ms and repeated every 300ms. The test simulates switching of inductive loads and contacts.

To pass the EFT test, it is important that the RFI filter's enclosure have a good RF ground with the system's chassis ground. This provides a lower impedance path from the safety ground to the system ground. The shielding effect of the RFI filter's metal enclosure eliminates radiation into the system's cabinet induced by the conducted EFT burst. Stray capacitance may occur from any of the three input power wires to chassis ground where voltage can build up from the EFT burst and cause system interrupts. The RFI filter's inductor offers an impedance to the burst.

**Understanding RFI Power Line Filters** *(continued)*

In cases where the stray capacitances have caused multiple RF ground planes or where plastic enclosures are used, an inductive choke may be needed to provide isolation of the safety ground from the chassis ground.

**What Is a Power Line Interference Filter?**

A power line interference filter is a primary tool available to the designer of electronic equipment to control conducted RFI both into the equipment (potential equipment malfunction) and out of the equipment (potential interference to other system elements or RF communication). By controlling the RFI conducted onto the power cord, a power line filter also contributes significantly to the amount of radiated RFI.

A power line filter is a multiple-port network of passive components arranged as a dual low-pass filter; one network for common mode attenuation, another network for differential mode attenuation. The network provides attenuation of RF energy in the stopband of the filter (typically above 10kHz), while passing the power current (50-60Hz) with little or no attenuation.

**How Does a Power Line Interference Filter Work?**

Power line interference filters, as passive, bilateral networks, have complex transfer characteristics, which are extremely dependent upon source and load impedance. The magnitude of this transfer characteristic describes the attenuation performance of the filter. In the power line environment, however, the source and load impedances are not defined. Therefore the industry has standardized upon the practices of verifying filter uniformity through measurement of attenuation with 50 Ohm resistive source and load terminations. This measurement is defined to be the Insertion Loss (I.L.) of the filter.

$$I.L. = 10 \log \frac{P_L (Ref)}{P_L}$$

where  $P_L (Ref)$  is the power transferred from the source to the load without the filter, and  $P_L$  is the power transferred when a filter is inserted between the source and load. The Insertion Loss may also be expressed in terms of voltage or current ratios as shown:

$$I.L. = 20 \log \frac{V_L (Ref)}{V_L}$$

$$I.L. = 20 \log \frac{I_L (Ref)}{I_L}$$

where  $V_L (Ref)$  and  $I_L$  are measured without a filter and  $V_L$  and  $I_L$  are measured with a filter.

It is important to note that Insertion Loss does not describe the RFI attenuation provided by a filter in the power line environment. In the power line environment the relative magnitudes of the source and load impedances must be estimated and the appropriate filter configuration selected such that the greatest possible impedance mismatch occurs at each termination.

This dependence of filter performance on terminated impedances is the basis for the concept of "mismatching networks."

**What is the concept of power line filters as "Impedance Mismatching Networks"?**

RFI power line filters can be thought of as "impedance mismatching networks" at higher frequencies in the attenuation band. Network analysis shows that the greater the mismatch of filter impedance to terminating impedance, the more effective the filter is in attenuating RF energies.

Common mode power line impedance is considered to be low (on the order of 50 Ohms). Thus, following the concept of an impedance mismatch, Corcom power line filters employ a high common mode impedance (series inductance) on the power line side of the filter.

For load (equipment) side common mode impedance mismatch, Corcom products are available with a high impedance (series inductance) or a low impedance (shunt capacitance).

High (common mode) impedance filters for use with low impedance equipment include the EP, H, 6A Q, R and V series. Low (common mode) impedance filters for use with high impedance equipment include the B, EC, ED, EF, G, K, N, 3A Q, S, SK, T, W, X, Y, and Z series.

Knowing the input impedance of your equipment, then, may be useful in initially selecting the filter series most likely to solve your RFI problems. However, since this impedance is almost certainly complex (having both resistive and reactive components), it may vary widely over the RFI frequency range. Hence a variety of series should be evaluated in your quest for the most effective filter in any one application.

**Do all filter networks with the same circuit and element values perform identically?**

All filter networks with the same circuit and element values do not perform identically. Element values are specified and measured at a single frequency (usually 1kHz). Filter performance is required over the entire frequency spectrum, not just at the frequency of component measurement. The type of component construction and method of incorporation into a filter are extremely important to filter performance.

**Understanding RFI Power Line Filters** *(continued)*

Figure 1 illustrates the high-frequency performance difference between the three leaded capacitor construction employed by TE and a conventional method of construction. Both units would be specified by the same nominal 1kHz component value, approximately 5000pF.

**Figure 1: Insertion Loss**



**How Do You Select a Power Line Interference Filter?**

The only way to select and qualify a power line interference filter is to test the unit in your equipment. As mentioned above, the performance is highly dependent on equipment load impedance. Filter performance cannot be derived from single impedance (50 Ohm) insertion loss data. Performance is a complex function of filter element impedances and equipment impedances which vary in magnitude and phase over the frequency spectrum of interest. Filter selection testing should be performed in your equipment to your required level of performance for both conducted emission control (FCC, VDE) and susceptibility control.

**How do you perform conducted emission tests?**

Conducted emission testing requires a quiet RF environment—usually a shielded enclosure—a line impedance stabilization network, and an RF voltage instrument such as a tuned receiver or a spectrum analyzer. Additional testing information is given in Appendix A. The RF ambient of the test environment should be at least 20 dB below the desired compliance limit for accurate results. The line impedance stabilization network (LISN) is required to establish a desired source impedance for the power line input. This is an important part of the test procedure, since this impedance directly affects the measured emission levels. The correct bandwidth for the measurement receiver is also a critical test parameter.

**How do you perform susceptibility testing?**

Susceptibility testing involves injection of noise onto the power input lines while monitoring the equipment for proper operation. Quantification of the noise levels to be found in the equipment environment is difficult at best. Through analysis of solutions to specific susceptibility problems, TE has developed recommended noise injection levels, which proved a high level of confidence for reliable equipment operation in the real world environment. The test methods and injection noise levels are found in Appendix B.

**Is installation important to filter performance?**

Mounting and wiring of the filter are critical influences on its performances. A power line filter is best installed at the power line input point of your equipment. The filter is a barrier to high frequency signals. Its purpose must not be defeated by stray capacitance coupling the power input leads to the power output leads, or to any other conductors in the protected equipment.

Normally the case of the filter is bolted to the framework or chassis of the electronic equipment it protects. The line side leads should be kept short and well separated from the load side leads. The ideal isolation system is a bulkhead-mounted filter incorporating a line cord connector, such as the Corcom EC, ED, or EF power line filter series.

**How Do You Know Which Filter To Test?**

A filter, or ordered group of filters, likely to solve your interference control problem can be obtained by using the selector chart at the front of each section. Every Corcom filter series is available in a range of current ratings and packages. Detailed specifications, including prices, are listed on the individual series' catalog sheets referenced in the selector chart. Telephone numbers of distributors who stock all TE products are listed on the back cover of this catalog.

**Why Be Concerned with Safety Agency Requirements?**

All components in the AC power system, including power line filters, must be safe from potential fire and shock hazard. The standards set by the various safety agencies, like UL, CSA, VDE, and SEV, provide guidelines to assist the designer in specifying safe and reliable components. Components which carry the compliance symbols from these agencies have been designed and manufactured to comply with these standards. A summary of safety agency requirements can be found in Appendix C.

## Understanding RFI Power Line Filters *(continued)*

### What are the significant requirements of UL and CSA?

UL and CSA are primarily concerned with high potential withstand capability, temperature rise, creepage distances, and material temperature capability at the time of manufacture.

### What are the additional aspects of VDE safety requirements?

In addition to the requirements of UL and CSA, VDE specifies limits of hipot, insulation resistance, and change of component values, at the conclusion of extreme environmental conditioning. The conditioning includes life tests at elevated temperatures, long term humidity, and temperature/humidity cycling. Components that bear the VDE symbol of safety have been designed and tested not only for initial safety but also for safety over the life of the product.

### How Do You Specify a Power Line Filter?

The filter you have selected through system testing can best be specified by the data parameters found on the appropriate catalog page. Combining the product family parameters listed under the “specifi-

cations” with the package style and dimensional data from your specific filter will adequately define your selection.

### Are there other parameters that need to be specified?

There are three additional requirements that are often specified. Below are our recommended values:

1. Insulation Resistance: 6000 M $\Omega$  @ 100VDC
2. Current Overload: 6 X rated current for 8 seconds
3. Humidity: 21 days at 40°C 95% RH

### What are the test methods for verification of the important specification parameters?

Some filter specifications may be unfamiliar to you or may require slightly different measuring techniques than you have been using for other components. It is very important that supplier and customer use the same techniques for verification of electrical specifications, in order to assure an uninterrupted flow of quality components. Three specifications that must be clearly understood are hipot testing, leakage current, and insertion loss.

## Understanding Hipot Testing

The term “hipot” is an acronym for “high potential.” Hipot testing stresses the insulation and capacitors of a filter assembly by applying a voltage much higher than is usually experienced in normal operation. The purpose of hipot specifications is to assure safety and reliability.

All the major safety agencies require hipot testing for qualification of power line filters, and also require that each production unit undergo hipot testing to verify the integrity of the line-to-ground components and insulation. Every Corcom filter is hipot tested twice: once during assembly and again after completion. Applying hipot testing as an incoming inspection procedure requires a thorough understanding of its uses and limitations.

Hipot test voltages are applied from each line (both lines tied together for VDE) to ground and from line-to-line. The line-to-ground voltages are always higher. Test voltages may be specified as AC or DC, with the DC voltages at least 1.414 times the AC voltages.

For incoming inspection testing, TE recommends using the voltages given as “hipot rating” for each filter in the catalog. These DC voltages will always be equal to or higher than the peak AC voltage carried by any safety agency whose approval the filter carries. A DC hipot test is generally used.

A variety of hipot testers is available from a number of manufacturers. The tester chosen should have at

least a 500VA rating.

The following precautions must be observed to insure the safety of the operator and the validity of the test:

1. THESE VOLTAGES CAN BE LETHAL—use the utmost safety precautions to protect the test operator.
2. The possibility of high surge currents and oscillatory overvoltage during sudden application of the test voltage requires some method of limiting the applied current or increasing the voltage comparatively slowly.
3. For AC hipot tests, use an oscillograph to monitor the applied voltage. The current limiting circuit may react with the filter circuit to distort the 60Hz waveform. This may produce a peak voltage that exceeds the expected peak value of a sinusoidal voltage having the specified rms value. The peak voltage should be 1.414 times the rms value. Higher voltages may cause unwarranted failures due to the peak currents exceeding the trip setting.
4. For line-to-line hipot testing, remember that most filters have a bleeder resistor (typical value 100k $\Omega$  to 10M $\Omega$ ) to discharge the line-to-line capacitors. Be sure to set the trip point of the hipot tester above the current level that will flow through the bleeder resistor: 10mA is usually a safe value.

**Understanding Leakage Current (Touch Current)**

Leakage current (also referred to as “touch current”) is an important specification of power line filters. There has always been an undeserved negative connotation to this term. Leakage current is not a function of the quality of components, but is a direct function of the line-to-ground capacitance value. The larger the capacitance, the lower the impedance to common mode currents, and the greater the common mode interference rejection. Hence, leakage current is a measure of filter performance—the higher, the better.

Why, then, do safety agencies specify a maximum allowable leakage current? This is done in order to limit the magnitude of expected ground return currents. The line-to-ground capacitors provide a path for 50/60Hz current to flow to the chassis. As long as the equipment is grounded, these currents will flow in the ground circuit and present no hazard. However, in the unlikely but always possible circumstance where the ground circuit is faulty, the earth connection may be established by the body of a person. If this should occur, the maximum leakage current specification limits the ground return current to a safe value, typically 0.5 to 5.0mA. The limits set by safety agencies are based on end user equipment specifications, such as those given below.

**Capacitive Current Limits**

| <u>Country</u> | <u>Specification</u> | <u>Limits for Class I Grounded Equipment</u> |
|----------------|----------------------|--|
| U.S.A.         | UL 60950             | 3.5 mA, 120V, 60Hz                           |
| Canada         | C22.2 No. 60950      | 3.5 mA, 120V, 60Hz                           |
| Europe         | EN 60950             | 3.5 mA, 250V, 50Hz                           |

Since the largest component of leakage current is usually from the power line filter, it is prudent to set a maximum leakage current limit for the filter itself. There has been a tendency in the industry to specify the minimum leakage current to comply with all agency requirements, usually 0.5mA. This specification decision should not be made arbitrarily, because often the size and cost of the filter can be reduced by allowing a greater maximum leakage current.

**Figure 2: Leakage Current Measurement**



*Note that filter case must be floating, not grounded.*

The circuit of Figure 2 illustrates the measurement technique for leakage current. The leakage limits apply to each side of the line independently. The test circuit provides the correct value by shunting the line-to-ground path that is not being measured by the millimeter impedance. This test is realistic, because power to a system is provided by a hot line and a neutral line, with the neutral basically at ground potential, thus providing no addition to the leakage.

Note that the leakage current is directly proportional to line voltage and frequency. Hence, it is unwise to specify an operation frequency greater than 60Hz (e.g., 400Hz) when leakage current limits must also be met.

**Understanding Insertion Loss**

**What is insertion loss?**

Insertion loss is the ratio (expressed in dB) of the signal voltage transferred from source to load without a filter, to the signal voltage transferred from source to load when the filter is inserted. As discussed above (“How Does a Power Line Interference Filter Work?”), insertion loss is not a measure of filter performance in the power line equipment environment.

**How is it measured?**

If the terminating impedances are standardized, then it becomes meaningful to measure insertion loss, but the results so obtained can be applied only to an identical circuit. The most popular set-up is to make the source and load impedances each 50 Ohms, resistive.

The most important aspect of insertion loss measurement is consistency. It is particularly critical that supplier and user employ the same measurement techniques. The standard method of insertion loss measurement used by TE is as follows:

Insertion loss is easily measured with a spectrum analyzer or tuned receiver and a tracking generator. A zero dB reference is established without the filter. Then the filter is inserted, and the attenuation provided over the desired frequency range is recorded.

For a power line filter we are interested in signal attenuation in two different modes:

**Common Mode (CM)** — signals present on both sides of the line (hot and neutral) referenced to ground.

**Differential Mode (DM)** — signals present on one side of the line, referenced to the other.

Accordingly, we may deal with CM insertion loss or DM insertion loss or both.

For the common mode, the line and neutral terminals are at the same potential (same magnitude and phase) and may be considered as being in parallel. CM current circulates between this pair and the common (ground) lead. CM insertion loss is measured by strapping the line and neutral terminals together on both sides of the filter (Figure 3). All CM insertion loss data published in the Corcom product catalog are measured this way. For differential mode, the signals on the line and neutral terminals are of the same magnitude but opposite phase. Current circulates between the line and neutral leads only. DM insertion loss is tested with 50 Ohm 180° power splitters as shown in Figure 4. All DM insertion loss data published in the Corcom product catalog are measured this way.

**Figure 3: CM Insertion Loss Measurement**



For differential mode, the signals on the line and neutral terminals are of the same magnitude but opposite phase. Current circulates between the line and neutral leads only. DM insertion loss is tested with 50 Ohm 180° power splitters as shown in Figure 4. All DM insertion loss data published in the Corcom product guide are measured this way.

**Figure 4: DM Insertion Loss Measurement**



Note that all signal leads in Figures 3 and 4 are 50 Ohm coaxial cables.

1. Make your 0dB reference measurement over the entire frequency range, not just at one or two points.
2. Make sure the filter case has a good RF ground connection.
3. Make sure the wiring to the load side of the filter is well separated from the wiring to the line side, to avoid RF coupling around the filter.

**Understanding Insertion Loss** *(continued)*

**What can it be used for?**

Standardized insertion loss data will not accurately predict a filter’s performance in your equipment. However, it does serve as an important tool for verifying product consistency through incoming inspection.

The criterion for acceptance would be that the measured insertion loss must either meet or exceed the

published data when tested in the standardized manner.

Accordingly, “typical” insertion loss data is not meaningful. The data to which you test should be minimum values. Most of the insertion loss data published by TE are guaranteed minimums, and as such can be tested for a positive indication of component consistency.

**Appendix A - Conducted RFI Emissions Testing**

**Conducted RFI Emissions Testing**

Since conducted emissions testing is usually done to insure that your equipment will comply with the limits of FCC Part 15 or EN55022, the test methods used should conform to the specifications of these two agencies. You will need the following equipment:

1. Shielded room, to allow measurement with minimal background interference.
2. Two 50 Ohm line impedance stabilization networks (LISNs), fixing the line-side impedances as mandated by FCC and CISPR.
3. Spectrum analyzer or tuned receiver, with CISPR quasipeak detector, covering the range from 10kHz to 30MHz.

**Figure A2**



**Figure A1**



The limits for FCC Part 15 and EN55022 are shown in Figure A2. To which one or more of these limits you will test is determined by whether your equipment is marketed in the United States (FCC) or Europe (EN55022) and into which class of operation it falls at each agency.

## Appendix B - Conducted RFI Susceptibility Testing

### Conducted RFI Susceptibility Testing

You can determine whether or not your equipment is susceptible to conducted RFI by subjecting it to predetermined levels of CM and DM interferences, and noting any malfunctions that occur. Such a test approximates real-world interference by standardized test conditions, according to previous experience. TE's recommendation for conducted susceptibility testing follows. The equipment required will be:

1. Shielded room, to eliminate spurious signals.
2. Two 50 Ohm line impedance stabilization networks (LISNs).
3. 50 Ohm signal generator, 1 Watt output.
4. 50 Ohm (or less) pulse generator, 0 to 300 Volts output.

CW signals should be injected common-mode, using peak levels of:

- 7 Volts from 10kHz to 150kHz
- 2 Volts from 150kHz to 500kHz
- 1 Volt from 500kHz to 30MHz

Pulse waveforms should be injected common mode and differential mode, pulse width 10 microseconds, rise time 1 microsecond, repetition rate 60Hz and varied in phase 0 to 360 degrees on the 60Hz power waveform. CM pulses should have peak levels of 2 volts; DM pulses should have peak levels of twice the rated line voltage.

These levels are based on emission data gathered at TE and are considered typical of the levels encountered close to high noise sources.

Figure A3

#### A. Common Mode



#### B. Differential Mode



## Appendix C - Health Care Equipment

### UL 60601-1 Medical Electrical Equipment

The major safety standard for electro-medical devices is the IEC 60601 series, with the IEC 60601-1 standard covering all generic requirements. This standard is the basis of the various harmonized equivalents, the European equivalent is EN 60601, the UL equivalent is UL60601-1 and the CSA equivalent is C22.2 No. 60601-1

Underwriters Laboratories' medical electrical equipment specification is broken down into two basic categories.

**A. Patient Care Equipment:** "Equipment that is intended to be used on or with, or likely to be contacted by, a patient in a health care facility in the course of his treatment." This equipment can have a maximum leakage current of 100  $\mu$ A at 120VAC, 60Hz.

**B. Non-patient Equipment:** "Equipment primarily for use in a health care facility that is intended for use where contact with a patient is unlikely." This equipment can have a maximum leakage current of 300  $\mu$ A at 120VAC, 60Hz.

All filters starting with "H" and "M" are for medical equipment applications. They can be used in both patient care equipment and non-patient equipment. All other Corcom products with an "E" in the part number are suitable for use only in (120V) non-patient equipment.



**Appendix D - Safety Agency File Numbers**

**Filters**



**UL Recognition**

Guide FOKY2, File E48570  
*All except IK series*  
Guide ECBT2, File E106884  
*Non-filtered DB Series connectors only*



**Component Recognized by UL to Canadian Requirements**

Guide ECBT8, File E106884  
*Non-filtered DB Series connectors only*



**Component Recognized by UL to Canadian Requirements**

UL Guide FOKY2, File E48570  
CSA Guide FOKY8, File E48570  
*AFC, FFA, FFD and DFC Series only*



**UL Listing**

Guide FNFT, File E117533  
*Model 3FL3 ballast filter*



**CSA Certification**

Class 2221, File LR46870  
*All except IK series*



**VDE Approval**

File 706400-4730  
*All except IK series*



**TUV Approval**

File E2173035  
*DAF, DAS Series*  
File E2173028.01  
*DCB, DCF Series*  
File T72091763.01  
*Filtered DB Series*  
File T72081913.01  
*Non-filtered DB Series (Connectors)*

**Signal Sentry Modular Jacks**



**UL Recognition**

Guide DUXR2, File E136872



**CSA Certification**

Class 4872, File LR96220

**Power Entry Modules**



**UL Recognition**

Guide FOKY2, File E48570  
*All filtered power entry modules*  
Guide AXUT2, File E61290  
*All non-filtered fuseless modules and 15SRB with suffix 1, 2, 8, P, S1 or S8*  
Guide AYVZ2, File E59193  
*All non-filtered fused modules*



**Component Recognized by UL to Canadian Requirements**

Guide AXUT8, File E61290  
*Models: 15CE1, 15CS1, 15CBE1, 15CBS1 and 15CU Series*



**CSA Certification**

Class 2221, File LR46870  
*Filtered modules*  
Class 6221, File LR68190  
*Non-filtered modules*



**TUV Approval**

File T72051210.01  
*Non-filtered DC rated P Series with VDE rating only*



**VDE Approval**

File 706400-4730  
*All filtered modules except J Series*  
File 706400-1550  
*All non-filtered modules except J Series*

**Accessories**



**UL Recognition**

Guide ECBT2, File E106884  
*MA100*  
Guide XUHT2 File E106794  
*TS Series*



**CSA Certification**

Class 6233, File LR88865  
*MA100*

---

**Engineering Notes**

---



**Part Number Index and Cross Reference**

| Catalog Number | TE Ordering Number | Page Number | Catalog Number | TE Ordering Number | Page Number |
|----------------|--------------------|-------------|----------------|--------------------|-------------|
| 1CFE1          | 6609113-1          | 130         | 1EGG8C-2       | 6609115-9          | 166         |
| 1CFS1          | 6609113-2          | 130         | 1EGS1-1        | 6609117-1          | 166         |
| 1CHE1          | 6609114-1          | 130         | 1EGS1-2        | 6609117-2          | 166         |
| 1CHS1          | 6609114-2          | 130         | 1EHG1-2        | 6609116-1          | 166         |
| 1CUFE1         | 2-1609113-2        | 134         | 1EHG8-2        | 1-1609117-4        | 166         |
| 1CUFF1         | 2-1609114-2        | 134         | 1EHGS1-2       | 1609988-1          | 166         |
| 1CUFS1         | 2-1609113-7        | 134         | 1EJH1          | 6609008-1          | 154         |
| 1EAH1          | 6609002-1          | 149         | 1EJH2          | 6609008-6          | 154         |
| 1EAS1          | 6609005-6          | 149         | 1EJH8          | 2-6609008-8        | 154         |
| 1EB1           | 6609020-1          | 15          | 1EJHP          | 6609008-7          | 154         |
| 1EB3           | 6609020-2          | 15          | 1EJHS1         | 1-6609008-6        | 154         |
| 1EBF1          | 6609018-1          | 138         | 1EJHS8         | 2-6609008-2        | 154         |
| 1EBF4          | 6609018-2          | 138         | 1EJM1          | 6609985-1          | 154         |
| 1EBH1          | 6609003-1          | 149         | 1EJM8          | 1-6609985-3        | 154         |
| 1EBP           | 6609063-1          | 21          | 1EJMS1         | 6609985-7          | 154         |
| 1EBS1          | 1-6609005-1        | 149         | 1EJMS8         | 1-6609985-8        | 154         |
| 1EC1           | 6609017-1          | 141         | 1EJS1          | 6609006-4          | 154         |
| 1EC2           | 6609017-2          | 141         | 1EJS8          | 3-6609006-7        | 154         |
| 1EC4           | 6609017-3          | 141         | 1EJT1          | 2-6609006-1        | 163         |
| 1EC8           | 6609017-4          | 141         | 1EJT8          | 2-6609006-6        | 163         |
| 1ED1           | 6609016-1          | 144         | 1EK1           | 6609027-1          | 49          |
| 1ED2           | 6609016-2          | 144         | 1EK3           | 6609027-2          | 49          |
| 1ED4           | 6609016-3          | 144         | 1EOP           | 6609064-1          | 21          |
| 1ED8           | 6609016-4          | 144         | 1ER1           | 6609031-1          | 61          |
| 1EDK1          | 6609033-1          | 18          | 1ER3           | 6609031-2          | 61          |
| 1EDK3          | 6609033-2          | 18          | 1EZP           | 6609062-1          | 92          |
| 1EDP           | 6609065-1          | 21          | 1IK1C          | 1-6609085-1        | 46          |
| 1EEA1          | 6609000-1          | 149         | 1VB1           | 6609021-1          | 15          |
| 1EEA2          | 6609000-2          | 149         | 1VB3           | 6609021-2          | 15          |
| 1EEAP          | 6609000-3          | 149         | 1VDK1          | 6609034-1          | 18          |
| 1EEB1          | 6609001-1          | 149         | 1VDK3          | 6609034-2          | 18          |
| 1EEB2          | 6609001-2          | 149         | 1VK1           | 6609028-1          | 49          |
| 1EEBP          | 6609001-3          | 149         | 1VK3           | 6609028-2          | 49          |
| 1EEJ1          | 6609006-1          | 154         | 1VR1           | 6609032-1          | 61          |
| 1EEJ2          | 6609006-2          | 154         | 1VR3           | 6609032-2          | 61          |
| 1EEJ8          | 3-6609006-2        | 154         | 2EB1           | 6609020-3          | 15          |
| 1EEJP          | 6609006-3          | 154         | 2EB3           | 6609020-4          | 15          |
| 1EF1F          | 6609015-1          | 160         | 2EDL1S         | 6609122-1          | 176         |
| 1EF2F          | 6609015-2          | 160         | 2EDL1SC        | 6609122-2          | 176         |
| 1EF4           | 6609014-3          | 160         | 2EDL1SCM       | 6609122-3          | 176         |
| 1EF8           | 6609014-4          | 160         | 2EDL1SM        | 6609122-4          | 176         |
| 1EGG1-1        | 6609115-1          | 166         | 2EDL4          | 6609122-5          | 176         |
| 1EGG1-2        | 6609115-3          | 166         | 2EDL4C         | 6609122-7          | 176         |
| 1EGG1C-1       | 6609115-4          | 166         | 2EDL4CM        | 6609122-9          | 176         |
| 1EGG1C-2       | 6609115-5          | 166         | 2EDL4M         | 1-6609122-0        | 176         |
| 1EGG8-1        | 6609115-6          | 166         | 2EK1           | 6609027-3          | 49          |
| 1EGG8-2        | 6609115-7          | 166         | 2EK3           | 6609027-4          | 49          |
| 1EGG8C-1       | 6609115-8          | 166         | 2ER1           | 1609031-3          | 61          |

**Part Number Index and Cross Reference**

| Catalog Number | TE Ordering Number | Page Number | Catalog Number | TE Ordering Number | Page Number |
|----------------|--------------------|-------------|----------------|--------------------|-------------|
| 2ER3           | 6609031-4          | 61          | 3EEJ2          | 6609006-6          | 154         |
| 2EYP           | 6609061-2          | 92          | 3EEJ8          | 3-6609006-3        | 154         |
| 2EZP           | 6609062-2          | 92          | 3EEJP          | 6609006-7          | 154         |
| 2RJ11-6L-B     | 3-6609208-6        | 248         | 3EF1F          | 6609015-3          | 160         |
| 2VB1           | 6609021-3          | 15          | 3EF2F          | 6609015-4          | 160         |
| 2VB3           | 6609021-4          | 15          | 3EF4           | 6609014-7          | 160         |
| 2VK1           | 6609028-3          | 49          | 3EF8           | 6609014-8          | 160         |
| 2VK3           | 6609028-4          | 49          | 3EGG1-1        | 1-6609115-1        | 166         |
| 2VR1           | 6609032-3          | 61          | 3EGG1-2        | 1-6609115-2        | 166         |
| 2VR3           | 6609032-4          | 61          | 3EGG1C-1       | 1-6609115-3        | 166         |
| 3AYO1          | 6609066-1          | 111         | 3EGG1C-2       | 1-6609115-5        | 166         |
| 3CFE1          | 6609113-5          | 130         | 3EGG8-1        | 1-6609115-7        | 166         |
| 3CFS1          | 6609113-6          | 130         | 3EGG8-2        | 1-6609115-8        | 166         |
| 3CHE1          | 6609114-5          | 130         | 3EGG8C-1       | 1-6609115-9        | 166         |
| 3CHS1          | 6609114-6          | 130         | 3EGG8C-2       | 2-6609115-0        | 166         |
| 3CUFE1         | 2-1609113-3        | 134         | 3EGS1-1        | 6609117-3          | 166         |
| 3CUFF1         | 2-1609114-3        | 134         | 3EGS1-2        | 6609117-4          | 166         |
| 3CUFS1         | 2-1609113-8        | 134         | 3EH1           | 6609012-1          | 169         |
| 3DAF1          | 6609075-4          | 212         | 3EH3           | 6609012-2          | 169         |
| 3DAFP          | 6609075-3          | 212         | 3EHG1-2        | 6609116-2          | 166         |
| 3DAS1          | 1-6609075-7        | 212         | 3EHG8-2        | 1-1609117-5        | 166         |
| 3EAH1          | 6609002-2          | 149         | 3EHGS1-2       | 1609988-2          | 166         |
| 3EAS1          | 6609005-7          | 149         | 3EHQ1          | 6609054-1          | 37          |
| 3EB1           | 6609020-5          | 15          | 3EHQ3          | 6609054-2          | 37          |
| 3EB3           | 6609020-6          | 15          | 3EHQ8          | 6609054-3          | 37          |
| 3EBF1          | 6609018-3          | 138         | 3EHQ8M         | 6609054-4          | 37          |
| 3EBF4          | 6609018-4          | 138         | 3EHQ8M         | 6609054-4          | 37          |
| 3EBH1          | 6609003-2          | 149         | 3EHT1          | 6609053-1          | 40          |
| 3EBP           | 6609063-2          | 21          | 3EHT3          | 6609053-2          | 40          |
| 3EBS1          | 1-6609005-2        | 149         | 3EHT7          | 6609053-3          | 40          |
| 3EC1           | 6609017-5          | 141         | 3EHT7M         | 6609053-4          | 40          |
| 3EC2           | 6609017-6          | 141         | 3EHZ1          | 6609055-1          | 43          |
| 3EC4           | 6609017-7          | 141         | 3EJH1          | 6609008-2          | 154         |
| 3EC8           | 6609017-8          | 141         | 3EJH2          | 6609008-8          | 154         |
| 3ED1           | 6609016-5          | 144         | 3EJH8          | 2-6609008-9        | 154         |
| 3ED2           | 6609016-6          | 144         | 3EJHP          | 6609008-9          | 154         |
| 3ED4           | 6609016-7          | 144         | 3EJHS1         | 1-6609008-7        | 154         |
| 3ED8           | 6609016-8          | 144         | 3EJHS8         | 2-6609008-3        | 154         |
| 3EDK1          | 6609033-3          | 18          | 3EJM1          | 6609985-2          | 154         |
| 3EDK3          | 6609033-4          | 18          | 3EJM8          | 1-6609985-4        | 154         |
| 3EDP           | 6609065-2          | 21          | 3EJMS1         | 6609985-8          | 154         |
| 3EEA1          | 6609000-4          | 149         | 3EJMS8         | 1-6609985-9        | 154         |
| 3EEA2          | 6609000-5          | 149         | 3EJS1          | 6609006-8          | 154         |
| 3EEAP          | 6609000-6          | 149         | 3EJS8          | 3-6609006-8        | 154         |
| 3EEB1          | 6609001-4          | 149         | 3EJT1          | 2-6609006-2        | 163         |
| 3EEB2          | 6609001-5          | 149         | 3EJT8          | 2-6609006-7        | 163         |
| 3EEBP          | 6609001-6          | 149         | 3EK1           | 6609027-5          | 49          |
| 3EEJ1          | 6609006-5          | 154         | 3EK3           | 6609027-6          | 49          |

**Part Number Index and Cross Reference**

| Catalog Number | TE Ordering Number | Page Number | Catalog Number | TE Ordering Number | Page Number |
|----------------|--------------------|-------------|----------------|--------------------|-------------|
| 3EK7           | 6609027-7          | 49          | 3VK3           | 6609028-6          | 49          |
| 3EK7M          | 6609027-8          | 49          | 3VK7           | 6609028-7          | 49          |
| 3EMC1          | 1-6609037-1        | 24          | 3VK7M          | 6609028-8          | 49          |
| 3EMC3          | 1-6609037-8        | 24          | 3VQ1           | 6609049-1          | 58          |
| 3EOP           | 6609064-2          | 21          | 3VQ3           | 6609049-2          | 58          |
| 3EP1           | 6609037-1          | 27          | 3VQ8           | 6609049-3          | 58          |
| 3EP3           | 6609037-2          | 27          | 3VQ8M          | 6609049-4          | 58          |
| 3EP7           | 6609037-3          | 27          | 3VR1           | 6609032-5          | 61          |
| 3EP7M          | 6609037-4          | 27          | 3VR3           | 6609032-6          | 61          |
| 3EQ1           | 6609048-1          | 58          | 3VR7           | 6609032-7          | 61          |
| 3EQ3           | 6609048-2          | 58          | 3VR7M          | 6609032-8          | 61          |
| 3EQ8           | 6609048-3          | 58          | 3VS1           | 6609042-1          | 68          |
| 3EQ8M          | 6609048-4          | 58          | 3VSK1          | 6609036-1          | 75          |
| 3ER1           | 6609031-5          | 61          | 3VSK3          | 6609036-2          | 75          |
| 3ER3           | 6609031-6          | 61          | 3VSK7          | 6609036-3          | 75          |
| 3ER7           | 6609031-7          | 61          | 3VSK7M         | 6609036-4          | 75          |
| 3ER7M          | 6609031-8          | 61          | 3VV1           | 6609043-1          | 86          |
| 3ERK1          | 1-1609036-7        | 65          | 3VW1           | 6609044-1          | 86          |
| 3ESK1          | 6609035-1          | 75          | 3VW1           | 6609044-1          | 86          |
| 3ESK3          | 6609035-2          | 75          | 4EDL1S         | 1-6609122-1        | 176         |
| 3ESK7          | 6609035-3          | 75          | 4EDL1SC        | 1-6609122-2        | 176         |
| 3ESK7M         | 6609035-4          | 75          | 4EDL1SCM       | 1-6609122-3        | 176         |
| 3ET1           | 6609046-1          | 80          | 4EDL1SM        | 1-6609122-4        | 176         |
| 3ET3           | 6609046-2          | 80          | 4EDL4          | 1-6609122-5        | 176         |
| 3ET7           | 6609046-3          | 80          | 4EDL4C         | 1-6609122-6        | 176         |
| 3EX1           | 6609059-1          | 92          | 4EDL4CM        | 1-6609122-7        | 176         |
| 3EXLA2S        | 6609119-1          | 180         | 4EDL4M         | 1-6609122-8        | 176         |
| 3EXM1S         | 6609131-7          | 184         | 4EXP           | 6609060-4          | 92          |
| 3EXM4          | 6609131-8          | 184         | 4EYP           | 6609061-4          | 92          |
| 3EXM4S         | 6609131-9          | 184         | 4RJ11-6L-B     | 6609213-1          | 248         |
| 3EXP           | 6609060-3          | 92          | 5EB1           | 6609020-7          | 15          |
| 3EYP           | 6609061-3          | 92          | 5EB3           | 6609020-8          | 15          |
| 3EZ1           | 6609059-2          | 92          | 5EFLA2S        | 6609118-1          | 180         |
| 3EZLA2S        | 6609120-1          | 180         | 5EFM1          | 2-6609129-1        | 184         |
| 3EZM1S         | 6609132-8          | 184         | 5EFMIC         | 2-6609129-2        | 184         |
| 3EZM4          | 6609132-9          | 184         | 5EFM1S         | 2-6609129-3        | 184         |
| 3EZM4S         | 1-6609132-0        | 184         | 5EFM1SC        | 2-6609129-5        | 184         |
| 3EZP           | 6609062-3          | 92          | 5EFM4          | 2-6609129-6        | 184         |
| 3FL3           | 2-6609092-3        | 33          | 5EFM4C         | 2-6609129-7        | 184         |
| 3MV1           | 6609056-1          | 54          | 5EFM4S         | 2-6609129-8        | 184         |
| 3VAQ3          | 6609057-1          | 12          | 5EFM4SC        | 3-6609129-0        | 184         |
| 3VAQ8F         | 6609058-1          | 12          | 5EHM1          | 1-6609130-1        | 184         |
| 3VAQ8FS        | 6609058-2          | 12          | 5EHM1S         | 1-6609130-3        | 184         |
| 3VB1           | 6609021-5          | 15          | 5EHM4          | 1-6609130-4        | 184         |
| 3VB3           | 6609021-6          | 15          | 5EHM4S         | 1-6609130-5        | 184         |
| 3VDK1          | 6609034-3          | 18          | 5EK1           | 6609027-9          | 49          |
| 3VDK3          | 6609034-4          | 18          | 5EK3           | 1-6609027-0        | 49          |
| 3VK1           | 6609028-5          | 49          | 5EK7           | 1-6609027-1        | 49          |

**Part Number Index and Cross Reference**

| Catalog Number | TE Ordering Number | Page Number | Catalog Number | TE Ordering Number | Page Number |
|----------------|--------------------|-------------|----------------|--------------------|-------------|
| 5EK7M          | 1-6609027-2        | 49          | 6EDL1SM        | 2-6609122-2        | 176         |
| 5ER1           | 6609031-9          | 61          | 6EDL4          | 2-6609122-3        | 176         |
| 5ER3           | 1-6609031-0        | 61          | 6EDL4C         | 2-6609122-4        | 176         |
| 5ER7           | 1-6609031-1        | 61          | 6EDL4CM        | 2-6609122-5        | 176         |
| 5ER7M          | 1-6609031-2        | 61          | 6EDL4M         | 2-6609122-6        | 176         |
| 5VB1           | 6609021-7          | 15          | 6EDP           | 6609065-3          | 21          |
| 5VB3           | 6609021-8          | 15          | 6EEA1          | 6609000-7          | 149         |
| 5VK1           | 6609028-9          | 49          | 6EEA2          | 6609000-8          | 149         |
| 5VK3           | 1-6609028-0        | 49          | 6EEAP          | 6609000-9          | 149         |
| 5VK7           | 1-6609028-1        | 49          | 6EEB1          | 6609001-7          | 149         |
| 5VK7M          | 1-6609028-2        | 49          | 6EEB2          | 6609001-8          | 149         |
| 5VR1           | 6609032-9          | 61          | 6EEBP          | 6609001-9          | 149         |
| 5VR3           | 1-6609032-0        | 61          | 6EEJ1          | 6609006-9          | 154         |
| 5VR7           | 1-6609032-1        | 61          | 6EEJ2          | 1-6609006-0        | 154         |
| 5VR7M          | 1-6609032-2        | 61          | 6EEJ8          | 3-6609006-4        | 154         |
| 6AYO1          | 6609066-2          | 111         | 6EEJP          | 1-6609006-1        | 154         |
| 6CFE1          | 6609113-9          | 130         | 6EF1F          | 6609015-5          | 160         |
| 6CFS1          | 1-6609113-0        | 130         | 6EF2F          | 6609015-6          | 160         |
| 6CHE1          | 6609114-9          | 130         | 6EF4           | 1-6609014-1        | 160         |
| 6CHS1          | 1-6609114-0        | 130         | 6EF8           | 1-6609014-2        | 160         |
| 6CUFE1         | 2-1609113-4        | 134         | 6EG1           | 6609050-1          | 35          |
| 6CUFF1         | 2-1609114-4        | 134         | 6EGG1-1        | 2-6609115-2        | 166         |
| 6CUFS1         | 2-1609113-9        | 134         | 6EGG1-2        | 2-6609115-3        | 166         |
| 6DAF1          | 6609075-6          | 212         | 6EGG1C-1       | 2-6609115-4        | 166         |
| 6DAFP          | 6609075-5          | 212         | 6EGG1C-2       | 2-6609115-6        | 166         |
| 6DAS1          | 2-6609075-1        | 212         | 6EGG8-1        | 2-6609115-8        | 166         |
| 6EAH1          | 6609002-3          | 149         | 6EGG8-2        | 2-6609115-9        | 166         |
| 6EAS1          | 6609005-8          | 149         | 6EGG8C-1       | 3-6609115-0        | 166         |
| 6EBF1          | 6609018-5          | 138         | 6EGG8C-2       | 3-6609115-1        | 166         |
| 6EBF4          | 6609018-6          | 138         | 6EGS1-1        | 6609117-5          | 166         |
| 6EBH1          | 6609003-3          | 149         | 6EGS1-2        | 6609117-6          | 166         |
| 6EBS1          | 1-6609005-3        | 149         | 6EH1           | 6609012-3          | 169         |
| 6EC1           | 6609017-9          | 141         | 6EH3           | 6609012-4          | 169         |
| 6EC2           | 1-6609017-0        | 141         | 6EH4           | 6609013-1          | 169         |
| 6EC4           | 1-6609017-1        | 141         | 6EH5           | 6609013-4          | 169         |
| 6EC8           | 1-6609017-2        | 141         | 6EH8           | 6609013-3          | 169         |
| 6ED1           | 6609016-9          | 144         | 6EH9           | 6609013-2          | 169         |
| 6ED1C          | 1-6609016-1        | 144         | 6EHG1-2        | 6609116-3          | 166         |
| 6ED2           | 1-6609016-0        | 144         | 6EHG8-2        | 1-1609117-6        | 166         |
| 6ED4           | 1-6609016-2        | 144         | 6EHGS1-2       | 1609988-3          | 166         |
| 6ED4C          | 1-6609016-4        | 144         | 6EHL1S         | 6609123-1          | 176         |
| 6ED8           | 1-6609016-3        | 144         | 6EHL1SC        | 6609123-2          | 176         |
| 6ED8C          | 1-6609016-5        | 144         | 6EHL1SCM       | 6609123-3          | 176         |
| 6EDK1          | 6609033-5          | 18          | 6EHL1SM        | 6609123-4          | 176         |
| 6EDK3          | 6609033-6          | 18          | 6EHL4          | 6609123-5          | 176         |
| 6EDL1S         | 1-6609122-9        | 176         | 6EHL4C         | 6609123-6          | 176         |
| 6EDL1SC        | 2-6609122-0        | 176         | 6EHL4CM        | 6609123-7          | 176         |
| 6EDL1SCM       | 2-6609122-1        | 176         | 6EHL4M         | 6609123-8          | 176         |

**Part Number Index and Cross Reference**

| Catalog Number | TE Ordering Number | Page Number | Catalog Number | TE Ordering Number | Page Number |
|----------------|--------------------|-------------|----------------|--------------------|-------------|
| 6EHQ1          | 6609054-5          | 37          | 6ESRM-P        | 1609078-1          | 201         |
| 6EHQ3          | 6609054-6          | 37          | 6ET1           | 6609046-4          | 80          |
| 6EHQ8          | 6609054-7          | 37          | 6ET3           | 6609046-5          | 80          |
| 6EHT1          | 6609053-5          | 40          | 6ET7           | 6609046-6          | 80          |
| 6EHT3          | 6609053-6          | 40          | 6EU1           | 6609045-2          | 84          |
| 6EHT7          | 6609053-7          | 40          | 6EUP           | 6609045-1          | 84          |
| 6EHT7M         | 6609053-8          | 40          | 6EXP           | 6609060-6          | 92          |
| 6EJH1          | 6609008-3          | 154         | 6FC10          | 6609069-1          | 30          |
| 6EJH2          | 1-6609008-0        | 154         | 6FCD10         | 6609070-1          | 119         |
| 6EJH8          | 3-6609008-0        | 154         | 6HJ4-2         | 6609126-1          | 172         |
| 6EJHP          | 1-6609008-1        | 154         | 6HJ4-4         | 6609126-2          | 172         |
| 6EJHS1         | 1-6609008-8        | 154         | 6IK1           | 1609973-4          | 46          |
| 6EJHS8         | 2-6609008-4        | 154         | 6J4            | 6609125-1          | 172         |
| 6EJM1          | 6609985-3          | 154         | 6J4-2          | 6609125-2          | 172         |
| 6EJM8          | 1-6609985-5        | 154         | 6MV1           | 6609056-2          | 54          |
| 6EJMS1         | 6609985-9          | 154         | 6RJ11-6L-B     | 6609213-2          | 248         |
| 6EJMS8         | 2-6609985-0        | 154         | 6VAQ3          | 6609057-3          | 12          |
| 6EJS1          | 1-6609006-2        | 154         | 6VAQ8F         | 6609058-3          | 12          |
| 6EJS8          | 3-6609006-9        | 154         | 6VAQ8FS        | 6609058-4          | 12          |
| 6EJT1          | 2-6609006-3        | 163         | 6VDK1          | 6609034-5          | 18          |
| 6EJT8          | 2-6609006-8        | 163         | 6VDK3          | 6609034-6          | 18          |
| 6EL1S          | 6609121-1          | 176         | 6VG1           | 6609051-1          | 35          |
| 6EL1SC         | 6609121-2          | 176         | 6VJ1           | 6609124-1          | 172         |
| 6EL1SCM        | 6609121-3          | 176         | 6VJ1-2         | 6609124-2          | 172         |
| 6EL1SM         | 6609121-4          | 176         | 6VM1           | 2-6609128-6        | 184         |
| 6EL4           | 6609121-5          | 176         | 6VM1C          | 2-6609128-7        | 184         |
| 6EL4C          | 6609121-6          | 176         | 6VM1S          | 2-6609128-8        | 184         |
| 6EL4CM         | 6609121-7          | 176         | 6VM1SC         | 2-6609128-9        | 184         |
| 6EL4M          | 6609121-8          | 176         | 6VM2           | 3-6609128-0        | 184         |
| 6EMC1          | 1-6609037-2        | 24          | 6VM2S          | 3-6609128-1        | 184         |
| 6EMC3          | 1-6609037-9        | 24          | 6VM4           | 3-6609128-3        | 184         |
| 6EOP           | 6609064-3          | 21          | 6VM4C          | 3-6609128-4        | 184         |
| 6EP1           | 6609037-5          | 27          | 6VM4S          | 3-6609128-5        | 184         |
| 6EP3           | 6609037-6          | 27          | 6VM4SC         | 3-6609128-7        | 184         |
| 6EQ1           | 6609048-5          | 58          | 6VN1           | 6609052-1          | 56          |
| 6EQ3           | 6609048-6          | 58          | 6VS1           | 6609042-2          | 68          |
| 6EQ8           | 6609048-7          | 58          | 6VSB1          | 1-1609034-2        | 71          |
| 6EQ8M          | 6609048-8          | 58          | 6VSK1          | 6609036-5          | 75          |
| 6ERK1          | 1-1609036-8        | 65          | 6VSK3          | 6609036-6          | 75          |
| 6ESB1          | 1-1609034-1        | 71          | 6VSK7          | 6609036-7          | 75          |
| 6ESK1          | 6609035-5          | 75          | 6VSK7M         | 6609036-8          | 75          |
| 6ESK3          | 6609035-6          | 75          | 6VV1           | 6609043-2          | 86          |
| 6ESK7          | 6609035-7          | 75          | 7BCF10         | 1609989-1          | 113         |
| 6ESK7M         | 6609035-8          | 75          | 7EP1           | 2-6609037-4        | 27          |
| 6ESRF-3        | 1609133-1          | 201         | 7EP3           | 2-6609037-5        | 27          |
| 6ESRFC3        | 1609133-2          | 201         | 10AFC6-A       | 1609990-1          | 236         |
| 6ESRM-3        | 1609133-3          | 201         | 10AFC6-B       | 1609990-2          | 236         |
| 6ESRMC2        | 1609133-4          | 201         | 10AYO1         | 6609066-3          | 111         |

**Part Number Index and Cross Reference**

| Catalog Number | TE Ordering Number | Page Number | Catalog Number | TE Ordering Number | Page Number |
|----------------|--------------------|-------------|----------------|--------------------|-------------|
| 10CBE1         | 1609112-1          | 130         | 10EH1          | 6609012-5          | 169         |
| 10CBS1         | 1609112-2          | 130         | 10EH3          | 6609012-6          | 169         |
| 10CE1          | 1609112-3          | 130         | 10EH4          | 6609013-5          | 169         |
| 10CFE1         | 1-6609113-3        | 130         | 10EH4C         | 6609013-6          | 169         |
| 10CFS1         | 1-6609113-4        | 130         | 10EHG1-2       | 6609116-4          | 166         |
| 10CHE1         | 1-6609114-3        | 130         | 10EHG8-2       | 6609116-5          | 166         |
| 10CHS1         | 1-6609114-4        | 130         | 10EHGS1-2      | 1609116-6          | 166         |
| 10CS1          | 1609112-8          | 130         | 10EHT1         | 6609053-9          | 40          |
| 10CUFE1        | 2-1609113-5        | 134         | 10EHT3         | 1-6609053-0        | 40          |
| 10CUFF1        | 2-1609114-5        | 134         | 10EJH1         | 6609008-4          | 154         |
| 10CUFS1        | 2-1609114-0        | 134         | 10EJH2         | 1-6609008-2        | 154         |
| 10DAF1         | 6609075-8          | 212         | 10EJH8         | 3-6609008-1        | 154         |
| 10DAFP         | 6609075-7          | 212         | 10EJHP         | 1-6609008-3        | 154         |
| 10DAS1         | 2-6609075-5        | 212         | 10EJHS1        | 1-6609008-9        | 154         |
| 10DFC6-C       | 1609992-1          | 239         | 10EJHS8        | 2-6609008-5        | 154         |
| 10EAH1         | 6609002-5          | 149         | 10EJM1         | 6609985-4          | 154         |
| 10EAS1         | 6609005-9          | 149         | 10EJM8         | 1-6609985-6        | 154         |
| 10EB1          | 6609020-9          | 15          | 10EJMS1        | 1-6609985-0        | 154         |
| 10EB3          | 1-6609020-0        | 15          | 10EJMS8        | 2-6609985-1        | 154         |
| 10EBF1         | 6609018-7          | 138         | 10EJS1         | 1-6609006-6        | 154         |
| 10EBF4         | 6609018-8          | 138         | 10EJS8         | 4-6609006-0        | 154         |
| 10EBH1         | 6609003-4          | 149         | 10EJT1         | 2-6609006-4        | 163         |
| 10EBS1         | 1-6609005-4        | 149         | 10EJT8         | 2-6609006-9        | 163         |
| 10EC1          | 1-1609017-3        | 141         | 10EK1          | 1-6609027-3        | 49          |
| 10ED1          | 1-6609016-6        | 144         | 10EK3          | 1-6609027-4        | 49          |
| 10ED1C         | 1-6609016-7        | 144         | 10EK7          | 1-6609027-5        | 49          |
| 10EDK1         | 6609033-7          | 18          | 10EK7M         | 1-6609027-6        | 49          |
| 10EDK3         | 6609033-8          | 18          | 10EMC1         | 1-6609037-3        | 24          |
| 10EDP          | 6609065-4          | 21          | 10EMC3         | 2-6609037-0        | 24          |
| 10EEA1         | 1-6609000-0        | 149         | 10EMC6         | 2-6609037-1        | 24          |
| 10EEA2         | 1-6609000-1        | 149         | 10EOP          | 6609064-4          | 21          |
| 10EEAP         | 1-6609000-2        | 149         | 10EP1          | 6609037-7          | 27          |
| 10EEB1         | 1-6609001-0        | 149         | 10EP3          | 6609037-8          | 27          |
| 10EEB2         | 1-6609001-1        | 149         | 10ER1          | 1-6609031-3        | 61          |
| 10EEBP         | 1-6609001-2        | 149         | 10ER3          | 1-6609031-4        | 61          |
| 10EEJ1         | 1-6609006-3        | 154         | 10ER7          | 1-6609031-5        | 61          |
| 10EEJ2         | 1-6609006-4        | 154         | 10ER7M         | 1-6609031-6        | 61          |
| 10EEJ8         | 3-6609006-5        | 154         | 10ERK1         | 2-1609089-5        | 65          |
| 10EEJP         | 1-6609006-5        | 154         | 10ESB1         | 1-1609034-3        | 71          |
| 10EFIF         | 6609015-7          | 160         | 10ESB6         | 1-1609034-4        | 71          |
| 10EFIFC        | 6609015-8          | 160         | 10ESK1         | 6609035-9          | 75          |
| 10EG1          | 6609050-2          | 35          | 10ESK3         | 1-6609035-0        | 75          |
| 10EGG1-1       | 3-1609115-4        | 166         | 10ESK7         | 1-6609035-1        | 75          |
| 10EGG1-2       | 3-1609115-3        | 166         | 10ESK7M        | 1-6609035-2        | 75          |
| 10EGG8-1       | 3-1609115-5        | 166         | 10ET1          | 6609046-7          | 80          |
| 10EGG8-2       | 3-1609115-6        | 166         | 10ET3          | 6609046-8          | 80          |
| 10EGS1-1       | 1609117-7          | 166         | 10FFA6-BA      | 1609991-1          | 230         |
| 10EGS1-2       | 1609117-8          | 166         | 10FFA6-CE      | 1609991-9          | 230         |



**Part Number Index and Cross Reference**

| Catalog Number | TE Ordering Number | Page Number | Catalog Number | TE Ordering Number | Page Number |
|----------------|--------------------|-------------|----------------|--------------------|-------------|
| 10FFA6-GJ      | 1-1609991-8        | 230         | 15CUE1         | 2-1609114-7        | 134         |
| 10FFD6-CA      | 1609993-1          | 233         | 15CUFE1        | 2-1609113-6        | 134         |
| 10FFD6-HE      | 1609993-7          | 233         | 15CUFF1        | 2-1609114-6        | 134         |
| 10MV1          | 6609056-3          | 54          | 15CUFS1        | 2-1609114-1        | 134         |
| 10VB1          | 6609021-9          | 15          | 15CUS1         | 2-1609114-9        | 134         |
| 10VB3          | 1-6609021-0        | 15          | 15DAF1         | 1-6609075-0        | 212         |
| 10VB6          | 1-6609021-2        | 15          | 15DAFP         | 6609075-9          | 212         |
| 10VDK1         | 6609034-7          | 18          | 15DAS1         | 2-6609075-9        | 212         |
| 10VDK3         | 6609034-8          | 18          | 15DCB10        | 4-6609074-1        | 218         |
| 10VG1          | 6609051-2          | 35          | 15DCB10B       | 4-6609074-3        | 218         |
| 10VK1          | 1-6609028-3        | 49          | 15DCB10BF      | 4-6609074-4        | 218         |
| 10VK3          | 1-6609028-4        | 49          | 15DCB10F       | 4-6609074-2        | 218         |
| 10VK6          | 1-6609028-8        | 49          | 15DCB6         | 2-6609074-1        | 218         |
| 10VK7          | 1-6609028-5        | 49          | 15DCB6B        | 2-6609074-3        | 218         |
| 10VK7M         | 1-6609028-6        | 49          | 15DCB6BF       | 2-6609074-4        | 218         |
| 10VNI          | 6609052-2          | 56          | 15DCB6F        | 2-6609074-2        | 218         |
| 10VR1          | 1-6609032-3        | 61          | 15DCF10        | 1-6609074-1        | 218         |
| 10VR3          | 1-6609032-4        | 61          | 15DCF10B       | 1-6609074-2        | 218         |
| 10VR6          | 1-6609032-5        | 61          | 15DCF6         | 6609074-1          | 218         |
| 10VR7          | 1-6609032-6        | 61          | 15DCF6B        | 6609074-2          | 218         |
| 10VR7M         | 1-6609032-7        | 61          | 15ED1          | 1-6609016-8        | 144         |
| 10VS1          | 6609042-3          | 68          | 15ED8          | 1-6609016-9        | 144         |
| 10VSB1         | 1-1609034-5        | 71          | 15EEJ1         | 1-6609006-7        | 154         |
| 10VSB6         | 1-1609034-6        | 71          | 15EEJ2         | 1-6609006-9        | 154         |
| 10VSK1         | 6609036-9          | 75          | 15EEJ8         | 3-6609006-6        | 154         |
| 10VSK3         | 1-6609036-0        | 75          | 15EEJP         | 2-6609006-0        | 154         |
| 10VSK7         | 1-6609036-1        | 75          | 15EF1F         | 6609015-9          | 160         |
| 10VSK7M        | 1-6609036-2        | 75          | 15EH4          | 6609013-7          | 169         |
| 10VT1          | 6609047-1          | 80          | 15EHT1         | 1-6609053-1        | 40          |
| 10VT3          | 6609047-2          | 80          | 15EHT6         | 1-6609053-2        | 40          |
| 10VV1          | 6609043-3          | 86          | 15EJH1         | 6609008-5          | 154         |
| 10VW1          | 6609044-3          | 86          | 15EJH2         | 1-6609008-4        | 154         |
| 12EP1          | 2-6609037-6        | 27          | 15EJH8         | 3-6609008-2        | 154         |
| 12EP3          | 2-6609037-7        | 27          | 15EJHP         | 1-6609008-5        | 154         |
| 12FC10         | 6609069-2          | 30          | 15EJHS1        | 2-6609008-0        | 154         |
| 12FC10B        | 1609976-3          | 30          | 15EJHS8        | 2-6609008-6        | 154         |
| 12FCD10        | 6609070-2          | 119         | 15EJM1         | 6609985-5          | 154         |
| 12FCD10B       | 6609974-4          | 119         | 15EJM8         | 1-6609985-7        | 154         |
| 15CBE1         | 1-1609112-4        | 130         | 15EJMS1        | 1-6609985-1        | 154         |
| 15CBS1         | 1-1609112-3        | 130         | 15EJMS8        | 2-6609985-2        | 154         |
| 15CE1          | 1-1609112-2        | 130         | 15EJS1         | 1-6609006-8        | 154         |
| 15CS1          | 1-1609112-1        | 130         | 15EJS8         | 4-6609006-1        | 154         |
| 15CU10BS1      | 1-1609112-7        | 134         | 15EJT1         | 2-6609006-5        | 163         |
| 15CU10S1       | 1-1609112-6        | 134         | 15EJT8         | 3-6609006-0        | 163         |
| 15CU15BS1      | 1-1609112-9        | 134         | 15EMC1         | 1-6609037-4        | 24          |
| 15CU15S1       | 1-1609112-8        | 134         | 15EMC3         | 2-6609037-2        | 24          |
| 15CUBE1        | 2-1609114-8        | 134         | 15EMC6         | 2-6609037-3        | 24          |
| 15CUBS1        | 1-1609112-5        | 134         | 15ERK1         | 2-1609089-6        | 65          |

**Part Number Index and Cross Reference**

| Catalog Number | TE Ordering Number | Page Number | Catalog Number | TE Ordering Number | Page Number |
|----------------|--------------------|-------------|----------------|--------------------|-------------|
| 15ET1          | 6609046-9          | 80          | 15SRBS8-S      | 3-6609987-0        | 204         |
| 15ET6          | 1-6609046-0        | 80          | 15SRBS8-T      | 3-6609987-1        | 204         |
| 15SRB1         | 6609987-9          | 204         | 15SRBS8-W      | 3-6609987-2        | 204         |
| 15SRB1-Q       | 6609987-1          | 204         | 15SRBS8-X      | 3-6609987-3        | 204         |
| 15SRB1-R       | 6609987-2          | 204         | 15SRBX8        | 5-1609987-6        | 204         |
| 15SRB1-S       | 6609987-3          | 204         | 15SRBX8-Q      | 5-1609987-7        | 204         |
| 15SRB1-T       | 6609987-4          | 204         | 15SRBX8-R      | 5-1609987-8        | 204         |
| 15SRB1-W       | 6609987-5          | 204         | 15SRBX8-S      | 5-1609987-9        | 204         |
| 15SRB1-X       | 6609987-6          | 204         | 15SRBX8-T      | 6-1609987-0        | 204         |
| 15SRB1-Y       | 6609987-7          | 204         | 15SRBX8-W      | 6-1609987-1        | 204         |
| 15SRB1-Z       | 6609987-8          | 204         | 15SRBX8-X      | 6-1609987-2        | 204         |
| 15SRB2         | 5-6609987-4        | 204         | 15SRBY8        | 6-1609987-5        | 204         |
| 15SRB2-Q       | 4-6609987-6        | 204         | 15SRBY8-Q      | 6-1609987-6        | 204         |
| 15SRB2-R       | 4-6609987-7        | 204         | 15SRBY8-R      | 6-1609987-7        | 204         |
| 15SRB2-S       | 4-6609987-8        | 204         | 15SRBY8-S      | 6-1609987-8        | 204         |
| 15SRB2-T       | 4-6609987-9        | 204         | 15SRBY8-T      | 6-1609987-9        | 204         |
| 15SRB2-W       | 5-6609987-0        | 204         | 15SRBY8-W      | 7-1609987-0        | 204         |
| 15SRB2-X       | 5-6609987-1        | 204         | 15SRBY8-X      | 7-1609987-1        | 204         |
| 15SRB2-Y       | 5-6609987-2        | 204         | 15VT1          | 6609047-3          | 80          |
| 15SRB2-Z       | 5-6609987-3        | 204         | 15VT6          | 6609047-4          | 80          |
| 15SRB8         | 1-6609987-8        | 204         | 16AFC6-B       | 1609990-3          | 236         |
| 15SRB8-Q       | 1-6609987-0        | 204         | 16AFC6-C       | 1609990-4          | 236         |
| 15SRB8-R       | 1-6609987-1        | 204         | 16AFC6-G       | 1609990-5          | 236         |
| 15SRB8-S       | 1-6609987-2        | 204         | 16AFC6-H       | 1609990-6          | 236         |
| 15SRB8-T       | 1-6609987-3        | 204         | 16AYA10        | 6609977-1          | 104         |
| 15SRB8-W       | 1-6609987-4        | 204         | 16AYA6         | 6609068-1          | 104         |
| 15SRB8-X       | 1-6609987-5        | 204         | 16AYA6A        | 6609068-2          | 104         |
| 15SRBP         | 4-6609987-5        | 204         | 16AYC10B       | 6609067-1          | 108         |
| 15SRBP-Q       | 3-6609987-7        | 204         | 16BCF10        | 1609989-2          | 113         |
| 15SRBP-R       | 3-6609987-8        | 204         | 16DFC6-C       | 1609992-2          | 239         |
| 15SRBP-S       | 3-6609987-9        | 204         | 16DFC6-G       | 1609992-3          | 239         |
| 15SRBP-T       | 4-6609987-0        | 204         | 16DFC6-H       | 1609992-4          | 239         |
| 15SRBP-W       | 4-6609987-1        | 204         | 16DFC6-N       | 1609992-5          | 239         |
| 15SRBP-X       | 4-6609987-2        | 204         | 16FC10         | 6609069-3          | 30          |
| 15SRBP-Y       | 4-6609987-3        | 204         | 16FC10B        | 1609976-1          | 30          |
| 15SRBP-Z       | 4-6609987-4        | 204         | 16FCD10        | 6609070-3          | 119         |
| 15SRBS1        | 2-6609987-7        | 204         | 16FCD10B       | 6609974-5          | 119         |
| 15SRBS1-Q      | 1-6609987-9        | 204         | 16FFA6-CA      | 1609991-2          | 230         |
| 15SRBS1-R      | 2-6609987-0        | 204         | 16FFA6-DG      | 1-1609991-1        | 230         |
| 15SRBS1-S      | 2-6609987-1        | 204         | 16FFA6-HN      | 1-1609991-9        | 230         |
| 15SRBS1-T      | 2-6609987-2        | 204         | 16FFD6-CA      | 1609993-2          | 233         |
| 15SRBS1-W      | 2-6609987-3        | 204         | 16FFD6-HE      | 1609993-8          | 233         |
| 15SRBS1-X      | 2-6609987-4        | 204         | 16IK10         | 6609973-1          | 46          |
| 15SRBS1-Y      | 2-6609987-5        | 204         | 16WGA1         | 2-6609089-4        | 89          |
| 15SRBS1-Z      | 2-6609987-6        | 204         | 16WGA3         | 7-6609089-6        | 89          |
| 15SRBS8        | 3-6609987-6        | 204         | 16WGA7         | 3-1609090-8        | 89          |
| 15SRBS8-Q      | 2-6609987-8        | 204         | 16WGB1         | 4-6609089-0        | 89          |
| 15SRBS8-R      | 2-6609987-9        | 204         | 16WGB3         | 7-6609089-7        | 89          |

**Part Number Index and Cross Reference**

| Catalog Number | TE Ordering Number | Page Number | Catalog Number | TE Ordering Number | Page Number |
|----------------|--------------------|-------------|----------------|--------------------|-------------|
| 16WGB7         | 3-1609090-9        | 89          | 20VK6          | 1-6609028-9        | 49          |
| 16WGC1         | 4-6609089-1        | 89          | 20VP1          | 6609038-1          | 27          |
| 16WGC3         | 7-6609089-8        | 89          | 20VP6          | 6609038-2          | 27          |
| 16WGC7         | 4-1609090-0        | 89          | 20VQ1          | 6609049-5          | 58          |
| 16WGD1         | 4-6609089-6        | 89          | 20VR1          | 1-6609032-8        | 61          |
| 16WGD3         | 7-6609089-9        | 89          | 20VR6          | 1-6609032-9        | 61          |
| 16WGD7         | 4-1609090-1        | 89          | 20VS1          | 6609042-4          | 68          |
| 16WGE1         | 4-6609089-7        | 89          | 20VS6          | 6609042-5          | 68          |
| 16WGE3         | 8-6609089-0        | 89          | 20VSB1         | 1-1609034-9        | 71          |
| 16WGE7         | 4-1609090-2        | 89          | 20VSB6         | 2-1609034-0        | 71          |
| 16WGF1         | 4-6609089-8        | 89          | 20VSK6         | 1-6609036-3        | 75          |
| 16WGF3         | 8-6609089-1        | 89          | 20VT1          | 6609047-5          | 80          |
| 16WGF7         | 4-1609090-3        | 89          | 20VT6          | 6609047-6          | 80          |
| 20AFC6-B       | 1609990-7          | 236         | 20VV1          | 6609043-4          | 86          |
| 20AYO1         | 6609066-4          | 111         | 20VV6          | 6609043-5          | 86          |
| 20AYP6C        | 6609072-1          | 99          | 20VW1          | 6609044-4          | 86          |
| 20AYT6C        | 6609073-1          | 99          | 20VW6          | 6609044-5          | 86          |
| 20EB1          | 1-6609020-1        | 15          | 25AYA6         | 6609068-3          | 104         |
| 20EDK1         | 6609033-9          | 18          | 25AYA6A        | 6609977-2          | 104         |
| 20EEJ1         | 6609007-3          | 154         | 25AYC10B       | 6609068-4          | 108         |
| 20EEJ8         | 6609007-6          | 154         | 25FC10         | 6609069-4          | 30          |
| 20EJH1         | 6609009-4          | 154         | 25FC10B        | 6609976-2          | 30          |
| 20EJH8         | 6609009-5          | 154         | 25FCD10        | 6609070-4          | 119         |
| 20EJS1         | 6609007-5          | 154         | 25FCD10B       | 6609974-9          | 119         |
| 20EJS8         | 6609007-7          | 154         | 30AYP6C        | 6609072-2          | 99          |
| 20EJT1         | 6609007-8          | 163         | 30AYT6C        | 6609073-2          | 99          |
| 20EJT8         | 3-6609006-1        | 163         | 30BCF10        | 1609989-3          | 113         |
| 20EK1          | 1-6609027-7        | 49          | 30DCB10        | 4-6609074-5        | 218         |
| 20EMC1         | 1-6609037-5        | 24          | 30DCB10B       | 4-6609074-7        | 218         |
| 20EMC6         | 1-6609037-7        | 24          | 30DCB10BF      | 4-6609074-8        | 218         |
| 20EP1          | 6609037-9          | 27          | 30DCB10F       | 4-6609074-6        | 218         |
| 20EP6          | 1-6609037-0        | 27          | 30DCB6         | 2-6609074-5        | 218         |
| 20EQ1          | 6609048-9          | 58          | 30DCB6B        | 2-6609074-7        | 218         |
| 20ER1          | 1-6609031-7        | 61          | 30DCB6BF       | 2-6609074-8        | 218         |
| 20ERK1         | 2-1609089-7        | 65          | 30DCB6F        | 2-6609074-6        | 218         |
| 20ESB1         | 1-1609034-7        | 71          | 30DCF10        | 1-6609074-3        | 218         |
| 20ESB6         | 1-1609034-8        | 71          | 30DCF10B       | 1-6609074-4        | 218         |
| 20ESK6         | 1-6609035-3        | 75          | 30DCF6         | 6609074-3          | 218         |
| 20ESRM-3       | 4-1609134-7        | 201         | 30DCF6B        | 6609074-4          | 218         |
| 20ESRMC2       | 4-1609134-8        | 201         | 30EMC6         | 1-6609037-6        | 24          |
| 20ET1          | 1-6609046-1        | 80          | 30ESB6         | 2-1609034-1        | 71          |
| 20ET6          | 1-6609046-2        | 80          | 30ESK6         | 1-6609035-4        | 75          |
| 20MV1          | 6609056-4          | 54          | 30ESK6C        | 1-6609035-5        | 75          |
| 20VB1          | 1-6609021-1        | 15          | 30VB6          | 1-6609021-4        | 15          |
| 20VB6          | 1-6609021-3        | 15          | 30VK6          | 2-6609028-0        | 49          |
| 20VDK1         | 6609034-9          | 18          | 30VK6C         | 2-6609028-1        | 49          |
| 20VDK6         | 1-6609034-0        | 18          | 30VSB6         | 2-1609034-2        | 71          |
| 20VK1          | 1-6609028-7        | 49          | 30VSK6         | 1-6609036-4        | 75          |

**Part Number Index and Cross Reference**

| Catalog Number | TE Ordering Number | Page Number | Catalog Number | TE Ordering Number | Page Number |
|----------------|--------------------|-------------|----------------|--------------------|-------------|
| 30VSK6C        | 1-6609036-5        | 75          | 60DBPL9        | 5-1609075-1        | 214         |
| 32AFC6-B       | 1609990-8          | 236         | 60DBR          | 5-1609075-6        | 214         |
| 32AFC6-C       | 1609990-9          | 236         | 60DBRL1        | 6-1609075-4        | 214         |
| 32AFC6-F       | 1-1609990-1        | 236         | 60DBRL3        | 6-1609075-5        | 214         |
| 32AFC6-G       | 1-1609990-2        | 236         | 60DBX8         | 4-1609075-7        | 214         |
| 32AFC6-H       | 1-1609990-3        | 236         | 60DCB10        | 4-6609074-9        | 218         |
| 32DFC6-C       | 1609992-6          | 239         | 60DCB10B       | 5-6609074-1        | 218         |
| 32DFC6-G       | 1609992-7          | 239         | 60DCB10BF      | 5-6609074-2        | 218         |
| 32DFC6-H       | 1609992-8          | 239         | 60DCB10F       | 5-6609074-0        | 218         |
| 32DFC6-N       | 1609992-9          | 239         | 60DCB6         | 2-6609074-9        | 218         |
| 32FFA6-CA      | 1609991-3          | 230         | 60DCB6B        | 3-6609074-1        | 218         |
| 32FFA6-DH      | 1-1609991-2        | 230         | 60DCB6BF       | 3-6609074-2        | 218         |
| 32FFA6-HN      | 2-1609991-1        | 230         | 60DCB6F        | 3-6609074-0        | 218         |
| 32FFD6-CA      | 1609993-3          | 233         | 60DCF10        | 1-6609074-5        | 218         |
| 32FFD6-HE      | 1609993-9          | 233         | 60DCF10B       | 1-6609074-6        | 218         |
| 35IK10         | 6609973-2          | 46          | 60DCF6         | 6609074-5          | 218         |
| 36AYA10        | 6609068-6          | 104         | 60DCF6B        | 6609074-6          | 218         |
| 36AYA6         | 6609068-5          | 104         | 60VK6          | 2-6609028-5        | 49          |
| 36AYA6A        | 6609977-3          | 104         | 60VS6          | 1609042-6          | 68          |
| 36AYC10B       | 6609067-2          | 108         | 63ADT6         | 1609071-2          | 101         |
| 36FC10         | 6609069-5          | 30          | 63ADT6S        | 1609071-1          | 101         |
| 36FC10B        | 1609976-4          | 30          | 63AFC6-C       | 1-1609990-4        | 236         |
| 36FCD10        | 6609070-5          | 119         | 63AFC6-G       | 1-1609990-5        | 236         |
| 36FCD10B       | 1-6609974-1        | 119         | 63AFC6-H       | 1-1609990-6        | 236         |
| 40VK6          | 2-6609028-3        | 49          | 63AYA10        | 1609977-5          | 104         |
| 40VK6C         | 2-6609028-4        | 49          | 63AYA6A        | 6609977-8          | 104         |
| 40VSK6         | 1-6609036-6        | 75          | 63AYC10B       | 6609067-3          | 108         |
| 42BCF10        | 1609989-4          | 113         | 63DFC6-C       | 1-1609992-1        | 239         |
| 45AYP6C        | 6609072-3          | 99          | 63DFC6-G       | 1-1609992-2        | 239         |
| 45AYT6C        | 6609073-3          | 99          | 63DFC6-H       | 1-1609992-3        | 239         |
| 50AYA6         | 6609068-7          | 104         | 63DFC6-N       | 1-1609992-4        | 239         |
| 50AYA6A        | 6609068-8          | 104         | 63FFA6-GB      | 1609991-4          | 230         |
| 50FC10         | 6609069-6          | 30          | 63FFA6-JK      | 1-1609991-3        | 230         |
| 50FC10B        | 6609069-7          | 30          | 63FFA6-NP      | 2-1609991-2        | 230         |
| 50FCD10        | 6609070-6          | 119         | 63FFD6-HB      | 1609993-4          | 233         |
| 50FCD10B       | 1-6609974-3        | 119         | 63FFD6-NH      | 1-1609993-1        | 233         |
| 50FCD10BS      | 1-6609974-6        | 119         | 75BCF10        | 1609989-6          | 113         |
| 50FCD10BS      | 1-6609974-6        | 119         | 80AYC10B       | 6609067-4          | 108         |
| 50IK10         | 1609973-5          | 46          | 80FCD10B       | 6609070-7          | 119         |
| 55BCF10        | 1609989-5          | 113         | 80FCD10BS      | 1-6609974-7        | 119         |
| 60AYP6C        | 6609072-4          | 99          | 80IK10         | 6609973-3          | 46          |
| 60AYT6C        | 6609073-4          | 99          | 100ADT6        | 1609071-4          | 101         |
| 60DB8          | 4-1609075-4        | 214         | 100ADT6S       | 1609071-3          | 101         |
| 60DBF8         | 4-1609075-5        | 214         | 100AFC6-H      | 1-1609990-8        | 236         |
| 60DBJ8         | 4-1609075-6        | 214         | 100AFC6-H      | 1-1609990-8        | 236         |
| 60DBP          | 5-1609075-7        | 214         | 100AFC6-K      | 1-1609990-9        | 236         |
| 60DBPL1        | 4-1609075-9        | 214         | 100AFC6-N      | 2-1609990-1        | 236         |
| 60DBPL3        | 5-1609075-0        | 214         | 100AYA6A       | 6609977-7          | 104         |

**Part Number Index and Cross Reference**

| Catalog Number | TE Ordering Number | Page Number | Catalog Number | TE Ordering Number | Page Number |
|----------------|--------------------|-------------|----------------|--------------------|-------------|
| 100BCF10       | 1609989-7          | 113         | 180FCD10B      | 1-6609070-0        | 119         |
| 100DCB10       | 5-6609074-3        | 218         | 180FCD10BS     | 2-6609974-1        | 119         |
| 100DCB10B      | 5-6609074-5        | 218         | 200ADT6        | 1609071-8          | 101         |
| 100DCB10BF     | 5-6609074-6        | 218         | 200ADT6S       | 1609071-7          | 101         |
| 100DCB10F      | 5-6609074-4        | 218         | 200AFC6-H      | 2-1609990-2        | 236         |
| 100DCB6        | 3-6609074-3        | 218         | 200AFC6-K      | 2-1609990-3        | 236         |
| 100DCB6B       | 3-6609074-5        | 218         | 200AFC6-N      | 2-1609990-4        | 236         |
| 100DCB6BF      | 3-6609074-6        | 218         | 200AFC6-P      | 2-1609990-5        | 236         |
| 100DCB6F       | 3-6609074-4        | 218         | 200AYC10B      | 1609067-8          | 108         |
| 100DCF10       | 1-6609074-7        | 218         | 200DFC6-H      | 1-1609992-9        | 239         |
| 100DCF10B      | 1-6609074-8        | 218         | 200DFC6-N      | 2-1609992-1        | 239         |
| 100DCF6        | 6609074-7          | 218         | 200DFC6-P      | 2-1609992-2        | 239         |
| 100DCF6B       | 6609074-8          | 218         | 200DFC6-R      | 2-1609992-3        | 239         |
| 100DFC6-G      | 1-1609992-5        | 239         | 200FFA6-HD     | 1609991-6          | 230         |
| 100DFC6-H      | 1-1609992-6        | 239         | 200FFA6-NP     | 1-1609991-5        | 230         |
| 100DFC6-N      | 1-1609992-7        | 239         | 200FFA6-PP     | 2-1609991-4        | 230         |
| 100DFC6-P      | 1-1609992-8        | 239         | 200FFD6-ND     | 1609993-6          | 233         |
| 100FFA6-HC     | 1609991-5          | 230         | 200FFD6-RP     | 1-1609993-3        | 233         |
| 100FFA6-NP     | 1-1609991-4        | 230         | 230FCD10B      | 1-6609070-2        | 119         |
| 100FFA6-PP     | 2-1609991-3        | 230         | 230FCD10BS     | 3-6609974-6        | 119         |
| 100FFD6-NC     | 1609993-5          | 233         | 250AFC6-H      | 2-1609990-6        | 236         |
| 100FFD6-PK     | 1-1609993-2        | 233         | 250AFC6-K      | 2-1609990-7        | 236         |
| 110AYC10B      | 6609067-5          | 108         | 250AFC6-N      | 2-1609990-8        | 236         |
| 110FCD10B      | 6609070-8          | 119         | 250AFC6-P      | 2-1609990-9        | 236         |
| 110FCD10BS     | 1-6609974-8        | 119         | 250DFC6-P      | 2-1609992-4        | 239         |
| 125DCB10       | 5-6609074-7        | 218         | 250DFC6-Q      | 2-1609992-5        | 239         |
| 125DCB10B      | 5-6609074-9        | 218         | 250DFC6-T      | 2-1609992-6        | 239         |
| 125DCB10BF     | 6-6609074-0        | 218         | 250FFA6-HF     | 1609991-7          | 230         |
| 125DCB10F      | 5-6609074-8        | 218         | 250FFA6-NP     | 1-1609991-6        | 230         |
| 125DCB6        | 3-6609074-7        | 218         | 250FFA6-PP     | 2-1609991-5        | 230         |
| 125DCB6B       | 3-6609074-9        | 218         | 300AFC6-H      | 3-1609990-1        | 236         |
| 125DCB6BF      | 4-1609074-0        | 218         | 300AFC6-K      | 3-1609990-2        | 236         |
| 125DCB6F       | 3-6609074-8        | 218         | 300AFC6-N      | 3-1609990-3        | 236         |
| 125DCF10       | 1-6609074-9        | 218         | 300AFC6-P      | 3-1609990-4        | 236         |
| 125DCF10B      | 2-6609074-0        | 218         | 300CFN12       | 1609978-1          | 116         |
| 125DCF6        | 6609074-9          | 218         | 300DFC6-P      | 2-1609992-7        | 239         |
| 125DCF6B       | 1-6609074-0        | 218         | 300DFC6-Q      | 2-1609992-8        | 239         |
| 130BCF10       | 1609989-8          | 113         | 300DFC6-T      | 2-1609992-9        | 239         |
| 150AYC10B      | 6609067-6          | 108         | 300FFA6-HF     | 1609991-8          | 230         |
| 150AYC10B-95   | 1609067-7          | 108         | 300FFA6-NP     | 1-1609991-7        | 230         |
| 150FCD10B      | 6609070-9          | 119         | 300FFA6-PP     | 2-1609991-6        | 230         |
| 150FCD10B-95   | 3-6609974-3        | 119         | 400CFN12       | 1-1609979-7        | 116         |
| 150FCD10BS     | 2-6609974-0        | 119         | 500CFN12       | 6609978-3          | 116         |
| 150FCD10BS-95  | 1-6609974-9        | 119         | 600CFN12       | 6609978-4          | 116         |
| 160ADT6        | 1609071-6          | 101         | PE000DD3D      | 6609110-1          | 223         |
| 160ADT6S       | 1609071-5          | 101         | PE000DD6D      | 6609110-3          | 223         |
| 180AYC10B      | 6609977-6          | 108         | PE000DDXD      | 6609110-5          | 223         |
| 180BCF10       | 1609989-9          | 113         | PE000SD3D      | 6609110-2          | 223         |

**Part Number Index and Cross Reference**

| Catalog Number | TE Ordering Number | Page Number | Catalog Number | TE Ordering Number | Page Number |
|----------------|--------------------|-------------|----------------|--------------------|-------------|
| PE000SD6D      | 6609110-4          | 223         | RJ45-6L1-B     | 5-6609208-0        | 247         |
| PE000SDXD      | 6609110-6          | 223         | RJ45-6L1-S     | 4-6609208-9        | 247         |
| PS000DD3D      | 6609111-3          | 223         | RJ45-6L2-B     | 5-6609208-2        | 247         |
| PS000DD6D      | 6609111-5          | 223         | RJ45-6L2-S     | 5-6609208-1        | 247         |
| PS000DDXD      | 6609111-7          | 223         | RJ45-6L-B      | 4-6609208-8        | 247         |
| PS000SD3D      | 6609111-4          | 223         | RJ45-6LC1-B    | 2-6609209-7        | 249         |
| PS000SD6D      | 6609111-6          | 223         | RJ45-6LC1-S    | 2-6609209-6        | 249         |
| PS000SDXD      | 6609111-8          | 223         | RJ45-6LC2-B    | 2-6609209-9        | 249         |
| RJ11-2L2-B     | 1-1609208-2        | 247         | RJ45-6LC2-S    | 2-6609209-8        | 249         |
| RJ11-2L-B      | 6609208-4          | 247         | RJ45-6L-S      | 4-6609208-7        | 247         |
| RJ11-2LC1-B    | 6609209-2          | 249         | RJ45-6X        | 1-6609214-0        | 252         |
| RJ11-2LC1-S    | 6609209-1          | 249         | RJ45-8L1-B     | 5-6609208-7        | 247         |
| RJ11-2LC2-B    | 6609209-4          | 249         | RJ45-8L1-S     | 5-6609208-5        | 247         |
| RJ11-2LC2-S    | 6609209-3          | 249         | RJ45-8L2-B     | 6-6609208-0        | 247         |
| RJ11-2L-S      | 6609208-1          | 247         | RJ45-8L2-S     | 5-6609208-9        | 247         |
| RJ11-2X        | 6609214-1          | 252         | RJ45-8L-B      | 5-6609208-4        | 247         |
| RJ11-4L1-B     | 2-1609208-2        | 247         | RJ45-8LC1-B    | 3-6609209-3        | 249         |
| RJ11-4L1-S     | 2-6609208-1        | 247         | RJ45-8LC1-S    | 3-6609209-0        | 249         |
| RJ11-4L2-B     | 2-6609208-7        | 247         | RJ45-8LC2-B    | 4-6609209-1        | 249         |
| RJ11-4L2-S     | 2-6609208-5        | 247         | RJ45-8LC2-S    | 3-6609209-6        | 249         |
| RJ11-4L-B      | 1-6609208-7        | 247         | RJ45-8LCT1-B   | 1-6609211-1        | 250         |
| RJ11-4LC1-B    | 6609209-8          | 249         | RJ45-8LCT1-S   | 1-6609211-0        | 250         |
| RJ11-4LC1-S    | 6609209-6          | 249         | RJ45-8LCT2-B   | 1-6609211-3        | 250         |
| RJ11-4LC2-B    | 1-6609209-3        | 249         | RJ45-8LCT2-S   | 1-6609211-2        | 250         |
| RJ11-4LC2-S    | 1-6609209-0        | 249         | RJ45-8L-S      | 5-6609208-3        | 247         |
| RJ11-4L-S      | 1-6609208-5        | 247         | RJ45-8N3-B     | 1-6609212-3        | 251         |
| RJ11-4X        | 6609214-3          | 252         | RJ45-8N3-S     | 1-6609212-4        | 251         |
| RJ11-6L1-B     | 4-6609208-0        | 247         | RJ45-8N4-B     | 1-6609212-5        | 251         |
| RJ11-6L1-S     | 3-6609208-8        | 247         | RJ45-8N4-S     | 1-6609212-6        | 251         |
| RJ11-6L2-B     | 4-6609208-5        | 247         | RJ45-8N-B      | 1-6609212-0        | 251         |
| RJ11-6L2-S     | 4-6609208-3        | 247         | RJ45-8N-S      | 1-6609212-2        | 251         |
| RJ11-6L-B      | 3-6609208-1        | 247         | RJ45-8X        | 1-6609214-1        | 252         |
| RJ11-6LC1-B    | 1-6609209-8        | 249         | RJ45-8X1       | 1-6609210-4        | 252         |
| RJ11-6LC1-S    | 1-6609209-6        | 249         | RJ45-8X2       | 1-6609214-3        | 252         |
| RJ11-6LC2-B    | 2-6609209-1        | 249         | RJ45-8Z        | 6609215-4          | 253         |
| RJ11-6LC2-S    | 2-6609209-0        | 249         | RJ45-8Z3       | 6609215-5          | 253         |
| RJ11-6LCT1-B   | 6609211-4          | 250         | RJ45-8Z4       | 6609215-6          | 253         |
| RJ11-6LCT1-S   | 6609211-1          | 250         | RJH-4L-B       | 6-6609208-1        | 247         |
| RJ11-6LCT2-B   | 6609211-8          | 250         |                |                    |             |
| RJ11-6LCT2-S   | 6609211-6          | 250         |                |                    |             |
| RJ11-6L-S      | 2-6609208-9        | 247         |                |                    |             |
| RJ11-6N3-B     | 6609212-6          | 251         |                |                    |             |
| RJ11-6N4-B     | 6609212-8          | 251         |                |                    |             |
| RJ11-6N-B      | 6609212-4          | 251         |                |                    |             |
| RJ11-6X        | 6609214-5          | 252         |                |                    |             |
| RJ11-6Z        | 6609215-1          | 253         |                |                    |             |
| RJ11-6Z3       | 6609215-2          | 253         |                |                    |             |
| RJ11-6Z4       | 6609215-3          | 253         |                |                    |             |

---

## Engineering Notes

---

A large, empty grid area for writing engineering notes, consisting of a uniform pattern of small squares.

**North American Sales Representatives**

**ALABAMA**

CARTWRIGHT & BEAN, INC.      HUNTSVILLE, AL      800-242-5876

**ALASKA**

TE CONNECTIVITY      MUNDELEIN, IL      847-573-6504

**ARIZONA**

LUSCOMBE ENGINEERING      PHOENIX, AZ      602-678-1955

**ARKANSAS**

ELECTRA REPS      PLANO, TX      972-599-2130

**CALIFORNIA**

LUSCOMBE ENGINEERING (SOUTH)      CAMARILLO, CA      805-987-4880  
 LUSCOMBE ENGINEERING (SOUTH)      COSTA MESA, CA      714-546-4880  
 LUSCOMBE ENGINEERING (SOUTH)      SAN DIEGO, CA      858-385-2655  
 STRAUBE ASSOCIATES (NORTH)      MOUNTAIN VIEW, CA      650-969-6060

**CANADA**

WEISS COMPANY      MONTREAL      514-337-6769  
 WEISS COMPANY      OTTAWA      613-599-8787  
 WEISS COMPANY      TORONTO      905-238-9548  
 WEISS COMPANY      VANCOUVER      604-276-8735

**COLORADO**

STRAUBE ASSOCIATES ROCKY MOUNTAINS, INC.      WESTMINSTER, CO      303-426-0890

**CONNECTICUT**

CONTI-YOUNGER ASSOCIATES      MARLBORO, MA      508-485-7204

**DELAWARE**

ASTROREP MID-ATLANTIC, INC.      DOYLESTOWN, PA      267-880-6321

**DISTRICT OF COLUMBIA**

ASTROREP MID-ATLANTIC, INC.      DOYLESTOWN, PA      267-880-6321

**FLORIDA**

CBX ELECTRONICS      CASSELBERRY, FL      407-774-9100

**GEORGIA**

CARTWRIGHT & BEAN, INC.      NORCROSS, GA      800-242-5876

**ILLINOIS**

RATHSBURG ASSOCIATES (NORTH)      ITASCA, IL      630-625-5100  
 RATHSBURG ASSOCIATES (SOUTH)      ST. LOUIS, MO      636-946-1001

**IDAHO**

HALBAR-RTS, INC.      KIRKLAND, WA      425-893-8400

**INDIANA**

RATHSBURG ASSOCIATES      CARMEL, IN      317-818-7055

**IOWA**

RATHSBURG ASSOCIATES      BLOOMINGTON, MN      952-893-1400

**KANSAS**

RATHSBURG ASSOCIATES      OLATHE, KS      913-829-2800

**KENTUCKY**

RATHSBURG ASSOCIATES      EASTERN      248-615-4000  
 RATHSBURG ASSOCIATES      WESTERN      317-818-7055

**LOUISIANA**

ELECTRA REPS      PLANO, TX      972-599-2130

**MAINE**

CONTI-YOUNGER ASSOCIATES      MARLBORO, MA      508-485-7204

**MARYLAND**

ASTROREP MID-ATLANTIC, INC.      DOYLESTOWN, PA      267-880-6321

**MASSACHUSETTS**

CONTI-YOUNGER ASSOCIATES      MARLBORO, MA      508-485-7204

**MEXICO**

TE CONNECTIVITY      MUNDELEIN, IL      847-573-6504

**MICHIGAN**

RATHSBURG ASSOCIATES      NOVI, MI      248-615-4000

**MINNESOTA**

RATHSBURG ASSOCIATES      BLOOMINGTON, MN      952-893-1400

**MISSISSIPPI**

CARTWRIGHT & BEAN, INC.      HUNTSVILLE, AL      800-242-5876

**MISSOURI**

RATHSBURG ASSOCIATES      ST. LOUIS, MO      636-946-1001

**MONTANA**

HALBAR-RTS, INC.      KIRKLAND, WA      425-893-8400



**North American Sales Representatives**

**NEBRASKA**

RATHSBURG ASSOCIATES      OLATHE, KS      913-829-2800

**NEVADA**

STRAUBE ASSOCIATES      MOUNTAIN VIEW, CA      650-969-6060  
LUSCOMBE ENGINEERING (LAS VEGAS)      PHOENIX, AZ      602-678-1955

**NEW HAMPSHIRE**

CONTI-YOUNGER ASSOCIATES      MARLBORO, MA      508-485-7204

**NEW JERSEY**

ASTROREP MID-ATLANTIC, INC. (SOUTH)      DOYLESTOWN, PA      267-880-6321  
ASTROREP, INC. (NORTH)      BABYLON, NY      631-422-2500

**NEW MEXICO**

LUSCOMBE ENGINEERING      PHOENIX, AZ      602-678-1955

**NEW YORK**

EMPIRE TECHNICAL ASSOCIATES (UPSTATE)      SKANEATELES, NY      315-685-5703  
ASTROREP INC.      BABYLON, NY      631-422-2500

**NORTH CAROLINA**

CARTWRIGHT & BEAN, INC. (WEST)      CHARLOTTE, NC      800-242-5876  
CARTWRIGHT & BEAN, INC. (EAST)      RALEIGH, NC      800-242-5876

**NORTH DAKOTA**

RATHSBURG ASSOCIATES      BLOOMINGTON, MN      952-893-1400

**OHIO**

RATHSBURG ASSOCIATES      COLUMBUS, OH      248-615-4000

**OKLAHOMA**

ELECTRA REPS      PLANO, TX      972-599-2130

**OREGON**

HALBAR-RTS, INC.      BEAVERTON, OR      503-624-5741

**PENNSYLVANIA**

ASTROREP MID-ATLANTIC, INC. (EAST)      DOYLESTOWN, PA      267-880-6321  
RATHSBURG ASSOCIATES (WEST)      PITTSBURGH, PA      248-615-4000

**PUERTO RICO**

CBX ELECTRONICS      ALTAMONTE SPRINGS, FL      407-774-9100

**RHODE ISLAND**

CONTI-YOUNGER ASSOCIATES      MARLBORO, MA      508-485-7204

**SOUTH CAROLINA**

CARTWRIGHT & BEAN, INC.      CHARLOTTE, NC      800-242-5876

**SOUTH DAKOTA**

RATHSBURG ASSOCIATES      BLOOMINGTON, MN      952-893-1400

**TENNESSEE**

CARTWRIGHT & BEAN (EAST)      NORCROSS, GA      800-242-5876  
CARTWRIGHT & BEAN (WEST)      HUNTSVILLE, AL      800-242-5876

**TEXAS**

ELECTRA REPS      PLANO, TX      972-599-2130  
ELECTRA REPS      AUSTIN      512-249-1101  
ELECTRA REPS      HOUSTON      281-516-1122  
LUSCOMBE ENGINEERING (EL PASO)      EL PASO, TX      602-678-1955

**UTAH**

STRAUBE ASSOCIATES ROCKY MOUNTAINS, INC.      WESTMINSTER, CO      303-426-0890

**VERMONT**

CONTI-YOUNGER ASSOCIATES      MARLBORO, MA      508-485-7204

**VIRGINIA**

ASTROREP MID-ATLANTIC, INC.      DOYLESTOWN, PA      267-880-6321

**WASHINGTON**

HALBAR-RTS, INC.      KIRKLAND, WA      425-893-8400

**WEST VIRGINIA**

RATHSBURG ASSOCIATES      COLUMBUS, OH      248-615-4000

**WISCONSIN**

RATHSBURG ASSOCIATES      MUSKEGO, WI      262-679-8250  
RATHSBURG ASSOCIATES      HARTFORD, WI      262-670-6513

**WYOMING**

STRAUBE ASSOCIATES ROCKY MOUNTAINS, INC.      WESTMINSTER, CO      303-426-0890

**Authorized Corcom Product Distributors and Resellers**

|   |  |
|---|--|
| <p><b>All American</b><br/>www.allamerican.com<br/>1-800-573-ASAP</p>   | <p><b>Hammond Electronics</b><br/>www.hammondelec.com<br/>1-800-929-2677</p>                             |
| <p><b>Allied Electronics, Inc.</b><br/>www.alliedelec.com<br/>1-800-433-5700</p>                              | <p><b>Heilind Electronics</b><br/>www.heilind.com<br/>1-800-400-7041</p>                                 |
| <p><b>Arrow Electronics</b><br/>www.arrow.com<br/>1-800-777-2776</p>  | <p><b>Marsh Electronics</b><br/>www.marshelectronics.com<br/>1-800-236-8327</p>                          |
| <p><b>Avnet</b><br/>www.avnet.com<br/>US: 1-800-332-8638</p>  | <p><b>Master Distributors</b><br/>www.masterdistributors.com<br/>1-888-473-5297</p>                      |
| <p><b>Carlton Bates Company</b><br/>www.carlton-bates.com<br/>1-866-600-6040</p>                              | <p><b>Mouser Electronics</b><br/>www.mouser.com<br/>1-800-346-6873</p>                                   |
| <p><b>Digi-Key Corporation</b><br/>www.digikey.com<br/>1-800-344-4539</p>                                     | <p><b>Newark Electronics</b><br/>www.newark.com<br/>1-800-463-9275</p>                                   |
| <p><b>Electro Sonic</b><br/>www.e-sonic.com<br/>1-800-567-6642</p>  | <p><b>Norvell Electronics</b><br/>www.norvell.com<br/>1-800-893-0593</p>                                 |
| <p><b>Future Electronics</b><br/>www.futureelectronics.com<br/>US &amp; Canada: 1-800-FUTURE-1 (388-8731)</p> | <p><b>Sager Electronics</b><br/>www.sager.com<br/>1-800-SAGER-800</p>                                    |
| <p><b>Genie Group</b><br/>www.geniegroup.com<br/>1-615-771-9412</p>   | <p><b>Simcona Electronics</b><br/>www.simcona.com<br/>US: 1-800-274-6266      Canada: 1-519-652-1130</p> |
| <p><b>Gopher Electronics</b><br/>www.gopherelectronics.com<br/>1-800-592-9519</p>                             | <p><b>TTI Inc.</b><br/>www.ttiinc.com<br/>1-800-CALL-TTI</p>   |

---

## Global Contacts

### Americas

**Argentina** – Buenos Aires  
Phone: +54-11-4733-2200  
Fax: +54-11-4733-2211

**Brasil** – São Paulo  
Phone: +55-11-2103-6000  
Fax: +55-11-2103-6030

**Chile** – Santiago  
Phone: +56-2-345-0361  
Fax: +56-2-223-1477

**Canada** – Toronto  
Phone: +905-475-6222  
Fax: +905-474-5520  
Product Information Center:  
Phone: +905-470-4425  
Fax: +905-474-5525

**Colombia** – Bogota  
Phone: +57-1-319-8959  
Fax: +57-1-319-8960

**Mexico** – Mexico City  
Phone: +52-55-1106-0800  
+01-800-733-8926  
Fax: +52-55-1106-0901

**For Latin/South American  
Countries not shown**  
Phone: +54-11-4733-2015  
Fax: +54-11-4733-2083

**United States**  
Harrisburg, PA  
Phone: +1-717-564-0100  
Fax: +1-717-986-7575  
Product Information Center:  
Phone: +1-800-522-6752  
Fax: +1-717-986-7575  
Mundelein, IL  
Phone: +1-847-680-7400  
Fax: +1-847-680-8169

---

### Asia/Pacific

**Australia** – Sydney  
Phone: +61-2-9554-2600  
Fax: +61-2-9502-2556  
Product Information Center:  
Phone: +61-2-9840-8200  
Fax: +61-2-9634-6188

**India** – Bangalore  
Phone: +91-80-285-40800  
Fax: +91-80-285-40820

**Indonesia** – Jakarta  
Phone: +65-6482-0311  
Fax: +65-6482-1012

**Japan** – Kawasaki, Kanagawa  
Phone: +81-44-844-8111  
Fax: +81-44-812-3207  
Product Information Center:  
Phone: +81-44-844-8013  
Fax: +81-44-812-3200

**Korea** – Seoul  
Phone: +82-2-3415-4500  
Fax: +82-2-3486-3810

**Malaysia** – Selangor  
Phone: +60-3-7805-3055  
Fax: +60-3-7805-3066

**New Zealand** – Auckland  
Phone: +64-9-634-4580  
Fax: +64-9-634-4586

**Philippines** – Makati City  
Phone: +632-848-0171  
Fax: +632-867-8661

**People's Republic of China**  
Hong Kong  
Phone: +852-2735-1628  
Fax: +852-2735-0243  
Shanghai  
Phone: +86-21-2407-1588  
Fax: +86-21-2407-1599

**Singapore** – Singapore  
Phone: +65-6482-0311  
Fax: +65-6482-1012

**Taiwan** – Taipei  
Phone: +886-2-8768-2788  
Fax: +886-2-8768-2268

**Thailand** – Bangkok  
Phone: +66-2-955-0500  
Fax: +66-2-955-0505

**Vietnam** – Ho Chi Minh City  
Phone: +84-8-930-5546  
Fax: +84-8-930-3443

---

### Europe/Middle East/Africa

**Austria** – Vienna  
Phone: +43-1-905-60-0  
Fax: +43-1-905-60-1333  
Product Information Center:  
Phone: +43-1-905-60-1228  
Fax: +43-1-905-60-1333

**Belarus** – Minsk  
Phone: +375 17 237 47 94  
Fax: +375 17 237 47 94

**Belgium** – Kessel-Lo  
Phone: +32-16-352-300  
Fax: +32-16-352-355

**Bulgaria** – Sofia  
Phone: +359-2-971-2152  
Fax: +359-2-971-2153

**Czech Republic and Slovakia**  
**Czech Republic** – Kurim  
Phone: +420-541-162-111  
Fax: +420-541-162-223  
Product Information Center:  
Phone: +420-541-162-113  
Fax: +420-541-162-104

**Denmark** – Glostrup  
Phone: +45-43-48-04-00  
Fax: +45-43-44-14-14

**Egypt** – Cairo  
Phone: +202-419-2334  
Fax: +202-417-7647

**Estonia** – Tartu  
Phone: +372-5138-274  
Fax: +372-7400-779

**Finland** – Helsinki  
Phone: +358-95-12-34-20  
Fax: +358-95-12-34-250

**France** – Cergy-Pontoise Cedex  
Phone: +33-1-3420-8888  
Fax: +33-1-3420-8600  
Product Information Center:  
Phone: +33-1-3420-8686  
Fax: +33-1-3420-8623

**France Export Divisions** –  
Cergy-Pontoise Cedex  
Phone: +33-1-3420-8804  
Fax: +33-1-3420-8699

**Germany** – Bensheim  
Phone: +49-6251-133-0  
Fax: +49-6251-133-1600  
Product Information Center:  
Phone: +49-6251-133-1999  
Fax: +49-6251-133-1988

**Greece** – Athens  
Phone: +30-210-9370-  
396/397  
Fax: +30-210-9370-655

**Hungary** – Budapest  
Phone: +36-1-289-1000  
Fax: +36-1-289-1010  
Product Information Center:  
Phone: +36-1-289-1016  
Fax: +36-1-289-1017

**Ireland** – Dublin  
Phone: +353-1-866-5612  
Fax: +353-1-866-5714

**Israel** – Petach-Tikva  
Phone: +972-3-929-0999  
Fax: +972-3-919-1088

**Italy** – Collegno (Torino)  
Phone: +39-011-4012-111  
Fax: +39-011-4031-116  
Product Information Center:  
Phone: +39-011-4012-632  
Fax: +39-011-40-287-632

**Lithuania and Latvia**  
**Lithuania** – Vilnius  
Phone: +370-5-213-1402  
Fax: +370-5-213-1403  
Product Information Center:  
Phone: +370-5-211-3016  
Fax: +370-5-213-1403

**Netherlands** –  
's-Hertogenbosch  
Phone: +31-73-6246-246  
Fax: +31-73-6212-365  
Product Information Center:  
Phone: +31-73-6246-999  
Fax: +31-73-6246-998

**Norway** – Nesbru  
Phone: +47-66-77-88-50  
Fax: +47-66-77-88-55

**Poland** – Warsaw  
Phone: +48-22-4576-700  
Fax: +48-22-4576-720  
Product Information Center:  
Phone: +48-22-4576-704  
Fax: +48-22-4576-720

**Romania** – Bucharest  
Phone: +40-21-311-3479/3596  
Fax: +40-21-312-0574  
**Russia** – Moscow  
Phone: +7-495-790-7902  
Fax: +7-495-721-1893  
Product Information Center:  
Phone: +7-495-790-7902-404  
Fax: +7-495-790-7902-401

**Russia** – St. Petersburg  
Phone: +7-812-718-8192  
Fax: +7-812-718-8193

**Slovenia** – Ljubljana  
Phone: +386-1561-3270  
Fax: +386-1561-3240

**South Africa** – Port Elizabeth  
Phone: +27-41-503-4500  
Fax: +27-41-581-0440

**Spain** – Barcelona  
Phone: +34-93-291-0330  
Fax: +34-93-201-7879

**Sweden** – Upplands Väsby  
Phone: +46-8-50-72-50-00  
Fax: +46-8-50-72-50-01

**Switzerland** – Steinach  
Phone: +41-71-447-0447  
Fax: +41-71-447-0444

**Turkey** – Istanbul  
Phone: +90-212-281-8181/2/3  
+90-212-282-  
5130/5430  
Fax: +90-212-281-8184

**Ukraine** – Kiev  
Phone: +380-44-206-2265  
Fax: +380-44-206-2264  
Product Information Center:  
Phone: +380-44-206-2265  
Fax: +380-44-206-2264

**United Kingdom** –  
Stanmore, Middlesex  
Phone: +44-8706-080208  
Fax: +44-208-954-6234  
Product Information Center:  
Freephone (UK only):  
+0800-267-666  
Phone: +44-8706-080208  
Fax: +44-208-420-8095

## FOR MORE INFORMATION

[te.com/industry/commercial-building-technology](http://te.com/industry/commercial-building-technology)  
[corcom.com](http://corcom.com)

### TE Technical Support Center

|                   |  |
|-------------------|--|
| Internet:         | <a href="http://te.com/help">te.com/help</a> |
| USA:              | +1 (800) 522-6752                            |
| Canada:           | +1 (905) 475-6222                            |
| Mexico:           | +52 (0) 55-1106-0800                         |
| Latin/S. America: | +54 (0) 11-4733-2200                         |
| Germany:          | +49 (0) 6251-133-1999                        |
| UK:               | +44 (0) 800-267666                           |
| France:           | +33 (0) 1-3420-8686                          |
| Netherlands:      | +31 (0) 73-6246-999                          |
| China:            | +86 (0) 400-820-6015                         |

Part numbers in this brochure are RoHS Compliant\*, unless marked otherwise.

\*as defined [www.te.com/leadfree](http://www.te.com/leadfree)

**te.com**  
**corcom.com**

© 2011 Tyco Electronics Corporation, a TE Connectivity Ltd. company. All Rights Reserved.  
1654001 CIS JG 06/2011

Corcom, TE Connectivity, TE connectivity (logo) and TE (logo) are trademarks. Other logos, product and/or company names might be trademarks of their respective owners.

While TE has made every reasonable effort to ensure the accuracy of the information in this brochure, TE does not guarantee that it is error-free, nor does TE make any other representation, warranty or guarantee that the information is accurate, correct, reliable or current. TE reserves the right to make any adjustments to the information contained herein at any time without notice. TE expressly disclaims all implied warranties regarding the information contained herein, including, but not limited to, any implied warranties of merchantability or fitness for a particular purpose. The dimensions in this catalog are for reference purposes only and are subject to change without notice. Specifications are subject to change without notice. Consult TE for the latest dimensions and design specifications.

