



Operator's Manual

WaveLink Series Differential Probe (13-25 GHz)



WaveLink Series Differential Probe (13-25 GHz)

Operator's Manual

November, 2012



TELEDYNE LECROY
Everywhereyoulook™



TELEDYNE LECROY
Everywhereyoulook™

700 Chestnut Ridge Road
Chestnut Ridge, NY, 10977-6499
Tel: (845) 425-2000, Fax: (845) 578 5985
teledynelecroy.com

WaveLink Series Differential Probe (13-25 GHz) Operator's Manual
© 2012 Teledyne LeCroy. All rights reserved.

Unauthorized duplication of Teledyne LeCroy documentation materials other than for internal sales and distribution purposes is strictly prohibited. However, clients are encouraged to distribute and duplicate Teledyne LeCroy documentation for their own internal educational purposes.

Teledyne LeCroy and other product or brand names are trademarks or requested trademarks of their respective holders. Information in this publication supersedes all earlier versions. Specifications are subject to change without notice.

WARRANTY

Teledyne LeCroy warrants this oscilloscope accessory for normal use and operation within specification for a period of one year from the date of shipment. Spare parts, replacement parts and repairs are warranted for 90 days.

In exercising its warranty, Teledyne LeCroy, at its option, will either repair or replace any assembly returned within its warranty period to the Customer Service Department or an authorized service center. However, this will be done only if the product is determined by Teledyne LeCroy's examination to be defective due to workmanship or materials, and the defect is not caused by misuse, neglect, accident, abnormal conditions of operation, or damage resulting from attempted repair or modifications by a non-authorized service facility.

The customer will be responsible for the transportation and insurance charges for the return of products to the service facility. Teledyne LeCroy will return all products under warranty with transportation charges prepaid.

This warranty replaces all other warranties, expressed or implied, including but not limited to any implied warranty of merchantability, fitness or adequacy for any particular purposes or use. Teledyne LeCroy shall not be liable for any special, incidental, or consequential damages, whether in contract or otherwise.

WL-HBW-A-OM-E Rev B
921475-00 Rev A

TABLE OF CONTENTS

Introduction	1
Modular Advantage	2
Modular Probe Components	4
Platform/Cable Assembly	4
Differential Amplifier Small Tip Modules	7
Solder-in Interconnect Leads	10
Positioner Tip (Browser).....	11
Complete Probe System (PS).....	12
Probe Operation	14
Overview	14
System Calibration	14
De-Embedding Probes.....	15
Handling the Probe	16
Connecting the Platform/Cable Assembly, Amplifier Module, and Interconnect Lead...	16
Connecting the Probe to a Teledyne LeCroy Oscilloscope.....	18
Operation with a Teledyne LeCroy Oscilloscope.....	19
Connecting the Probe to the Test Circuit.....	22
Positioning of the Input Leads.....	27
AutoColor ID and Power Control Indicators.....	28
AutoZero.....	29
Accessory Use	29
Positioning Tools	29
Probe Deskew Fixtures.....	38
Care and Maintenance	39
Cleaning.....	39
Replacing Damping Resistors on the Solder-in Interconnect Lead	39
Correctly Replacing Carbon Composite Resistive Pogo-Pin Tips in Dxx05-PT.....	42
Service Strategy.....	46
Returning a Product for Calibration or Service	46

WaveLink Series Differential Probe (13-25 GHz)

Returning a Product to a Different Country	48
Consumables and Replacement Parts	48
Service Options	53
Functional Test	54
Functional Test Overview	54
Test Setup	54
Performance Verification	58
Performance Verification Overview	58
Required Test Equipment	59
Preliminary Procedure	61
Verification Procedure	62
DC Frequency Attenuation Accuracy	64
Connecting SI Interconnect Leads to the Fixture.....	66
Quick Functional Check.....	68
Performance Verification Test Record.....	70
Reference Material	72
Specifications	72
Regional Service Centers	72
Safety Instructions	73
Certifications.....	74
Probe Input Impedance and Loading.....	77
Differential Mode and Common Mode	81
Differential Mode Range and Common Mode Range	81
Common Mode Rejection Ratio	83
Offset	84
Dynamic Range	84
Index	85

Introduction

Teledyne LeCroy's WaveLink 13-25 GHz Differential Probes utilize the latest design techniques and components to achieve very high bandwidth, exceptional system (probe with oscilloscope) rise times, low electrical noise, and high impedance over a wide frequency range. This is possible through the use of a high bandwidth traveling wave (distributed) amplifier with high gain and low noise, interconnect lead and tip designs that provide high impedance over a broad range of frequencies, which reduces loading on the device under test, and lead/tip construction that enables a nearly ideal terminating resistor to be located as close to the circuit as possible for superior performance.

The WaveLink Series of High Bandwidth Differential Probes also utilize digital filtering to optimize the system frequency response. The design of the WaveLink probe amplifier is such that there is a very wide bandwidth response that exceeds the oscilloscope bandwidth. At time of initial shipment, each probe undergoes a rigorous calibration and performance verification process that results in a stored response file on-board the probe. When the probe is connected to a Teledyne LeCroy oscilloscope, the probe and oscilloscope responses are optimized to each other to provide a probe + oscilloscope response identical to that of the raw oscilloscope channel. Teledyne LeCroy has provided this capability since the introduction of the first WaveLink probes in 2003. All that is left for the operator is to de-embed the probe loading from the circuit using Teledyne LeCroy's Virtual Probe software option, if desired. Since the Teledyne LeCroy probe impedance is very high across the passband, this may not even be necessary.

Teledyne LeCroy's WaveLink 13-25 GHz Differential Amplifier Small Tip Modules utilize either a Dxx05 or Dxx05-A amplifier. The two amplifier series differ only in the Input Dynamic Range specification – Dxx05 permit a 1.6Vp-p absolute signal swing and Dxx05-A permit a 2.0Vp-p signal swing with specifications guaranteed and 2.4Vp-p max operating window. Otherwise, the operation of the unit is identical, and this Operator's Manual is used for either series. The same tips and leads are compatible with both amplifier series.

To learn more about this probe series, **Contact Teledyne LeCroy for Support.**

NOTE:

- A Certificate of Calibration is supplied with each probe indicating the system meets the specifications with those components listed in the Certificate.
- Download the latest version of X-Stream software to run your WaveLink probe with maximum performance.

Modular Advantage

These probes use a pioneering modular design first introduced by Teledyne LeCroy's initial WaveLink product releases. The modular design consists of a **Platform/Cable Assembly, Differential Amplifier Small Tip Module with Solder-in Leads, or Positioner Tip (Browser)**.

You may order nearly any combination of Platform/Cable Assembly and Amplifier Module (supplied with Interconnect Leads) depending on the oscilloscope you have and your requirements. At time of shipment, Teledyne LeCroy serializes the individual components and calibrates them as a system. To achieve maximum performance and warranted specifications, the components should be used together, as serialized. If additional Interconnect Leads or other components are purchased, you may return the serialized system to Teledyne LeCroy for re-calibration to ensure performance.

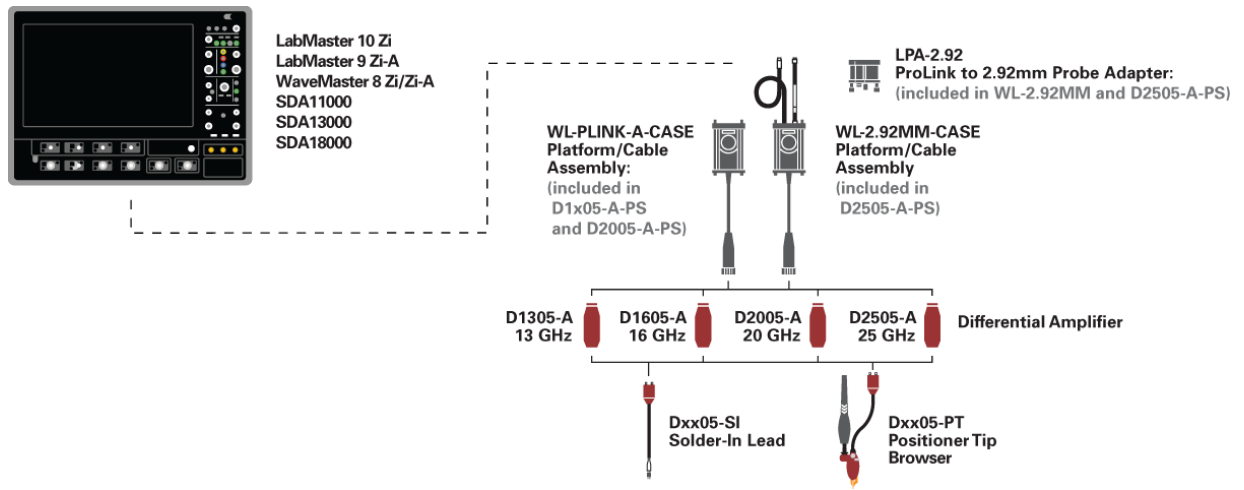

WaveLink Dxx05 Probe Family

Standard Accessories	WL-PLINK-A-CASE WL-2.92MM-CASE	Dxx05-A	Dxx05-A-PS	Dxx05-PT-KIT
Amplifier System				
Amplifier	-	1 each	1 each	-
Solder-in Lead Set	-	2 each	2 each	-
Spare Damping Resistors for SI Tip	-	10 each	10 each	-
Tip Retaining Clip for SI Leads	-	2 each	2 each	-
Adhesive Tape	-	1 set	1 set	-
Ground Lead	-	1 each	1 each	-
Ground Clip	-	1 each	1 each	-
Instruction Manual	-	1 each	1 each	-
Accessory Info Sheet & Quick Start Guide	-	1 each	1 each	-
Positioner Tip with Accessories				
Positioner Tip (Browser)	-	-	1 each	1 each
Replacement Pogo Pins for Dxx05-PT	-	-	1 set	1 set
Positioner Tip Probe Guides	-	-	1 each	1 each
XYZ Positioner	-	-	1 each	1 each
Adhesive Tape for XYZ Positioner	-	-	1 set	1 set
Browser Wand for PT Tip	-	-	1 each	1 each
Interlock Pieces for PT Tip	-	-	1 each	1 each
Swivel for PT Tip	-	-	1 each	1 each
Platform/Cable Assembly Kit				
Platform/Cable Assembly	1 each	-	1 each	-
Freehand Probe Holder	1 each	-	1 each	-
Probe Deskew Fixture	1 each	-	1 each	-
Platform/Cable Assembly Mounting Clip	1 each	-	1 each	-
Probe Cable Clamp	2 each	-	2 each	-
ESD Wrist Strap	1 each	-	1 each	-
Performance Verification Certificate	1 each	-	1 each	-
ProLink to 2.92mm Probe Adapter (WL-2.92MM-CASE and D2505-A-PS only)	1 each	-	1 each	-
Deluxe Soft Carrying Case	1 each	-	1 each	-

WaveLink Series Differential Probe (13-25 GHz)

Standard Accessories	WL-PLINK-A-CASE WL-2.92MM-CASE	Dxx05-A	Dxx05-A-PS	Dxx05-PT-KIT
Foam Insert for Carrying Case	1 each	-	1 each	-
Protective Storage Case	1 each	-	1 each	-
Plastic Tray for Storage Case	1 each	-	1 each	-

NOTE: While the amplifiers can be used with either platform/cable assembly, system bandwidth is limited to the lowest bandwidth component. System calibration is required for all interconnected components to guarantee system performance. Typically, a customer purchases a single Platform/Cable Assembly that matches the Amplifier Module bandwidth rating.

Modular Probe Components

Platform/Cable Assembly

This piece forms the foundation of the probe and provides an attachment for the probe amplifier to the oscilloscope. There are two different platform/cable assemblies available depending on whether you are connecting to ProLink inputs currently used on ≥ 4 GHz Teledyne LeCroy WaveMaster 8 Zi/Zi-A models, or to 2.92mm inputs used for 25-36 GHz signals on Teledyne LeCroy WaveMaster 8 Zi-A, LabMaster 9 Zi-A, and LabMaster 10 Zi models.

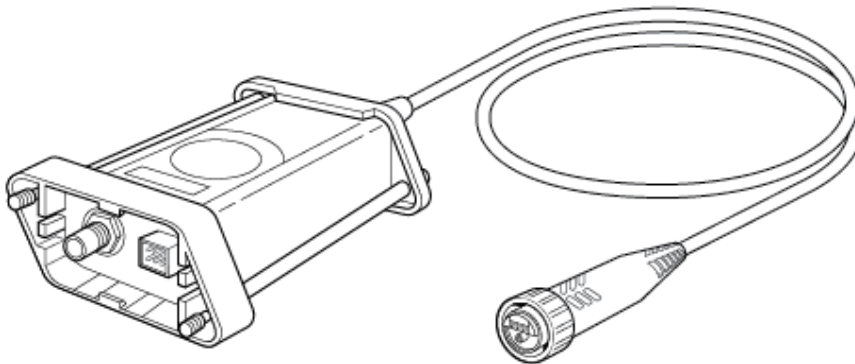

Platform/cable assembly provided with WL-PLINK-A-CASE

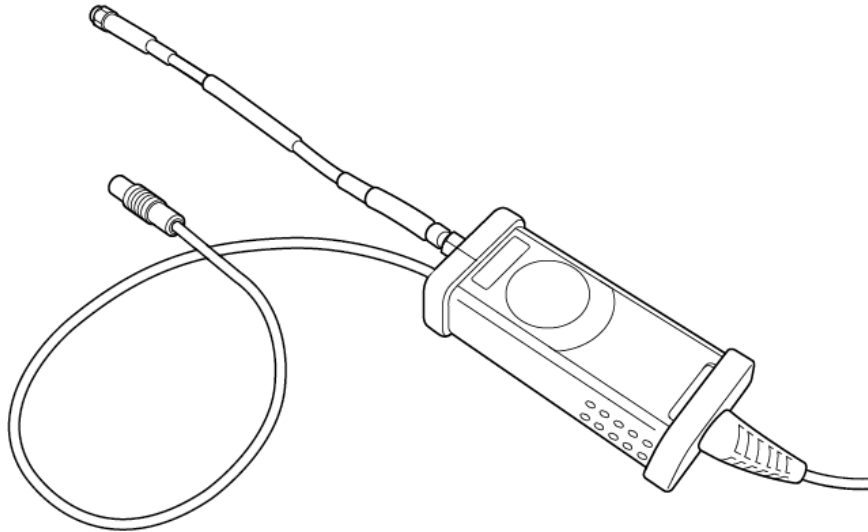

Platform/cable assembly provided with WL-2.92MM-CASE

The Platform/Cable Assembly performs the following important functions:

- It provides power to the probe amplifier from the oscilloscope.
- It communicates to the oscilloscope the identifying characteristics of the amplifier that is connected to the probe so that the oscilloscope channel can be set to the correct probe attenuation value automatically. Software prompts you to specify the type of tip connected to the amplifier when this occurs.
- It transmits the amplifier output signal along a well-defined low loss transmission line into the oscilloscope input, and terminates the probe appropriately at that point.

NOTE: Legacy WL-PLINK platform/cable assemblies are not compatible with the D1x05-A or D2x05-A 13+ GHz amplifier modules. Only the WL-PLINK-A or WL-2.92MM are compatible.

WaveLink Series Differential Probe (13-25 GHz)

Platform/Cable Assembly	Product Code
WaveLink ProLink Platform/Cable Assembly	WL-PLINK-A-CASE
WaveLink 2.92mm Platform/Cable Assembly	WL-2.92MM-CASE



LPA-2.92 mm to ProLink Probe Adapter

This adapter provides a simple and effective method to convert a Teledyne LeCroy ProLink interface to a Teledyne LeCroy 2.92mm interface.



Teledyne LeCroy's 2.92mm interface utilizes a 2.92mm connector for the signal, and a LEMO connection for probe power and communication. This interface is used for >20 GHz and <=36 GHz inputs on Teledyne LeCroy oscilloscopes.

Teledyne LeCroy's ProLink interface utilizes a blind-mate adapter (BMA) connector for the signal and 6-pin connection for probe power and communication.

In order to better leverage the complete probe system amongst all possible input types, the LPA-2.92 may be used to adapt a WL-2.92MM platform/cable assembly to a ProLink connection - saving you from having to purchase of an additional type of Platform/Cable Assembly. This adapter is included standard with the WL-2.92MM-CASE.

Differential Amplifier Small Tip Modules

This module contains the active amplifier circuitry and performs the important task of amplifying the low-level signal at the probe tip for transmission to the oscilloscope via the Platform/Cable Assembly.

For this 13-25 GHz probe series, Teledyne LeCroy utilizes advanced differential distributed (traveling wave) amplifier architecture to achieve superior high frequency broadband performance. A distributed amplifier uses a transmission line to provide inputs to a series of amplification stages. Another parallel transmission line is used to sum the outputs of each amplification stage. The two transmission lines are designed with specific delay and impedance characteristics to ensure that the amplification stages are summed correctly. Since the amplifier gain stages add rather than multiply (as in a typical cascade design), it is possible to achieve high gain over a wide frequency range with very low inherent noise. This provides the added benefit of a lower probe attenuation, which enables the oscilloscope to be operating in an input range which itself requires lower gain, and hence will typically have lower noise. In addition, higher bandwidths can typically be achieved with this amplifier architecture. Since a pure distributed amplifier provides insufficient low frequency response, an additional amplifier is integrated into the assembly for this purpose.

Amplifier Modules (includes solder-in interconnect leads)	Product Code
<p>13 GHz WaveLink</p> <p>13GHz, 2.0Vp-p, $\pm 2.5V$ Offset Range, and $\pm 4V$ Common Mode Range Amplifier Module with Dxx05-SI Solder-in Lead (Qty. 2). Also Includes: Replacement Resistors (Qty. 10), Tip Retaining Clips (Qty. 2), and Protective Storage Case.</p> <p>Must be ordered with a WL-PLINK-A-CASE Platform/Cable Assembly to achieve warranted calibration. If desired, this Amplifier Module may also be used with a WL-2.92MM-CASE Platform/Cable Assembly with a 13 GHz bandwidth limitation. All amplifier modules and platform/cable assemblies must be calibrated as a system at time of shipment.</p>	D1305-A
<p>16 GHz WaveLink</p> <p>16 GHz, 2.0Vp-p, $\pm 2.5V$ Offset Range, and $\pm 4V$ Common Mode Range Amplifier Module with Dxx05-SI Solder-in Lead (Qty. 2). Also Includes: Replacement Resistors (Qty. 10), Tip Retaining Clips (Qty. 2), and Protective Storage Case.</p> <p>Must be ordered with a WL-PLINK-A-CASE Platform/Cable Assembly to achieve warranted calibration. If desired, this Amplifier Module may also be ordered with a WL-2.92MM-CASE Platform/Cable Assembly with a 16 GHz bandwidth limitation. All amplifier modules and platform/cable assemblies must be calibrated as a system at time of shipment.</p>	D1605-A
<p>20 GHz WaveLink</p> <p>20GHz, 2.0 Vp-p, $\pm 2.5V$ Offset Range, and $\pm 4V$ Common Mode Range Amplifier Module with Dxx05-SI Solder-in Lead (Qty. 2). Also Includes: Replacement Resistors (Qty. 10), Tip Retaining Clips (Qty. 2), and Protective Storage Case.</p> <p>Must be ordered with a WL-PLINK-A-CASE Platform/Cable Assembly to achieve warranted calibration. If desired, this Amplifier Module may also be ordered with a WL-2.92MM-CASE Platform/Cable Assembly with a 20 GHz bandwidth limitation. All amplifier modules and platform/cable assemblies must be calibrated as a system at time of shipment.</p>	D2005-A
<p>25 GHz WaveLink</p> <p>25GHz, 2.0Vp-p, $\pm 2.5V$ Offset Range, and $\pm 4V$ Common Mode Range Amplifier Module with Dxx05-SI Solder-in Lead (Qty. 2). Also Includes: Replacement Resistors (Qty. 10), Tip Retaining Clips (Qty. 2), and Protective Storage Case.</p> <p>Must be ordered with a WL-2.92MM-CASE 25 GHz Platform/Cable Assembly to achieve warranted calibration.</p> <p>May also be used with a WL-PLINK-A-CASE Platform/Cable Assembly but will achieve lesser bandwidth. All amplifier modules and platform/cable assemblies must be calibrated as a system at time of shipment.</p>	D2505-A

Solder-in Interconnect Leads

The probe lead provides ability to access the signal on the device under test (DUT) without disturbing the operation of the DUT. The solder-in probe lead provides the highest possible performance at the expense of a non-movable installation. The design of the solder-in lead minimizes customer circuit loading with the probe connected by providing high probe AC loading and a wide frequency range where AC circuit loading is minimized.

The solder-in lead supplied with the kit consists of two small, pre-installed and pre-trimmed attenuating (damping) resistors connected to a flexible transmission line terminating in a connector mating with the amplifier. Because resistors and resistor lengths are small, this solder-in lead provides the maximum signal fidelity and minimum circuit loading at the highest frequencies. The resistors are soldered directly into the connection points of the circuit under test, providing a reliable, intermittence-free connection.

Five replacement damping resistors are provided with each solder-in lead. Resistors may be replaced in the field if the tip is damaged. See **Replacing Damping Resistors on the Solder-in Interconnect Lead** (on page 39) for more information.

NOTE:

- At initial product launch, there were two different solder-in leads - a D1x05-SI and a D2005-SI. The D2005-SI was used with the 20 GHz and the D1x05-SI was used with 13 and 16 GHz amplifiers.
- Now, these solder-in leads have been replaced with a universal Dxx05-SI used for all bandwidths (13-25 GHz). This lead can also be used as a replacement for the D1x05-SI and D2005-SI.

Teledyne LeCroy's solder-in probe lead uses resistors at the tip that are precisely pre-cut to the correct length. This design provides the following advantages:

- It locates the damping resistance of the probe tip as close to the DUT as possible.
- It eliminates the need for long lengths of wire between the DUT and the damping resistor, which impacts loading and frequency response. The resistors may still be spaced as desired to connect to a wide variety of circuits.
- It eliminates the need to precision cut and solder small lengths of wire to the end of the solder-in lead, and then solder these wires to the DUT.
- The damping resistors are easily replaced in the field to provide maximum serviceability and life of the solder-in probe lead.

Positioner Tip (Browser)

The **Positioner Tip (Browser)** provides the ability to access the signal on the DUT without permanently attaching a lead or other device to the DUT. The positioner tip combines high performance with quick access to a variety of probe points when it's used as a hand-held browser (using the **Wand** attachment) or as a fast and convenient method to re-position a fixed test point (using a positioner tool, like Teledyne LeCroy's **Freehand Positioner**, **XYZ Positioner** or **EZ Probe** . The carbon composite resistive pogo pin tips are adjustable from 0 to 3.5 mm (0 to 0.14") and have 0.55 mm (0.022") of Z-Axis compliance. Because of its thin form factor and spring-loaded tips, it is ideally suited for use with multiple probes in tight areas such as the back side of boards with ball-grid array packaged ICs.

The Positioner Tip supplied with the kit consists of two small, pre-installed carbon-composite resistive pogo-pin tips with crowned metal caps for solid connection to the circuit. The carbon composite resistive tips place the tip resistance as close to the circuit as possible. In addition, the nature of the material and design minimizes skin effect at higher frequencies, a common problem with a single conductive tip. The Positioner Tip provides the maximum signal fidelity and minimum circuit loading at the highest frequencies.

Care should be taken when using the Positioner Tip. While the carbon composite material in the tip is very strong, the high bandwidth nature of the probe means the diameter must be very small. Avoid lateral motion against the circuit trace with the tip, and do not exceed the pogo pin Z-Axis compliance.

NOTE: Some mechanical positioners (such as the EZ Probe) might have the capability to exert excessive Z-Axis compliance during setup, so be extra careful with these types of mechanical positioners.

Two replacement resistive tips are provided with the Positioner Tip. These tips may be replaced in the field if the tip is damaged. See **Correctly Replacing Carbon Composite Resistive Pogo-Pin Tips in Dxx05-PT** (on page 42) for more information.

WaveLink Series Differential Probe (13-25 GHz)



Positioner Tip (Browser) Kit

Positioner Tip (Browser) Kit (includes tip and accessories)	Product Code
WaveLink Dxx05-PT (20 GHz rating) Adjustable Positioner Tip Kit. For use with D1305-A, D1605-A, D2005-A, and D2505-A amplifiers. Includes XYZ Positioner Assembly with Mechanical Interconnects, Adhesive Kit, Connection Guides, Hand-held Wand, and replacement Carbon Composite Pogo-Pin Tips (Qty. 2).	Dxx05-PT-KIT

Complete Probe System (PS)

By design, the WaveLink probes are modular in nature. However, to make selection easy, a complete probe system is available for purchase. These probe systems are all-inclusive and contain the following items:

- Platform/Cable Assembly Kit
- LPA-2.92 to ProLink Adapter (25 GHz kits only)
- Amplifier System (with SI Lead Set)
- Positioner Tip (Browser) Kit

Just choose the appropriate bandwidth (13, 16, 20, or 25 GHz) for the probe system.

NOTE: The 25 GHz probe system Positioner Tip (Browser) is rated to 20 GHz (guaranteed) and 22 GHz (typical).



Complete Probe System (PS)

Standard Accessories	D1x05-A-PS	D2005-A-PS	D2505-A-PS
WL-PLINK-A-CASE Platform/Cable Assembly Kit	1 each	1 each	
WL-2.92MM-CASE Platform/Cable Assembly Kit			1 each
LPA-2.92 to ProLink Adapter			1 each
D1x05-A Amplifier System	1 each		
D2x05-A Amplifier System		1 each	1 each
Dxx05-PT-KIT Positioner Tip (Browser) Kit	1 each	1 each	1 each

Probe Operation

Overview

Teledyne LeCroy WaveLink probes are factory calibrated and performance verified on shipment. During factory calibration and performance verification, each probe amplifier has a response file created and stored on-board. When the probe is connected to your Teledyne LeCroy oscilloscope, the response file is read by your oscilloscope and a combined optimized probe + oscilloscope response is created for your particular oscilloscope and channel to which the probe is connected. The response is identical to that of the oscilloscope channel.

All that is left for the operator is to de-embed the probe loading from the circuit using Teledyne LeCroy's Virtual Probe software option, if desired. Since the Teledyne LeCroy probe impedance is very high across the passband, this may not even be necessary.

NOTE: With your probe set up and system turned on, allow for a 15-minute warm-up of your probe prior to use. A properly warmed-up probe ensures optimal measurements.

System Calibration

By design, the D1305-A, D1605-A, D2005-A, and D2505-A amplifier modules and interconnect leads deliver the specified performance when interchanged on a WL-PLINK-A or WL-2.92MM platform/cable assembly, or when an LPA-2.92-PLINK probe adapter is used.

Each configured probe is shipped with a Certificate of Calibration indicating that the system performance was validated and found to meet or exceed the warranted specifications with those models and accessories listed in the Certificate.

As only this configuration was validated, the certificate is only valid for the configuration indicated. This is why all modular probe components are serialized, calibrated, and tested as a system before being shipped from the Teledyne LeCroy factory, to ensure guaranteed performance.

A serial number is affixed to each module and the operator must ensure serial numbers on all modules match.

NOTE: If you do not verify that serial numbers on the modules match, performance is not guaranteed. If an incorrect, uncalibrated combination of amplifier modules and platform/cable assemblies is connected together, a warning will be displayed on the oscilloscope screen.

The interconnect tips are designed to keep response within a narrow range so they are interchangeable, and interconnect leads manufactured at the same time have nearly identical performance. Likewise, if a damping resistor on the solder-in lead is replaced using the procedure

for **Replacing Damping Resistors on the Solder-in Interconnect Lead** (on page 39), performance is still guaranteed. If an interconnect lead tip is damaged beyond field repair and requires factory replacement, Teledyne LeCroy recommends you return the probe platform/cable assembly and amplifier module to the factory for a complete calibration and test to ensure guaranteed performance. This is because there may be small differences in performance of interconnect leads supplied at different times.

If a positioner tip (PT) is purchased at time of original shipment of the other probe components, this is also calibrated and serialized with the other components. If it is purchased at a later date and you have provided Teledyne LeCroy with the original probe serial number the tip is used with, Teledyne LeCroy calibrates the positioner tip to your existing components and supplies a file on a USB memory stick for installation on your oscilloscope. Follow the instructions provided with the file and memory stick in order to load this file and ensure proper calibrated performance with your existing probe components.

Finally, if the carbon composite resistive pogo-pins need to be changed on your PT tip, see **Correctly Replacing Carbon Composite Resistive Pogo-Pin Tips in Dxx05-PT** (on page 42) for more information.

De-Embedding Probes

Teledyne LeCroy probes are calibrated at the factory using a Vector Network Analyzer (VNA) to measure a system (probe plus test fixture) frequency response. The test fixture is de-embedded from the measurement using Teledyne LeCroy's Eye Doctor tools so the remaining frequency response is due to the combination of the test signal and the probe loading on the test circuit. The system frequency response is then calculated for these remaining circuit elements.

Since the WaveLink probe impedance is high, the effect of probe loading is greatly reduced and the impact on circuit measurement is much lower than when using a probe with lower impedance. However, if you wish to de-embed the effect of probe loading on your circuit, you can also use Teledyne LeCroy's Virtual Probe option. This option allows you to select the probe tip from a list of supported tips. Your selection applies a corresponding s-parameter file that is derived from the equivalent circuit model of the tip.

Handling the Probe

The WaveLink series probe is a precision test instrument. Exercise care when handling and storing the probe. Always handle the probe by the platform/cable assembly. Avoid putting excessive strain on any cable or interconnect lead or exposing the probe cables to sharp bends.



ESD Sensitive: The tips of the probe are sensitive to Electrostatic Discharge (ESD). Avoid causing damage to the probe by always following anti-static procedures (wear wrist strap, etc.) when using or handling the probe.



Solder-in Tips: Prevent damage to the solder-in tips by carefully storing them in the plastic protective storage case when not in use.

Positioner Tip: The PT tips are very small and are fragile. When not in use, store in the provided case.

Connecting the Platform/Cable Assembly, Amplifier Module, and Interconnect Lead

Follow these instructions to properly connect the main probe components.

Connecting an Amplifier Module to a Platform/Cable Assembly

Attach an Amplifier Module to the Platform/Cable Assembly by aligning the connectors of the module with the receptacles in the platform/cable assembly and pressing the two together. Be sure to finger-tighten the assembly by rotating the threaded collar onto the module.

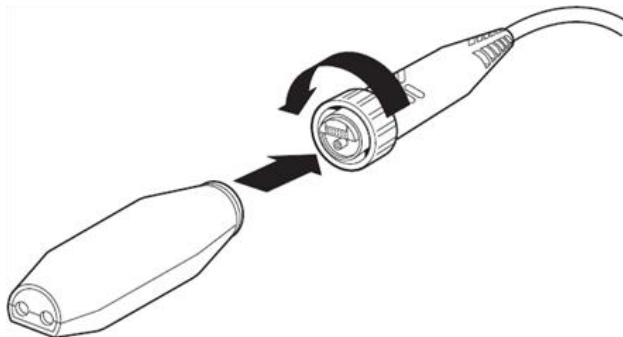

Connecting the Amplifier Module to the Platform/Cable Assembly



Do not use pliers or any other tools to tighten the collar. Remove the Amplifier Module by loosening the threaded collar from the module and pulling the two assemblies apart.

By design, the amplifier module works with the WL-PLINK-A or WL-2.92MM platform/cable assembly and either the Dxx05-SI Lead or Dxx05-PT Tip .

Connecting an Amplifier Module to an Interconnect Lead

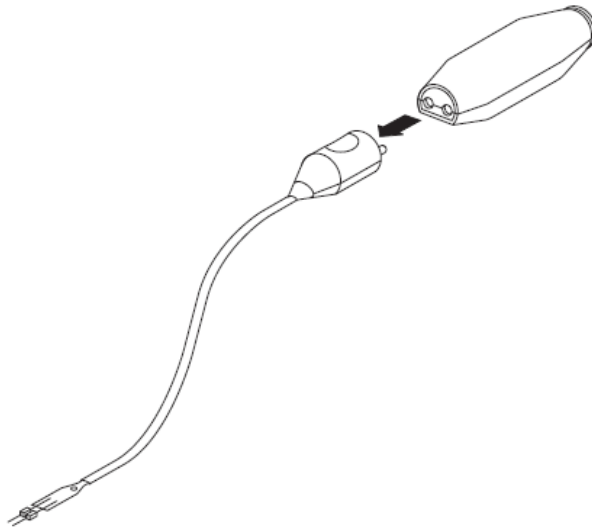

Connecting a solder-in interconnect lead to an amplifier module. The positioner tip and other leads connect in the same manner.

Align the flat side of the lead with the flat side of the amplifier module and press together.

NOTE:

- Although interconnect leads for the D1305-A, D1605-A, D2005-A, and D2505-A mechanically mate with any module, they are only compatible with a Dxx05 or Dxx05-A. No damage results; however, performance may be reduced when switching leads between modules, and the response is not calibrated. Be sure to only use leads with serial numbers that match with the differential amplifier module.
- Different colors indicate different bandwidths and/or product classes. Avoid accidental interchanging by matching the color coding of the interconnect lead tip housing with the color of the corresponding amplifier module.

Connecting the Probe to a Teledyne LeCroy Oscilloscope

The WL-PLINK-A platform/cable assembly has been designed for use with the ProLink interface of Teledyne LeCroy's LabMaster 9 Zi-A, WaveMaster 8 Zi/Zi-A, SDA/DDA 8 Zi/Zi-A, WavePro 7 Zi/Zi-A, SDA/DDA 7 Zi/Zi-A, and other models that use the ProLink interface. The WL-2.92MM is for use with the 2.92mm interface of the LabMaster 10 Zi, LabMaster 9 Zi-A, and WaveMaster/SDA/DDA 8 Zi/Zi-A models.

Connecting a WL-PLINK-A to an Oscilloscope

Attach the WL-PLINK-A platform/cable assembly to the ProLink interface by aligning the connector with the input connector and pushing the interface toward the instrument.

A click is heard when the probe interface latches to the test instrument. The probe also uses thumbscrews to secure the interface to the instrument. **Do not overtighten the thumbscrews.**

Remove the platform/cable assembly from the instrument by unscrewing the thumbscrews and moving the interface up and down while pulling gently until a click is heard. This click indicates the platform/cable assembly is detached from the instrument.

Connecting a WL-2.92MM to an Oscilloscope

The WL-2.92MM Platform/Cable Assembly connection consists of a LEMO connector for power and communication and a 2.92mm signal input connector. Make corresponding connections (LEMO, 2.92mm, via included cable) to the corresponding connections on supported oscilloscopes.

Connecting a WL-2.92MM to an Oscilloscope using the LPA-2.92mm to ProLink Adapter

Some Teledyne LeCroy oscilloscopes utilize both ProLink and 2.92 mm inputs. In this case, a single WL-2.92MM Platform/Cable Assembly can be used for all types of high bandwidth inputs. Use the **LPA-2.92mm to ProLink Adapter** to connect the WL-2.92MM to a ProLink communication, power and signal interface.

Operation with a Teledyne LeCroy Oscilloscope

NOTE:

- Download the latest version of X-Stream software to run your WaveLink probe with maximum performance.
- Ensure your Windows updates are current.
- If utilizing the probe with an SDA 9000, 11000, 13000, or 18000 oscilloscope, download and install the most recent version of the Microsoft Core XML Services (MSXML) Service Pack before using your probe. Other supporting service packs may be required for MSXML to work properly.



Vertical dialog with labeled tab corresponding with your attached probe.

When the probe platform/cable assembly is connected to a probe amplifier module, and this assembly is then attached to an X-Stream oscilloscope's input, the oscilloscope recognizes the probe and activates the vertical channel functions in the user interface (shown previous). Refer to your oscilloscope's instruction manual for specific operation.

WaveLink Series Differential Probe (13-25 GHz)

The channel dialog that corresponds with the connected probe allows you to control the probe through the oscilloscope's interface:

- Touch the tab for the attached probe (varies based on the particular probe you have attached) to activate the probe dialog. The probe information frame shows the characteristics of the probe.
- Touch the **Power On** checkbox to turn the probe power on or off.
- In some applications, it may be desirable to turn the probe's AutoColor ID off or on by touching the **LED On** checkbox.



Channel trace descriptor label and Probe dialog contains data corresponding with your attached probe.

The Attributes section of the dialog includes useful information such as **Amplifier Bandwidth** and **Attenuation** of your probe signal.



Tip Select

Make the appropriate selection by touching inside the **Tip Select** control and choosing the Lead/Tip you're using.



NOTE:

- It's crucial to make the tip selection on this field as it results in the amplifier and tip combination having the response calibrated for at the factory. Failure to select the proper tip may result in inaccurate measurements.
- The number after the PT option in the Tip Select control (for example PT_50 or PT_85) indicates the resistance of the carbon composite pogo-pin tips on your particular Positioner Tip.
- The Tip Select button is made available based on the date of your probe purchase. To learn more, contact Teledyne LeCroy for support.
- Firmware version 6.2.x or greater is required when using the PT tip.

The dialog tab is labeled with the name of the corresponding tip you selected.

WaveLink Series Differential Probe (13-25 GHz)

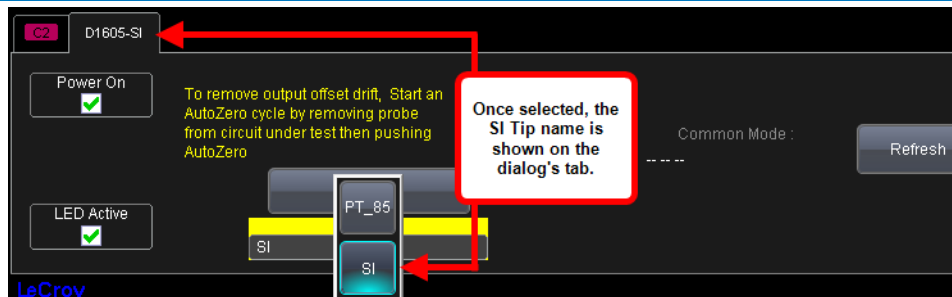

Tip selection showing the SI name on the dialog's tab.

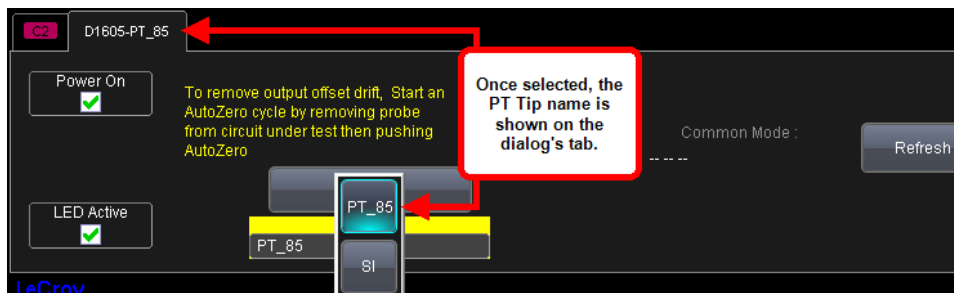

Tip selection showing the PT name on the dialog's tab.

Connecting the Probe to the Test Circuit

For all amplifier modules and interconnect leads, positive voltages applied to the + input relative to the – input deflects the oscilloscope trace towards the top of the screen.

Exercise care when connecting the probe to the test circuit to maintain the high frequency capability of the probe in measurement applications. Increasing the parasitic capacitance or inductance in the input path may introduce a ring, or slow the rise time of fast-rising signals. Any extension of the signal path with extra wire leads, etc. adversely affects the probe's performance.

A ground connection is generally not required here. Refer to **Probe Grounding** (on page 27) for more details.

Solder-in Interconnect Lead

The Solder-in Lead for the amplifier module is supplied with two pre-installed resistors, which are intended to be soldered to the runs or pad test points on the board under test. Because the resistors and the leads are small, this interconnect lead provides the maximum signal fidelity at the highest frequency response.

Follow these instructions to ensure optimal response for your SI Lead.

SI LEAD ATTACHMENT WITH PROPER STRESS RELIEF

Using a small soldering iron tip, attach the free wires of the resistors to the appropriate test points by carefully following the directions in the following sections.



CAUTION

The resistors are small in order to maintain high-frequency performance. However, they are not sturdy enough to bear the weight of the probe module. It should be supported by other means.

A positioning tool, such as the Platform/Cable Assembly Mounting Clamp, the Probe Tip Retaining Clip, or EZ Probe positioner can be used to support the probe.

NOTE: The tip clip helps secure and reinforce the SI resistive tips. Best practice is to consistently position the tip at the correct angle to the device under test which it is connected. Refer to **Proper SI Lead Positioning** for more information. The solder-in lead provides better signal fidelity performance with high frequency signals if it is elevated in this manner. The tip clip also helps to secure and reinforce the SI resistive tips, and can position the resistor leads when soldering the resistors to the test points.

SI LEAD BENDING AND SOLDERING PROCEDURE

Properly bending the SI Lead tips results in a more consistent response. Upon first receiving your SI Lead, the tips are not likely to be positioned for optimal performance when soldered to your trace.

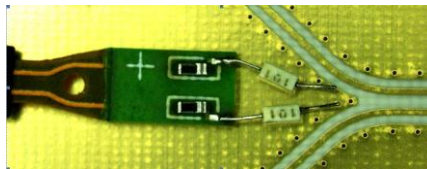

The goal is to get the resistor bodies to be parallel and the tips bent to sit on the test board traces.

1. Bend the resistor bodies to position them parallel.

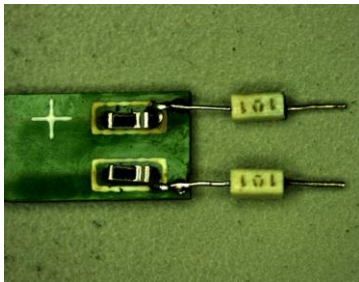

WaveLink Series Differential Probe (13-25 GHz)

2. Bend the tips in toward the center. Make the bend as close to the resistor body as possible. Bend them to about 60° from straight.

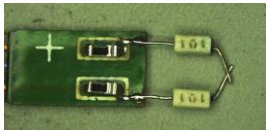

3. At this point, the leads can be bent out from their midpoints (making them parallel to each other).

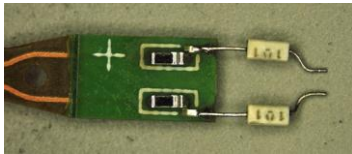

4. Perform a final check to ensure proper lead spacing and compare them to the trace spacing on the PCB.

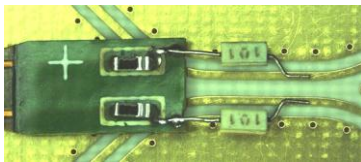

PROPER SI LEAD POSITIONING

When wires are attached to a probe's tips or leads to make probing of the circuit under test easier to perform, additional inductance and/or capacitance is added to the input, lowering the resonance frequency of a series resonance circuit, which may cause oscillations with frequencies within the passband of the probe. These effects, or excessive ringing, degrade the performance of the probe, resulting in incorrect presentation of the input signal, reduced bandwidth, and changes in loading impedance.

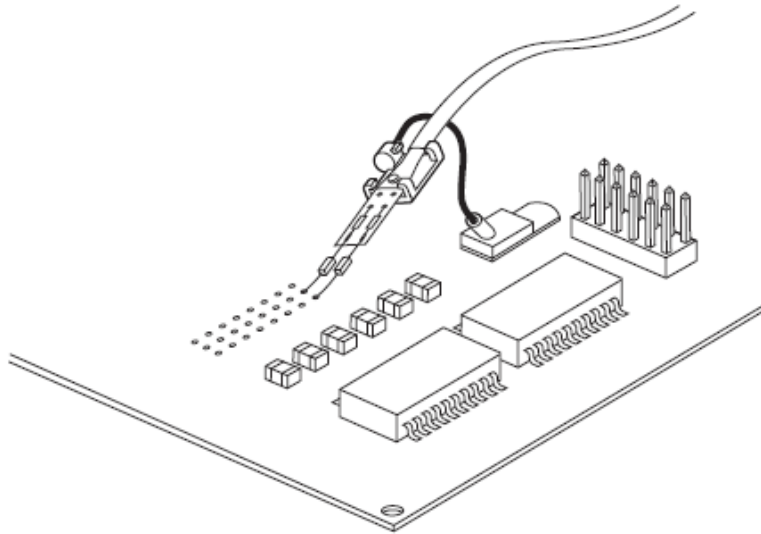

Measuring with SI Interconnect Lead

NOTE:

- The entire SI tip should be positioned with the resistor side upright facing (away from the PCB plane).
- Keep a 45 degree angle between the SI tip ends and the PCB plane.

Positioner Tip (Browser)

The Dxx05-PT Positioner Tip (Browser) has a very small form factor with very low mass. It is a good all-around browsing or mounted solution for probing in areas with a high concentration of test points or limited free space to fit a probe.

Various attachments and extenders are supplied with the Positioner Tip, allowing it to be easily held while browsing or connected to a mounting device.

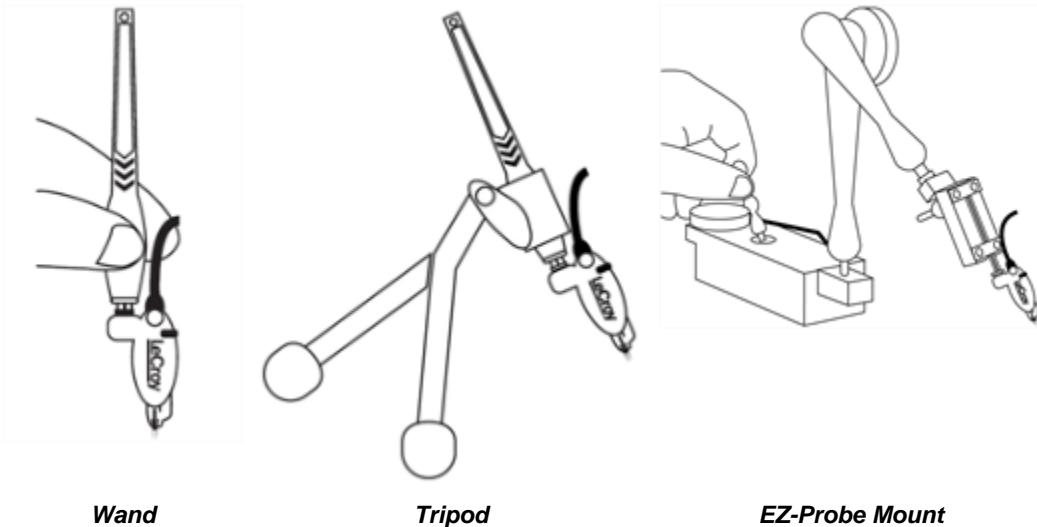

Using these attachments, the tip can be positioned in many different ways to make probing possible in tight geometries.

Rotating the thumbwheel adjusts the tip spacing from 0 to 3.5 mm (0 to 0.14") in a direction perpendicular to the thumbwheel rotation. There is a positive stop on the thumbwheel to prevent it from being rotated too far in either direction.

The tip is a pogo-pin assembly and is spring-mounted to accommodate 0.55mm of Z-Axis compliance. This aids in applications where more than one Dxx05-PT tip is required to make measurements in a crowded area and the tips need to be mounted at an angle to the board under test.

Avoid applying excessive lateral pressure on the tip as breakage may result. Do not use the tip to scrape the circuit. If the tip does break, it may be replaced in the socket. If the socket also breaks, a

new socket can be soldered onto the tip. See **Replacing Spring-Loaded Tips and Tip Sockets on the Positioner Tip** (on page 1) for instructions on replacing tips and sockets.

Probe Grounding

In most cases, when the common mode portion of the signal consists mainly of lower frequencies, the probe does not need to be connected to the ground of the circuit under test. This minimizes the effects of ground loop currents. Any signal corruption caused by not having the probe connected to ground of the signal under test is common to both inputs and is rejected by the differential operation of the probe.

However, in an environment with high RF ambient noise, it may be better to connect the probe ground lead to a good RF ground near the point where the signal is being measured. Find out if a ground lead is necessary by making a measurement with and without a ground lead. Use the one that provides the least signal corruption.

Capacitive coupling from AC mains may cause truly floating devices (like battery operated devices) to exceed the common mode range. In such cases it is recommended to connect the probe ground to the device under test.



- Circuits powered from laboratory bench power supplies normally have floating outputs.
- Floating circuitry may exceed the common mode input voltage, causing damage to the probe. Always use a ground lead when testing floating circuits.

Positioning of the Input Leads

Normally the performance of the Solder In Lead and Positioner Tip Browser is not affected by the position of the amplifier module. They can be mounted straight upright or on an angle. However, when it is necessary to mount the module parallel to the board, the maximum performance is obtained when the + sign (printed near the positive input on both the SI Lead and the PT Tip) is upward facing.

NOTE: The flexible cable connecting the input tip to the amplifier module is reasonably insensitive to placement, but can be affected by large signal emitters on the device under test, so avoid placing it near these types of signals

AutoColor ID and Power Control Indicators

The AutoColor ID LED, built into the platform/cable assembly, indicates various states of the probe-oscilloscope combination:

AutoColor ID

When the probe is connected to a Teledyne LeCroy X-Stream oscilloscope, the LED illuminates in the default color of the channel to which the probe is connected.

Platform/Cable Assembly Compatibility

When the probe tip module is compatible with the platform/cable assembly to which it is connected, the green LED illuminates for about one second after the probe is connected to the oscilloscope.

Conversely, when the probe tip module is incompatible with the platform/cable assembly, the red LED illuminates—for example, when a Dxx05 amplifier is connected to a WL-PLINK instead of a WL-PLINK-A.

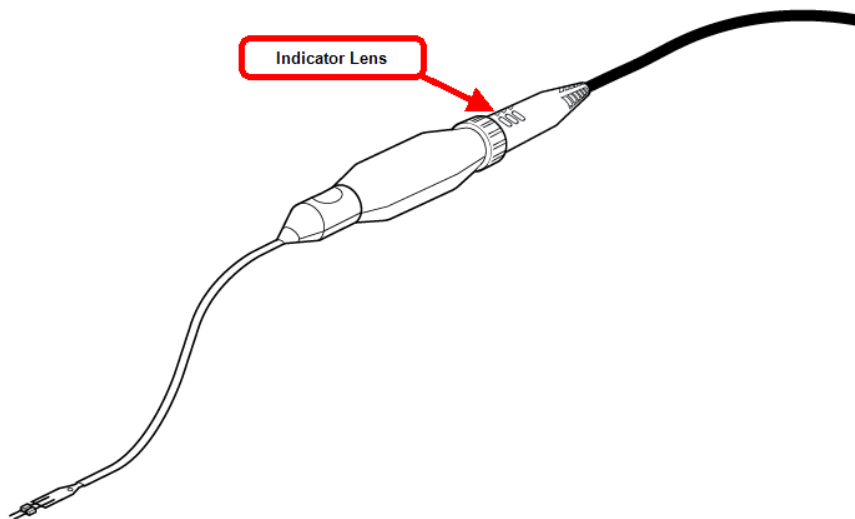

AutoZero

WaveLink probes incorporate an AutoZero function to remove any DC offset from the probe. This function is available when the probe is used with Teledyne LeCroy's X-Stream oscilloscopes, and must be invoked by the user.

After several minutes of warm-up, or when the probe is exposed to a large shift in ambient temperature, some DC offset may occur, and an AutoZero cycle should be initiated.

Start an AutoZero cycle by removing the probe from the circuit under test and touching the on-screen **AutoZero** button to remove output offset drift.

Accessory Use

A variety of accessories are provided with the probe and platform/cable assembly. These accessories help keep the probe tip in place and provide deskew capabilities or are simply common replacement parts.

Positioning Tools

Freehand Probe Holder

The FreeHand Probe Holder (PACC-MS001) is provided as a standard accessory with the WL-PLINK-A-CASE and WL-2.92MM-CASE. It is designed to keep most of the weight on the probe tip preventing loss of contact with the circuit under test. The FreeHand Probe Holder is a stable, quick and easy-to-set-up probe positioner, improving your ability to concentrate on the measurement by not having to hold the probe.

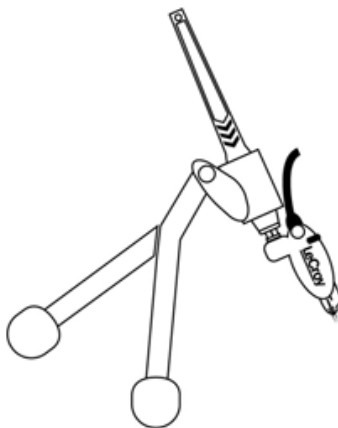

WaveLink Series Differential Probe (13-25 GHz)

EZ Probe Positioner

The EZ Probe Positioner is available as an optional accessory. It provides stable, accurate positioning in the X-Y-Z Axes.

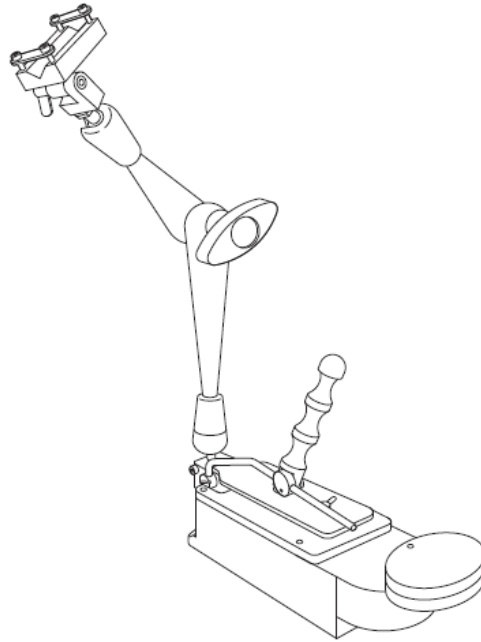

The unique 3:1 motion reduction joystick allows simple, precise positioning of the attached probe in both the horizontal and vertical measuring plane. The probe has a fully-articulating arm, providing 30 cm (12 inch) reach in virtually any direction.

The XYZ joystick has separate friction controls allowing independent X-Y plane or Z-Axis movement and is especially useful when combined with the Positioner Browser Probe Tip.

The EZ-Probe Positioner comes with a vacuum mounted base to keep the probe in place in any test environment. However, the solid base is heavy enough that the positioner can be used without the vacuum.

Long Interconnect Extender

The Long Interconnect Extender (provided with Dxx05-PT-KIT) is used to connect the probe to the EZ-Microtech Positioner Arm. Attach the probe by first removing the screws holding the top plate to the V-shaped probe holder. Rest the long interconnect extender in the V-shaped groove, and fasten the top plate to the holder, using the removed screws (as follows). Then, insert the Dxx05-PT onto the long interconnect extender.

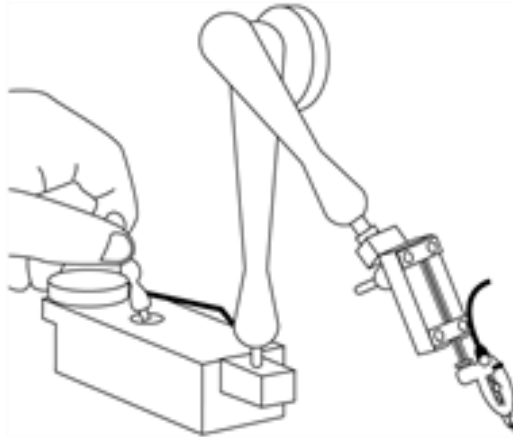

Positioner Tip mounted to EZ Probe Positioner and Long Interconnect Extender

NOTE:

- Do not overtighten the screws.
- There is no fine adjust on the EZ probe. It is easy to exceed the Z-Axis compliance rating of the PT. Use care when positioning the PT with the EZ probe.

Once the probe has been attached, loosen the knob on the EZ positioner arm and position the probe close to the test point. Tighten the knob and use the joystick to fine position the probe.

Dxx0-PT-XYZ-Positioner

This positioner is a small, lightweight device that can be affixed to the printed circuit assembly using the included adhesive pads. The black adhesive pads are for more permanent attachment, whereas the white adhesive pads leave less residue when removed. The wide variety of short, long, swivel, and right angle interconnect parts can be connected to the top assembly, which can then be moved up and down along the Z-Axis to increase or release pressure on the probe points. The bottom assembly contains a tightening wheel which can be loosened to allow minor X-Y Axis adjustments, and then tightened to fix the exact probing position.

WaveLink Series Differential Probe (13-25 GHz)

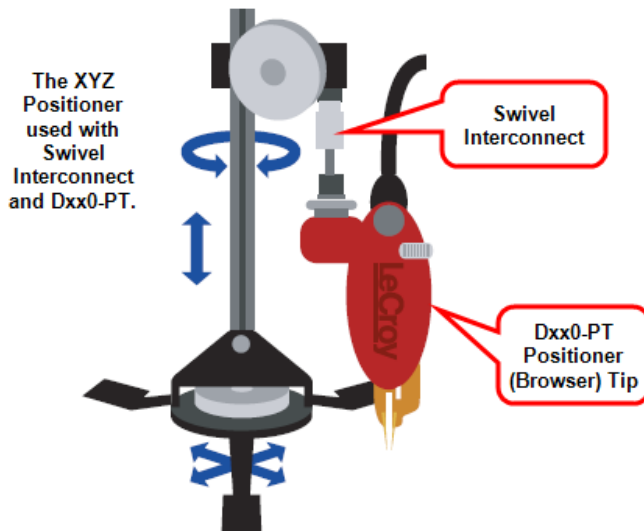

The Positioner (Browser) Tip mounted to XYZ Positioner with Swivel Interconnect

Tip Retaining Clip

The Tip Retaining Clip (PK600ST-3) helps hold the SI Interconnect Leads in place while making measurements or when soldering the damping resistors to the test points of the board under test.

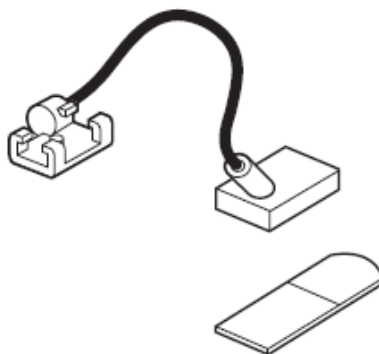

The Clip comes standard with the **Differential Amplifier Small Tip Modules** (on page 7), along with a set of 10 white and 10 black Adhesive Pads (Dxx0-PT-TAPE) used for mounting the clip to the board.

FASTENING THE CLIP TO THE BOARD

Fasten the clip to the board by removing the small piece of protection paper from one side of the adhesive pad and mount the pad to the underside of the clip. If necessary, use alcohol to clean the section of the board where the clip is mounted to remove any grease or flux residue.

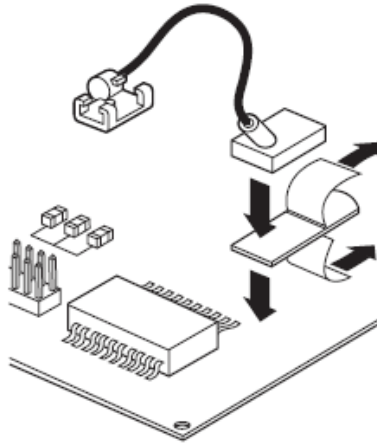

Connecting the SI Module Using the Tip Retaining Clip

Remove the protective paper from the other side of the adhesive pad and mount the clip to the desired location on the board. Apply pressure to the clip for at least several seconds to assure proper adhesion (shown previous)

The adhesive pad with the tab is still visible and stays attached to the adhesive pad. The tab is used to remove the clip from the board.

NOTE: Maximum strength of the adhesive pad is obtained after about 30 minutes.

MOVING AND POSITIONING

Always apply pressure to the pad (as follows) to prevent any shifting while bending the arms and/or moving the probe adapter portion of the clip (typically done while positioning or attaching the probe).

NOTE: This is especially important if moving and positioning before the adhesive pads have properly cured.

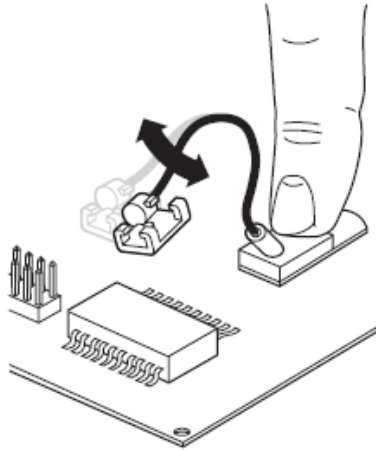

Applying pressure when adjusting the probe holder

ATTACHING THE PROBE

Attach the probe by positioning the cable of the module on top of the clip and sliding the input board of the module into the grooves. While moving the probe into position for measurement, apply pressure to the mounting pad to prevent the adhesive pad from moving and losing its adhesion.

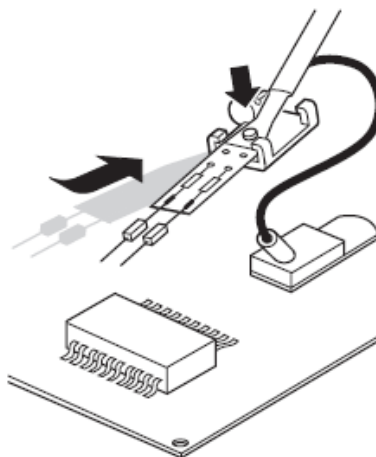

Attaching the Probe

REMOVING THE TIP RETAINING CLIP

Remove the retaining clip from the board by pulling on the tab of the adhesive pad. The clip can now be removed easily without leaving any adhesive residue and can be used in another application using a new adhesive pad.

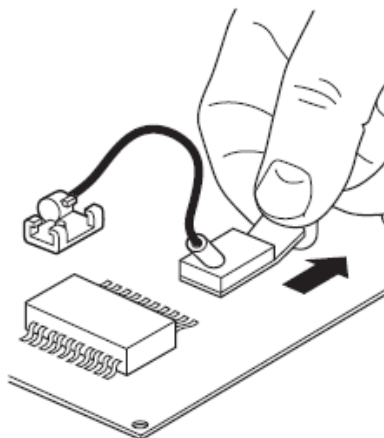

Removing the retaining clip

Platform/Cable Assembly Mounting Kit

Platform/Cable Assembly Mounting Kit (PK600ST-4) can be used to support to the platform/cable assembly and relieve stress on interconnect leads when the test points are located close to the edge of the board under test.

The PK600ST-4 includes one board edge clip and four adhesive backed platform/cable assembly clamps.

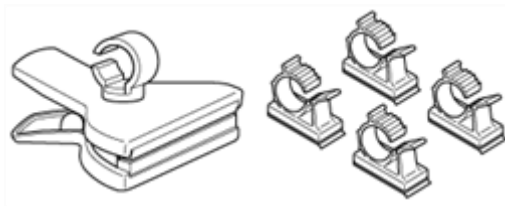

WaveLink Series Differential Probe (13-25 GHz)

PLATFORM/CABLE ASSEMBLY BOARD EDGE CLIP

The Platform/Cable Assembly Location Clip can be used to give support to the probe and Interconnect Lead when the test points are located close to the edge of the board under test. It's also useful for holding the probe assembly while soldering the solder-in interconnect lead to your device under test.

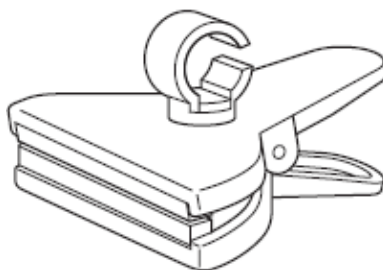

Slide the probe cable into the clamp opening and move the probe so that the probe's strain relief is located in the opening. Close the clamp.

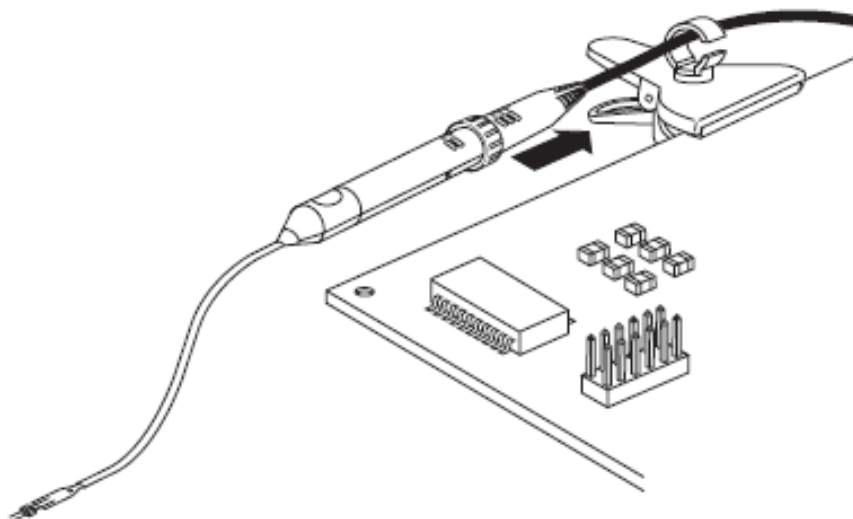

Slide the probe into the board edge clip

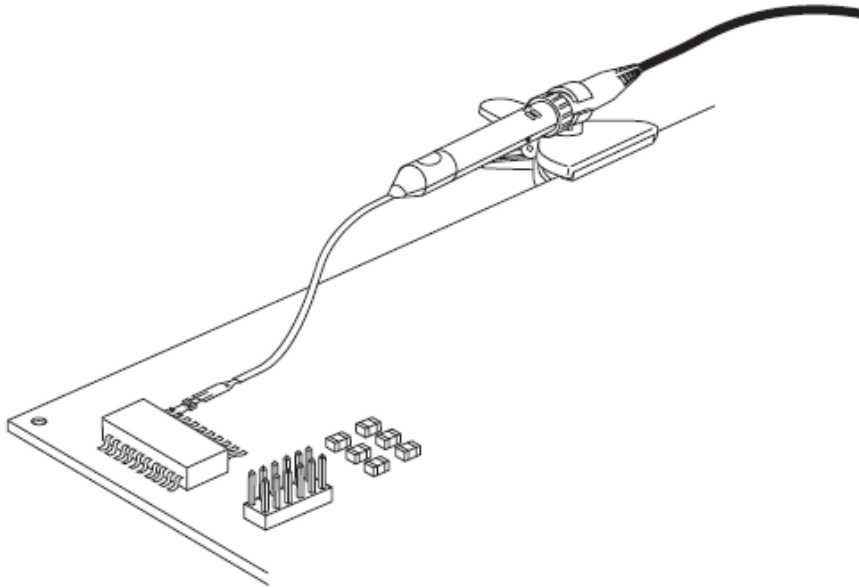

Insert the probe body into the board edge clip and position the clamp as desired.

ADHESIVE BACKED PLATFORM/CABLE ASSEMBLY CLAMPS (4)

The Adhesive Backed Probe Body Clamp provides additional support to the Platform/Cable Assembly and Interconnect Lead anywhere on the board under test.

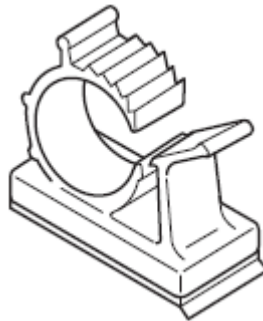

Connection Guides

Probe connection guides are designed to make it easy to electrically isolate the two probe tips when browsing. They also greatly reduce accidental and unwanted contact across probe points.

Before attaching connection guides, clean the PCA assembly area with IPA or another cleaner to remove oils. Then, apply with a light pressure, release, and let set for one hour.

Probe Deskew Fixtures

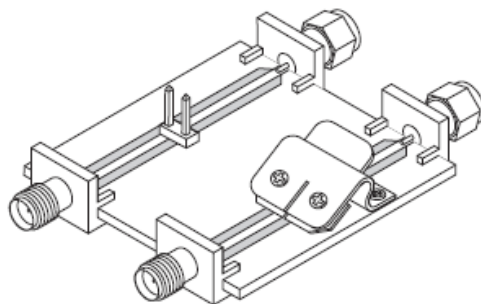

The Probe Deskew Fixture (PCF200) is provided as a standard accessory with WaveLink series Platform/Cable Assemblies.

For WaveLink probes designed to accommodate all WaveLink tips (not at full bandwidth), the fixture may be used as a convenient way to deskew several probes/oscilloscope channels. This can be accomplished in the following ways:

- Connect a fast edge to one or both inputs. Connect the probe tip(s) to the appropriate connection point. Solder-in probe tips and browser tips may be inserted under the clamping mechanism. Display the probe signals on the oscilloscope screen and use the channel deskew adjust to align them to a common point.
- Connect the WavePro/SDA/DDA 7 Zi/Zi-A, WaveMaster/SDA/DDA 8 Zi/Zi-A, or LabMaster 9 Zi-A fast edge output to one of the inputs. Set the oscilloscope to trigger on the internal Fast Edge source. Set the trigger delay to zero. Now, on the vertical dialog, use the Probe Cal - Cable Deskew button to align one signal/channel at a time to the specified zero delay trigger point (center of screen). Repeat for as many probes as you have connected, each time aligning them to the common point.

NOTE: The Probe Deskew fixture has an inherent rise time limitation of ~70ps. Deskew of very high frequency signals using WaveLink High Bandwidth Differential Probes may require a faster rise time than this fixture can provide. In this case, utilize one of your signals as a reference point, and then deskew all additional signals to the reference signal.

TF-DSQ Fixture Accessory

A TF-DSQ fixture is available as a Teledyne LeCroy accessory. The product is used in conjunction with the oscilloscope software to perform probe deskew and DC calibration. A manual explaining the operation of the TF-DSQ is available for download from teledynelecroy.com.

Care and Maintenance

Cleaning

The exterior of the probe and cable should be cleaned, using a soft cloth moistened with water. The use of abrasive agents, strong detergents, or other solvents may damage the exterior of the probe.



The probe case is not sealed and should never be immersed in any fluid.

Replacing Damping Resistors on the Solder-in Interconnect Lead

The external damping resistors locate the tip resistance as close to the device under test as possible, which minimizes tip inductance and capacitance and provides very favorable loading characteristics.

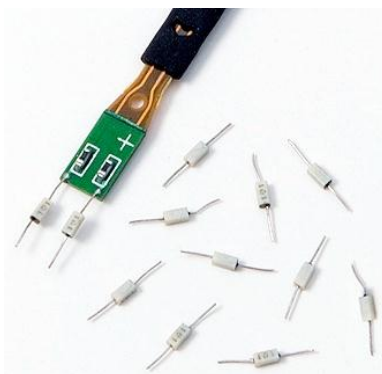

However, these resistors are subject to mechanical stress and may periodically need to be replaced even if proper stress-relief precautions are taken. Replacement damping resistors are included with the probe, and replacement of these resistors is simple. Resistors are pre-cut to the right lead lengths, so all that is required is removal and attachment of the new resistor.

Follow these steps to correctly remove the damaged damping resistors and to solder a new resistor to your tip. It is assumed that the person performing the resistor replacement is familiar with fine pitch soldering techniques.

WaveLink Series Differential Probe (13-25 GHz)

1. Remove the old resistor tip and any remaining solder from the long solder pad using a fine tip soldering iron taking care not to de-solder the SMT resistors.

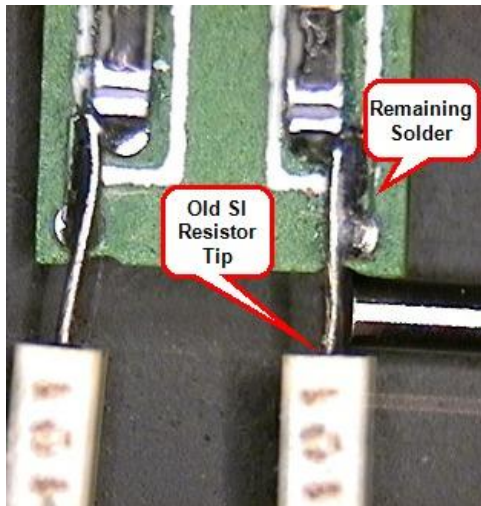

2. Use a soldering iron to pre-tin the pad. Wash the area with isopropyl alcohol to remove any residual flux.
3. Align the damping resistor lead with the end of the tin pad and solder in place running the lead along the pad and over the via. Avoid using excessive amounts of solder. Use the photographs in this topic as a reference for the proper amount of solder.
4. Verify the following dimensions for:
 - **Resistor Lead Length**
 $0.090 +0.000 / -0.010$ (inches)
 $2.286 +0.000 / -0.254$ (millimeters)

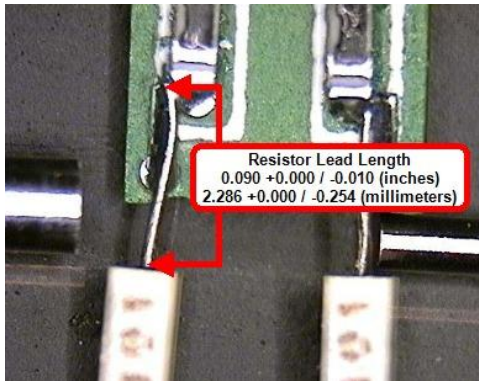

- **Resistor Gap to PCB Edge**

0.050 - 0.025 (inches)

1.27 - 0.635 (millimeters)

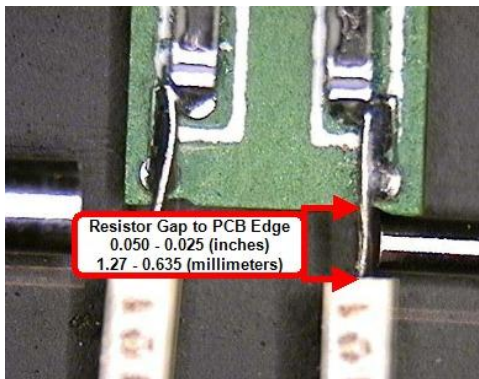

Correctly Replacing Carbon Composite Resistive Pogo-Pin Tips in Dxx05-PT

Keep the following in mind regarding Pogo Pin tips replacement, care, and use:

- The Pogo-Pin Tip pair must have a matched resistive value. If one breaks, and the replacement has a different resistive value (likely if they are from different lots), then the pair must be replaced . See **Setting Matched Replacement Pogo-Pin Tip Ω Values Using the Dxx05-PT Pogo-Pin Replacement Software Utility** section for details.
- Don't remove your Pogo Pin tips from the socket for non-use or storage. Only remove them when replacement is necessary.
- Never use probe tips as scraping tools.
- New carbon fiber tip technology enables low-loading, high-bandwidth measurements. Do not over compress.
- When applying probe to test points only use light pressure. Take care not to apply pressure exceeding throw of precision pogos.

Occasionally check the overall resistance of the center conductor on the small solder mount push-on (SSMP) to the tip itself. The side to side resistance should be within 30 Ω of each other.



Removing Old Pogo Pin Tip

Remove Pogo Pin tip by grasping the narrow collar and pulling in a straight, outward motion.

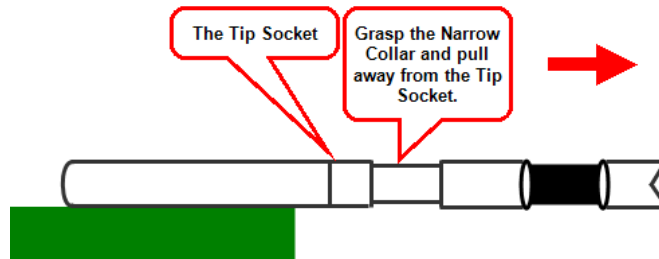

Inserting New Pogo Pin Tip

Hold the replacement Pogo Pin tip by the collar and push directly into socket. You'll hear the tip snap into place.

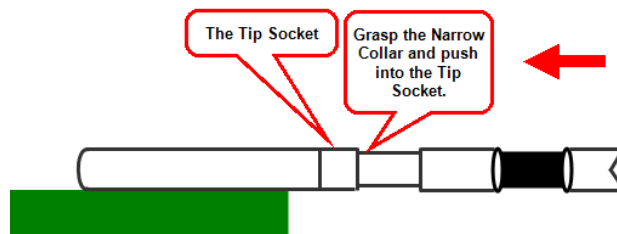

Setting Matched Replacement Pogo-Pin Tip Ω Values Using the Dxx05-PT Pogo-Pin Replacement USB Stick Software Utility

The carbon-composite pogo-pin tips in the Dxx05-PT Positioner Tip browser are a resistively matched set. Proper performance of this tip requires the resistive values of the pogo-pins are of a known, matched value.

At original shipment of a Dxx05-PT Positioner Tip browser, two carbon-composite pogo-pins are pre-installed in the positioner tip and two additional spare pogo-pins are also provided. These spare pogo-pins are resistively matched with the pre-installed pogo-pins, so if these specific spares are

WaveLink Series Differential Probe (13-25 GHz)

used to replace a broken pogo-pin, no additional activity is necessary (other than mechanical replacement).

However, if spare pogo-pin tips are separately ordered, their resistive values are possibly unmatched to the originals. Therefore, Teledyne LeCroy supplies a USB memory stick containing a Dxx05-PT Pogo-Pin Replacement software utility along with the spare pogo-pins.

So, when the spare tips originally supplied with the Dxx05-PT are consumed, pogo-pins should only be mechanically replaced with pogo-pin tips having matched values, and the Dxx05-PT Pogo-Pin Replacement software utility must be run after replacement.

NOTE:

- Tips from different lots or vials (a vial, Dxx05-PT-TIPS, is included with your Dxx05-PT) should not be intermixed with tips from other lots or vials.
- The Dxx05-PT Pogo-Pin Replacement Software Utility is provided on a USB Stick with a newly-purchased Dxx05-PT Positioner Tip Browser. The utility is also available for download at teledynelecroy.com.

Connect your USB Stick to your instrument and view the contents. Copy the Utility Program to the desktop of your oscilloscope, and then double-click/run the program.

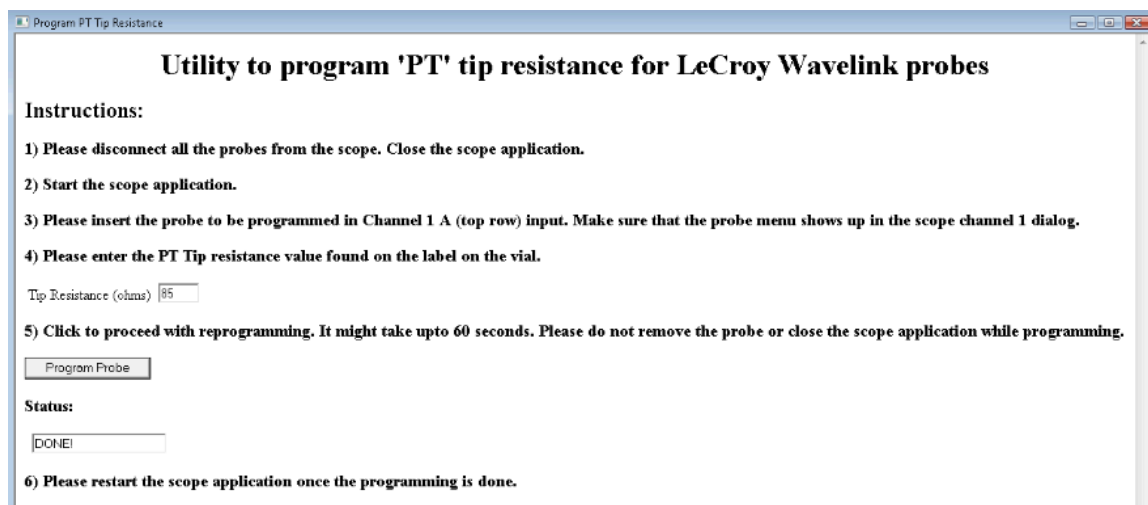

The Utility Program screen is then shown. Use the steps shown on the screen as follows to set your Pogo-Pin Tip Ω values correctly:

1. Disconnect your Dxx05-PT Positioner Tip Browser (and any other probes) from your oscilloscope and Exit the oscilloscope application using **File** → **Exit** from the menu bar. The desktop of your oscilloscope should be showing with the instrument still running.
2. Now, start the oscilloscope application by touching the desktop shortcut.
3. Connect the Platform/Cable Assembly of your Positioner Tip Browser to the upper-row Channel 1 oscilloscope input using the LPA-2.92 mm to ProLink Probe Adapter.

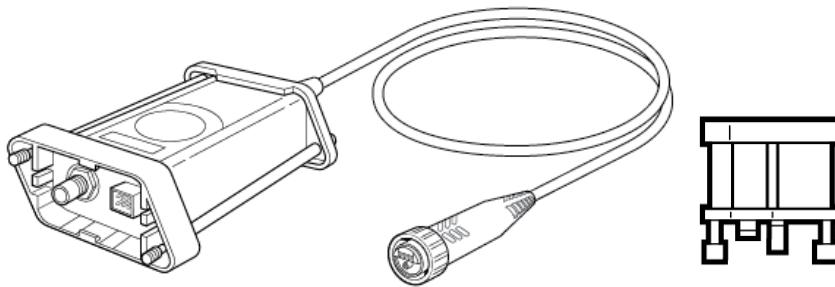

Confirm your Probe dialog is shown as part of the Channel 1 dialog.

4. Provide the PT Tip Resistance value. The label on the vial containing your replacement pins shows this resistance value.

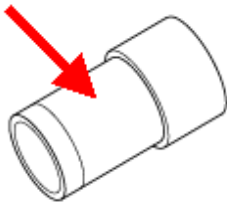

5. Click the Program Probe button to proceed with your tip reprogramming. When the **Status** message shows **DONE!**, the reprogramming procedure has finished.

WaveLink Series Differential Probe (13-25 GHz)

NOTE:

- The reprogramming procedure should take about 60 seconds.
 - Do not remove the probe or close the oscilloscope application during the reprogramming procedure.
6. Finally, restart the oscilloscope application using steps 1 and 2 of this procedure.

Service Strategy

Defective probes or probe tip modules must be returned to a Teledyne LeCroy service facility for diagnosis and repair or replacement. Defective products under warranty are repaired or replaced.

See **Service Options** (on page 1) for more details.

Returning a Product for Calibration or Service

Return a product for calibration or service by contacting your local Teledyne LeCroy sales representative. They tell you where to return the product. All returned products should be identified by both **model** and **serial number**. Provide your **name**, a **contact number**, and a **description of the defect or failure** (if possible).

Products returned to the factory require a **Return Material Authorization (RMA)** acquired by contacting your nearest Teledyne LeCroy sales office, representative, or the North America Customer Care Center.

- Return shipments should be prepaid.
- Teledyne LeCroy cannot accept COD or Collect Return shipments.
- We recommend air-freighting.

NOTE: It is important that the RMA be clearly shown on the outside of the shipping package for prompt redirection to the appropriate department.

Follow these steps for a smooth product return.

1. Contact your local Teledyne LeCroy sales or service representative to obtain a Return Authorization Number.
2. Remove all accessories from the device. Do not include the manual. If you need to return a Dxx05 module, be sure to include SI Interconnect Leads and Tips.
3. Pack the probe in its case, surrounded by the original packing material (or equivalent) and box.
4. Label the case with a tag containing:
 - The RMA
 - Name and address of the owner
 - Product model and serial number
 - Description of failure
5. Package the probe case in a cardboard shipping box with adequate padding to avoid damage in transit.
6. Mark the outside of the box with the shipping address given to you by the Teledyne LeCroy representative; be sure to add the following:
 - ATTN: <RMA assigned by the Teledyne LeCroy representative>
 - FRAGILE
7. Insure the item you're returning (for at least the replacement cost).
8. Ship the package to the appropriate address.



Returning a Product to a Different Country



NOTE: Be sure to properly mark shipments returned for service from a different country to avoid customs duty for a full purchase price of a new probe or accessory.

In addition to the items mentioned in the previous topic, mark shipments returned for service as a **Return of US manufactured goods for warranty repair/recalibration**. If there is a cost involved in the service, put the cost of the service in the value column and the original value of the product at time of purchase in the body of the invoice marked **For insurance purposes only**.

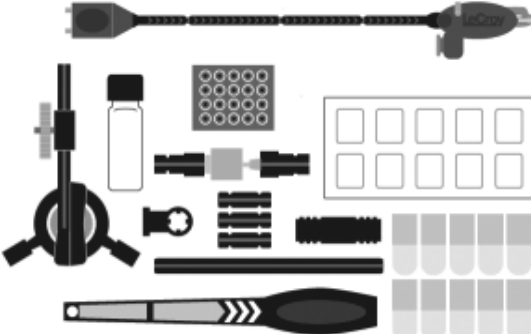

Be very specific as to the reason for shipment. Duties may have to be paid on the value of the service.

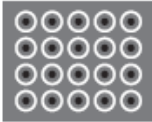
Consumables and Replacement Parts

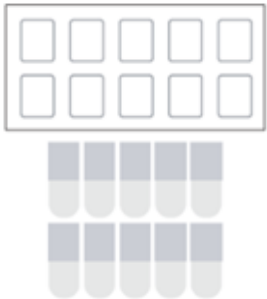
Description and Initial Product Code	Image	Replacement Product Code
<p>Positioner Tip with Accessories Dxx05-PT-Kit</p>		<p>RK-Dxx05-PT-Kit</p>
<p>Positioner Tip (Only ordered as a replacement.)</p>		<p>Dxx05-PT</p>

Description and Initial Product Code	Image	Replacement Product Code
<p>Pogo Pin Tips (for PT Tip) (Only ordered as a replacement.)</p>		<p>Dxx05-PT-Tips (Included as part of Dxx05-PT-Kit) (Qty. 4)</p>
<p>Pogo Tip Connection Guides (Only ordered as a replacement.)</p>		<p>Dxx05-PT-Guides (Included as part of Dxx05-PT-Kit)</p>
<p>XYZ Positioner (Only ordered as a replacement.)</p>		<p>Dxx0-PT-XYZ-Positioner (Included as part of Dxx05-PT-Kit)</p>
<p>Adhesive Tape for XYZ Positioner (Only ordered as a replacement.)</p>		<p>Dxx0-PT-Tape (Included as part of Dxx05-PT-Kit) (10 Pcs. each)</p>

WaveLink Series Differential Probe (13-25 GHz)

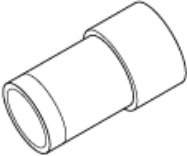
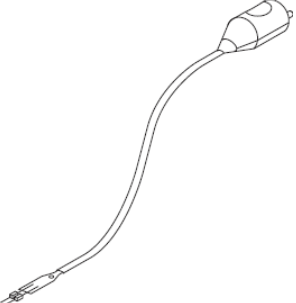
Description and Initial Product Code	Image	Replacement Product Code
<p>Browser Wand for PT Tip (Only ordered as a replacement.)</p>		<p>Dxx0-PT-Wand (Included as part of Dxx05-PT-Kit) (Qty. 1)</p>
<p>Interlock Pieces for PT Tip (Only ordered as a replacement.)</p>		<p>Dxx0-PT-Interlock (Included as part of Dxx05-PT-Kit) (6 Pcs.)</p>
<p>Swivel for PT Tip (Only ordered as a replacement.)</p>		<p>Dxx0-PT-Swivel (Included as part of Dxx05-PT-Kit) (Qty. 1)</p>
<p>Solder-in Tips (Only ordered as a replacement.)</p>		<p>Dxx05-SI-RESISTORS (Included as part of Dxx05) (Qty. 10)</p>
<p>Solder-in Lead (Only ordered as a replacement. Also, includes PK600ST-3.)</p>		<p>Dxx05-SI (Included as part of Dxx05)</p>

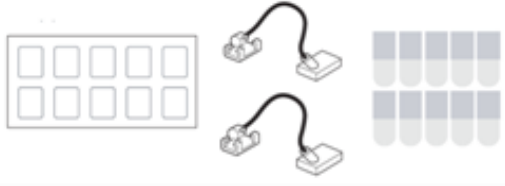
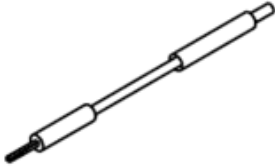
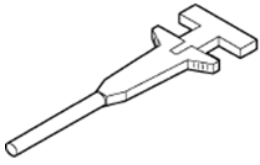
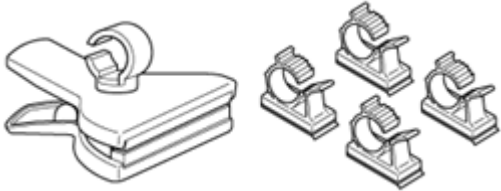
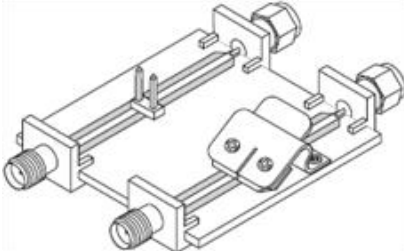
Description and Initial Product Code	Image	Replacement Product Code
<p>Replacement Solder-in Probe Holder Kit</p> <p>(Only ordered as a replacement. Includes 2 tip retaining clips and 1 set of adhesive tape.)</p>		<p>PK600ST-3</p> <p>(Included as part of Dxx05, Dxx30, D6x0/D4x0.)</p>
<p>Ground Lead</p> <p>(Only ordered as a replacement. Includes 4 leads.)</p>		<p>PACC-LD005</p> <p>(Included as part of Dxx05, Dxx30, D6x0/D4x0.)</p>
<p>Ground Clip</p> <p>(Only ordered as a replacement. Includes 2 clips.)</p>		<p>PK006-4</p> <p>(Included as part of Dxx05, Dxx30, D6x0/D4x0.)</p>
<p>Platform/Cable Assembly Mounting Kit</p> <p>(Only ordered as a replacement.)</p>		<p>PK600ST-4</p> <p>(Included as part of WL-PLINK-Case, WL-PLINK-A, WL-PBus, and WL-2.92MM-CASE.)</p>
<p>Probe Deskew Fixture</p> <p>(Only ordered as a replacement.)</p>		<p>PCF200</p> <p>(Included as part of WL-PLINK, WL-PLINK-A, WL-PBus, and WL-2.92MM-CASE.)</p>

WaveLink Series Differential Probe (13-25 GHz)

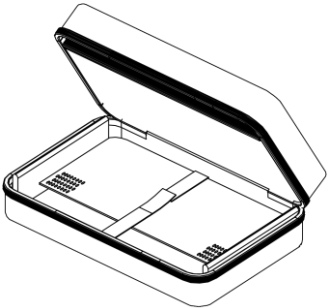
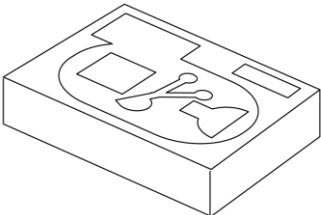
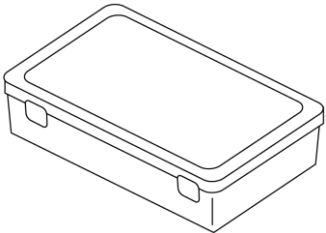
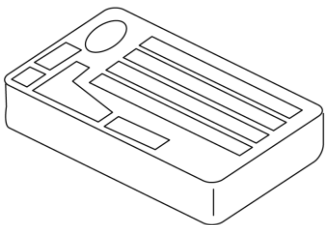
Description and Initial Product Code	Image	Replacement Product Code
Deluxe Soft Carrying Case (Only ordered as a replacement)		SAC-03 (Included as part of WL-PLINK-A-CASE, WL2.92MM-CASE, Dxx05-PS)
Foam Insert for SAC-03		921080-00 for WL-2.92MM-CASE; 921081-00 for WL-PLINK-A-CASE
Protective Storage Case (Only ordered as a replacement)		921083-00 (Included as part of WL-PLINK-A-CASE, WL-2.92MM-CASE, Dxx05-PS)
Plastic Tray for Protective Storage Case (Only ordered as a replacement)		921078-00 (Included as part of WL-PLINK-A-CASE, WL-2.92MM-CASE, Dxx05-PS)

To learn more about these available replacement parts, contact Teledyne LeCroy for support.

NOTE: For warranted accuracy, amplifiers must be returned to factory for calibration with leads.

Service Options

The following Service Options are available for your Teledyne LeCroy probe product:

Service Option	Product Code
Three-Year Warranty for D1305-A	D1305-A-W3
Three-Year Warranty for D1605-A	D1605-A-W3
Three-Year Warranty for D2005-A	D2005-A-W3
Three-Year Warranty for D2505-A	D2505-A-W3
Three-Year Warranty for WL-PLINK-A-CASE	WL-PLINK-A-CASE-W3
Three-Year Warranty for WL-2.92MM-CASE	WL-2.92MM-CASE-W3
Three-Year Warranty for Dxx05-PT	Dxx05-PT-W3
Five-Year Warranty for D1305-A	D1305-A-W5
Five-Year Warranty for D1605-A	D1605-A-W5
Five-Year Warranty for D2005-A	D2005-A-W5
Five-Year Warranty for D2505-A	D2505-A-W5
Three-Year Warranty for WL-PLINK-A-CASE	WL-PLINK-A-CASE-W5
Three-Year Warranty for WL-2.92MM-CASE	WL-2.92MM-CASE-W5
Three-Year Warranty for Dxx05-PT	Dxx05-PT-W5
Three-Year Warranty and Annual NIST Calibration	D1305-A-T3
Three-Year Warranty and Annual NIST Calibration	D1605-A-T3
Three-Year Warranty and Annual NIST Calibration	D2005-A-T3
Three-Year Warranty and Annual NIST Calibration	D2505-A-T3
Five-Year Warranty and Annual NIST Calibration	D1305-A-T5
Five-Year Warranty and Annual NIST Calibration	D1605-A-T5
Five-Year Warranty and Annual NIST Calibration	D2005-A-T5
Five-Year Warranty and Annual NIST Calibration	D2505-A-T5
Five-Year Annual NIST Calibration	D1305-A-C5
Five-Year Annual NIST Calibration	D1605-A-C5
Five-Year Annual NIST Calibration	D2005-A-C5
Five-Year Annual NIST Calibration	D2505-A-C5

WaveLink Series Differential Probe (13-25 GHz)

Service Option	Product Code
NIST Traceable Calibration with Test Data* (one module)	D1305-A-CCNIST
	D1605-A-CCNIST
	D2005-A-CCNIST
	D2505-A-CCNIST

*CCNIST NIST traceable calibration with test data is an available option for D1305-A, D1605-A, D2005-A, and D2505-A probe tip modules only when ordered with either a WL-PLINK-A-CASE or WL-2.92MM-CASE platform/cable assembly.

To learn more about these available service options, **Contact Teledyne LeCroy for Support.**

Functional Test

Functional Test Overview

The functional test can be used to verify the basic operation of the WaveLink Differential Probe functions, using a Teledyne LeCroy X-Stream oscilloscope. Refer to the oscilloscope's online help for proper use of the touch screen and controls.

Test Setup

Use the following steps to set up the basic tests:

1. Connect an amplifier module to a platform/cable assembly (for example, a D1605-A to a WL-PLINK-A), and then connect an interconnect lead to the amplifier module. Then connect the platform/cable assembly to channel 1 of the oscilloscope. The instant the probe is connected to the oscilloscope, the AutoColor ID LEDs should illuminate GREEN for less than 1 second indicating the probe is compatible with the oscilloscope.
2. After the green LED indication, the Probe AutoColor ID indicators illuminate in the color of the channel to which the probe is connected. Verify the probe AutoColor ID indicates the proper corresponding channel color by disconnecting the probe and reconnecting to the other channels. Reconnect the probe to Channel 1.

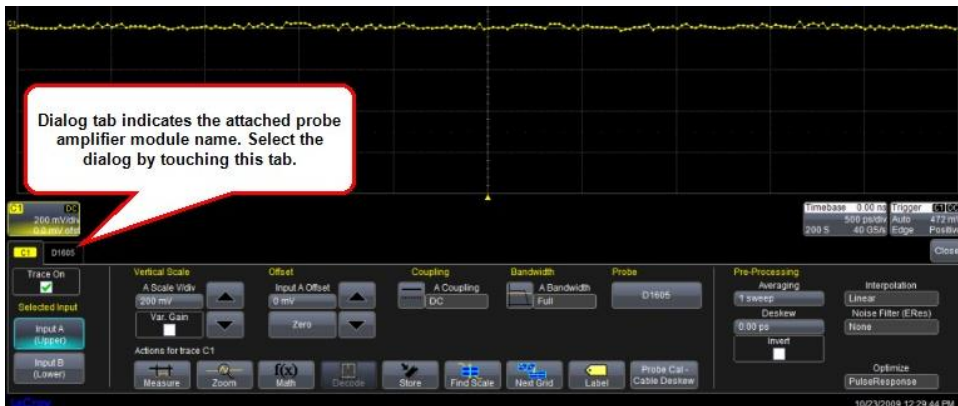

Vertical dialog with labeled tab corresponding with your attached probe.

3. Turn on the channel corresponding to the connected probe.
4. Touch the probe-connected channel's trace label. The **Cx Vertical Adjust** dialog is shown. Verify the probe model. The **D1605**, is shown (previous).
5. Touch the D1605 indicator tab to show the D1605-A probe dialog as follows:

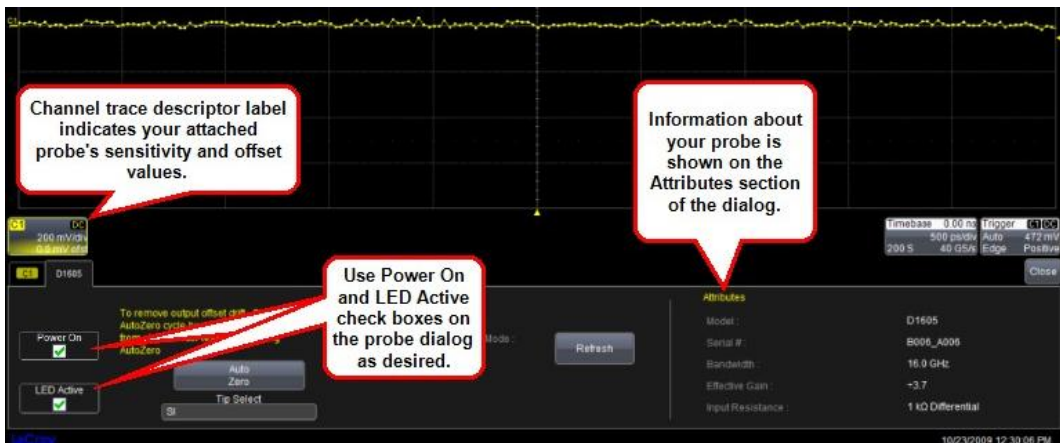

Channel trace descriptor label and Probe dialog contains data corresponding with your attached probe.

6. Touch the **Power On** checkbox to verify the AutoColor ID LEDs on the probe is OFF (and probe power is OFF). Turn the power back ON by clicking the checkbox again.
7. Touch the **LED On** checkbox to verify the probe's AutoColor ID LEDs turn off (probe power is still ON). Turn LEDs back ON.

WaveLink Series Differential Probe (13-25 GHz)

- At this point, the Calibrator must be set up before performing the functional tests. Select **Utilities** → **Utilities Setup...** from the menu bar.
- Touch the **Aux Output** tab as follows:
- Touch the **Square** button to obtain a square wave output signal.



Auxiliary output setup

NOTE: TTL is processed internally (and the Aux Output dialog shows a TTL checkbox) for the following oscilloscope models: WaveMaster 5000, 6000, SDA 4000, 5000, and 6000.

- Set the amplitude to 1 Volt, Frequency to 1.00 kHz.
- Verify the screen indicates the proper settings in the Aux Output fields.
- Set the probe sensitivity to 200 mV/div.

Connect the + tip of the interconnect lead module to the center connector of the calibrator output signal, and the – lead to the shell (ground) of the connector. If necessary, readjust the tip spacing.

- Verify the screen shows a square wave (you may need to adjust the channel offset). Refer to the following screen-shot. If no square wave is shown, the + channel of the probe may be faulty.

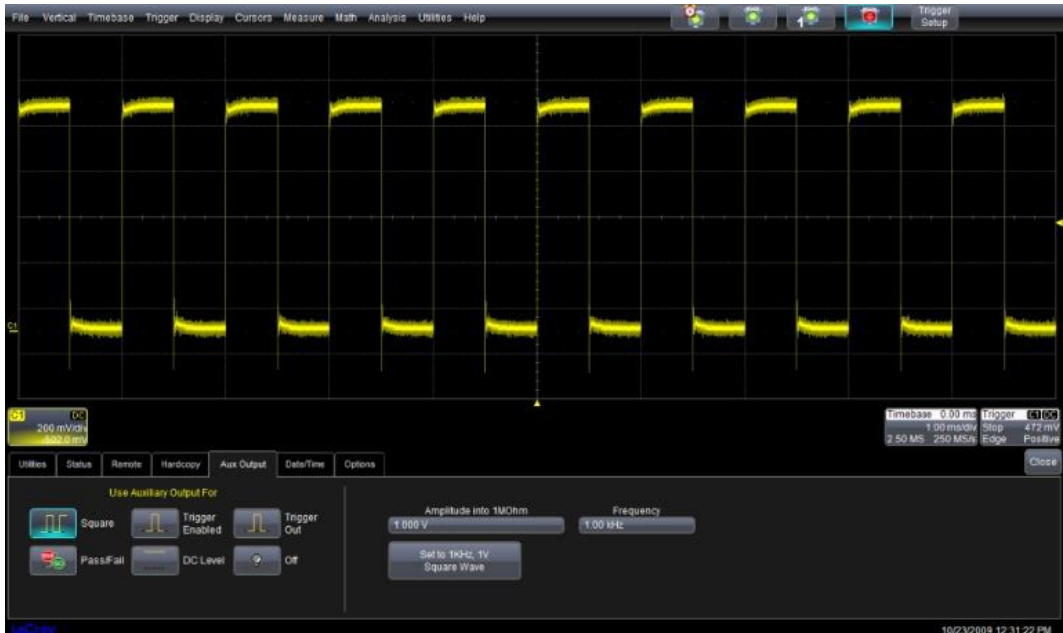

Square wave output signal

- Make desired adjustments to your oscilloscope settings and obtain a stable display.
- Adjust the tips so both touch or are almost touching.
- Connect both tips to the calibrator output signal.
- Verify a straight line is shown centered on the screen. There should be no vertical deflection, to indicate good CMRR.
- One of the channels may be at fault if a square wave or part of a square wave is shown.

This concludes the functional tests of the WaveLink High Bandwidth Differential Probe.

Performance Verification

Performance Verification Overview

This procedure can be used to verify some of the warranted characteristics of the WaveLink Differential Probe.

The recommended calibration interval for differential probes is one year. Test results can be recorded on a photocopy of **Performance Verification Test Record** (on page 70) provided at the end of this manual.

Performance Verification can be completed without removing the probe covers or exposing the user to hazardous voltages. No adjustments are provided.

In the unlikely event a probe fails performance verification, it can be sent back to the local service center or the factory. For information on returning the probe, refer to the **Returning a Product for Calibration or Service** (on page 46) or **Returning a Product to a Different Country** (on page 48) topics as needed.

This procedure tests the WL-PLINK-A or WL-2.92MM with a D1305-A, D1605-A, D2005-A, or D2505-A. All probe setups are tested at the factory for the following warranted specifications:

- **Output Zero**
- **Low frequency attenuation accuracy at low and high voltage range**
- **Rise time**

The rise time specification has dependency on characteristics of the platform/cable assembly. Therefore, traceable calibration requires verification with a specific platform/cable assembly denoted by serial number. The rise time and attenuation accuracy parameters of probe tip modules utilizing detachable tips have similar dependencies on the individual interconnect lead, which is serialized. This applies to the D1305-A, D1605-A, D2005-A, and D2505-A amplifier modules:

- The **rise time** specification for the D1305-A and D1605-A are valid with either the WL-PLINK-A or WL-2.92MM platform/cable assembly provided that they were calibrated together at the factory at time of shipment.
- The rise time for the D2005-A and D2505-A is valid with the WL-2.92MM platform/cable assembly that was provided at time of factory shipment. Due to the high BW and short rise time of the probe system, very specialized test equipment and procedures are required for performance verification of the rise time, and return to a factory service center is required.

Output zero and **attenuation accuracy** can be measured in the field and verified with any platform/cable assembly.

If the probe package includes multiple probe interconnect leads, the best practice is to complete the entire procedure for each probe interconnect lead. If more than one interconnect lead is being verified, copy and fill out a separate test record for each platform/cable assembly, amplifier module, and interconnect lead.

If the probe package includes probe interconnect leads that are not serialized to the amplifier module and platform/cable assembly, then performance may not be verifiable.

NOTE: It is recommended that the Functional Check be performed prior to the Performance Verification Procedure to assure all other non-warranted functions perform as specified. See **Quick Functional Check** (on page 68) for more information.

Required Test Equipment

The following table lists the test equipment and accessories, or their equivalents, required for performance verification of the WaveLink Series of High Bandwidth Differential Probes.

The procedure has been developed to minimize the number of parameters requiring calibration in the test instrumentation. Only the parameters listed in **boldface** in the **Minimum Requirements** column must be calibrated to the accuracy indicated.

Because the input and output connector types may vary on different brands and models of test instruments, additional adapters or cables may be required.

Description	Minimum Requirements	Test Equipment Examples
Oscilloscope, High Impedance	200 mV/div - 2 V/div scale factor 1 M Ω input impedance ProBus interface	Teledyne LeCroy: WaveMaster 8 Zi/Zi-A Series, or any Teledyne LeCroy oscilloscope with ProBus compatible 1 M Ω input
Digital Multimeter	AC: 0.2% accuracy to measure 200 mV and 2 V _{rms} @ 1 kHz 6½ digit resolution	Agilent Technologies: 34401A Fluke: 8842A-09 Keithley: 2001
Oscillator/Function Generator	Sine Wave output, adjustable from 500 mV to 4 V _{p-p} (357 mV to 2.83 V _{rms}) at 70 Hz	Stanford Research: Model DS340 Agilent Technologies: 33120A Leader: LAG-120B
Calibration Fixture ¹	See Preliminary Procedure	Teledyne LeCroy: ProLink-CF01
Calibration Fixture ²	See Preliminary Procedure	Teledyne LeCroy: LPA-2.92
Terminator, Precision, BNC	50 Ω \pm 0.05%	Teledyne LeCroy: TERM-CF01
Probe Deskew Fixture ³		Teledyne LeCroy: PCF-200

WaveLink Series Differential Probe (13-25 GHz)

Description	Minimum Requirements	Test Equipment Examples
SMA to BNC Adapter	Female SMA to male BNC	Pomona Electronics: 4289 Pasternack Enterprises: PE9073
SMA to BNC adapter	Male SMA to female BNC	Pomona Electronics: 4290 Pasternack Enterprises: PE9074
SMA to BNC Adapter	Female SMA to female BNC	Pomona Electronics: 4291 Pasternack Enterprises: PE9075
SMA to SMA Adapter ⁴	Female SMA to female SMA	Pomona Electronics: 4284 Pasternack Enterprises: PE9070
Terminator, SMA	Female SMA, 50 Ω, ½ W	Pomona Electronics: 4287 Pasternack Enterprises: PE6003
Attenuator	Male 2.4 mm to male SMA, 50 Ω, 10 dB, 12 GHz	Pasternack Enterprises: PE7045-10
BNC coaxial cable, (3 ea)	Male-male BNC, 50 Ω, 36"	Pomona Electronics: 2249-C-36 Pasternack Enterprises: PE3067-36
SMA coaxial cable, (2 ea) ⁴	Male-male SMA, 50 Ω, 36"	Pomona Electronics: 4846-K-24 Pasternack Enterprises: PE3369-36
SMA coaxial cable, (1 ea) ³	Male SMA to female SMA, 50 Ω, 36"	Pomona Electronics: 4528-K-24 Pasternack Enterprises: PE3078-36
BNC Tee connector, (2ea)	Male to dual female, BNC	Pomona Electronics: 3285 Pasternack Enterprises: PE9001
Banana Plug adapter	Female BNC to dual banana plug	Pomona Electronics: 1269 Pasternack Enterprises: PE9008
Adapter	Female 2.4 mm to female SMA	Pasternack Enterprises: PE9656
Torque Wrench	for SMA or 2.92mm connectors	

¹ Required for WL-PLINK-A verification.

² Required for WL-2.92MM verification.

³ Standard accessory included with platform/cable assembly.

⁴ Instead of using a male-to-male SMA cable with a SMA-to-SMA adapter to connect to the male end of the deskew fixture, you can use a male SMA-to-female SMA cable.

Preliminary Procedure

WaveMaster 8 Zi /Zi-A oscilloscopes contain ProBus, ProLink, and 2.92mm (on ≥ 20 GHz models) inputs, which conveniently allows this test to be performed on the oscilloscope that is used with the probe. However, other Teledyne LeCroy oscilloscopes with ProBus, ProLink, or 2.92mm inputs may also be used, since these inputs are only providing power to the probe during testing. The following instructions are for using a ProLink interface connection for the verification of a WL-PLINK-A. For verification of a WL-2.92MM, the WL-2.92MM and LPA-2.92 may be substituted instead for the WL-PLINK-A and ProLink CF01, respectively.

1. Connect the WL-PLINK-A to the input of ProLink-CF01 Calibration Fixture.
2. Remove the captive screws from the ProLink-CF01, allowing the WL-PLINK-A Calibration Fixture connectivity.

NOTE: There are no captive screws to remove on the WL-2.92MM.

3. When testing using a WL-PLINK-A, connect the output of the ProLink-CF01 Calibration Fixture to a free channel of the WaveMaster 8 Zi or 8 Zi-A oscilloscope.
4. Allow at least 20 minutes warm-up time for the WaveLink high bandwidth probe and test equipment before performing the Verification Procedure.
5. Turn on the other test equipment and allow them to warm up for the manufacturer's recommended timeframe.
6. While the instruments are reaching operating temperature, print a copy of **Performance Verification Test Record** (on page 70), and fill in the necessary data.

Most of the warranted characteristics of the WaveLink Differential Probe are valid at any temperature within the Environmental Characteristics portion of the Specification. See teledynelecroy.com for specification details. However, some of the other test equipment used to verify the performance may have environmental limitations required to meet the accuracy requirements needed for the procedure. Be sure that the ambient conditions meet the requirements of all the test instruments used in the procedure.

As specified, the low frequency attenuation accuracy is valid at a reduced temperature range from 20 to 30° C; verification, therefore, must be done at an ambient temperature within that range.

Verification Procedure

This verification procedure describes the tests, using a probe with an SI interconnect lead attached. Note that the interconnect lead does not need to be attached for this procedure.

The setup and procedure for testing Output Zero and Attenuation Accuracy is the same for WL-PLINK-A as for WL-2.92mm, except for a different oscilloscope input connection.

Output Zero

1. Connect the appropriate calibration fixture to the output of the probe to be tested (shown in the following figure).

NOTE: The output zero is not affected by the input leads, so any interconnect lead may be used for this test.

2. Provide power to the probe by connecting the ProLink-CF01 to any ProLink input of a WaveMaster 8 Zi /Zi-A oscilloscope. If connecting to a 2.92mm input, use the appropriate devices, as described in the **Preliminary Procedure** (on page 61).
3. No signal input connection to the oscilloscope is required for the Output Zero test.
4. **For the WL-PLINK-A**, connect a BNC-to-SMA adapter to the SMA output connector of the ProLink-CF01 Calibration Fixture. Then, connect the BNC end to a BNC Tee (shown in the following figure).

For the WL-2.92MM, connect a BNC to 2.92MM adapter to the 2.92mm output connector of the LPA-2.92 Calibration Fixture.

5. Connect the Precision 50 Ω Terminator, using another BNC cable, to the free end of the BNC Tee.
6. Set the DMM to DC volts.
7. Connect the Precision 50 Ω Terminator to the DMM input.
8. After a warm-up time of at least 20 minutes, measure the output voltage and record the result on the **Performance Verification Test Record** (on page 70) as **Output Voltage** (step 1).

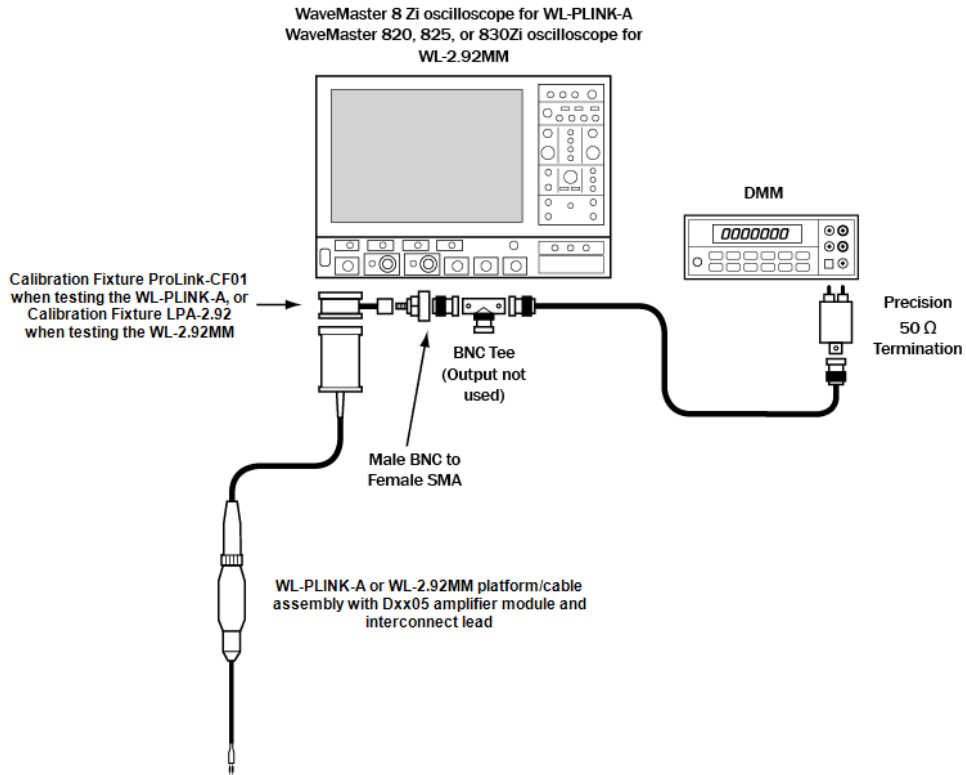

Output Zero Voltage

9. Initiate an AutoZero.
10. Wait an additional 15 minutes, then record the DMM reading to 1 mV resolution on the **Performance Verification Test Record** (on page 70) as **Output Voltage after AutoZero** (step 2).
11. Take the difference of the two readings recorded steps 8 and 10 (previous) and multiply by the Effective gain value shown in the channel attributes when the probe is attached. See **Operation with a Teledyne LeCroy Oscilloscope** (on page 19) for more information.
12. On the **Performance Verification Test Record** (on page 70), record the result as **Output Zero** (step 3).
13. Verify the absolute value of Output Zero is less than 10 mV.

DC Frequency Attenuation Accuracy

NOTE: The low-frequency attenuation accuracy needs to be verified with each interconnect lead.

Because each interconnect lead has its own serial number, it should be recorded **with the serial number of the probe tip module** on the **Performance Verification Test Record** (on page 70).

1. Connect the male end of a BNC Tee to the Sine Wave Generator output (refer to the following figure for setup). Set the generator's output voltage to 0 Volts.
2. Connect one end of a BNC cable to the BNC Tee and the other end to a Female BNC-to-Male SMA adapter.
3. Connect the male side of the BNC-to-SMA adapter to a female end of the Probe Deskew Fixture. Refer to the following figures to determine which side of the Deskew Fixture to use for the probe tip module and interconnect lead to be tested.
4. Connect another BNC cable to the free end of the BNC Tee and the other end of the cable to the Female BNC-to-Dual Banana Plug Adapter.
5. Connect the Banana Plug Adapter to the DMM input, verifying that the ground side of the adapter is connected to the low side of the DMM.
6. Attach a ProLink-CF01 Calibration Fixture to the WL-PLINK-A, or a LPA-2.92 Calibration Fixture to the WL-2.92MM.
7. Remove the captive screws from the ProLink-CF01 allowing the WL-PLINK-A Calibration Fixture connectivity.

NOTE: This step is not necessary with the LPA-2.92.

8. Connect the Calibration Fixture to Channel 1 of the oscilloscope. If using the LPA-2.92 Calibration Fixture, connect it to Channel 2. In either case, make sure that the appropriate input (either A or B) is selected in the oscilloscope channel dialog box.
9. Connect a BNC-to-SMA adapter to the SMA output connector of the ProLink-CF01 Calibration Fixture, and the BNC end to a BNC Tee (as shown in the following figure). If using the LPA-2.92 Calibration Fixture, connect a BNC to 2.92mm adapter to the 2.92mm output connector of the LPA-2.92.

10. To obtain 1 M Ω input impedance on a WL-PLINK-A or WL-2.92MM, connect the male side of the BNC Tee to a free ProBus input of a WaveMaster 8 Zi /Zi-A oscilloscope. Make sure the connected channel has the correct **B** input selected in the oscilloscope channel dialog box.
11. This input is used to observe the probe's output signal in order to verify adequate Deskew Fixture contact.

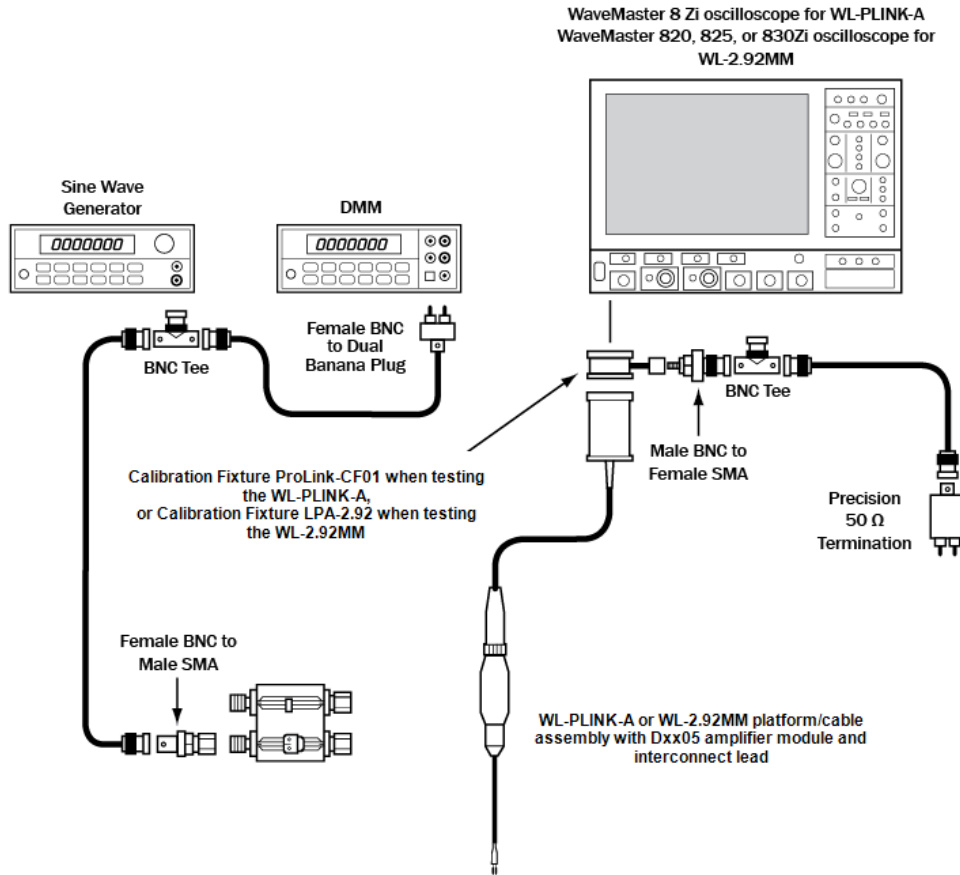

WL-PLINK-A or WL-2.92MM with an SI Lead Measuring Input Voltage

13. Connect the Precision 50 Ω Terminator via another BNC cable to the free end of the BNC Tee.
14. Leave the unused end of the Precision Terminator floating for the time being.

WaveLink Series Differential Probe (13-25 GHz)

15. Select the channel to which the BNC tee is connected and set the channel's sensitivity to 0.1 V/DIV. Verify that the input coupling is set to **DC** and the input resistance to **1 M Ω** . **Do not terminate the BNC Tee adapter into 50 Ω** .

NOTE: The following step and figure show how to connect the interconnect lead to the deskew fixture.

Connecting SI Interconnect Leads to the Fixture

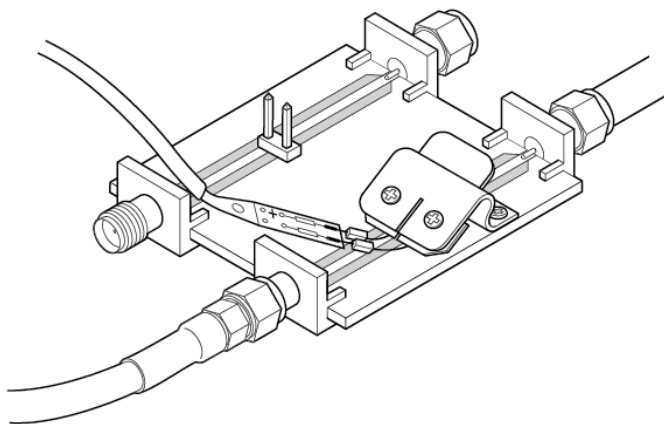

SI to Deskew Fixture Connection

1. The SI leads should be connected with the ends of the damping resistors placed under the clip. Be sure to press down on the plastic tab to lift the clip and slide the wires under the clip, verifying the **+** side is located over the center strip and the **-** side over the ground plane on either side of the center strip. Release the tab. Set the DMM to read AC.
2. Set the sine wave generator to about 70 Hz and the output 0.8 V_{p-p} (0.282 V_{rms}), as indicated on the DMM.
3. If necessary, adjust the SI tip in the fixture so the tips make good contact to get the proper amplitude (about 4 divisions) on the oscilloscope.
4. With good probe tip contacts verified, record the DMM reading to 1 mV resolution on the **Performance Verification Test Record** (on page 70) as **Probe Input Voltage** (step 4).
5. Unplug the BNC to Banana Plug Adapter from the DMM and connect the Precision 50 Ω Terminator to the DMM input (shown as follows).

6. After the DMM has stabilized, record the reading to 1 mV resolution on the **Performance Verification Test Record** (on page 70) as **Probe Output Voltage** (step 5).
7. Take the probe's attenuation into account by multiplying the reading recorded 3 steps prior (for Probe Input Voltage) by the Effective gain value shown in the channel attributes when the probe is attached. See **Operation with a Teledyne LeCroy Oscilloscope** (on page 19) for more information.
8. On the **Performance Verification Test Record** (on page 70), record the result as **Corrected Output Voltage** (step 6).
9. Divide the **Output Voltage** (obtained 2 steps prior) by the **Input Voltage** (obtained 4 steps prior). Subtract the ratio from 1.0 and multiply the result by 100% for the error percentage.

$$Error = \left(1 - \frac{Corrected\ Probe\ Output\ Voltage}{Probe\ Input\ Voltage}\right) \times 100\%$$

10. On the **Performance Verification Test Record** (on page 70), record the result to two decimal places ($\pm 0.xx\%$) as **Probe Attenuation Error** (step 7).
11. Ensure the calculated **Probe Attenuation Error** is less than $\pm 2\%$.

WaveLink Series Differential Probe (13-25 GHz)

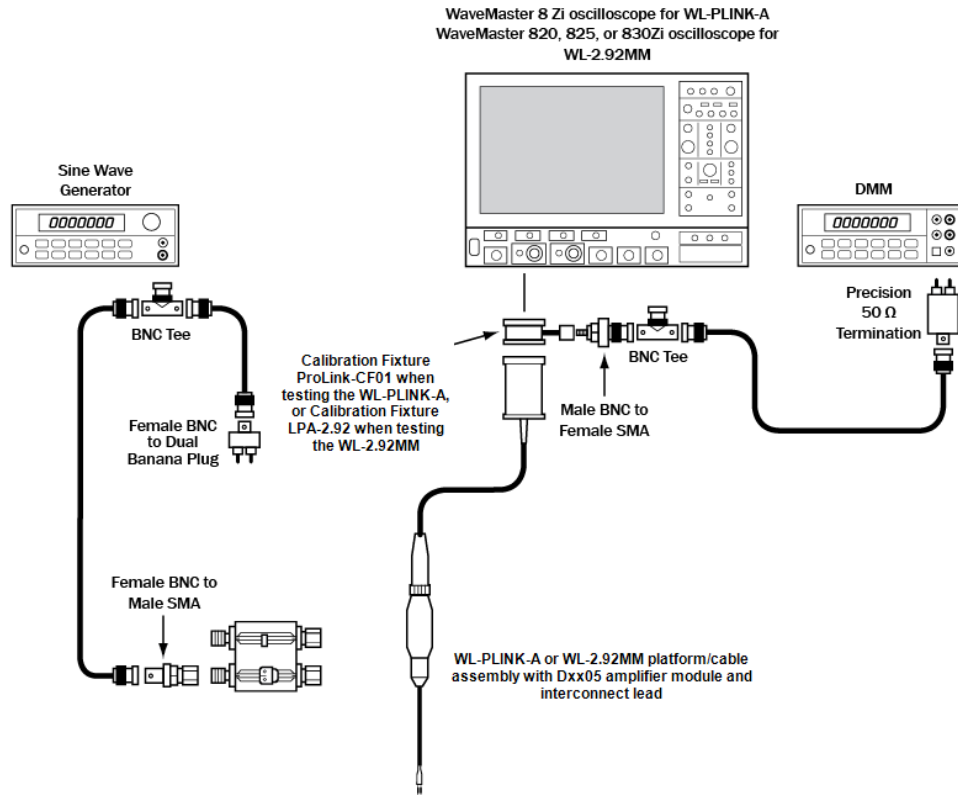

WL-PLINK-A or WL-2.92MM with an SI Lead Measuring Output Voltage.

This concludes the Performance Verification Procedure.

Quick Functional Check

This test is a simple, interim check to ensure your WaveLink High Bandwidth Differential Probe is generally functioning and hasn't experienced any significant performance changes. This test should be run after potentially damaging stresses are applied to the probe and check if the probe is still functional. It can be used for any WaveLink Model (D1305-A, D1605-A, D2005-A, D2505-A, etc.); the maximum bandwidth of the probes is not checked; however, we can safely assume no damage affecting only the bandwidth above 16 GHz.

Description	Minimum Requirements and/or Test Equipment Examples
WaveLink High Bandwidth Differential Probe	With ground lead and grabber (484010043 and 594200003).
Oscilloscope	WaveMaster, DDA, or SDA 8 Zi / Zi-A model or better.
Probe Deskew Fixture	Part number PCF-200.
50Ω SMA(m) Termination	42402730003 (Mini-Circuits ANNE-50+ or equivalent).

Use the same setup as for the **Verification Procedure** (on page 62).

1. Connect the WaveLink High Bandwidth Differential Probe to the oscilloscope input channel. Make sure the probe is recognized by the oscilloscope and the platform LED channel color matches.
2. Connect the Probe Deskew Fixture (part number PCF-200) to the Fast Edge output of the oscilloscope. Connect the 50Ω termination to the SMA(f) output of the deskew fixture.
3. Connect the SI Probe tip to the PCF-200 fixture verifying that the positive lead is connected to the fixture trace, and the other lead is connected to the fixture ground. Connect the ground lead to the fixture ground (reference the previous figure in the Connecting SI Interconnect Leads to the Fixture topic for details).
4. Set the channel on the oscilloscope to:
 - 100 mV/div
 - 0V offset
 - 10 ns/div
 - Sinx/x averaging 16 sweeps
 - Measure the amplitude and rise time of the signal
5. Check that the amplitude is about equal to 350 mV (within 20 mV) and the rise time is less than 60 ps. The first time you test a probe, you can save the trace to memory for test comparisons at a later date.
6. You might also want to save the screen to a file.

WaveLink Series Differential Probe (13-25 GHz)

NOTE: The fast edge doesn't have a very flat response, and the deskew fixture is not designed for such high bandwidth, so the aberrations seen here are mostly determined by the source and not the probe.

Performance Verification Test Record

This record can be used to record the results of measurements made during the performance verification of the WaveLink Series of Differential Probes. Photocopy this page and record the results on the copy. File the completed record as required by applicable internal quality procedures. The section in the test record corresponds to the parameters tested in the performance verification procedure. The numbers preceding the individual data records correspond to the steps in the procedure requiring the recording of data.

Results to be recorded in the column labeled **Test Result** are the actual specification limit check. The test limits are included in all of these steps. Other measurements and the results of intermediate calculations that support the limit check are to be recorded in the column labeled **Intermediate Results**.

Permission is granted to reproduce these pages for the purpose of recording test results.

NOTE: Use a new Test Record for each tested probe, probe tip module, and lead.

Items Tested

Item	Serial Number	Item	Serial Number
WL-PLINK-A		Dxx05-SI	
WL-2.92MM		Dxx05-PT	

Equipment Used

Instrument	Model	Serial Number	Calibration Due Date
Oscilloscope			
Digital Multimeter			
Sine Wave Generator			

Test Record**OUTPUT ZERO**

Step	Description	Intermediate Data	Test Result
1.	Output Voltage	V	
2.	Output Voltage after AutoZero	V	
3.	Output Zero (Test limit ≤ 10 mV)		mV

ATTENUATION ACCURACY

Step	Description	Intermediate Data	Test Result
4.	Probe Input Voltage	V	
5.	Probe Output Voltage	V	
6.	Corrected Output Voltage	V	
7.	Attenuation Error (Test limit $\leq 2\%$)		%

Reference Material

Specifications

Please refer to the Teledyne LeCroy website at teledynelecroy.com for detailed specification information.

NOTE: Specifications are subject to change without notice.

Regional Service Centers

Teledyne LeCroy Service Centers World Wide	
<p>United States and Canada - World Wide Corporate Office Teledyne LeCroy 700 Chestnut Ridge Road Chestnut Ridge, NY, 10977-6499 teledynelecroy.com Phone: 800-553-2769 or 845-425-2000 Fax: 845-578-5985 Support: contact.corp@teledynelecroy.com Sales: customersupport@teledynelecroy.com</p>	<p>United States - Protocol Solutions Group Teledyne LeCroy 3385 Scott Boulevard Santa Clara, CA, 95054 teledynelecroy.com Fax: 408-727-0800 Sales and Service: Phone: 800-909-7211 or 408-727-6600 contact.corp@teledynelecroy.com Support: Phone: 800-909-7112 or 408-653-1260 psgsupport@teledynelecroy.com</p>
<p>European Headquarters Teledyne LeCroy SA 4, Rue Moïse Marcinhes Case postale 341 1217 Meyrin 1 Geneva, Switzerland teledynelecroy.com/europe Phone: + 41 22 719 2228/ 2323/ 2277 Fax: +41 22 719 2233 contact.sa@teledynelecroy.com applications.indirect@teledynelecroy.com Protocol Analyzers: +44 12 7650 3971</p>	<p>Singapore Oscilloscopes: Teledyne LeCroy Singapore Pte Ltd. Blk 750C Chai Chee Road #02-08 Chai Chee @ Technopark Singapore 469003 Phone: ++ 65 64424880 Fax: ++ 65 64427811 Protocol Analyzers: Genetron Singapore Pte Ltd. 37 Kallang Pudding Road, #08-08 Tong Lee Building Block B Singapore 349315 Phone: ++ 65 9760-4682</p>

Teledyne LeCroy Service Centers World Wide

<p>China Teledyne LeCroy Beijing Beijing Office and Service Center Rm. 2001 - Office; Rm. 2002 - Service Center Unit A, Horizon Plaza No. 6, Zhichun Road, Haidian District Beijing 100088, China Sales: ++86 10 8280 0318 / 0319 / 0320 Service: ++86 10 8280 0245 Fax: +86 10 8280 0316</p>	<p>Taiwan Lecoln Technology Co Ltd. Far East Century Park, C3, 9F No. 2, Chien-8th Road Chung-Ho Dist., New Taipei City Taiwan Phone: ++ 886 2 8226 1366 Fax: ++ 886 2 8226 1368 sales_twn@teledynelecroy.com</p>
<p>Korea Teledyne LeCroy Korea 10th fl.Ildong Bldg. 968-5 Daechi-dong, Gangnam-gu Seoul 135-280, Korea Phone: ++ 82 2 3452 0400 Fax: ++ 82 2 3452 0490</p>	<p>Japan Teledyne LeCroy Japan Hobunsya Funchu Bldg, 3F 3-11-5, Midori-cho, Fuchu-Shi Tokyo 183-0006, Japan teledynelecroy.com/japan Phone: ++ 81 4 2402 9400 Fax: ++ 81 4 2402 9586</p>

Safety Instructions

This section contains instructions that must be observed to keep this oscilloscope accessory operating in a correct and safe condition. You are required to follow generally accepted safety procedures in addition to the precautions specified in this section.

The overall safety of any system incorporating this accessory is the responsibility of the assembler of the system.

Symbols

These symbols appear on the probe body or in this manual to alert you to important safety considerations.



Potential for damage to probe or instrument it is connected to. Attend to the accompanying information to protect against personal injury or damage. Do not proceed until conditions are fully understood and met.



Potential Electrostatic Discharge (ESD) hazard. The probe is susceptible to damage if anti-static measures are not taken.

WaveLink Series Differential Probe (13-25 GHz)

Precautions

Connect and disconnect properly. Connect probe to the measurement instrument before connecting the test leads to a circuit/signal being tested.

Use only within operational environment listed. Do not use in wet or explosive atmospheres.

Use indoors only.

Keep product surfaces clean and dry.

Be careful with sharp tips. The tips may cause bodily injury if not handled properly.

Do not operate with suspected failures. Do not use the probe if any part is damaged. Cease operation immediately and sequester the probe from inadvertent use.

Operating Environment

The accessory is intended for indoor use and should be operated in a clean, dry environment. Before using this product, ensure that its operating environment is maintained within these parameters:

Temperature: 5° to 40° C.

Humidity: Maximum relative humidity 90 % for temperatures up to 31° C decreasing linearly to 50 % relative humidity at 40° C.

Altitude: Up to 10,000 ft (3,048 m).

NOTE: Direct sunlight, radiators, and other heat sources should be taken into account when assessing the ambient temperature.

Certifications

This section contains the instrument's Electromagnetic Compatibility (EMC), Safety and Environmental certifications.

EMC Compliance

EC DECLARATION OF CONFORMITY - EMC

The probe meets intent of EC Directive 2004/108/EC for Electromagnetic Compatibility. Compliance was demonstrated to the following specifications as listed in the Official Journal of the European Communities:

EN 61326-1:2006, EN 61326-2-1:2006 EMC requirements for electrical equipment for measurement, control, and laboratory use.

Electromagnetic Emissions:

CISPR 11:2003, Radiated and Conducted Emissions Group 1, Class A ^{1 2}

Electromagnetic Immunity:

EN 61000-4-2:2001 Electrostatic Discharge, 4 kV contact, 8 kV air, 4 kV vertical/horizontal coupling planes ³

EN 61000-4-3:2006 RF Radiated Electromagnetic Field, 3 V/m, 80-1000 MHz; 3 V/m, 1400 MHz - 2 GHz; 1 V/m, 2 GHz - 2.7 GHz ³

1 Emissions which exceed the levels required by this standard may occur when the probe is connected to a test object.

2 This product is intended for use in nonresidential areas only. Use in residential areas may cause electromagnetic interference.

3 Meets Performance Criteria “B” limits of the respective standard: during the disturbance, product undergoes a temporary degradation or loss of function or performance which is self-recoverable.

European Contact:

Teledyne LeCroy Europe GmbH
Waldhofer Str 104
D-69123 Heidelberg
Germany
Tel: (49) 6221 82700

AUSTRALIA & NEW ZEALAND DECLARATION OF CONFORMITY—EMC

Probe complies with the EMC provision of the Radio Communications Act per the following standards, in accordance with requirements imposed by Australian Communication and Media Authority (ACMA):

CISPR 11:2003 Radiated and Conducted Emissions, Group 1, Class A, in accordance with EN61326-1:2006 and EN61326-2-1:2006.

Australia / New Zealand Contacts:

Vicom Australia Ltd.
1064 Centre Road
Oakleigh, South Victoria 3167
Australia

Vicom New Zealand Ltd.
60 Grafton Road
Auckland
New Zealand

Safety Compliance

EC DECLARATION OF CONFORMITY – LOW VOLTAGE

The probe meets intent of EC Directive 2006/95/EC for Product Safety. Compliance was demonstrated to the following specifications as listed in the Official Journal of the European Communities:

EN 61010-1:2010 Safety requirements for electrical equipment for measurement, control, and laboratory use – Part 1: General requirements

EN 61010-2:030:2010 Safety requirements for electrical equipment for measurement, control, and laboratory use – Part 2-030: Particular requirements for testing and measuring circuits

EN 61010-031/A1:2008 Safety requirements for electrical equipment for measurement, control, and laboratory use – Part 031: Safety requirements for hand-held probe assemblies for electrical measurement and test.

Environmental Compliance

END-OF-LIFE HANDLING



The instrument is marked with this symbol to indicate that it complies with the applicable European Union requirements to Directives 2002/96/EC and 2006/66/EC on Waste Electrical and Electronic Equipment (WEEE) and Batteries.

The instrument is subject to disposal and recycling regulations that vary by country and region. Many countries prohibit the disposal of waste electronic equipment in standard waste receptacles. For more information about proper disposal and recycling of your Teledyne LeCroy product, please visit teledynelecroy.com/recycle.

RESTRICTION OF HAZARDOUS SUBSTANCES (ROHS)

This instrument has been classified as Industrial Monitoring and Control Equipment, and is outside the scope of the 2011/65/EU RoHS Directive (Exempt until July 2017, per Article 4).

ISO Certification

Manufactured under an ISO 9000 Registered Quality Management System. Visit teledynelecroy.com to view the certificate.

Probe Input Impedance and Loading

Attaching any probe to a test circuit adds some loading to the circuit under test. In most applications the high impedance of the probe, compared to the impedance of the circuit under test, imparts insignificant load to the test circuit. However, at very high frequencies the capacitive reactance of the Probe Tip Module or Interconnect Lead may load the circuit enough to affect the measurement. These probes are designed to minimize these effects at high frequencies. The SI Interconnect Lead tip uses a construction in which the tip termination consists of a damping resistor with very short lead length (to minimize inductance) that is soldered to the circuit. These damping resistors connect to a special distributed resistor on the lead. The distributed resistors compensate for the inherent transmission loss of the probe system. The result is very broad frequency response with relatively high impedance. Refer to the figures in this topic for equivalent input circuit information.

These circuits represent the aggregate load placed on the test circuit, but not the actual input circuit of the probe. For critical applications, you can enter the information of your module or lead into SPICE or some other simulator to accurately represent the probe loading.

NOTE: To avoid degrading the high frequency performance of the probe **do not** extend the input leads on the solder-in interconnect lead tip.

Equivalent Circuit Model - Dxx05-A Probe with Dxx05-SI

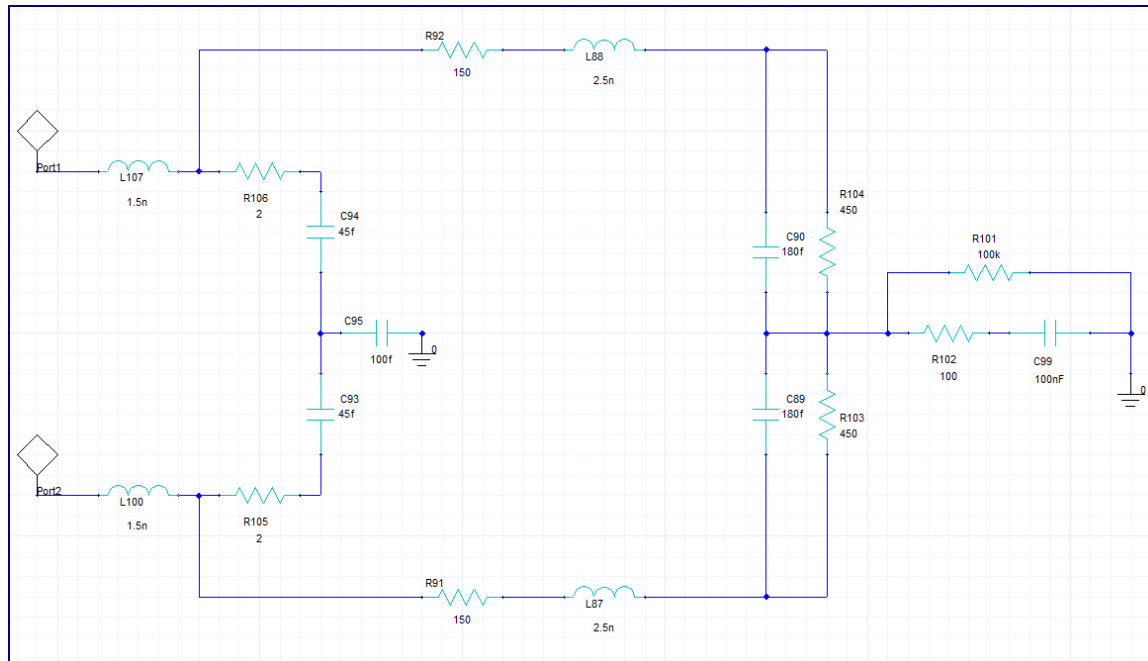

Probe Impedance - Dxx05-A Probe with Dxx05-SI

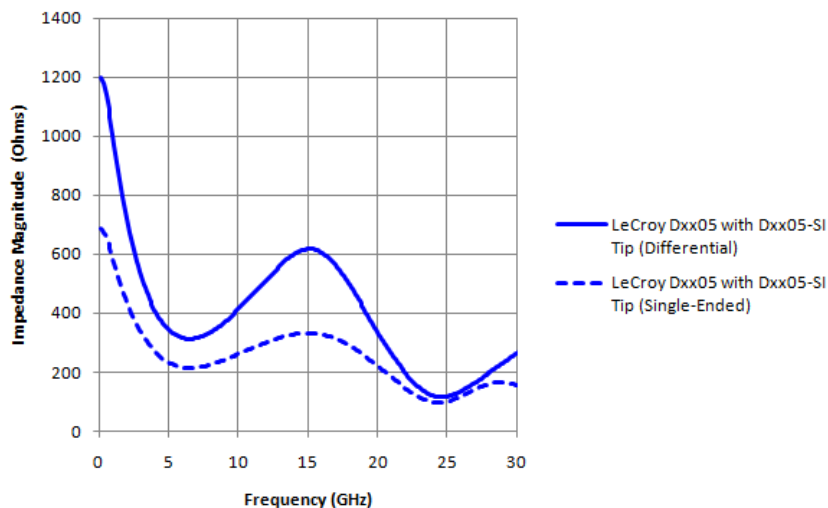

Typical probe input impedance magnitude as a function of log frequency for differential and single-ended (one lead grounded) configuration.

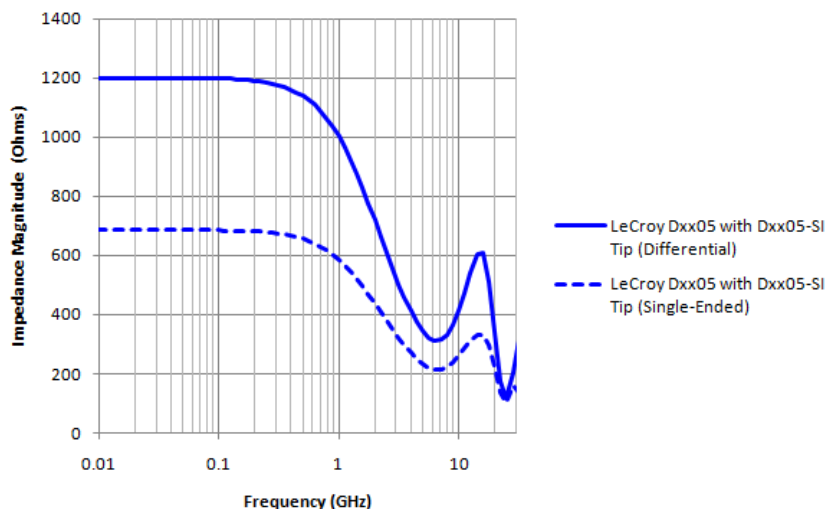

Typical probe input impedance magnitude as a function of frequency for differential and single-ended (one lead grounded).

WaveLink Series Differential Probe (13-25 GHz)

Equivalent Circuit Model - Dxx05-A Probe with Dxx05-PT

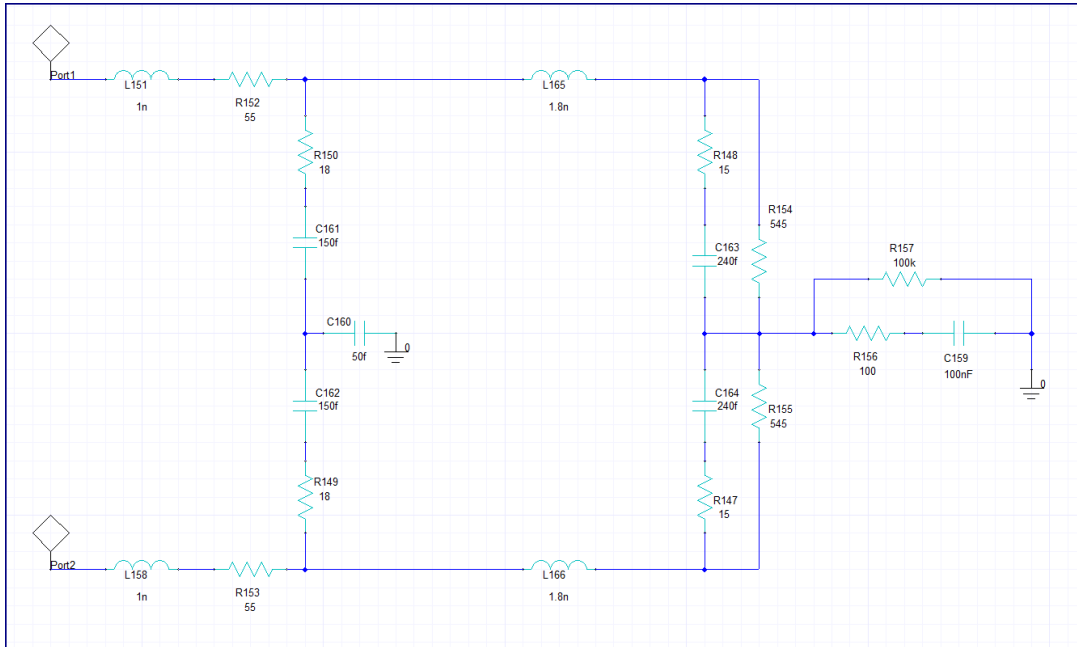

Probe Impedance - Dxx05-A Probe with Dxx05-PT

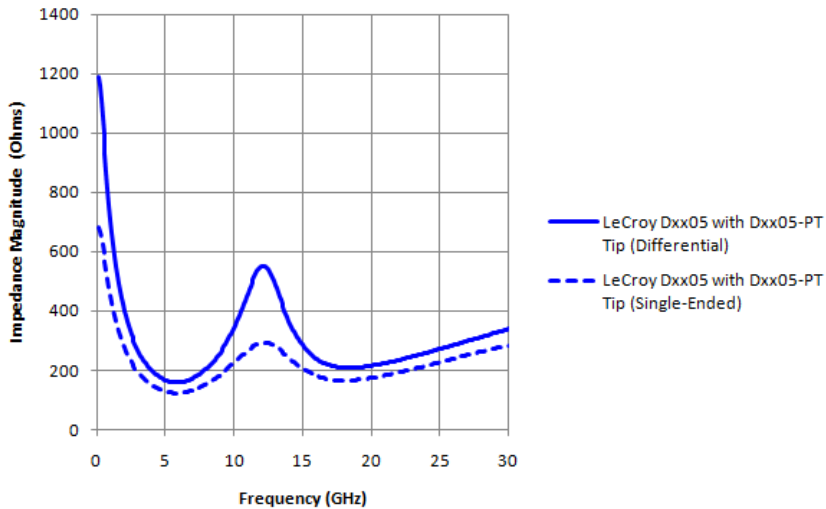

Typical probe input impedance magnitude as a function of log frequency for differential and single-ended (one lead grounded) configuration.

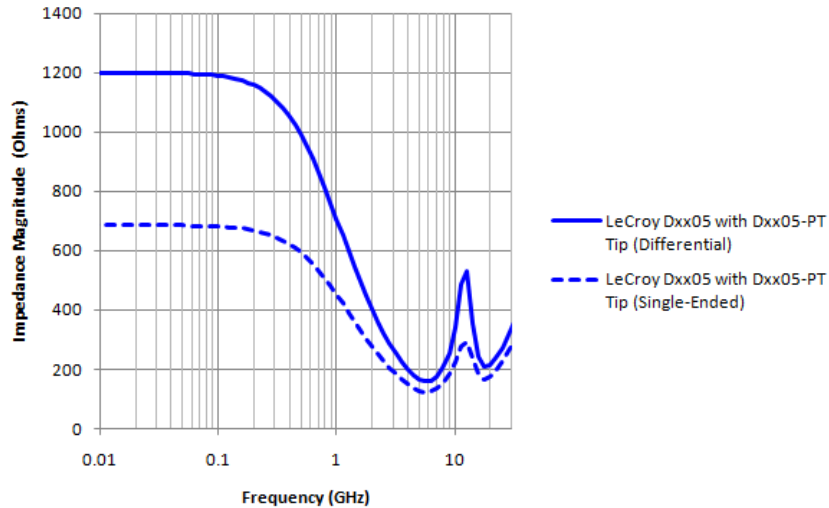

Typical probe input impedance magnitude as a function of frequency for differential and single-ended (one lead grounded).

Differential Mode and Common Mode

Differential probes sense the voltage difference which appears between the + input and – input. This voltage is referred to as the Differential Mode or Normal Mode voltage. The voltage component which is referenced to earth and is identical on both inputs is rejected by the amplifier. This voltage is referred to as the Common Mode voltage and can be expressed as:

$$V_{CM} = \frac{V_{+input} + V_{-input}}{2}$$

Differential Mode Range and Common Mode Range

Differential Mode range is the maximum signal that can be applied between the + and - inputs without overloading the amplifier/amplifier, which otherwise would result in clipping or distorting of the waveform measured by the oscilloscope.

The Common Mode Range is the maximum voltage with respect to earth ground that can be applied to either input. Exceeding the common mode range can result in unpredictable measurements. Because the Common Mode signal is normally rejected, and not displayed on the oscilloscope, the user needs to be careful to avoid accidentally exceeding the common mode range.

WaveLink Series Differential Probe (13-25 GHz)

Because the input signal of a differential amplifier is not referenced to ground, the concept of V_{peak} versus $V_{\text{peak-peak}}$ may be confusing.

With a ground referenced signal, V_{peak} is the maximum instantaneous voltage amplitude the signal will have with respect to ground. In a differential system, there is no ground reference. Therefore, the Differential Mode Range refers to the maximum instantaneous amplitude of the signal difference between the positive input and the negative input. Since most amplifiers have symmetrical bipolar inputs, the value is generally expressed as an absolute value, and can have either polarity.

For example, an amplifier with a differential mode rating of ± 1 V can have a maximum voltage difference appearing at any instant in time of 1 V between the inputs. The polarity could be either positive or negative. However, this does not imply that the number can be doubled to 2 volts. For clarity, consider the following table of absolute voltages applied to the inputs of a WaveLink D1605 differential amplifier that has a differential mode range or ± 800 mV and a common mode range of ± 4 V:

Voltage on + input to ground	Voltage on - input to ground	Difference	Comment
+1.5 V	+0.8 V	+0.7 V	OK: within ± 800 mV range
-1.5 V	-0.8 V	-0.7 V	OK: within ± 800 mV range
+0.8 V	-0.1 V	+0.9 V	Out of range: exceeds ± 800 mV
+1.0 V	-1.0 V	+2.0 V	Out of range: exceeds ± 800 mV
+6.5 V	+6.0 V	0.5 V	Exceeds ± 4 V common mode range
$1.5 V_{\text{pk-pk}}$ sine	Ground	$0.75 V_{\text{peak}}$	OK: within ± 800 mV range

Some amplitude is specified as peak to peak. The differential amplifier peak-to-peak range is twice the peak differential mode range specification (at any instant in time) as the maximum voltage amplitude signal is one-half of the peak-to-peak value.

In a balanced differential system, the signal on each output is an inverted copy of the other input. For example, an LVDS system may have a pair of outputs, each of which has a voltage swing of 0 to +370 mV. A logic 1 would be represented when the + output is at +370 mV, while the - output is at 0 V. A logic zero is the opposite polarity: the + output at 0 V and the - output at +370 mV. Note that

even though both outputs swing 370 mV, the maximum difference voltage between them at any instant is still within ± 370 mV. So, this signal could be measured with a differential amplifier that has a differential mode range of ± 400 mV.

Common Mode Rejection Ratio

The ideal differential probe/amplifier would sense and amplify only the differential mode voltage component and reject the entire common mode voltage component. Real differential amplifiers are not perfect, and a small portion of the common mode voltage component appears at the output. Common Mode Rejection Ratio (CMRR) is the measure of how much the amplifier rejects the common mode voltage component. CMRR is equal to the differential mode gain (or normal gain) divided by the common mode gain. Common mode gain is equal to the output voltage divided by the input voltage when both inputs are driven by only the common mode signal. CMRR can be expressed as a ratio (e.g., 10,000:1) or implicitly in dB (e.g., 80 dB). Higher numbers indicate greater rejection (better performance).

The first order term determining the CMRR is the relative gain matching between the + and – input paths. Obtain high CMRR values by precisely matching the input attenuators in a differential amplifier. The matching includes the DC attenuation and the capacitance which determines the AC attenuation. As the frequency of the common mode component increases, the effects of stray parasitic capacitance and inductance in determining the AC component become more pronounced. The CMRR becomes smaller as the frequency increases. Therefore, the CMRR is usually specified in a graph of CMRR versus common mode frequency.

The common mode frequency in these graphs is assumed to be sinusoidal. In real life applications, the common mode signal is seldom a pure sine wave. Signals with pulse wave shapes contain frequency components much higher than the repetition rate may suggest. This makes it very difficult to predict actual performance in the application for CMRR-versus-frequency graphs. The practical application of these graphs is to compare the relative common mode rejection performance between different probes and amplifiers.

Offset

The offset for the WaveLink High Bandwidth Series probes (D1305-A, D1605-A, D2005-A, and D2505-A) is in the probe amplifier. Thus, these probes have full offset capability over their entire V/Div range.

When the WaveLink series probe is used with a Teledyne LeCroy WaveMaster 8 Zi / Zi-A or similar oscilloscope equipped with ProLink or 2.92mm interface, the probe offset is controlled with the channel **OFFSET** knob.

Sometimes it may be desirable to display a waveform as a reference signal where a large display amplitude may not be necessary. Perhaps a timing reference when amplitude details are not needed. In such a case, the oscilloscope's zoom function can be used to reduce the displayed height of the reference signal. (Refer to your oscilloscope's online help for operation of the zoom function.)

Dynamic Range

WaveLink High Bandwidth D1305-A, D1605-A, D2005-A, and D2505-A probes have no gain or attenuation control. However, WL-PLINK-A and WL-2.92MM do provide gain and attenuation controls.

The system attenuation is fixed at approximately 3.5 to 4.5, depending on model. The actual gain value for each probe is indicated in the probe dialog box, which is displayed when the probe is connected to the scope.

The WaveLink series probes are always DC coupled (no AC coupling is provided). Therefore, care must be exercised to avoid exceeding the common mode range. Because the common mode signal is rejected by the probe and is not displayed, changes in the amplitude of the common mode component are not apparent to the user. Exceeding the common mode range may introduce distortion to the probe's output signal.

Index

A

Amplifier, 9, 12
 AutoColor, 28
 AutoZero, 29

C

Cleaning, 39
 Common, 83
 Complete PS Probe System Kit, 12
 Connecting, 16, 17, 18, 66
 Connection Guides, 37
 Consumables, 48
 Correctly Replacing Carbon Composite
 Resistive Pogo-Pin Tips in Dxx05-PT, 42

D

DC Frequency Attenuation Accuracy, 64
 Differential, 81
 Differential Amplifier Small Tip Module with
 Solder-In Interconnect Leads, 7
 Dxx0, 31

E

Equipment, 71
 Equivalent Circuit Models, 77

EZ Probe Positioner, 30

F

FreeHand Probe Holder, 29
 Functional, 54

H

Handling the Probe, 16

I

Introduction, 1
 Items, 71

L

Long Interconnect Extender, 31
 LPA 2.92 to ProLink Adapter, 7

M

Modular, 2

O

operating environment, 74
 Operation, 19
 Output, 62

WaveLink Series Differential Probe (13-25 GHz)

	P	Service, 46
Performance, 58		Setting Matched Replacement Pogo-Pin Tip Ω
Platform, 4, 28		Values Using the Dxx05-PT Pogo-Pin
Platform/Cable Assembly Mounting Kit, 35		Replacement Software Utility, 43
Positioner Browser Probe Tip, 11		Solder, 22
Positioner Tip Browser (Dxx05-PT), 26		Solder-In Interconnect Lead, 10
Positioning, 27		Specifications, 72
Positioning Tools, 29		System, 14
Preliminary, 61		
Probe, 6		T
Probe Deskew Fixtures, 38		technical support, 85
		Test, 54, 71
		Tip, 32
	R	Tip Retaining Clip, 32
Required, 59		
Returning, 46, 48		V
		Verification, 62
	S	
Safety, 73		



700 Chestnut Ridge Road
Chestnut Ridge, NY 10977
USA

www.teledynelecroy.com