

### PROTECTION PRODUCTS - MicroClamp®

#### Description

The μClamp®3601P is a high-surge transient voltage suppressor (TVS) optimized for protection of sensitive digital sensors used in proximity switches and industrial control applications. The μClamp3601P protects the components from over-voltages caused by **Electro-Static Discharge (ESD)**, **Electrical Fast Transients (EFT)**, and **Tertiary Lightning**.

The μClamp3601P features a working voltage of 33 volts with a minimum breakdown voltage of 34 volts. They are rated to handle a continuous forward current of up to 260mA with a low forward voltage drop of less than 1 volt ( $I_F = 200\text{mA}$ ). They are designed with high surge capability (2 Amps at  $t_p = 1.2/50\mu\text{s}$ ) and a low clamping voltage of <60V.

The μClamp3601P is in an 2-pin SLP1006P2 package. It measures 1.0 x 0.6 x 0.5mm. The leads are spaced at a pitch of 0.65mm and are finished with lead-free NiPdAu. Each device will protect one line operating at 33 volts. The small size and unique features of the μClamp3601P make it ideal for protection of DC high-side proximity switches in industrial and automotive applications.

The μClamp3601P is qualified to AEC-Q100 Grade1.

#### Features

- ◆ Transient protection for data and power lines to **IEC 61000-4-2 (ESD) ±20kV (air), ±15kV (contact)**
- ◆ **IEC 61000-4-4 (EFT) 40A (5/50ns)**
- ◆ **IEC 61000-4-5 (Lightning) 2A (1.2/50μs)**
- ◆ Ultra-small package
- ◆ Bidirectionally protects one data line
- ◆ Low clamping voltage
- ◆ Working voltage: 33V
- ◆ Low leakage current
- ◆ Solid-state silicon-avalanche technology
- ◆ Qualified to AEC-Q100 Grade1

#### Mechanical Characteristics

- ◆ SLP1006P2 package
- ◆ Pb-Free, Halogen Free, RoHS/WEEE Compliant
- ◆ Nominal Dimensions: 1.0 x 0.6 x 0.5 mm
- ◆ Lead Finish: NiPdAu
- ◆ Molding compound flammability rating: UL 94V-0
- ◆ Marking: Marking code, cathode band
- ◆ Packaging: Tape and Reel

#### Applications

- ◆ Two, Three, and Four Wire DC High-Side Proximity Switches
- ◆ Digital Sensor Input Protection
- ◆ Industrial Controls
- ◆ 24V - 33V DC Supply Protection
- ◆ Automotive Applications

#### Dimensions

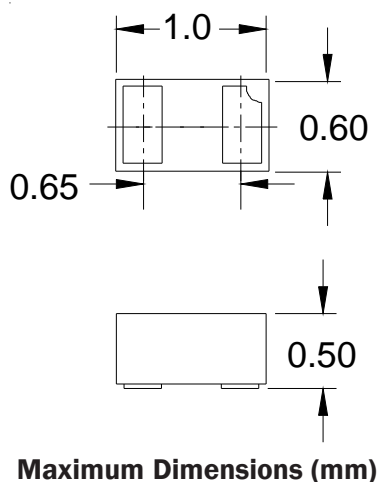

#### Schematic & Pin Configuration

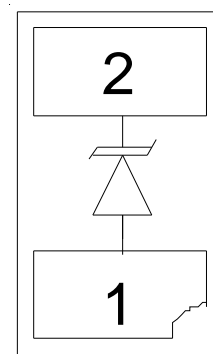

SLP1006P2 (Bottom View)

**PROTECTION PRODUCTS**
**Absolute Maximum Ratings**

Rating	Symbol	Value	Units
Peak Pulse Power ( $t_p = 8/20\mu s$ )	$P_{pk}$	170	Watts
Peak Pulse Power ( $t_p = 1.2/50\mu s$ )	$P_{pk}$	125	Watts
Peak Pulse Current ( $t_p = 1.2/50\mu s$ )	$I_{pp}$	2	A
ESD per IEC 61000-4-2 (Air) ESD per IEC 61000-4-2 (Contact)	$V_{ESD}$	+/- 20 +/- 15	kV
Continuous Forward Current	$I_{FMAX}$	260	mA
Operating Temperature	$T_J$	-40 to +125	°C
Storage Temperature	$T_{STG}$	-55 to +150	°C

**Electrical Characteristics (T=25°C unless otherwise specified)**

Parameter	Symb-ol	Conditions	Minimum	Typical	Maximum	Units
Reverse Stand-Off Voltage	$V_{RWM}$				33	V
Reverse Breakdown Voltage	$V_{BR}$	$I_t = 1mA$	T=25 °C	36		V
			T=-40 °C to 125 °C	34		
Reverse Leakage Current	$I_R$	$V_{RWM} = 33V$	T=25 °C		1	µA
			T=125 °C			
Forward Voltage	$V_F$	$I_F = 200mA$			1	V
Clamping Voltage	$V_C$	$I_{pp} = 2A, t_p = 1.2/50\mu s$			60	V
Junction Capacitance	$C_j$	$V_R = 0V,$ $f = 1MHz$	T=25 °C		25	pF
			T=-40 °C to 125 °C			

## PROTECTION PRODUCTS

### Typical Characteristics

#### Non-Repetitive Peak Pulse Power vs. Pulse Time

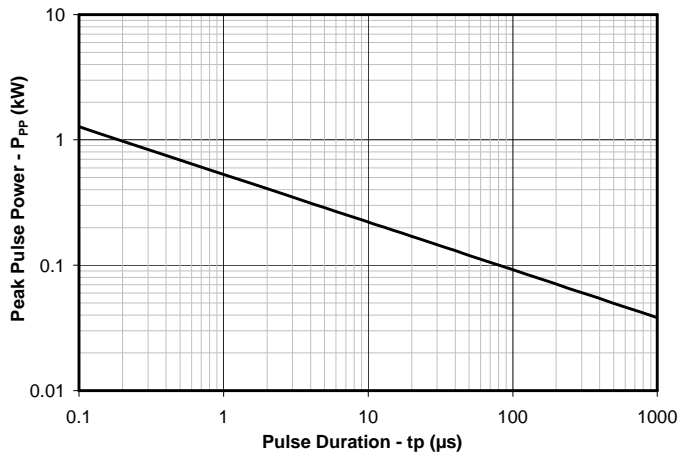

#### Power Derating Curve

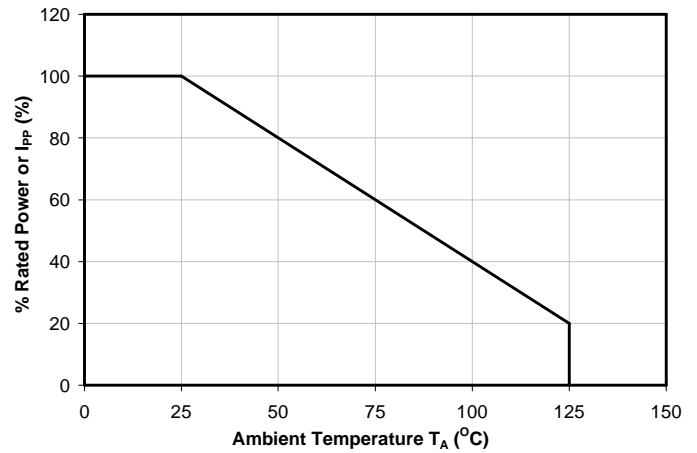

#### Clamping Voltage vs. Peak Pulse Current

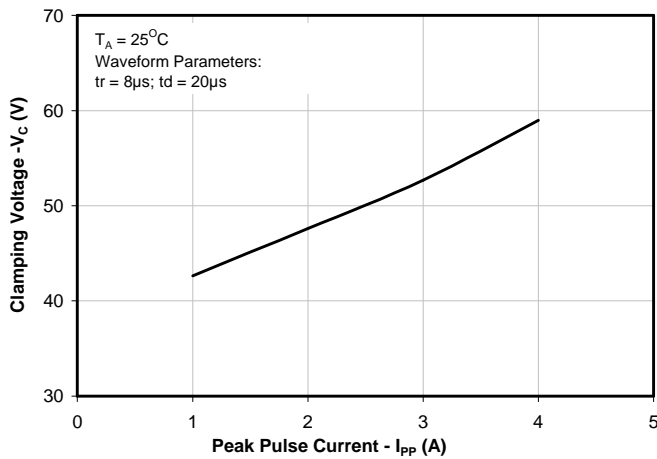

#### ESD Clamping (8kV Contact per IEC 61000-4-2)

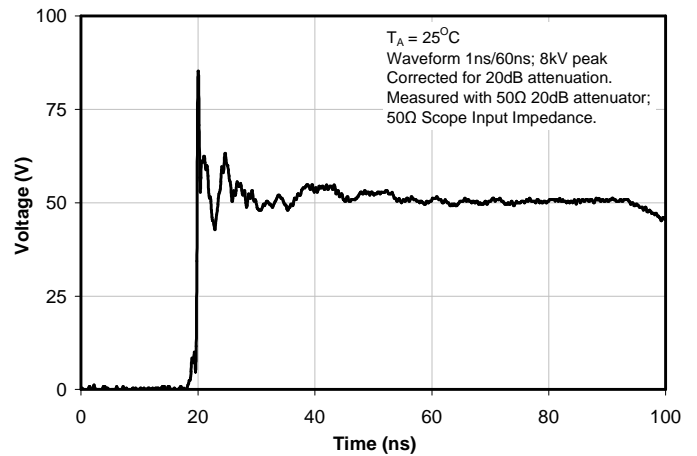

#### Forward Voltage vs. Forward Current

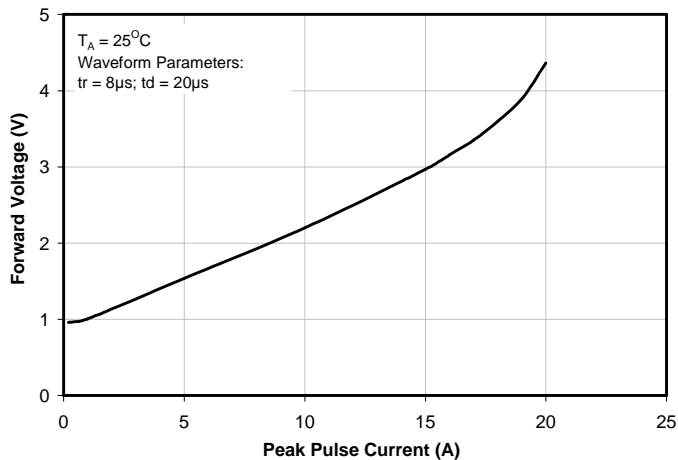

#### Junction Capacitance vs. Reverse Voltage

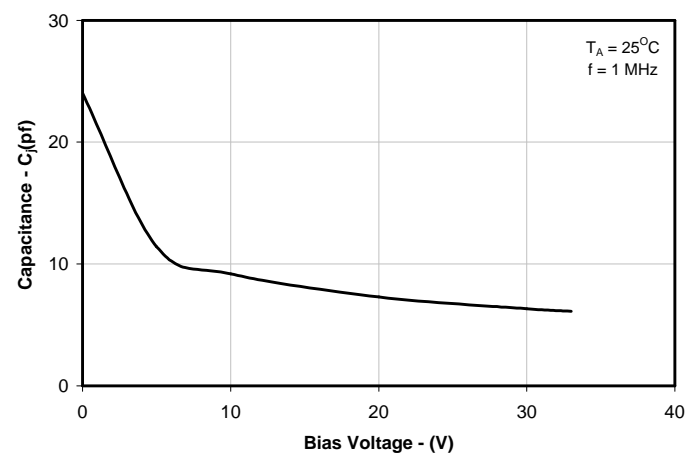

## PROTECTION PRODUCTS

### Typical Characteristics

#### Typical Positive Clamping Voltage vs Surge Voltage

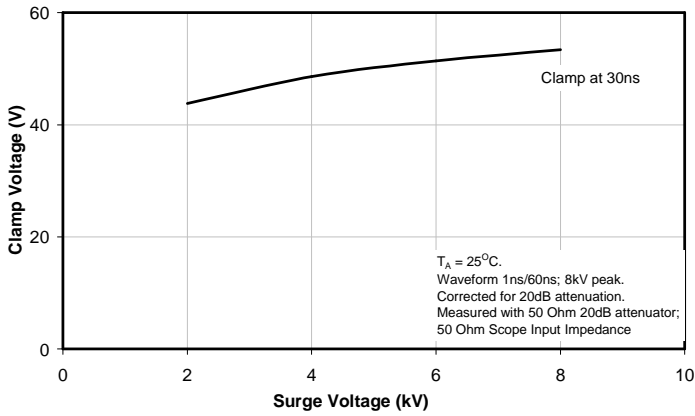

#### Typical Negative Clamping Voltage vs Surge Voltage

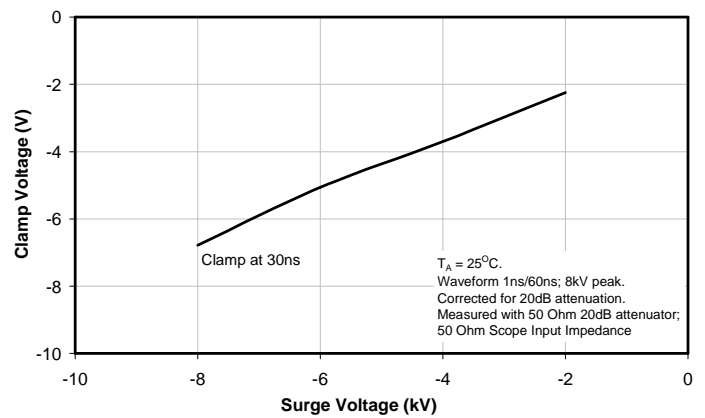

#### Typical Junction Capacitance vs Temperature

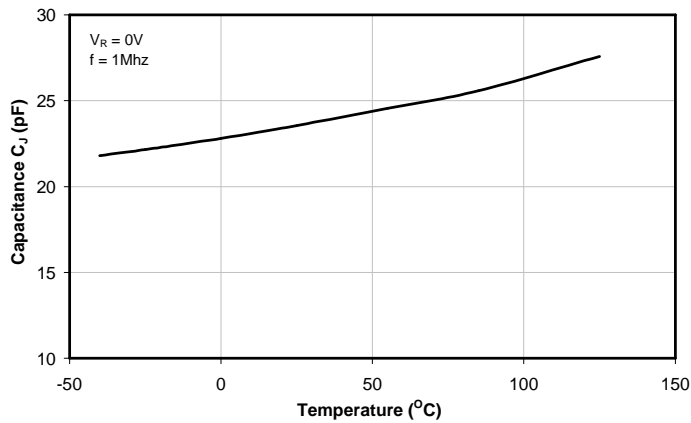

#### Typical Leakage Current vs Reverse Voltage

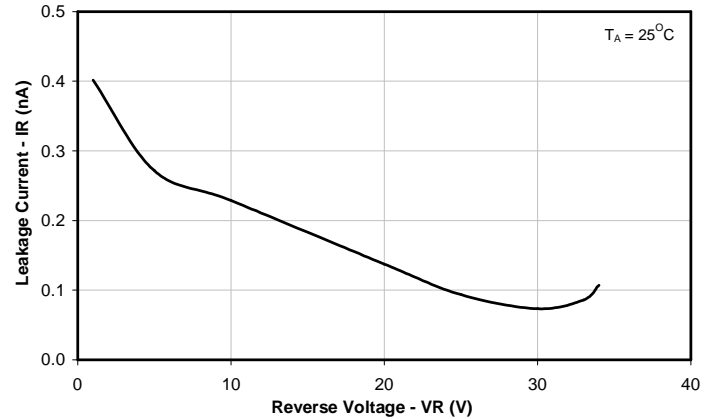

#### Typical Leakage Current vs Temperature

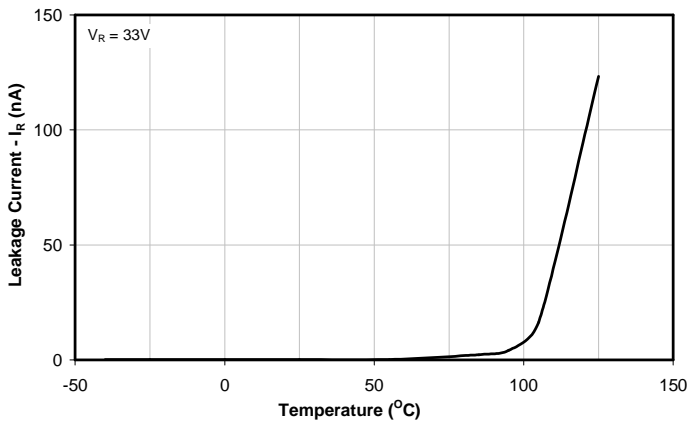

#### Typical Breakdown Voltage vs Temperature

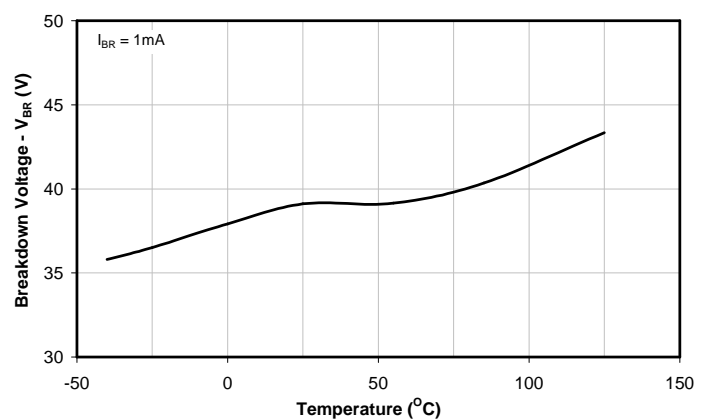

## PROTECTION PRODUCTS

### Typical Characteristics

#### Typical Insertion Loss

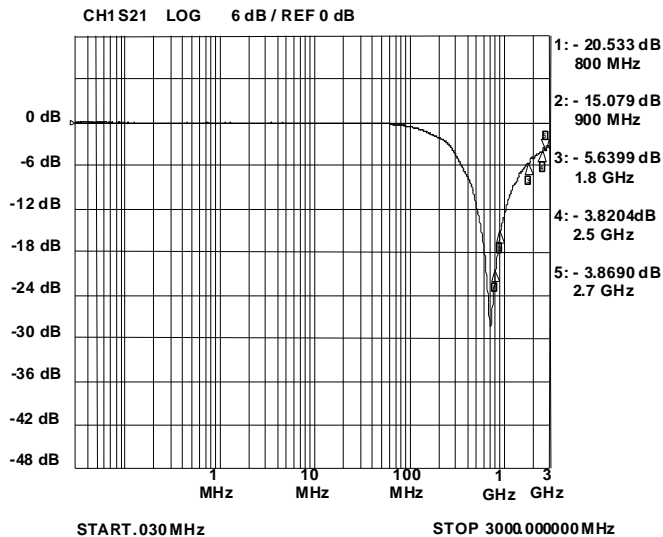

### Applications Information

#### Device Connection for Protection of Two, Three, and Four Wire Proximity Switches

Digital sensors help to bridge the gap between the physical world and the digital world in applications such as computer controlled factory automation. In such environments, transient voltages can easily disrupt or damage sensitive sensor inputs. The  $\mu$ Clamp3601P provides transient voltage protection for the digital sensors to ESD, lightning, and CDE events.

The  $\mu$ Clamp3601P is designed to meet the high surge capability and low clamping voltage needed to protect the ASIC and control logic used in proximity switches. The  $\mu$ Clamp3601P provides protection for the power and I/O lines.

#### Device Schematic & Pin Configuration

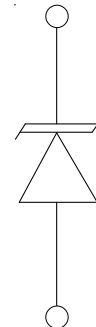

#### Application Example

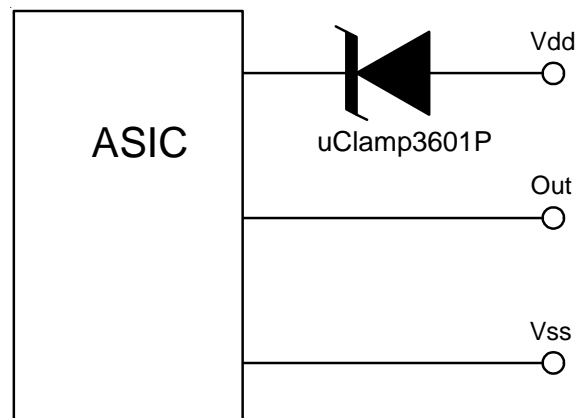

PROTECTION PRODUCTS

Outline Drawing - SLP1006P2

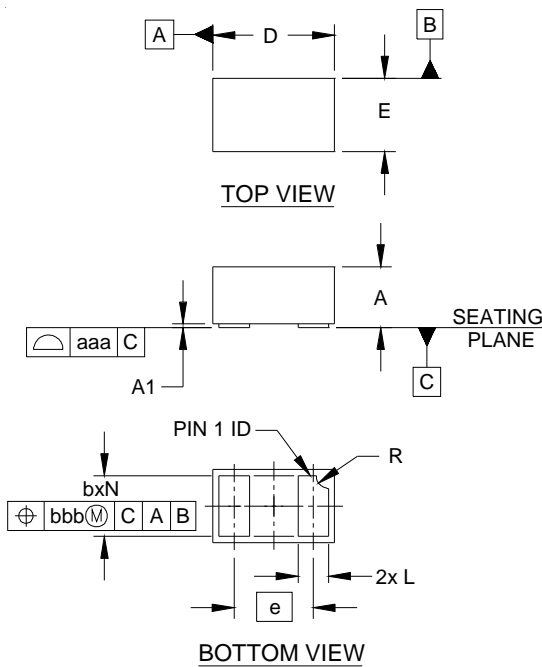

DIM	INCHES			MILLIMETERS		
	MIN	NOM	MAX	MIN	NOM	MAX
A	.016	.020	.022	0.40	0.50	0.55
A1	.000	.001	.002	0.00	0.03	0.05
b	.018	.020	.022	0.45	0.50	0.55
D	.035	.039	.043	0.90	1.00	1.10
E	.020	.024	.028	0.50	0.60	0.70
e	.026 BSC			0.65 BSC		
L	.008	.010	.012	0.20	0.25	0.30
R	.002	.004	.006	0.05	0.10	0.15
N	2			2		
aaa	.003			0.08		
bbb	.004			0.10		

NOTES:

1. CONTROLLING DIMENSIONS ARE IN MILLIMETERS (ANGLES IN DEGREES).

Land Pattern - SLP1006P2

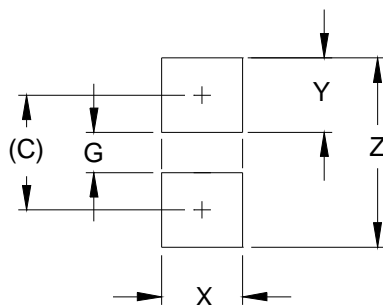

DIM	DIMENSIONS	
	INCHES	MILLIMETERS
C	(.033)	(0.85)
G	.012	0.30
X	.024	0.60
Y	.022	0.55
Z	.055	1.40

NOTES:

1. CONTROLLING DIMENSIONS ARE IN MILLIMETERS (ANGLES IN DEGREES).
2. THIS LAND PATTERN IS FOR REFERENCE PURPOSES ONLY. CONSULT YOUR MANUFACTURING GROUP TO ENSURE YOUR COMPANY'S MANUFACTURING GUIDELINES ARE MET.

## PROTECTION PRODUCTS

### Marking

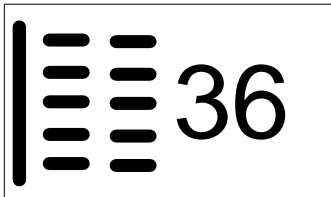

Notes:

1) Marking will also include line matrix date code

### Ordering Information

Part Number	Qty per Reel	Reel Size
uClamp3601P.TNT	10,000	7 Inch

Notes:

1) MicroClamp, uClamp and  $\mu$ Clamp are trademarks of Semtech Corporation

### Tape and Reel Specification

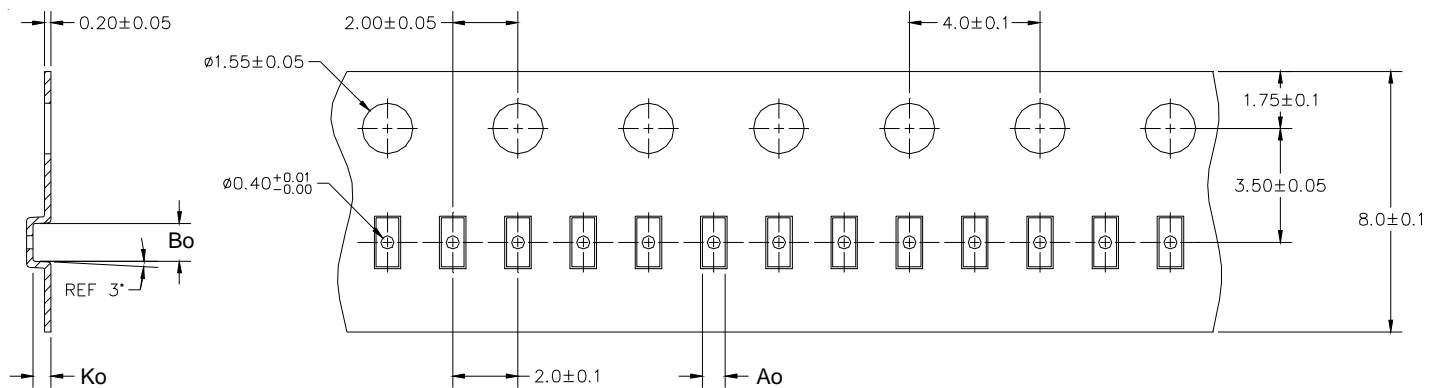

### Device Orientation in Tape

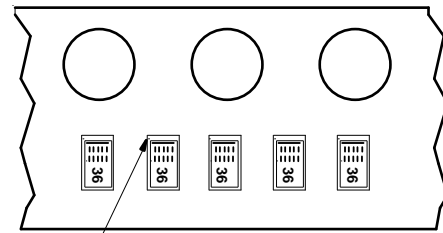

Cathode Band Location  
(Towards Sprocket Holes)

A0	B0	K0
0.69 +/-0.10 mm	1.19 +/-0.10 mm	0.66 +/-0.10 mm

Note: All dimensions in mm unless otherwise specified

### Contact Information

Semtech Corporation  
 Protection Products Division  
 200 Flynn Rd., Camarillo, CA 93012  
 Phone: (805)498-2111 FAX (805)498-3804