



Luminus Horticulture Starboards

Industry Leading High Powered LED Starboards

Data Sheet

Version 1.0

Lean & Fast

- Industry leading efficiency across the spectrum of high power color and white LEDs
- Horticulture LEDs specifically selected for the highest performance at a given color
- Light output and efficiency evaluated at elevated drive current and temperature
- Specific wavelengths targeted within the PAR range for optimized plant growth
- Create multiple spectral configurations quickly and easily

Made Smarter

Ideal for horticulture lighting applications, the Opulent Americas starboards, built with high power white and color LED technology, deliver high efficacy across the PAR range. Specifically selected from a portfolio of color options for various stages of plant growth, including white light to achieve a similar outcome to natural sunlight. The variety of color options and easy set-up allow for flexibility, quick adjustments to support different growth phases, rapid prototyping and sampling of the latest LEDs in an easy to use footprint.



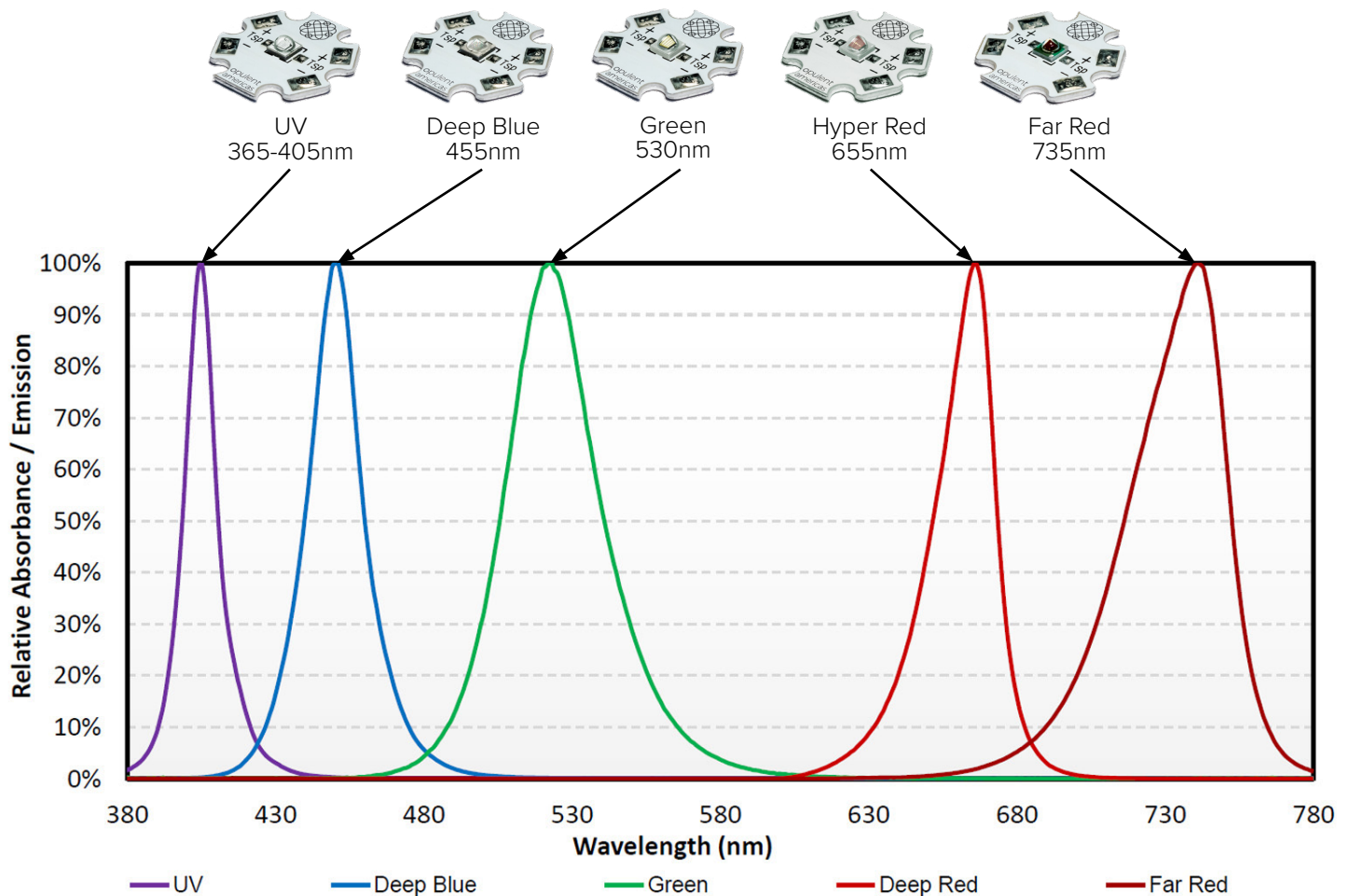

Spectral Power Distribution



Luminus Horticulture Starboards

Product Selection Guide

Color	Part Number	Description	Beam Angle	Peak Wave length	Vf	Flux (mW)	uMol/s	uMol/J
					@ 500mA, Tj 25C			
	LST1-01G01-UV01-00	Starboard, Luminus SST-10-UV-A130, 365nm	130°	365nm	3.6	875	2.69	1.49
 UV 365 to 405nm	LST1-01G01-UV02-00	Starboard, Luminus SST-10-UV-A130, 385nm	130°	385nm	3.4	1015	3.24	1.91
	LST1-01G01-UV03-00	Starboard, Luminus SST-10-UV-A130, 395nm	130°	395nm	3.4	1015	3.35	1.97
	LST1-01G01-UV04-00	Starboard, Luminus SST-10-UV-A130, 405nm	130°	405nm	3.4	930	3.14	1.85

Color	Part Number	Description	Beam Angle	Peak Wave length	Vf	Flux (mW)	uMol/s	uMol/J	uMol/s	uMol/J
					@ 350mA, Tj 25C				@700mA, Tj 85C	
 Deep Blue 450nm	LST1-01G01-RYL1-00	Starboard, Luminus SST-10-B-B130, 450nm Deep Blue	130°	450nm	3.00	600	2.26	2.15	4.01	1.83
 Green 527nm	LST1-01G01-GRN1-00	Starboard, Luminus SST-10-G-B130, 527nm Green	130°	527nm	3.40	270	1.18	0.99	2.10	0.87
 Deep Red 660nm	LST1-01G01-PRD1-00	Starboard, Luminus SST-10-DR-B130, 660nm Deep Red	130°	660nm	2.05	370	2.03	2.83	3.68	2.27
 Far Red 730nm	LST1-01G01-FRD1-00	Starboard, Luminus SST-10-FR-B130, 730nm Far Red	130°	730nm	2.10	310	1.88	2.55	3.40	2.33

All values shown above are typical.

Mechanical Dimensions

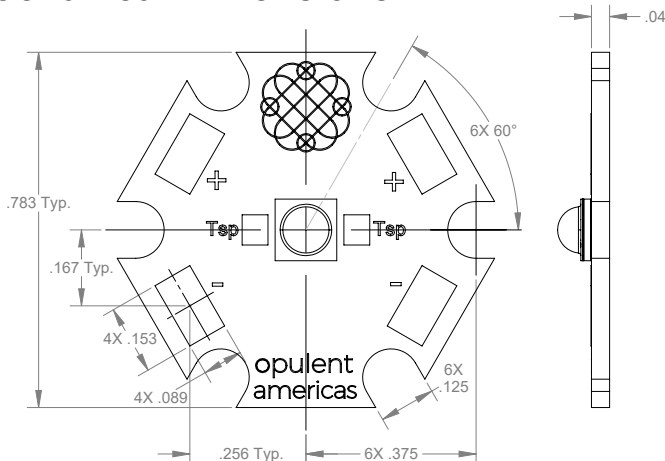

About Opulent Americas

Opulent Americas, part of Singapore based Opulent Group, is a fully integrated, global manufacturer for the lighting, automotive and medical industries. Through 30 years of manufacturing experience and state-of-the-art facilities, the company offers leading solid state lighting components and modules. The NC-based office provides quick engineering & sales support with an R&D lab to provide prototype development and custom solutions. See Opulent-Americas.com for more information.

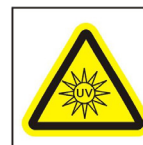

⚠ WARNING

UV LIGHT

Do not look into the light emitting from these LEDs as it is harmful to the human eye. Eye injury may result. Use skin and eye protection as necessary.

