

# APDS-9900 and APDS-9901

## Digital Proximity and Ambient Light Sensor



### Data Sheet



#### Description

The APDS-9900/9901 provides digital ambient light sensing (ALS), IR LED and a complete proximity detection system in a single 8 pin package. The proximity function offers plug and play detection to 100 mm (without front glass) thus eliminating the need for factory calibration of the end equipment or sub-assembly. The proximity detection feature operates well from bright sunlight to dark rooms. The wide dynamic range also allows for operation in short distance detection behind dark glass such as a cell phone. In addition, an internal state machine provides the ability to put the device into a low power mode in between ALS and proximity measurements providing very low average power consumption. The ALS provides a *photopic* response to light intensity in very low light condition or behind a dark faceplate.

The APDS-9900/9901 is particularly useful for display management with the purpose of extending battery life and providing optimum viewing in diverse lighting conditions. Display panel and keyboard backlighting can account for up to 30 to 40 percent of total platform power. The ALS features are ideal for use in notebook PCs, LCD monitors, flat-panel televisions, and cell phones.

The proximity function is targeted specifically towards near field proximity applications. In cell phones, the proximity detection can detect when the user positions the phone close to their ear. The device is fast enough to provide proximity information at a high repetition rate needed when answering a phone call. This provides both improved "green" power saving capability and the added security to lock the computer when the user is not present. The addition of the micro-optics lenses within the module, provide highly efficient transmission and reception of infrared energy which lowers overall power dissipation.

#### Ordering Information

Part Number	Packaging	Quantity
APDS-9900	Tape & Reel	2500 per reel
APDS-9901	Tape & Reel	2500 per reel

#### Features

ALS, IR LED and Proximity Detector in an Optical Module

- Ambient Light Sensing (ALS)
  - Approximates Human Eye Response
  - Programmable Interrupt Function with Upper and Lower Threshold
  - Up to 16-Bit Resolution
  - High Sensitivity Operates Behind Darkened Glass
  - Up to 1,000,000:1 Dynamic Range
- Proximity Detection
  - Fully Calibrated to 100 mm Detection
  - Integrated IR LED and Synchronous LED Driver
  - Eliminates "Factory Calibration" of Prox
  - Covers a 2000:1 Dynamic Range
- Programmable Wait Timer
  - Wait State Power – 70  $\mu$ A Typical
  - Programmable from 2.72 ms to > 6 Sec
- I<sup>2</sup>C Interface Compatible
  - Up to 400 kHz (I<sup>2</sup>C Fast-Mode)
  - Dedicated Interrupt Pin
- Sleep Mode Power - 2.5  $\mu$ A Typical
- Small Package L3.94 x W2.36 x H1.35 mm

#### Applications

- Cell Phone Backlight Dimming
- Cell Phone Touch-screen Disable
- Notebook/Monitor Security
- Automatic Speakerphone Enable
- Automatic Menu Pop-up
- Digital Camera Eye Sensor

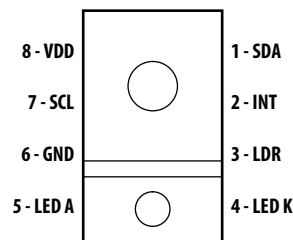

## Functional Block Diagram

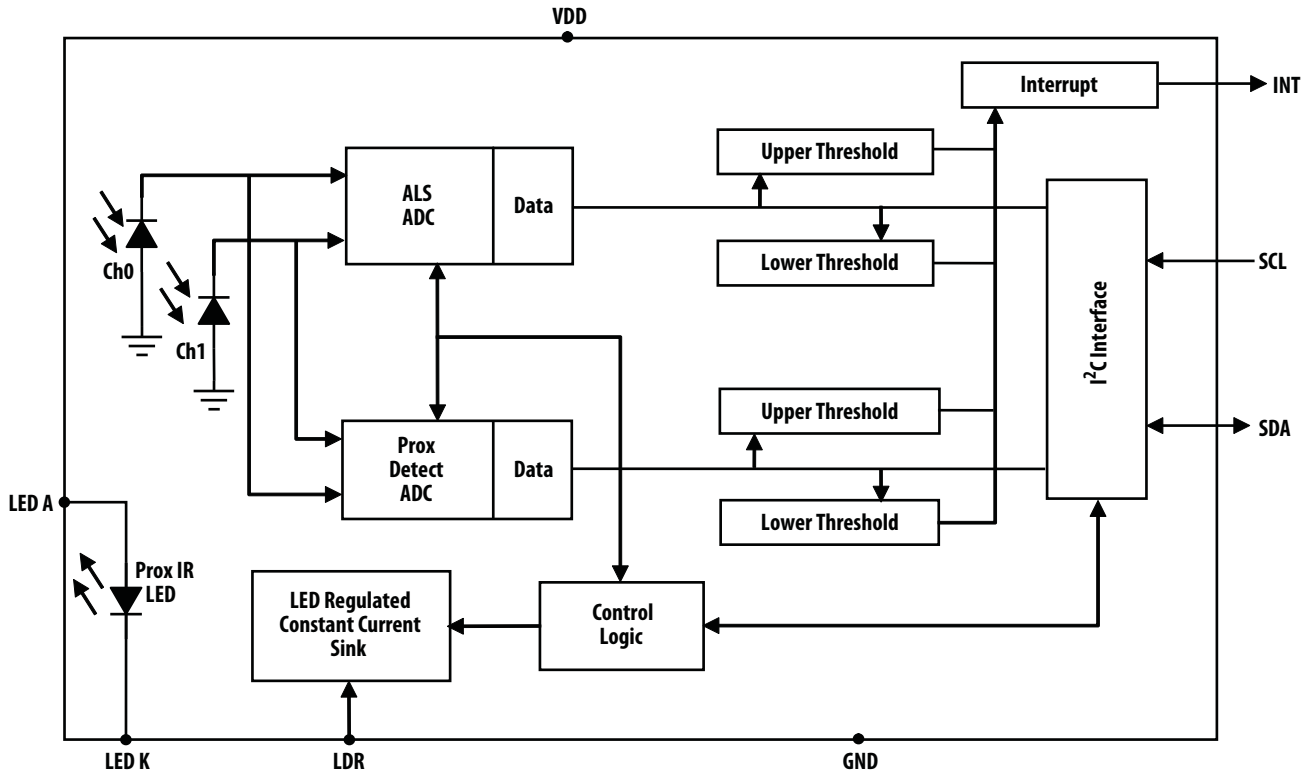

## Detailed Description

The APDS-9900/9901 light-to-digital device provides on-chip Ch0 and Ch1 diodes, integrating amplifiers, ADCs, accumulators, clocks, buffers, comparators, a state machine and an I<sup>2</sup>C interface. Each device combines one Ch0 photodiode (visible plus infrared) and one Ch1 infrared-responding (IR) photodiode. Two integrating ADCs simultaneously convert the amplified photodiode currents to a digital value providing up to 16-bits of resolution. Upon completion of the conversion cycle, the conversion result is transferred to the Ch0 and CH1 data registers. This digital output can be read by a microprocessor where the illuminance (ambient light level) in Lux is derived using an empirical formula to approximate the human eye response.

Communication to the device is accomplished through a fast (up to 400 kHz), two-wire I<sup>2</sup>C serial bus for easy connection to a microcontroller or embedded controller. The digital output of the APDS-9900/9901 device is inherently more immune to noise when compared to an analog interface.

The APDS-9900/9901 provides a separate pin for level-style interrupts. When interrupts are enabled and a pre-set value is exceeded, the interrupt pin is asserted and remains asserted until cleared by the controlling firmware.

The interrupt feature simplifies and improves system efficiency by eliminating the need to poll a sensor for a light intensity or proximity value. An interrupt is generated when the value of an ALS or proximity conversion exceeds either an upper or lower threshold. Additionally, a programmable interrupt persistence feature allows the user to determine how many consecutive exceeded thresholds are necessary to trigger an interrupt. Interrupt thresholds and persistence settings are configured independently for both ALS and proximity.

Proximity detection is fully provided with an 850 nm IR LED. An internal LED driver (LDR) pin, is jumper connected to the LED cathode (LED K) to provide a factory calibrated proximity of 100 +/- 20 mm. This is accomplished with a proprietary current calibration technique that accounts for all variances in silicon, optics, package and most importantly IR LED output power. This will eliminate or greatly reduce the need for factory calibration that is required for most discrete proximity sensor solutions. While the APDS-9900/9901 is factory calibrated at a given pulse count, the number of proximity LED pulses can be programmed from 1 to 255 pulses, which will allow greater proximity distances to be achieved. Each pulse has a 16  $\mu$ s period.

## I/O Pins Configuration

PIN	NAME	TYPE	DESCRIPTION
1	SDA	I/O	I <sup>2</sup> C serial data I/O terminal – serial data I/O for I <sup>2</sup> C.
2	INT	O	Interrupt – open drain.
3	LDR	I	LED driver for proximity emitter – up to 100 mA, open drain.
4	LEDK	O	LED Cathode, connect to LDR pin in most systems to use internal LED driver circuit
5	LEDA	I	LED Anode, connect to V <sub>BATT</sub> on PCB
6	GND		Power supply ground. All voltages are referenced to GND.
7	SCL	I	I <sup>2</sup> C serial clock input terminal – clock signal for I <sup>2</sup> C serial data.
8	V <sub>DD</sub>		Power Supply voltage.

## Absolute Maximum Ratings over operating free-air temperature range (unless otherwise noted)<sup>†</sup>

Parameter	Symbol	Min	Max	Units	Test Conditions
Power Supply voltage	V <sub>DD</sub>		3.8	V	[1]
Digital voltage range		-0.5	3.8	V	
Digital output current	I <sub>O</sub>	-1	20	mA	
Storage temperature range	T <sub>stg</sub>	-40	85	°C	

<sup>†</sup> Stresses beyond those listed under “absolute maximum ratings” may cause permanent damage to the device. These are stress ratings only and functional operation of the device at these or any other conditions beyond those indicated under “recommended operating conditions” is not implied. Exposure to absolute-maximum-rated conditions for extended periods may affect device reliability.

Note:

1. All voltages are with respect to GND.

## Recommended Operating Conditions

Parameter	Symbol	Min	Typ	Max	Units
Operating Ambient Temperature	T <sub>A</sub>	-30		85	°C
Supply voltage	V <sub>DD</sub>	2.5	3.0	3.6	V
Supply Voltage Accuracy, V <sub>DD</sub> total error including transients		-3		+3	%
LED Supply Voltage	V <sub>BATT</sub>	2.5		4.5	V

## Available Options

Part Number	Interface Description
APDS-9901	I <sup>2</sup> C VBUS = VDD Interface
APDS-9900	I <sup>2</sup> C 1.8V VBUS Interface

### Operating Characteristics, $V_{DD} = 3\text{ V}$ , $T_A = 25^\circ\text{ C}$ (unless otherwise noted)

Parameter	Symbol	Min	Typ	Max	Units	Test Conditions
Supply current [1]	$I_{DD}$		175	250	$\mu\text{A}$	Active (ATIME=0x0db, 100ms)
			70			Wait Mode
			2.5	4.0		Sleep Mode
INT SDA output low voltage	$V_{OL}$	0		0.4	V	3 mA sink current
		0		0.6		6 mA sink current
Leakage current, SDA, SCL, INT Pins	$I_{LEAK}$	-5		5	$\mu\text{A}$	
SCL, SDA input high voltage	$V_{IH}$	0.7 $V_{BUS}$ 1.25			V	APDS-9901 APDS-9900
SCL, SDA input low voltage,	$V_{IL}$			0.3 $V_{BUS}$ 0.54	V	APDS-9901 APDS-9900
Oscillator frequency	fosc	705	750	795	kHz	PON = 1

Note:

- The power consumption is raised by the programmed amount of Proximity LED Drive during the 8 us the LED pulse is on. The nominal and maximum values are shown under Proximity Characteristics. There the  $I_{DD}$  supply current is  $I_{DD}$  Active + Proximity LED Drive programmed value.

### ALS Characteristics, $V_{DD} = 3\text{ V}$ , $T_A = 25^\circ\text{ C}$ , Gain = 16, AEN = 1 (unless otherwise noted)

Parameter	Channel	Min	Typ	Max	Units	Test Conditions	
Dark ALS ADC count value	Ch0	0	1	5	counts	$E_e = 0$ , AGAIN = 120x, ATIME = 0xDB(100ms)	
	Ch1	0	1	5			
ALS ADC Integration Time Step Size		2.58	2.72	2.90	ms	ATIME = 0xff	
ALS ADC Number of Integration Steps		1		256	steps		
Full Scale ADC Counts per Step				1023	counts		
Full scale ADC count value				65535	counts	ATIME = 0xC0	
ALS ADC count value	Ch0	4000	5000	6000	counts	$\lambda_p = 640\text{ nm}$ , $E_e = 56\ \mu\text{W}/\text{cm}^2$ , ATIME = 0xF6 (27 ms), GAIN = 16x	
	Ch1		790				
	Ch0	4000	5000	6000			
	Ch1		2800				
ALS ADC count value ratio: Ch1/Ch0		10.8	15.8	20.8	%	$\lambda_p = 640\text{ nm}$ , ATIME = 0xF6 (27 ms)	
		41	56	68			$\lambda_p = 850\text{ nm}$ , ATIME = 0xF6 (27 ms)
Irradiance Responsivity: Re	Ch0		29.1		Counts per ( $\mu\text{W}/\text{cm}^2$ )	$\lambda_p = 640\text{ nm}$ , ATIME = 0xF6 (27 ms)	
	Ch1		4.6				
	Ch0		22.8				$\lambda_p = 850\text{ nm}$ , ATIME = 0xF6 (27 ms)
	Ch1		12.7				
Gain scaling, relative to 1x gain setting		-5		5	%	8x	
		-5		5		16x	
		-5		5		120x	

Notes:

- Optical measurements are made using small-angle incident radiation from light-emitting diode optical sources. Visible 640 nm LEDs and infrared 850 nm LEDs are used for final product testing for compatibility with high-volume production.
- The 640 nm irradiance  $E_e$  is supplied by an AlInGaP light-emitting diode with the following characteristics: peak wavelength = 640 nm and spectral halfwidth  $\frac{1}{2} = 17\text{ nm}$ .
- The 850 nm irradiance  $E_e$  is supplied by a GaAs light-emitting diode with the following characteristics: peak wavelength = 850 nm and spectral halfwidth  $\frac{1}{2} = 40\text{ nm}$ .
- The specified light intensity is 100% modulated by the pulse output of the device so that during the pulse output low time, the light intensity is at the specified level, and zero otherwise.

**Proximity Characteristics,  $V_{DD} = 3\text{ V}$ ,  $T_A = 25^\circ\text{ C}$ ,  $\text{PGAIN} = 1$ ,  $\text{PEN} = 1$  (unless otherwise noted)**

Parameter	Min	Typ	Max	Units	Test Conditions
$I_{DD}$ Supply current – LDR Pulse On		3		mA	
ADC Conversion Time Step Size		2.72		ms	PTIME = 0xff
ADC Number of Integration Steps		1		steps	PTIME = 0xff
Full Scale ADC Counts			1023	counts	PTIME = 0xff
Proximity IR LED Pulse Count	0		255	pulses	
Proximity Pulse Period		16.3		$\mu\text{s}$	
Proximity Pulse – LED On Time		7.2		$\mu\text{s}$	
Proximity LED Drive		100		mA	PDRIVE = 0
		50			PDRIVE = 1
		25			PDRIVE = 2
		12.5			PDRIVE = 3
Proximity ADC count value, no object		100			LED driving 8 pulses, PDRIVE = 0, open view (no glass) and no reflective object above the module.
Proximity ADC count value, 100 mm distance object	416	520	624	counts	Reflecting object – 73 mm x 83 mm Kodak 90% grey card, 100mm distance, LED driving 8 pulses, PDRIVE = 0, open view (no glass) above the module.

**IR LED Characteristics,  $V_{DD} = 3\text{ V}$ ,  $T_A = 25^\circ\text{ C}$** 

Parameter	Min	Typ	Max	Units	Test Conditions
Forward Voltage, $V_F$		1.4	1.5	V	$I_F = 20\text{ mA}$
Reverse Voltage, $V_R$	5.0			V	$I_R = 10\ \mu\text{A}$
Radiant Power, $P_O$	4.5			mW	$I_F = 20\text{ mA}$
Peak Wavelength, $\lambda_P$		850		nm	$I_F = 20\text{ mA}$
Spectrum Width, Half Power, $\Delta\lambda$		40		nm	$I_F = 20\text{ mA}$
Optical Rise Time, $T_R$		20		ns	$I_{FP} = 100\text{ mA}$
Optical Fall Time, $T_F$		20		ns	$I_{FP} = 100\text{ mA}$

**Wait Characteristics,  $V_{DD} = 3\text{ V}$ ,  $T_A = 25^\circ\text{ C}$ ,  $\text{Gain} = 16$ ,  $\text{WEN} = 1$  (unless otherwise noted)**

Parameter	Min	Typ	Max	Units	Test Conditions
Wait Step Size		2.72		ms	WTIME = 0xff
Wait Number of Step	1		256	steps	

**Characteristics of the SDA and SCL bus lines,  $V_{DD} = 3\text{ V}$ ,  $T_A = 25^\circ\text{ C}$  (unless otherwise noted)<sup>†</sup>**

Parameter	Symbol	STANDARD-MODE		FAST-MODE		Units
		Min.	Max.	Min.	Max.	
SCL clock frequency	$f_{SCL}$	0	100	0	400	kHz
Hold time (repeated) START condition. After this period, the first clock pulse is generated	$t_{HD;STA}$	4.0	–	0.6	–	$\mu\text{s}$
LOW period of the SCL clock	$t_{LOW}$	4.7	–	1.3	–	$\mu\text{s}$
HIGH period of the SCL clock	$t_{HIGH}$	4.0	–	0.6	–	$\mu\text{s}$
Set-up time for a repeated START condition	$t_{SU;STA}$	4.7	–	0.6	–	$\mu\text{s}$
Data hold time	$t_{HD;DAT}$	0	–	0	–	ns
Data set-up time	$t_{SU;DAT}$	250	–	100	–	ns
Rise time of both SDA and SCL signals	$t_r$	–	1000	–	300	ns
Fall time of both SDA and SCL signals	$t_f$	–	300	–	300	ns
Set-up time for STOP condition	$t_{SU;STO}$	4.0	–	0.6	–	$\mu\text{s}$
Bus free time between a STOP and START condition	$t_{BUF}$	4.7	–	1.3	–	$\mu\text{s}$
Capacitive load for each bus line	$C_b$	–	400	–	400	pF
Noise margin at the LOW level for each connected device (including hysteresis)	$V_{nL}$	$0.1V_{BUS}$	–	$0.1V_{BUS}$	–	V
Noise margin at the HIGH level for each connected device (including hysteresis)	$V_{nH}$	$0.2V_{BUS}$	–	$0.2V_{BUS}$	–	V

<sup>†</sup> Specified by design and characterization; not production tested.

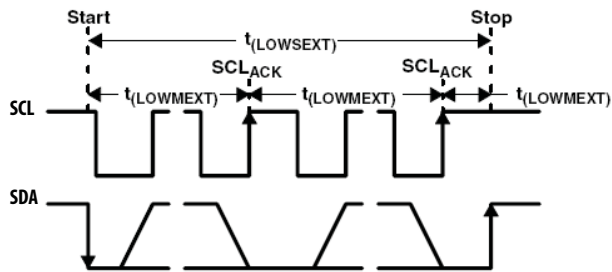
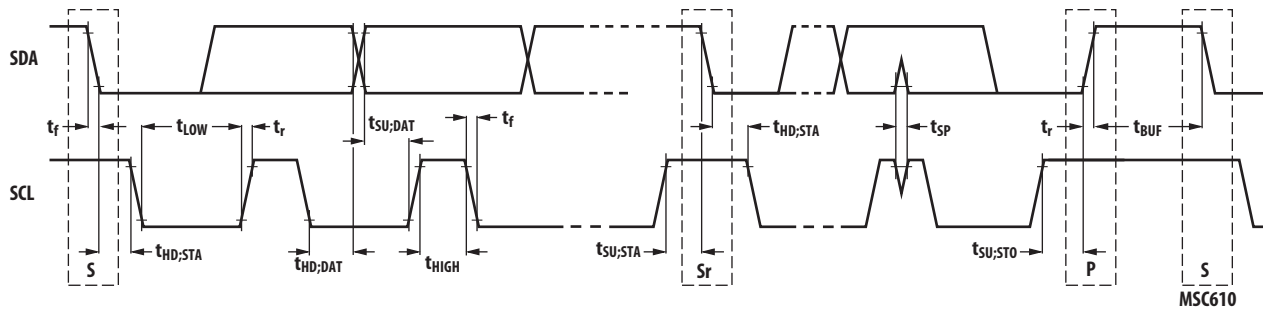

**Figure 1. I<sup>2</sup>C Bus Timing Diagram**

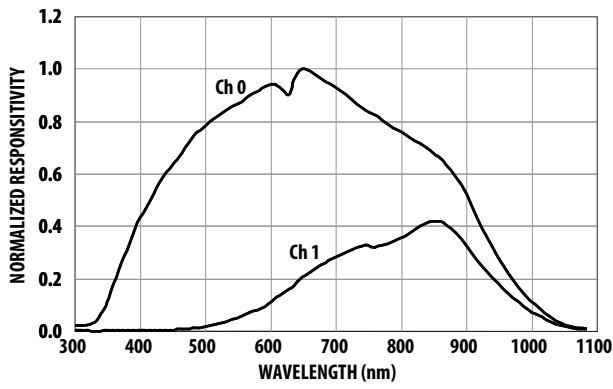

Figure 2. Spectral Response

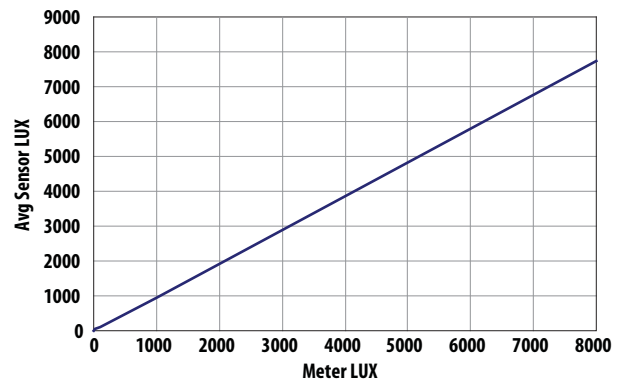

Figure 3a. ALS Sensor LUX vs. Meter LUX using Fluorescent Light

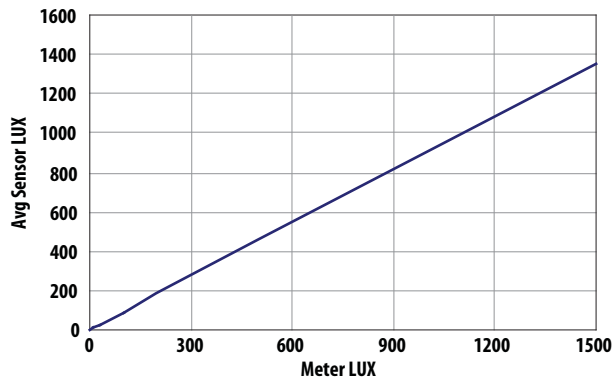

Figure 3b. ALS Sensor LUX vs. Meter LUX using Incandescent Light

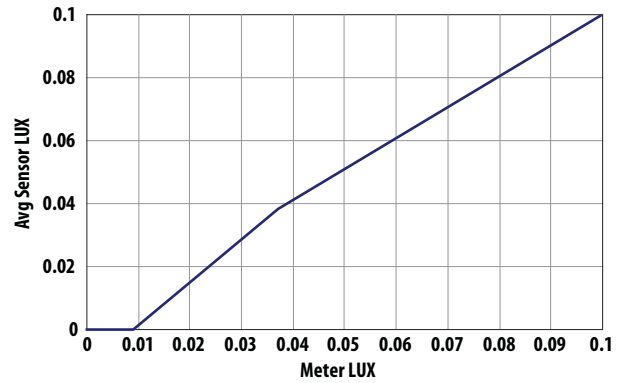

Figure 3c. ALS Sensor LUX vs. Meter LUX using Low Lux Fluorescent Light

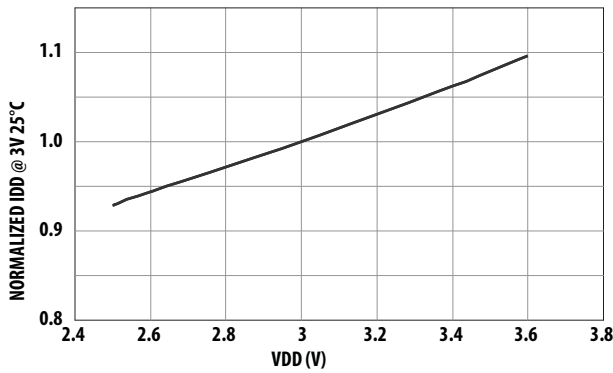

Figure 4a. Normalized IDD vs. VDD

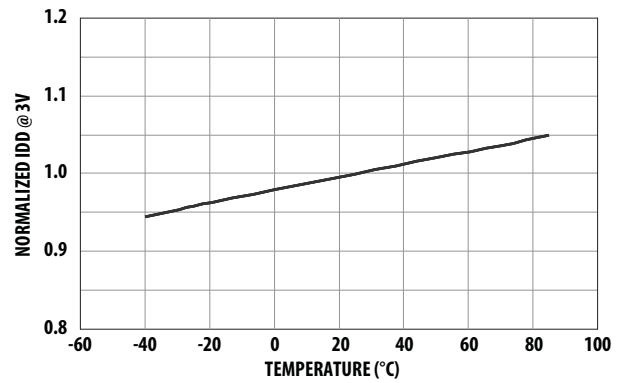

Figure 4b. Normalized IDD vs. Temperature

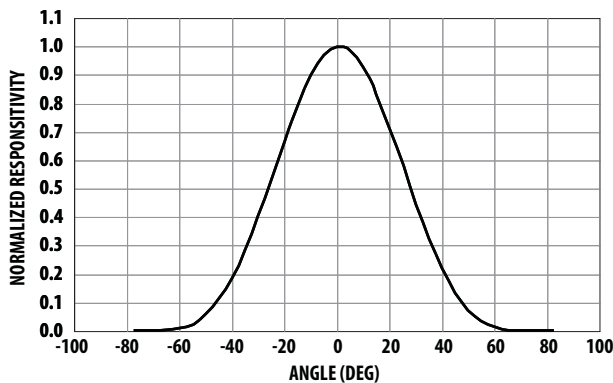

Figure 5. Normalized ALS Response vs. Angular Displacement

## PRINCIPLES OF OPERATION

### System State Machine

The APDS-9900/9901 provides control of ALS, proximity detection and power management functionality through an internal state machine. After a power-on-reset, the device is in the sleep mode. As soon as the PON bit is set, the device will move to the start state. It will then continue through the Prox, Wait and ALS states. If these states are enabled, the device will execute each function. If the PON bit is set to a 0, the state machine will continue until all conversions are completed and then go into a low power sleep mode.

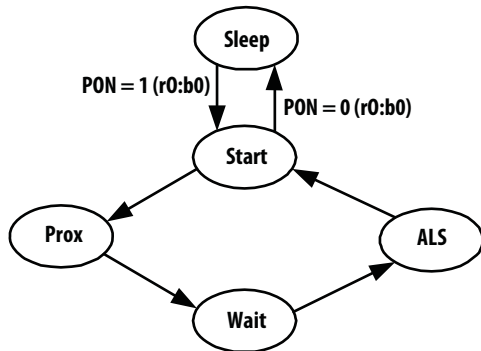

Figure 6. Simplified State Diagram

NOTE: In this document, the nomenclature uses the bit field name in *italics* followed by the register number and bit number to allow the user to easily identify the register and bit that controls the function. For example, the power on (PON) is in register 0, bit 0. This is represented as *PON (r0:b0)*.

### Ch0 and Ch1 Diodes

Conventional silicon detectors respond strongly to infrared light, which the human eye does not see. This can lead to significant error when the infrared content of the ambient light is high (such as with incandescent lighting) due to the difference between the silicon detector response and the brightness perceived by the human eye.

This problem is overcome in the APDS-9900/9901 through the use of two photodiodes. One of the photodiodes, referred to as the Ch0 channel, is sensitive to both visible and infrared light while the second photodiode is sensitive primarily to infrared light. Two integrating ADCs convert the photodiode currents to digital outputs. The CH1DATA digital value is used to compensate for the effect of the infrared component of light on the CH0DATA digital value. The ADC digital outputs from the two channels are used in a formula to obtain a value that approximates the human eye response in units of Lux.

### ALS Operation

The ALS engine contains ALS gain control (AGAIN) and two integrating analog-to-digital converters (ADC) for the Ch0 and Ch1 photodiodes. The ALS integration time (ALSIT) impacts both the resolution and the sensitivity of the ALS reading. Integration of both channels occurs simultaneously and upon completion of the conversion cycle, the results are transferred to the Ch0 and Ch1 data registers (CDATAx and IRDATAx). This data is also referred to as channel "count". The transfers are double-buffered to ensure that invalid data is not read during the transfer. After the transfer, the device automatically moves to the next state in accordance with the configured state machine.

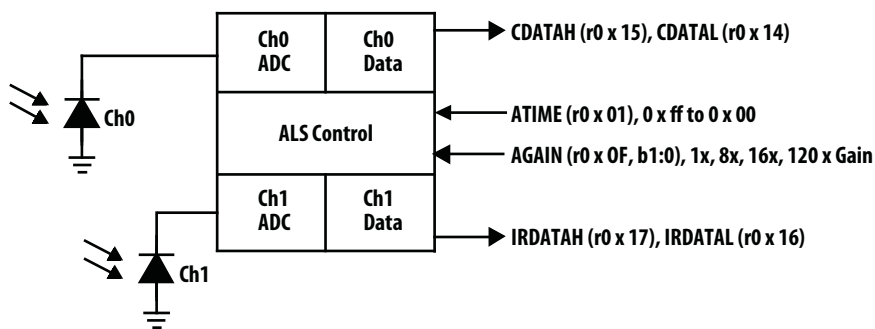

Figure 7. ALS Operation



The ALS Timing register value (ATIME) for programming the integration time (ALSIT) is a 2's complement values. The ALS Timing register value can be calculated as follows:

$$ATIME = 256 - ALSIT / 2.72 \text{ ms}$$

Inversely, the integration time can be calculated from the register value as follows:

$$ALSIT = 2.72 \text{ ms} * (256 - ATIME)$$

For example, if a 100 ms integration time is needed, the device needs to be programmed to:

$$ATIME = 256 - (100 / 2.72) = 256 - 37 = 219 = 0xDB$$

Conversely, the programmed value of 0xC0 would correspond to:

$$ALSIT = (256 - 0xC0) * 2.72 = 64 * 2.72 = 172 \text{ ms.}$$

Note: 2.72 ms can be estimated as 87 / 32. Multiply by 87 the shift by 5 bits.

### Calculating ALS Lux

Definition:

$$CH0DATA = 256 * CDATAH (r0x15) + CDATAL (r0x14)$$

$$CH1DATA = 256 * IRDATAH (r0x17) + IRDATAL (r0x16)$$

IAC = IR Adjusted Count

LPC = Lux per Count

ALSIT = ALS Integration Time (ms)

AGAIN = ALS Gain

DF = Device Factor, DF = 52 for APDS-9900/9901

GA = Glass (or Lens) Attenuation Factor

B, C, D – Coefficients

Lux Equation:

$$IAC1 = CH0DATA - B * CH1DATA$$

$$IAC2 = C * CH0DATA - D * CH1DATA$$

$$IAC = \text{Max}(IAC1, IAC2, 0)$$

$$LPC = GA * DF / (ALSIT * AGAIN)$$

$$\text{Lux} = IAC * LPC$$

Coefficients in open air:

$$GA = 0.48$$

$$B = 2.23$$

$$C = 0.7$$

$$D = 1.42$$

### Sample Lux Calculation in Open Air

Assume the following constants:

$$ALSIT = 400$$

$$AGAIN = 1$$

$$LPC = GA * DF / (ALSIT * AGAIN)$$

$$LPC = 0.48 * 52 / (400 * 1)$$

$$LPC = 0.06$$

Assume the following measurements:

$$CH0DATA = 5000$$

$$CH1DATA = 525$$

Then:

$$IAC1 = 5000 - 2.23 * 525 = 3829$$

$$IAC2 = 0.7 * 5000 - 1.42 * 525 = 2755$$

$$IAC = \text{Max}(3829, 2755, 0) = 3829$$

Lux:

$$\text{Lux} = IAC * LPC$$

$$\text{Lux} = 3829 * 0.06$$

$$\text{Lux} = 230$$

Note: please refer to application note for coefficient GA, B, C and D calculation with window.

## Recommend ALS Operations

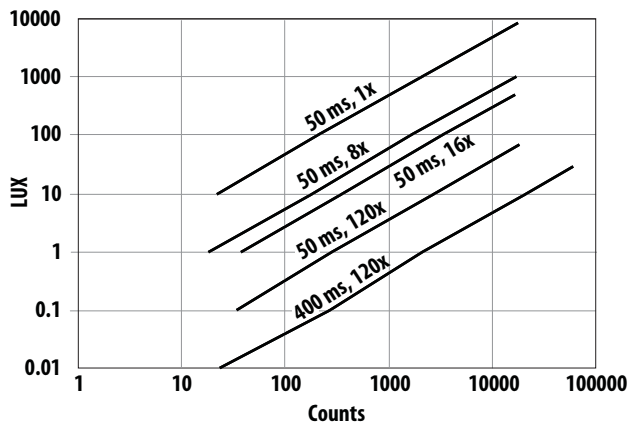

Figure 8. Gain and Integration Time to Lux without IR

With the programming versatility of the integration time and gain, it can be difficult to understand when to use the different modes. Figure 8 shows a log-log plot of the Lux vs. integration time and gain with a spectral factor of unity and no IR present.

The maximum illuminance which can be measured is ~10k Lux with no IR present. The intercept with a count of 1 shows the resolution of each setting. The Lux values in the table increase as the SF increases (spectral attenuation increases). For example, if a 10% transmissive glass is used, the Lux values would all be multiplied by 10. The Lux values in the table decrease as the IR Factor decreases. For example, with a 10% IR Factor, which corresponds to a strong incandescent light, the Lux value would need to be divided by 10.

There are many factors that will impact the decision on which value to use for integration time and gain. One of the first factors is 50/60 Hz ripple rejection for fluorescent lighting. The programmed value needs to be multiples of 10/8.3 ms or the half cycle time. Both frequencies can be rejected with a programmed value of 50 ms (ATIME = 0xED). With this value, the resolution will be 1.3 Lux per count. If higher resolution is needed, a longer integration time may be needed. In this case, the integration time should be programmed in multiples of 50.

The light level is the next determining factor for configuring device settings. Under bright conditions, the count will be fairly high. If a low light measurement is needed, a higher gain and/or longer integration time will be needed. As a general rule, it is recommended to have a Ch0 channel count of at least 10 to accurately apply the Lux equation.

The digital accumulation is limited to 16 bits, which occurs at an integration time of 173 ms. This is the maximum recommended programmed integration time before increasing the gain. (150 ms is the maximum to reduce the fluorescent ripple.)

## Proximity Detection

Proximity sensing uses an internal IR LED light source to emit light which is then viewed by the integrated light detector to measure the amount of reflected light when an object is in the light path. The amount of light detected from a reflected surface can then be used to determine an object's proximity to the sensor. The APDS-9900/9901 is factory calibrated to meet the requirement of proximity sensing of 100+/- 20 mm, thus eliminating the need for factory calibration of the end equipment. When the APDS-9900/9901 is placed behind a typical glass surface, the proximity detection achieved is around 25 to 40 mm, thus providing an ideal touch-screen disable.

The APDS-9900/9901 has controls for the number of IR pulses (PPCOUNT), the integration time (PTIME), the LED drive current (PDRIVE) and the photodiode configuration (PDIODE). At the end of the integration cycle, the results are latched into the proximity data (PDATA) register.

The LED drive current is controlled by a regulated current sink on the LDR pin. This feature eliminates the need to use a current limiting resistor to control LED current. The LED drive current can be configured for 12.5 mA, 25 mA, 50 mA, or 100 mA. For higher LED drive requirements, an external P type transistor can be used to control the LED current.

The number of LED pulses can be programmed to a value of 1 to 255 pulses as needed. Increasing the number of LED pulses at a given current will increase the sensor sensitivity. Sensitivity grows by the square root of the number of pulses. Each pulse has a 16  $\mu$ S period.

The proximity integration time (PTIME) is the period of time that the internal ADC converts the analog signal to a digital count. It is recommend that this be set to a minimum of PTIME = 0xFF or 2.72 ms.

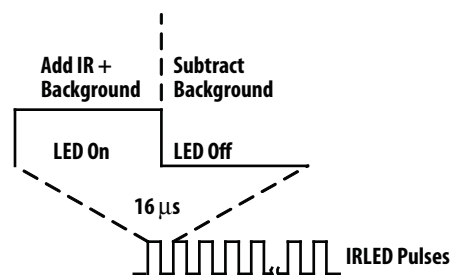

Figure 9. Proximity IR LED Waveform

## Optical Design Considerations

The APDS-9900/9901 simplifies the optical system design by eliminating the need for light pipes and improves system optical efficiency by providing apertures and package shielding which will reduce crosstalk when placed in the final system. By reducing the IR LED to glass surface crosstalk, proximity performance is greatly improved and enables a wide range of cell phone applications utilizing the APDS-9900/9901. The module package design has been optimized for minimum package foot print and short distance proximity of 100 mm typical. The spacing between the glass surface and package top surface is critical to controlling the crosstalk. If the package to top surface spacing gap, window thickness and transmittance are met, there should be no need to add additional components (such as a barrier) between the LED and photodiode. Thus with some simple mechanical design implementations, the APDS-9900/9901 will perform well in the end equipment system.

APDS-9900/9901 Module Optimized design parameters

- Window thickness,  $t \leq 1.0$  mm
- Air gap,  $g \leq 0.5$  mm
- Assuming window IR transmittance 90%

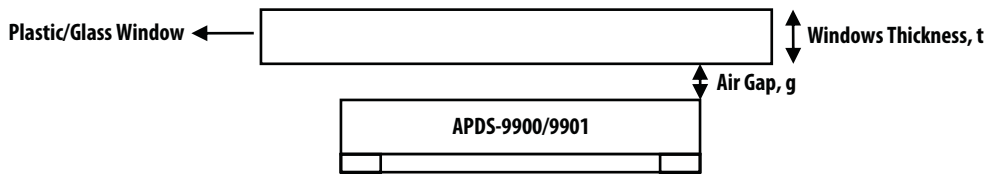

Figure 10. Proximity Detection

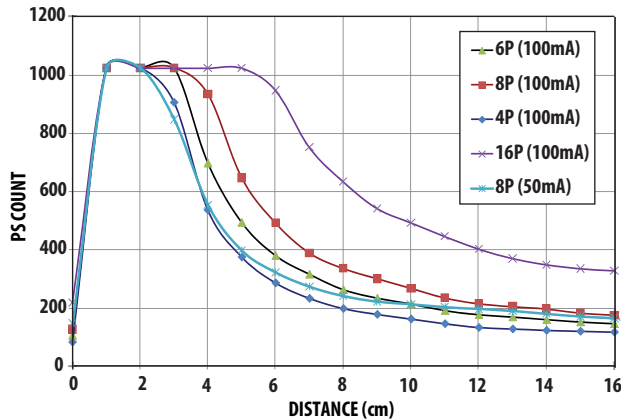

Figure 11a. PS Output vs. Distance, at Various Pulse number (LED drive Current). No glass in front of the module, 18% Kodak Grey Card.

The APDS-9900/9901 is available in a low profile package that contains optics which provides optical gain on both the LED and the sensor side of the package. The device has a package Z height of 1.35 mm and will support air gap of  $\leq 0.5$  mm between the glass and the package. The assumption of the optical system level design is that glass surface above the module is  $\leq$  to 1.0 mm.

By integrating the micro-optics in the package, the IR energy emitted can be reduced thus conserving the precious battery life in the application.

The system designer has the ability to optimize their designs for slim form factor Z height as well as improve the proximity sensing, save battery power and disable the touch screen in a cellular phone.

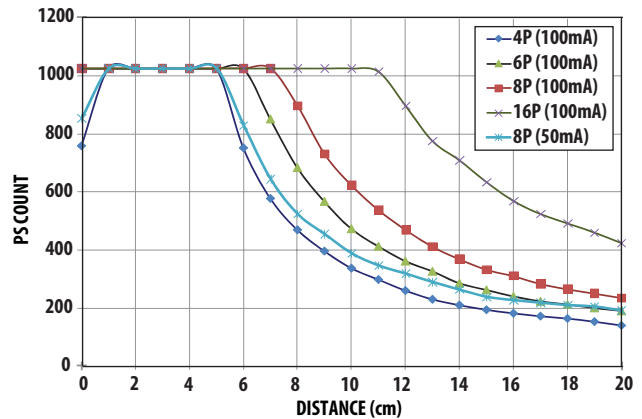

Figure 11b. PS Output vs. Distance, at Various Pulse number (LED drive Current). No glass in front of the module, 90% Kodak Grey Card.

## Interrupts

The interrupt feature of the APDS-9900/9901 simplifies and improves system efficiency by eliminating the need to poll the sensor for a light intensity or proximity value. The interrupt mode is determined by the PIEN or AIEN field in the ENABLE register.

The APDS-9900/9901 implements four 16-bit-wide interrupt threshold registers that allow the user to define thresholds above and below a desired light level. For ALS, an interrupt can be generated when the ALS Ch0 data (CDATA) exceeds the upper threshold value (AIHTx) or falls below the lower threshold (AILTx). For proximity,

an interrupt can be generated when the proximity data (PDATA) exceeds the upper threshold value (PIHTx) or falls below the lower threshold (PILTx).

To further control when an interrupt occurs, the APDS-9900/9901 provides an interrupt persistence feature. This feature allows the user to specify a number of conversion cycles for which an event exceeding the ALS interrupt threshold must persist (APERS) or the proximity interrupt threshold must persist (PPERS) before actually generating an interrupt. Refer to the register descriptions for details on the length of the persistence.

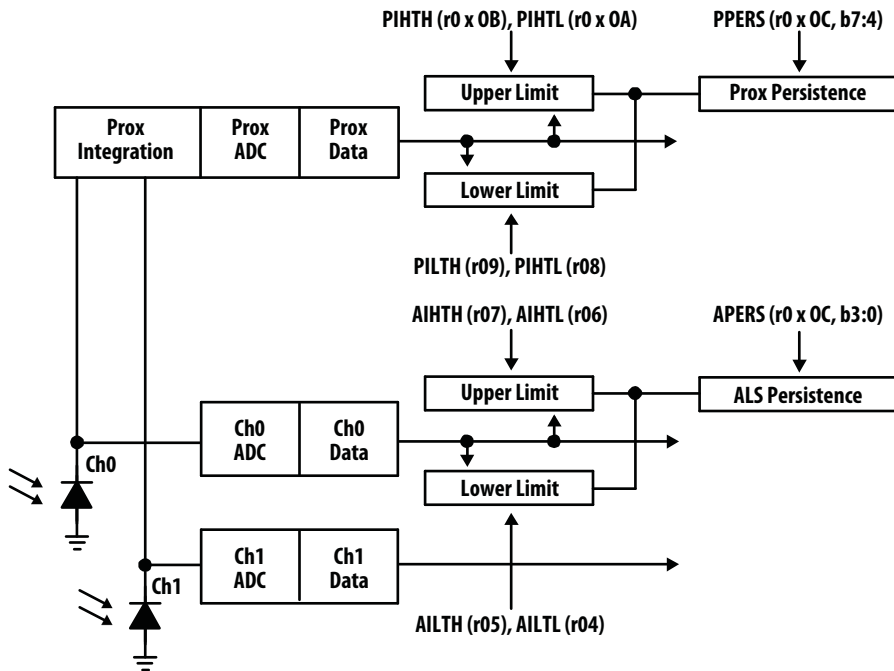

Figure 12. Programmable Interrupt

## State Diagram

The following shows a more detailed flow for the state machine. The device starts in the sleep mode. The PON bit is written to enable the device. If the PEN bit is set, the state machine will step through the proximity states of proximity accumulate and then proximity ADC conversion. As soon as the conversion is complete, the state machine will move to the following state.

If the WEN bit is set, the state machine will then cycle through the wait state. If the WLONG bit is set, the wait cycles are extended by 12x over normal operation. When the wait counter terminates, the state machine will step to the ALS state.

When the AEN bit is set, the state machine will step through the ALS states of ALS accumulate and then ALS ADC conversion. In this case, a minimum of 1 integration time step should be programmed. The ALS state machine will continue until it reaches the terminal count at which point the data will be latched in the ALS register and the interrupt set, if enabled.

## Power Management

Power consumption can be controlled through the use of the wait state timing since the wait state consumes only 70  $\mu\text{A}$  of power. The following shows an example of using the power management feature to achieve an average power consumption of 158  $\mu\text{A}$  of current with 4 – 100 mA pulses of proximity detection and 50 ms of ALS detection.

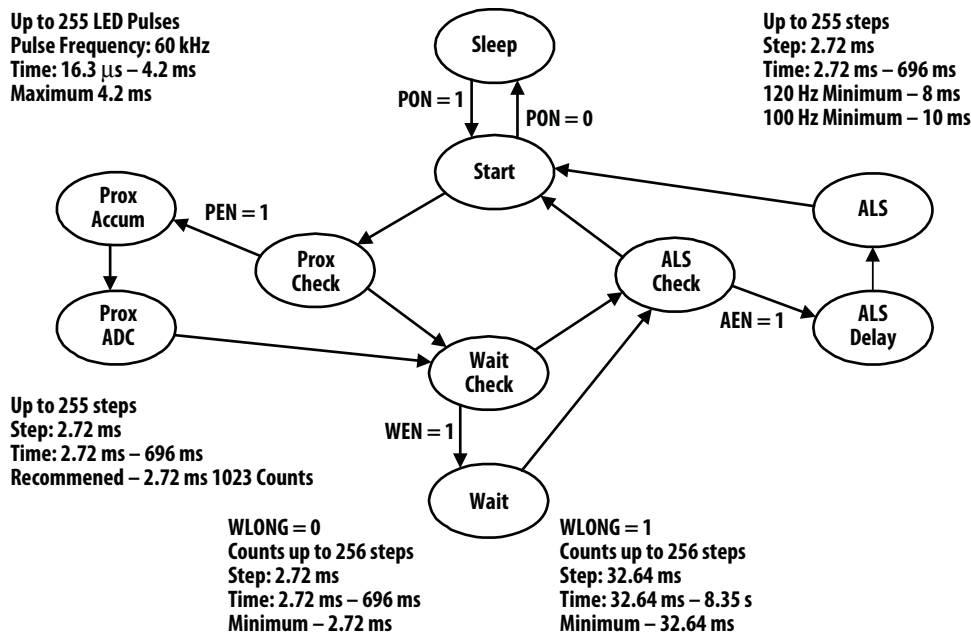

Figure 13. Extended State Diagram

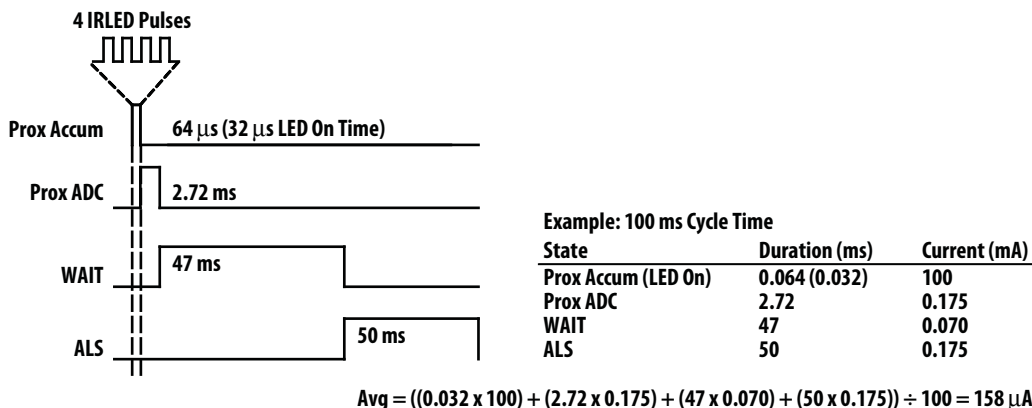

Figure 14. Power Consumption Calculations

## Basic Software Operation

The following pseudo-code shows how to do basic initialization of the APDS-9900/9901.

```
uint8 ATIME, PIME, WTIME, PPCOUNT;
ATIME = 0xff; // 2.7 ms – minimum ALS integration time
WTIME = 0xff; // 2.7 ms – minimum Wait time
PTIME = 0xff; // 2.7 ms – minimum Prox integration time
PPCOUNT = 1; // Minimum prox pulse count

WriteRegData(0, 0); //Disable and Powerdown
WriteRegData (1, ATIME);
WriteRegData (2, PTIME);
WriteRegData (3, WTIME);
WriteRegData (0xe, PPCOUNT);

uint8 PDRIVE, PDIODE, PGAIN, AGAIN;
PDRIVE = 0; //100mA of LED Power
PDIODE = 0x20; // CH1 Diode
PGAIN = 0; //1x Prox gain
AGAIN = 0; //1x ALS gain

WriteRegData (0xf, PDRIVE | PDIODE | PGAIN | AGAIN);

uint8 WEN, PEN, AEN, PON;
WEN = 8; // Enable Wait
PEN = 4; // Enable Prox
AEN = 2; // Enable ALS
PON = 1; // Enable Power On
WriteRegData (0, WEN | PEN | AEN | PON); // WriteRegData(0,0x0f);

Wait(12); //Wait for 12 ms

int CH0_data, CH1_data, Prox_data;

CH0_data = Read_Word(0x14);
CH1_data = Read_Word(0x16);
Prox_data = Read_Word(0x18);

WriteRegData(uint8 reg, uint8 data)
{
    m_I2CBus.Writel2C(0x39, 0x80 | reg, 1, &data);
}

uint16 Read_Word(uint8 reg);
{
    uint8 barr[2];
    m_I2CBus.ReadI2C(0x39, 0xA0 | reg, 2, ref barr);
    return (uint16)(barr[0] + 256 * barr[1]);
}
```

## I<sup>2</sup>C Protocol

Interface and control of the APDS-9900/9901 is accomplished through an I<sup>2</sup>C serial compatible interface (standard or fast mode) to a set of registers that provide access to device control functions and output data. The device supports a single slave address of 0x39 hex using 7 bit addressing protocol. (Contact factory for other addressing options.)

The I<sup>2</sup>C standard provides for three types of bus transaction: read, write and a combined protocol. During a write operation, the first byte written is a command byte followed by data. In a combined protocol, the first byte

written is the command byte followed by reading a series of bytes. If a read command is issued, the register address from the previous command will be used for data access. Likewise, if the MSB of the command is not set, the device will write a series of bytes at the address stored in the last valid command with a register address. The command byte contains either control information or a 5 bit register address. The control commands can also be used to clear interrupts. For a complete description of I<sup>2</sup>C protocols, please review the I<sup>2</sup>C Specification at: <http://www.NXP.com>

### Start and Stop conditions

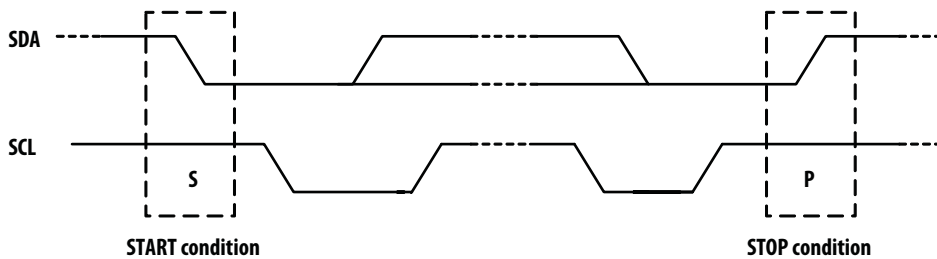

### Data transfer on I<sup>2</sup>C-bus

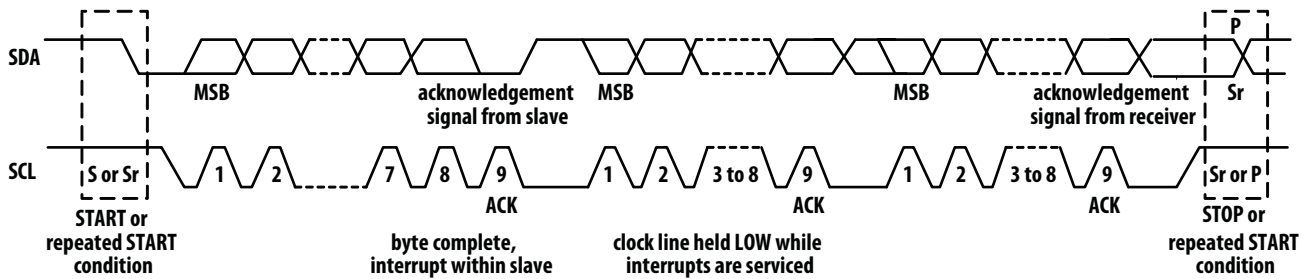

### A complete data transfer

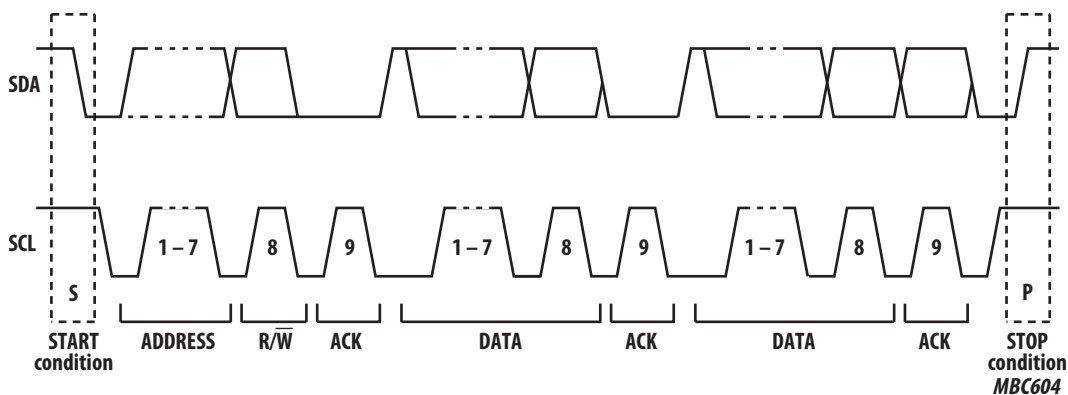

- A Acknowledge (0)
- N Not Acknowledged (1)
- P Stop Condition
- R Read (1)
- S Start Condition
- Sr Repeated Start Condition
- W Write (0)
- ... Continuation of protocol
- Master-to-Slave
- Slave-to-Master

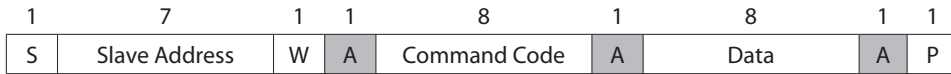

**I<sup>2</sup>C Write Protocol**

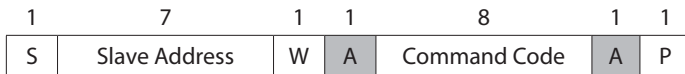

**I<sup>2</sup>C Write Protocol (Clear Interrupt)**

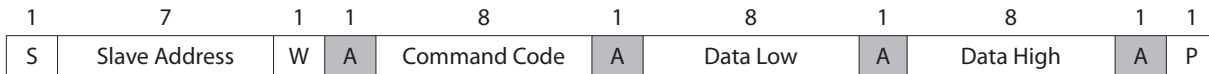

**I<sup>2</sup>C Write Word Protocol**

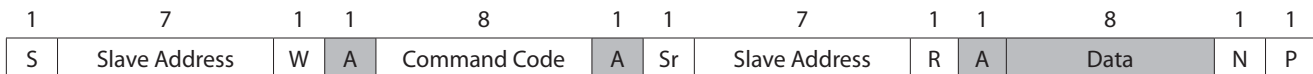

**I<sup>2</sup>C Read Protocol – Combined Format**

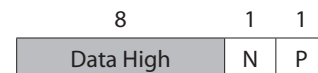
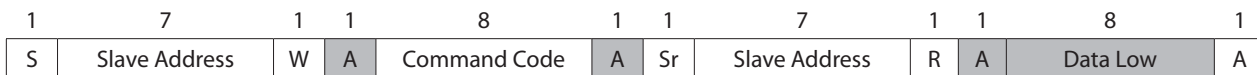

**I<sup>2</sup>C Read Word Protocol**



## Register Set

The APDS-9900/9901 is controlled and monitored by data registers and a command register accessed through the serial interface. These registers provide for a variety of control functions and can be read to determine results of the ADC conversions.

ADDRESS	RESISTER NAME	R/W	REGISTER FUNCTION	Reset Value
–	COMMAND	W	Specifies register address	0x00
0x00	ENABLE	R/W	Enable of states and interrupts	0x00
0x01	ATIME	R/W	ALS ADC time	0x00
0x02	PTIME	R/W	Proximity ADC time	0xFF
0x03	WTIME	R/W	Wait time	0xFF
0x04	AILTL	R/W	ALS interrupt low threshold low byte	0x00
0x05	AILTH	R/W	ALS interrupt low threshold hi byte	0x00
0x06	AIHTL	R/W	ALS interrupt hi threshold low byte	0x00
0x07	AIHTL	R/W	ALS interrupt hi threshold hi byte	0x00
0x08	PILTL	R/W	Proximity interrupt low threshold low byte	0x00
0x09	PILTH	R/W	Proximity interrupt low threshold hi byte	0x00
0x0A	PIHTL	R/W	Proximity interrupt hi threshold low byte	0x00
0x0B	PIHTH	R/W	Proximity interrupt hi threshold hi byte	0x00
0x0C	PERS	R/W	Interrupt persistence filters	0x00
0x0D	CONFIG	R/W	Configuration	0x00
0x0E	PPCOUNT	R/W	Proximity pulse count	0x00
0x0F	CONTROL	R/W	Gain control register	0x00
0x11	REV	R	Revision Number	Rev
0x12	ID	R	Device ID	ID
0x13	STATUS	R	Device status	0x00
0x14	CDATAL	R	Ch0 ADC low data register	0x00
0x15	CDATAH	R	Ch0 ADC high data register	0x00
0x16	IRDATA1	R	Ch1 ADC low data register	0x00
0x17	IRDATAH	R	Ch1 ADC high data register	0x00
0x18	PDATA1	R	Proximity ADC low data register	0x00
0x19	PDATAH	R	Proximity ADC high data register	0x00

The mechanics of accessing a specific register depends on the specific protocol used. See the section on I<sup>2</sup>C protocols on the previous pages. In general, the COMMAND register is written first to specify the specific control/status register for following read/write operations.

## Command Register

The command registers specifies the address of the target register for future write and read operations.

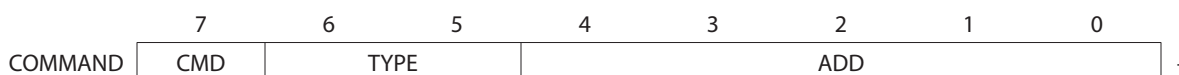

FIELD	BITS	DESCRIPTION												
COMMAND	7	Select Command Register. Must write as 1 when addressing COMMAND register.												
TYPE	6:5	Selects type of transaction to follow in subsequent data transfers:												
		<table border="1"> <thead> <tr> <th>FIELD VALUE</th> <th>INTEGRATION TIME</th> </tr> </thead> <tbody> <tr> <td>00</td> <td>Repeated Byte protocol transaction</td> </tr> <tr> <td>01</td> <td>Auto-Increment protocol transaction</td> </tr> <tr> <td>10</td> <td>Reserved – Do not use</td> </tr> <tr> <td>11</td> <td>Special function – See description below</td> </tr> </tbody> </table> <p>Byte protocol will repeatedly read the same register with each data access. Block protocol will provide auto-increment function to read successive bytes.</p>	FIELD VALUE	INTEGRATION TIME	00	Repeated Byte protocol transaction	01	Auto-Increment protocol transaction	10	Reserved – Do not use	11	Special function – See description below		
FIELD VALUE	INTEGRATION TIME													
00	Repeated Byte protocol transaction													
01	Auto-Increment protocol transaction													
10	Reserved – Do not use													
11	Special function – See description below													
ADD	4:0	Address register/special function register. Depending on the transaction type, see above, this field either specifies a special function command or selects the specific control-status-register for following write or read transactions:												
		<table border="1"> <thead> <tr> <th>FIELD VALUE</th> <th>READ VALUE</th> </tr> </thead> <tbody> <tr> <td>00000</td> <td>Normal – no action</td> </tr> <tr> <td>00101</td> <td>Proximity interrupt clear</td> </tr> <tr> <td>00110</td> <td>ALS interrupt clear</td> </tr> <tr> <td>00111</td> <td>Proximity and ALS interrupt clear</td> </tr> <tr> <td>other</td> <td>Reserved – Do not write</td> </tr> </tbody> </table> <p>ALS/Proximity Interrupt Clear. Clears any pending ALS/Proximity interrupt. This special function is self clearing.</p>	FIELD VALUE	READ VALUE	00000	Normal – no action	00101	Proximity interrupt clear	00110	ALS interrupt clear	00111	Proximity and ALS interrupt clear	other	Reserved – Do not write
FIELD VALUE	READ VALUE													
00000	Normal – no action													
00101	Proximity interrupt clear													
00110	ALS interrupt clear													
00111	Proximity and ALS interrupt clear													
other	Reserved – Do not write													

## Enable Register (0x00)

The ENABLE register is used primarily to power the APDS-9900/9901 device up and down as shown in Table 4.



FIELD	BITS	DESCRIPTION
Reserved	7:6	Reserved. Write as 0.
PIEN	5	Proximity Interrupt Enable. When asserted, permits proximity interrupts to be generated.
AIEN	4	ALS Interrupt Enable. When asserted, permits ALS interrupt to be generated.
WEN	3	Wait Enable. This bit activates the wait feature. Writing a 1 activates the wait timer. Writing a 0 disables the wait timer.
PEN	2	Proximity Enable. This bit activates the proximity function. Writing a 1 enables proximity. Writing a 0 disables proximity.
AEN	1	ALS Enable. This bit activates the two channel ADC. Writing a 1 activates the ADC. Writing a 0 disables the ADC.
PON	0	Power ON. This bit activates the internal oscillator to permit the timers and ADC channels to operate. Writing a 1 activates the oscillator. Writing a 0 disables the oscillator.

Notes:

1. A 2.72 ms delay is automatically inserted prior to entering the ADC cycle, independent of the WEN bit.
2. Both AEN and PON must be asserted before the ADC channels will operate correctly.
3. During writes and reads over the I<sup>2</sup>C interface, this bit is overridden and the oscillator is enabled, independent of the state of PON.
4. A minimum interval of 2.72 ms must pass after PON is asserted before either proximity or an ALS can be initiated. This required time is enforced by the hardware in cases where the firmware does not provide it.

## ALS Timing Register (0x01)

The ALS timing register controls the integration time of the ALS Ch0 and Ch1 channel ADCs in 2.72 ms increments.

FIELD	BITS	DESCRIPTION			
ATIME	7:0	VALUE	CYCLES	TIME (ALSIT)	Max Count
		0xff	1	2.72 ms	1023
		0xf6	10	27.2 ms	10239
		0xdb	37	100.64 ms	37887
		0xc0	64	174.08 ms	65535
0x00	256	696.32 ms	65535		

## Proximity Time Control Register (0x02)

The proximity timing register controls the integration time of the proximity ADC in 2.72 ms increments. It is recommended that this register be programmed to a value of 0xff (1 cycle, 1023 bits).

FIELD	BITS	DESCRIPTION			
PTIME	7:0	VALUE	CYCLES	TIME	Max Count
		0xff	1	2.72 ms	1023

## Wait Time Register (0x03)

Wait time is set 2.72 ms increments unless the WLONG bit is asserted in which case the wait times are 12x longer. WTIME is programmed as a 2's complement number.

FIELD	BITS	DESCRIPTION			
WTIME	7:0	REGISTER VALUE	WALL TIME	TIME (WLONG = 0)	TIME (WLONG = 1)
		0xff	1	2.72 ms	0.032 sec
		0xb6	74	201.29 ms	2.37 sec
		0x00	256	696.32 ms	8.19 sec

Notes:

1. The Write Byte protocol cannot be used when WTIME is greater than 127.
2. The Proximity Wait Time Register should be configured before PEN and/or AEN is/are asserted.

## ALS Interrupt Threshold Register (0x04 – 0x07)

The ALS interrupt threshold registers provides the values to be used as the high and low trigger points for the comparison function for interrupt generation. If the value generated by the ALS channel crosses below the low threshold specified, or above the higher threshold, an interrupt is asserted on the interrupt pin.

REGISTER	ADDRESS	BITS	DESCRIPTION
AILTL	0x04	7:0	ALS Ch0 channel low threshold lower byte
AILTH	0x05	7:0	ALS Ch0 channel low threshold upper byte
AIHTL	0x06	7:0	ALS Ch0 channel high threshold lower byte
AIHTH	0x07	7:0	ALS Ch0 channel high threshold upper byte

Note: The Write Word protocol should be used to write byte-paired registers.

## Proximity Interrupt Threshold Register (0x08 – 0x0B)

The proximity interrupt threshold registers provide the values to be used as the high and low trigger points for the comparison function for interrupt generation. If the value generated by proximity channel crosses below the lower threshold specified, or above the higher threshold, an interrupt is signaled to the host processor.

REGISTER	ADDRESS	BITS	DESCRIPTION
PILTL	0x08	7:0	Proximity ADC channel low threshold lower byte
PILTH	0x09	7:0	Proximity ADC channel low threshold upper byte
PIHTL	0x0A	7:0	Proximity ADC channel high threshold lower byte
PIHTH	0x0B	7:0	Proximity ADC channel high threshold upper byte

## Persistence Register (0x0C)

The persistence register controls the filtering interrupt capabilities of the device. Configurable filtering is provided to allow interrupts to be generated after each ADC integration cycle or if the ADC integration has produced a result that is outside of the values specified by threshold register for some specified amount of time. Separate filtering is provided for proximity and ALS functions.

ALS interrupts are generated by looking only at the ADC integration results of channel 0.



FIELD	BITS	DESCRIPTION
PPERS	7:4	Proximity interrupt persistence. Controls rate of proximity interrupt to the host processor.
		<b>FIELD VALUE</b> <b>MEANING</b> <b>INTERRUPT PERSISTENCE FUNCTION</b>
		0000      Every      Every proximity cycle generates an interrupt
		0001      1      1 consecutive proximity values out of range
		...      ...      ...
1111      15      15 consecutive proximity values out of range		
APERS	3:0	Interrupt persistence. Controls rate of interrupt to the host processor.
		<b>FIELD VALUE</b> <b>MEANING</b> <b>INTERRUPT PERSISTENCE FUNCTION</b>
		0000      Every      Every ALS cycle generates an interrupt
		0001      1      1 consecutive Ch0 channel values out of range
		0010      2      2 consecutive Ch0 channel values out of range
		0011      3      3 consecutive Ch0 channel values out of range
		0100      5      5 consecutive Ch0 channel values out of range
		0101      10      10 consecutive Ch0 channel values out of range
		0110      15      15 consecutive Ch0 channel values out of range
		0111      20      20 consecutive Ch0 channel values out of range
		1000      25      25 consecutive Ch0 channel values out of range
		1001      30      30 consecutive Ch0 channel values out of range
		1010      35      35 consecutive Ch0 channel values out of range
		1011      40      40 consecutive Ch0 channel values out of range
		1100      45      45 consecutive Ch0 channel values out of range
		1101      50      50 consecutive Ch0 channel values out of range
		1110      55      55 consecutive Ch0 channel values out of range
1111      60      60 consecutive Ch0 channel values out of range		

### Configuration Register (0x0D)

The configuration register sets the wait long time.

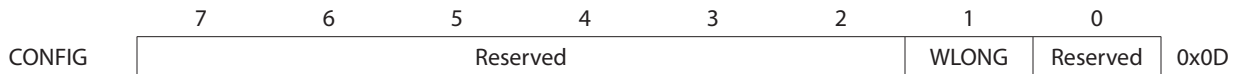

FIELD	BITS	DESCRIPTION
Reserved	7:2	Reserved. Write as 0.
WLONG	1	Wait Long. When asserted, the wait cycles are increased by a factor 12x from that programmed in the WTIME register.
Reserved	0	Reserved. Write as 0.

### Proximity Pulse Count Register (0x0E)

The proximity pulse count register sets the number of proximity pulses that will be transmitted. When proximity detection is enabled, a proximity detect cycle occurs after each ALS cycle. PPCOUNT defines the number of pulses to be transmitted at a 62.5 kHz rate.

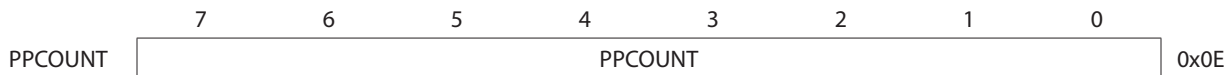

FIELD	BITS	DESCRIPTION
PPCOUNT	7:0	Proximity Pulse Count. Specifies the number of proximity pulses to be generated.

## Control Register (0x0F)

The Gain register provides eight bits of miscellaneous control to the analog block. These bits typically control functions such as gain settings and/or diode selection.



FIELD	BITS	DESCRIPTION										
PDRIVE	7:6	LED Drive Strength.										
		<table style="width: 100%; border-collapse: collapse;"> <thead> <tr> <th style="text-align: left;">FIELD VALUE</th> <th style="text-align: left;">LED STRENGTH</th> </tr> </thead> <tbody> <tr> <td>00</td> <td>100 mA</td> </tr> <tr> <td>01</td> <td>50 mA</td> </tr> <tr> <td>10</td> <td>25 mA</td> </tr> <tr> <td>11</td> <td>12.5 mA</td> </tr> </tbody> </table>	FIELD VALUE	LED STRENGTH	00	100 mA	01	50 mA	10	25 mA	11	12.5 mA
FIELD VALUE	LED STRENGTH											
00	100 mA											
01	50 mA											
10	25 mA											
11	12.5 mA											
PDIODE	5:4	Proximity Diode Select.										
		<table style="width: 100%; border-collapse: collapse;"> <thead> <tr> <th style="text-align: left;">FIELD VALUE</th> <th style="text-align: left;">DIODE SELECTION</th> </tr> </thead> <tbody> <tr> <td>00</td> <td>Reserved</td> </tr> <tr> <td>01</td> <td>Reserved</td> </tr> <tr> <td>10</td> <td>Proximity uses the Ch1 diode</td> </tr> <tr> <td>11</td> <td>Reserved</td> </tr> </tbody> </table>	FIELD VALUE	DIODE SELECTION	00	Reserved	01	Reserved	10	Proximity uses the Ch1 diode	11	Reserved
FIELD VALUE	DIODE SELECTION											
00	Reserved											
01	Reserved											
10	Proximity uses the Ch1 diode											
11	Reserved											
PGAIN	3:2	Proximity Gain Control.										
		<table style="width: 100%; border-collapse: collapse;"> <thead> <tr> <th style="text-align: left;">FIELD VALUE</th> <th style="text-align: left;">Proximity GAIN VALUE</th> </tr> </thead> <tbody> <tr> <td>00</td> <td>1X Gain</td> </tr> <tr> <td>01</td> <td>Reserved</td> </tr> <tr> <td>10</td> <td>Reserved</td> </tr> <tr> <td>11</td> <td>Reserved</td> </tr> </tbody> </table>	FIELD VALUE	Proximity GAIN VALUE	00	1X Gain	01	Reserved	10	Reserved	11	Reserved
FIELD VALUE	Proximity GAIN VALUE											
00	1X Gain											
01	Reserved											
10	Reserved											
11	Reserved											
AGAIN	1:0	ALS Gain Control.										
		<table style="width: 100%; border-collapse: collapse;"> <thead> <tr> <th style="text-align: left;">FIELD VALUE</th> <th style="text-align: left;">ALS GAIN VALUE</th> </tr> </thead> <tbody> <tr> <td>00</td> <td>1X Gain</td> </tr> <tr> <td>01</td> <td>8X Gain</td> </tr> <tr> <td>10</td> <td>16X Gain</td> </tr> <tr> <td>11</td> <td>120X Gain</td> </tr> </tbody> </table>	FIELD VALUE	ALS GAIN VALUE	00	1X Gain	01	8X Gain	10	16X Gain	11	120X Gain
FIELD VALUE	ALS GAIN VALUE											
00	1X Gain											
01	8X Gain											
10	16X Gain											
11	120X Gain											

## Revision number Register (0x11)

The Revision number register provides the silicon revision number. The Rev ID is a read-only register whose value never changes.

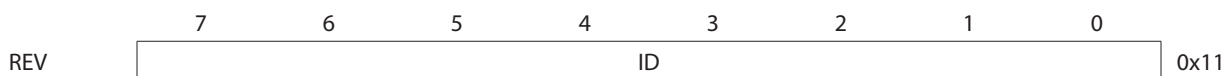

FIELD	BITS	DESCRIPTION
REV	7:0	Revision number identification
		0x01

## Device ID Register (0x12)

The ID register provides the value for the part number. The ID register is a read-only register.

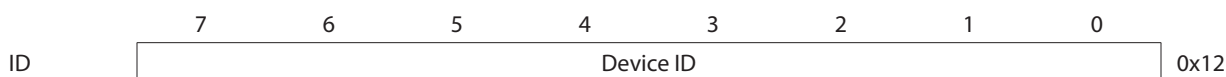

FIELD	BITS	DESCRIPTION
ID	7:0	Part number identification 0x29 = APDS-9900 0x20 = APDS-9901

## Status Register (0x13)

The Status Register provides the internal status of the device. This register is read only.



FIELD	BITS	DESCRIPTION
Reserved	7:6	Reserved. Write as 0.
PINT	5	Proximity Interrupt. Indicates that the device is asserting a proximity interrupt.
AINT	4	ALS Interrupt. Indicates that the device is asserting an ALS interrupt.
Reserved	3:2	Reserved. Write as 0.
PVALID	1	PS Valid. Indicates that the PS has completed an integration cycle.
AVALID	0	ALS Valid. Indicates that the ALS Ch0/Ch1 channels have completed an integration cycle.

## ALS Data Registers (0x14 – 0x17)

ALS Ch0 and CH1 data are stored as two 16-bit values. To ensure the data is read correctly, a two byte read I<sup>2</sup>C transaction should be utilized with a read word protocol bit set in the command register. With this operation, when the lower byte register is read, the upper eight bits are stored into a shadow register, which is read by a subsequent read to the upper byte. The upper register will read the correct value even if additional ADC integration cycles end between the reading of the lower and upper registers.

REGISTER	ADDRESS	BITS	DESCRIPTION
CDATA	0x14	7:0	ALS Ch0 channel data low byte
CDATAH	0x15	7:0	ALS Ch0 channel data high byte
IRDATA	0x16	7:0	ALS Ch1 channel data low byte
IRDATAH	0x17	7:0	ALS Ch1 channel data high byte

## Proximity DATA Register (0x18 – 0x19)

Proximity data is stored as a 16-bit value. To ensure the data is read correctly, a two byte read I<sup>2</sup>C transaction should be utilized with a read word protocol bit set in the command register. With this operation, when the lower byte register is read, the upper eight bits are stored into a shadow register, which is read by a subsequent read to the upper byte. The upper register will read the correct value even if additional ADC integration cycles end between the reading of the lower and upper registers.

REGISTER	ADDRESS	BITS	DESCRIPTION
PDATA	0x18	7:0	Proximity data low byte
PDATAH	0x19	7:0	Proximity data high byte

## Application Information: Hardware

The application hardware circuit for using implementing an ALS and Proximity system solution is quite simple with the APDS-9900/9901 and is shown in following figure. The  $1\ \mu\text{F}$  decoupling capacitors should be low ESR to reduce noise. It further recommended to maximize system performance the use of power and ground planes is recommended in the PCB. If mounted on a flexible circuit, the power and ground traces back to the PCB should be sufficiently wide enough to have a low resistance, such as  $< 1\ \text{ohm}$ .

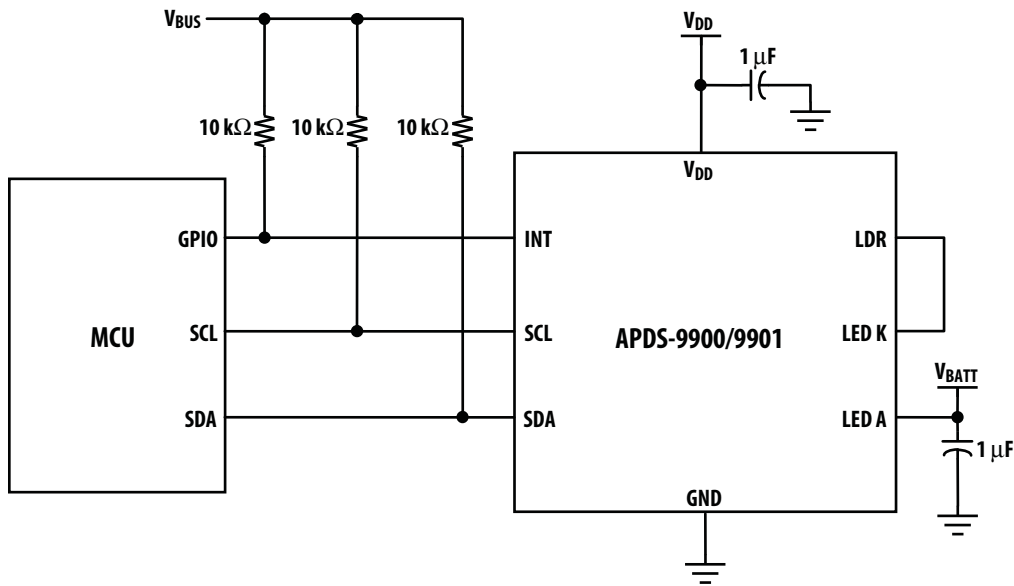
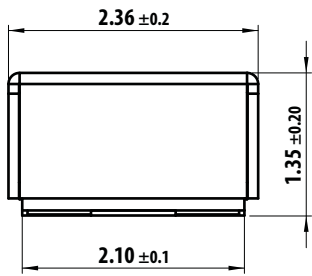
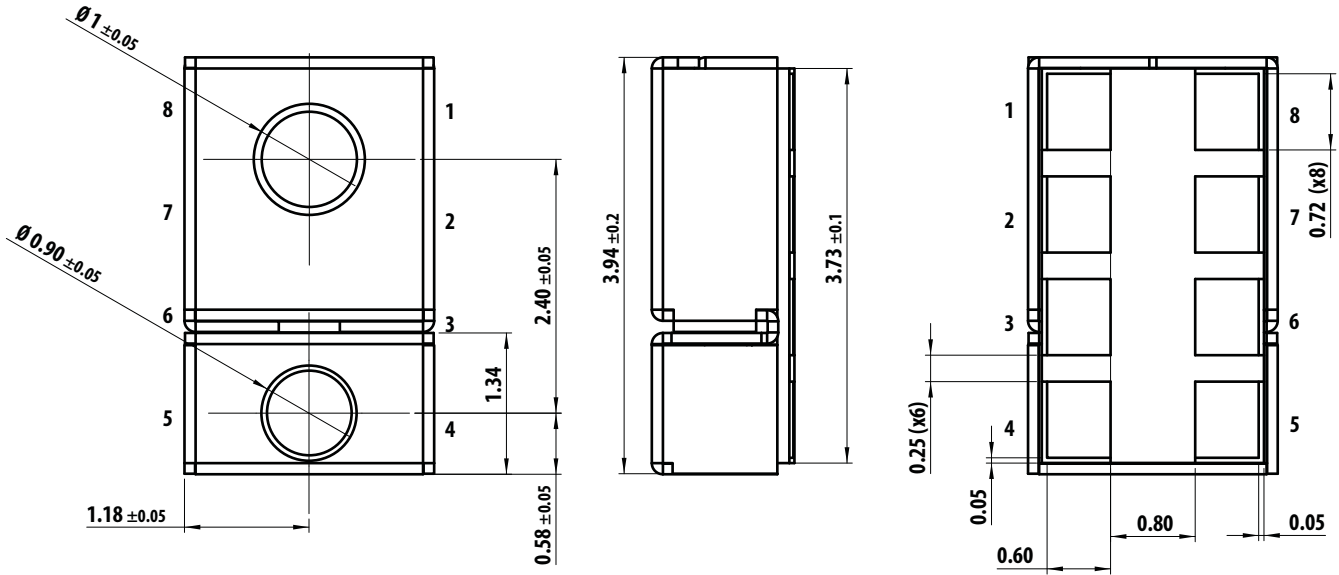

Figure 15. Circuit implementation for ALS plus Proximity solution using the APDS-9900/9901



## Package Outline Dimensions



- PINOUT**
- 1 - SDA
  - 2 - INT
  - 3 - LDR
  - 4 - LEDK
  - 5 - LEDA
  - 6 - GND
  - 7 - SCL
  - 8 - VDD

## PCB Pad Layout

Suggested PCB pad layout guidelines for the Dual Flat No-Lead surface mount package are shown below.

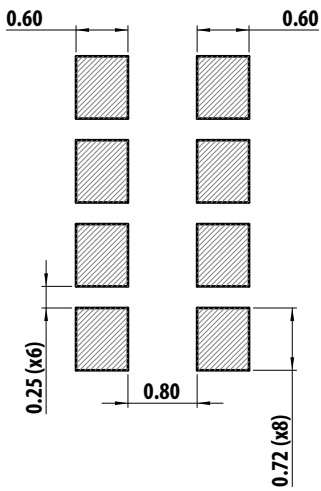

Notes: all linear dimensions are in mm.

## Tape Dimensions

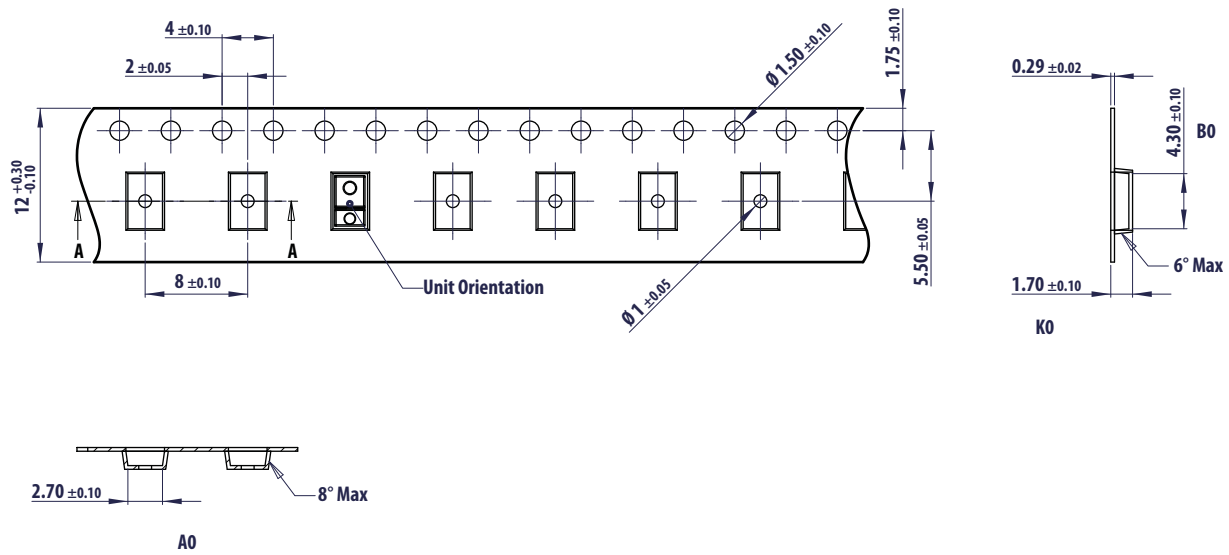

All dimensions unit: mm

## Reel Dimensions

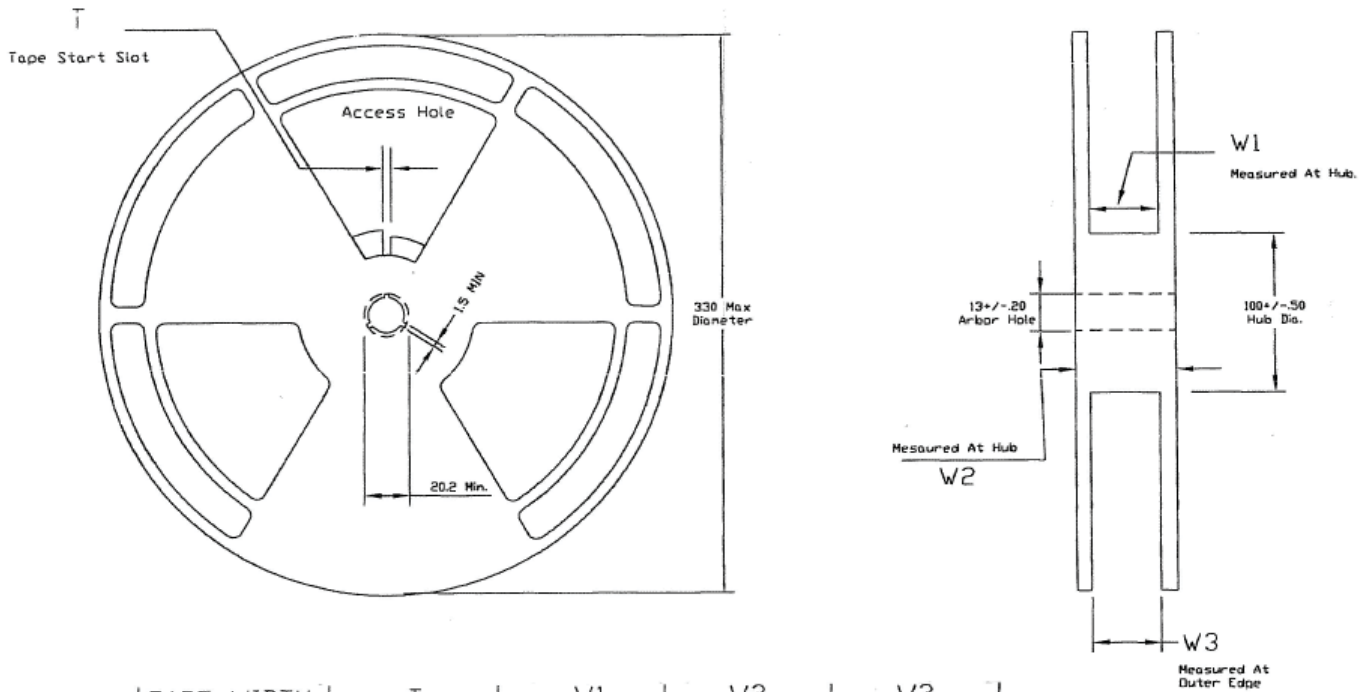

TAPE WIDTH	T	W1	W2	W3
12MM	$4 \pm .50$	$12.4 \pm 2.0$ $-0.0$	18.4 MAX	11.9MIN 15.4MAX

## Moisture Proof Packaging

All APDS-9900/9901 options are shipped in moisture proof package. Once opened, moisture absorption begins. This part is compliant to JEDEC MSL 3.

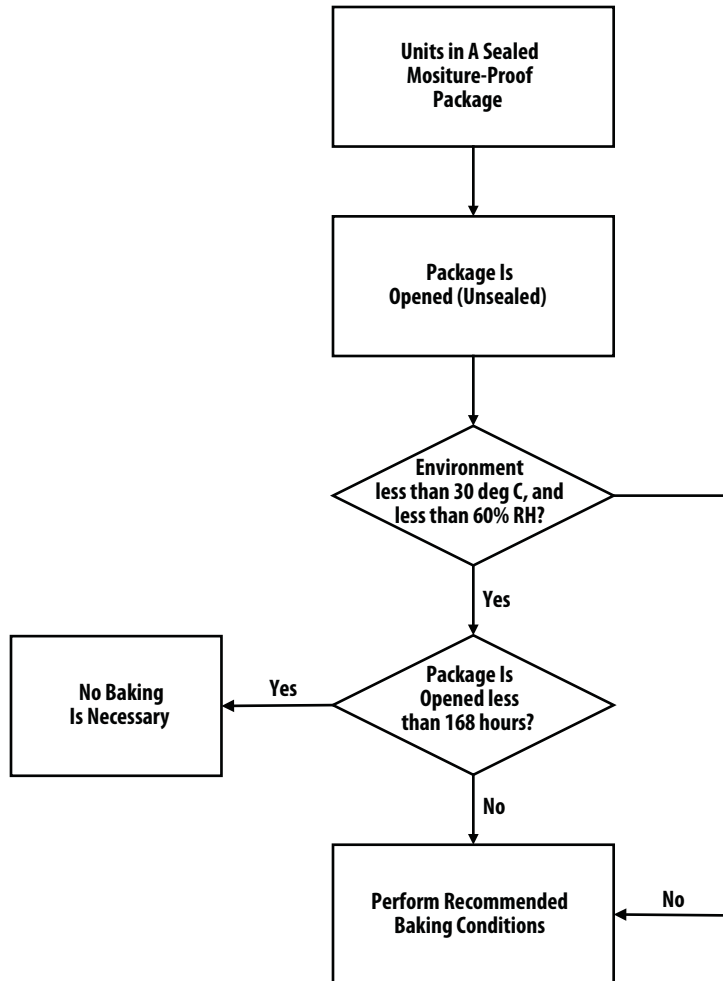

### Baking Conditions:

Package	Temperature	Time
In Reel	60° C	48 hours
In Bulk	100° C	4 hours

If the parts are not stored in dry conditions, they must be baked before reflow to prevent damage to the parts.

Baking should only be done once.

### Recommended Storage Conditions:

Storage Temperature	10° C to 30° C
Relative Humidity	below 60% RH

### Time from unsealing to soldering:

After removal from the bag, the parts should be soldered within 168 hours if stored at the recommended storage conditions. If times longer than 168 hours are needed, the parts must be stored in a dry box

## Recommended Reflow Profile

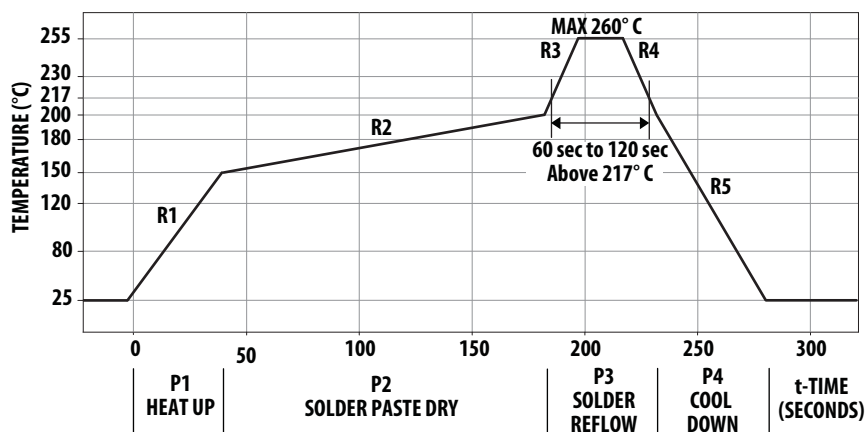

Process Zone	Symbol	$\Delta T$	Maximum $\Delta T/\Delta \text{time}$ or Duration
Heat Up	P1, R1	25° C to 150° C	3° C/s
Solder Paste Dry	P2, R2	150° C to 200° C	100 s to 180s
Solder Reflow	P3, R3	200° C to 260° C	3° C/s
	P3, R4	260° C to 200° C	-6° C/s
Cool Down	P4, R5	200° C to 25° C	-6° C/s
Time maintained above liquidus point, 217° C	> 217° C		60 s to 120 s
Peak Temperature		260° C	-
Time within 5° C of actual Peak Temperature		> 255° C	20 s to 40 s
Time 25° C to Peak Temperature		25° C to 260° C	8 mins

The reflow profile is a straight-line representation of a nominal temperature profile for a convective reflow solder process. The temperature profile is divided into four process zones, each with different  $\Delta T/\Delta \text{time}$  temperature change rates or duration. The  $\Delta T/\Delta \text{time}$  rates or duration are detailed in the above table. The temperatures are measured at the component to printed circuit board connections.

In process zone P1, the PC board and component pins are heated to a temperature of 150° C to activate the flux in the solder paste. The temperature ramp up rate, R1, is limited to 3° C per second to allow for even heating of both the PC board and component pins.

Process zone P2 should be of sufficient time duration (100 to 180 seconds) to dry the solder paste. The temperature is raised to a level just below the liquidus point of the solder.

Process zone P3 is the solder reflow zone. In zone P3, the temperature is quickly raised above the liquidus point of

solder to 260° C (500° F) for optimum results. The dwell time above the liquidus point of solder should be between 60 and 120 seconds. This is to assure proper coalescing of the solder paste into liquid solder and the formation of good solder connections. Beyond the recommended dwell time the intermetallic growth within the solder connections becomes excessive, resulting in the formation of weak and unreliable connections. The temperature is then rapidly reduced to a point below the solidus temperature of the solder to allow the solder within the connections to freeze solid.

Process zone P4 is the cool down after solder freeze. The cool down rate, R5, from the liquidus point of the solder to 25° C (77° F) should not exceed 6° C per second maximum. This limitation is necessary to allow the PC board and component pins to change dimensions evenly, putting minimal stresses on the component.

It is recommended to perform reflow soldering no more than twice.

For product information and a complete list of distributors, please go to our web site: [www.avagotech.com](http://www.avagotech.com)