

Fiber-Optic Sensing Heads Offer a Wide Variety of Unique Solutions for Tough Problems

- Fiber-optic sensors detect small, fast-moving objects in space-confined installations and harsh environments
- For a custom fit in the field, most plastic filament cables can be cut to length
- For detection in hard-to-reach places, sensing heads with bendable stainless steel tubing retain complex shapes
- Coiled and ultra-flexible cables are ideal for flexing and reciprocating machinery such as robots
- Side-view sensing heads or accessories save space in right-angle detection
- Convergent beam sensing heads allow accurate positioning and background suppression even for shiny objects
- Narrow detection zone of concentric beam sensing heads helps eliminate background objects and gives consistent sensing, regardless of object direction
- Highly flexible fibers with minimum 1-mm bending radius allows cable to conform to machine contours
- Most fiber cables offer IP67 protection and temperature ratings of -40°C to 70°C (-40°F to 158°F)

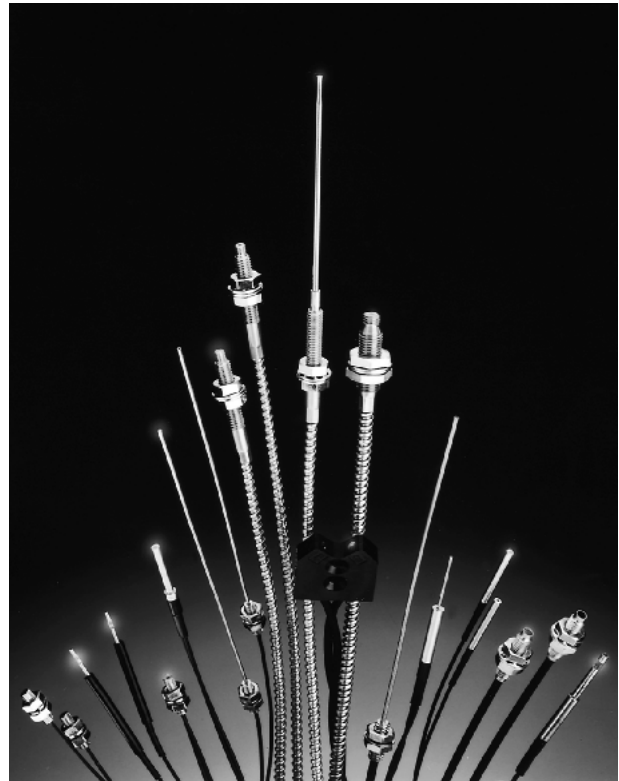

■ FIBER-OPTIC CABLE AND AMPLIFIER COMPATIBILITY

| Fiber cables Part number | DIN-rail mounting amplifiers | | | | | | | Block style amplifiers | | | |
|--|------------------------------|---------|-------|---------------|--------|----------------|-----------------|------------------------|---------------|-------------------|------------------|
| | E3X-A | E3X-DAN | E3X-F | E3X-H, -NH | E3X-NM | E3X-NT, -NV | E3X- NVG,-VG | E3MC- MY | E3XA- CC4A | E3JU-XR E3JU-X | E3A2-X E3S-X3 |
| Through-beam, General Purpose Type | | | | | | | | | | | |
| E32-T11 | OK | OK | OK | OK | OK | OK | OK | -- | -- | OK (-XR) | -- |
| E32-T11L | OK | OK | OK | OK | OK | OK | OK | OK | -- | -- | -- |
| E32-T11R | OK | OK | -- | OK | OK | OK | -- | -- | -- | -- | -- |
| E32-T12L | OK | OK | OK | OK | OK | OK | OK | -- | -- | -- | -- |
| E32-T17L | OK | OK | OK | OK | OK | OK | OK | OK | -- | -- | -- |
| E32-T21 | OK | OK | OK | OK | OK | OK | OK | -- | -- | OK (-XR) | -- |
| E32-T21L | OK | OK | OK | OK | OK | OK | OK | -- | -- | -- | -- |
| E32-T21R | OK | OK | -- | OK | OK | OK | -- | -- | -- | -- | -- |
| E32-T22 | OK | OK | OK | OK | OK | OK | OK | -- | -- | OK (-XR) | -- |
| E32-T22L | OK | OK | OK | OK | OK | OK | OK | -- | -- | -- | -- |
| E32-TC50 | OK | -- | OK | OK (-H) | -- | -- | OK (-VG) | -- | -- | -- | -- |
| E32-TC200 | OK | OK | OK | OK | OK | OK | OK | OK | OK | OK (-XR) | OK |
| E32-TC200A | OK | OK | OK | OK | OK | OK | OK | -- | OK | -- | OK |
| E32-TC200C | OK | -- | OK | OK | OK | OK | OK | -- | -- | -- | OK |
| E32-TC200E | OK | OK | OK | OK | OK | OK | OK | -- | OK | - | OK |
| E32-TC500 | OK | -- | OK | OK (-H) | -- | -- | OK (-VG) | -- | -- | -- | -- |
| E32-TC1000 | OK | -- | OK | OK (-H) | -- | -- | OK (-VG) | -- | -- | -- | -- |
| Through-beam, Armored Type | | | | | | | | | | | |
| E32-UTAT13F | OK | -- | -- | -- | -- | -- | -- | -- | -- | OK (-XR) | -- |
| E32-UTAT16F | OK | -- | -- | -- | -- | -- | -- | -- | -- | OK (-XR) | -- |
| E32-UTBT13F | -- | -- | -- | -- | -- | -- | -- | -- | -- | OK (-X) | -- |
| E32-UTBT16F | -- | -- | -- | -- | -- | -- | -- | -- | -- | OK (-X) | -- |
| Through-beam, Probe Type | | | | | | | | | | | |
| E32-T33-1 | OK | -- | OK | OK (-H) | -- | -- | OK (-VG) | -- | -- | -- | -- |
| E32-TC200B | OK | OK | OK | OK | OK | OK | OK | -- | OK | -- | OK |
| E32-TC200B4 | OK | OK | OK | OK | OK | OK | OK | -- | OK | -- | -- |
| E32-TC200D | OK | -- | OK | OK | -- | -- | OK (-VG) | -- | -- | -- | OK |
| E32-TC200D4 | OK | -- | OK | OK | -- | -- | OK (-VG) | -- | -- | -- | -- |
| E32-TC200F | OK | OK | OK | OK | OK | OK | OK | -- | OK | -- | OK |
| E32-TC200F4 | OK | OK | OK | OK | OK | OK | OK | -- | OK | -- | -- |
| Through-beam, Side Sensing Type | | | | | | | | | | | |
| E32-T14 | OK | OK | OK | OK | OK | OK | OK | -- | OK | -- | -- |
| E32-T14L | OK | OK | OK | OK | OK | OK | OK | -- | -- | -- | -- |
| E32-T16 | OK | OK | OK | OK | OK | OK | OK | OK | OK | -- | -- |
| E32-T16P | OK | OK | -- | OK (-NH) | OK | OK | -- | -- | OK | -- | -- |
| E32-T24 | OK | OK | OK | OK | OK | OK | OK | -- | -- | -- | -- |
| Through-beam, High Temperature Type | | | | | | | | | | | |
| E32-T51 | OK | OK | OK | OK | OK | OK | OK | -- | -- | OK (-XR) | -- |
| E32-T61 | OK | OK | OK | OK | OK | OK | OK | -- | -- | -- | -- |
| Through-beam, Special Purpose Type | | | | | | | | | | | |
| E32-G14 | OK | OK | OK | OK | OK | OK | OK | -- | OK | -- | -- |
| E32-M21 | OK | OK | OK | OK | OK | OK | OK | -- | OK | -- | -- |
| E32-T12F | OK | OK | OK | OK | OK | OK | OK | -- | -- | -- | -- |
| E32-T22S | -- | OK | -- | OK | OK | OK | -- | -- | -- | -- | -- |
| E32-T24S | -- | OK | -- | OK | OK | OK | -- | -- | -- | -- | -- |
| E32-T84S | -- | OK | -- | OK (-NH) | OK | OK | -- | -- | -- | -- | -- |

| Fiber cables | DIN-rail mounting amplifiers | | | | | | | Block style amplifiers | | | |
|--|------------------------------|-------|---------|----------|---------------|--------|----------------|------------------------|-------------|---------------|-------------------|
| | Part number | E3X-A | E3X-DAN | E3X-F | E3X-H, -NH | E3X-NM | E3X-NT, -NV | E3X- NVG,-VG | E3MC- MY | E3XA- CC4A | E3JU-XR E3JU-X |
| Diffuse, General Purpose Type | | | | | | | | | | | |
| E32-CC200 | OK | OK | OK | OK | OK | OK | OK | OK | OK | -- | OK |
| E32-D11 | OK | OK | OK | OK | OK | OK | OK | -- | -- | OK (-XR) | -- |
| E32-D11L | OK | OK | OK | OK | OK | OK | OK | OK | -- | -- | -- |
| E32-D11R | OK | OK | -- | OK (-NH) | OK | OK | OK | -- | -- | -- | -- |
| E32-D21 | OK | OK | OK | OK | OK | OK | OK | -- | -- | OK (-XR) | -- |
| E32-D21L | OK | OK | OK | OK | OK | OK | OK | -- | -- | -- | -- |
| E32-D21R | OK | OK | -- | OK (-NH) | OK | OK | -- | -- | -- | -- | -- |
| E32-D22L | OK | OK | OK | OK | OK | OK | OK | -- | -- | -- | -- |
| E32-D32 | OK | OK | OK | OK | OK | OK | OK | -- | -- | OK (-XR) | -- |
| E32-D32L | OK | OK | OK | OK | OK | OK | OK | OK | -- | -- | -- |
| E32-DC50 | OK | -- | OK | OK (-H) | -- | -- | OK (-VG) | -- | -- | -- | -- |
| E32-DC200 | OK | OK | OK | OK | OK | OK | OK | OK | OK | OK (-XR) | OK |
| E32-DC200C | OK | -- | OK | OK | OK | OK | OK | -- | -- | -- | OK |
| E32-DC200E | OK | OK | OK | OK | OK | OK | OK | -- | OK | -- | OK |
| E32-DC500 | OK | -- | OK | OK (-H) | -- | -- | OK (-VG) | -- | -- | -- | -- |
| E32-DC1000 | OK | -- | OK | OK (-H) | -- | -- | OK (-VG) | -- | -- | -- | -- |
| Diffuse, Armored Type | | | | | | | | | | | |
| E32-UDAT13F | OK | -- | -- | -- | -- | -- | -- | -- | -- | OK (-XR) | -- |
| E32-UDAT16F | OK | -- | -- | -- | -- | -- | -- | -- | -- | OK (-XR) | -- |
| E32-UDBT13F | -- | -- | -- | -- | -- | -- | -- | -- | -- | OK (-X) | -- |
| E32-UDBT16F | -- | -- | -- | -- | -- | -- | -- | -- | -- | OK (-X) | -- |
| Diffuse, Probe Type | | | | | | | | | | | |
| E32-D33 | OK | OK | OK | OK | OK | OK | -- | -- | OK | -- | -- |
| E32-DC200B | OK | OK | OK | OK | OK | OK | OK | -- | OK | -- | OK |
| E32-DC200B4 | OK | OK | OK | OK | OK | OK | OK | -- | -- | -- | OK |
| E32-DC200D | OK | -- | OK | OK | -- | -- | OK (-VG) | -- | -- | -- | OK |
| E32-DC200D4 | OK | -- | OK | OK | -- | -- | OK (-VG) | -- | -- | -- | -- |
| E32-DC200F | OK | OK | OK | OK | OK | OK | OK | -- | OK | -- | OK |
| E32-DC200F4 | OK | OK | OK | OK | OK | OK | OK | -- | OK | -- | OK |
| E32-DC9G | OK | -- | OK | OK | -- | -- | OK (-VG) | -- | OK | -- | -- |
| E32-DC9G4 | OK | -- | OK | OK | -- | -- | OK (-VG) | -- | -- | -- | -- |
| Diffuse, Side Sensing Type | | | | | | | | | | | |
| E32-D14L | OK | OK | OK | OK | OK | OK | OK | -- | -- | -- | -- |
| E32-D24 | OK | OK | OK | OK | OK | OK | OK | -- | -- | -- | -- |
| Diffuse, High Temperature Type | | | | | | | | | | | |
| E32-D51 | OK | OK | OK | OK | OK | OK | OK | -- | -- | OK (-XR) | -- |
| E32-D61 | OK | OK | OK | OK | OK | OK | OK | -- | -- | -- | -- |
| E32-D73 | OK | OK | OK | OK | OK | OK | OK | -- | -- | -- | -- |
| Diffuse, Convergent and Special Purpose Types | | | | | | | | | | | |
| E32-D12F | OK | OK | OK | OK | OK | OK | OK | -- | -- | -- | -- |
| E32-L24L | OK | OK | OK | OK | OK | OK | -- | -- | -- | -- | -- |
| E32-L25 | OK | OK | OK | OK | OK | OK | -- | -- | -- | -- | -- |
| E32-L25A | OK | OK | OK | OK | OK | OK | -- | -- | -- | -- | -- |
| E32-L25L | OK | OK | OK | OK | OK | OK | -- | -- | -- | -- | -- |
| Retroreflective Type | | | | | | | | | | | |
| E32-R16 | OK | OK | OK | OK | OK | OK | -- | -- | -- | -- | -- |
| E32-R21 | OK | OK | OK | OK | OK | OK | -- | -- | OK | -- | -- |

Ordering Information

Omron offers fiber-optic cables in through-beam, diffuse and retroreflective types. Each cable has a different sensing distance depending on the amplifier selected. The ordering information provides the sensing distance and compatibility with two general classes of amplifiers: DIN rail-mounting DC amplifiers and block style amplifiers with different attributes, such as AC/DC supply

voltage, analog output and color sensing.

 indicates models that customers can cut to length for their application. Models without this mark are pre-cut by the factory to maintain their respective specifications.

■ E3X-SERIES, DIN RAIL-MOUNTING AMPLIFIERS

The table specifies the sensing characteristics of each fiber when used with the following amplifiers:

Legend:

A E3X-A (General purpose amplifier)

DAN-HS E3X-DAN (Digital amplifier- high speed mode)

DAN-LD E3X-DAN (Digital amplifier- long distance mode)

DAN-SM E3X-DAN (Digital amplifier- standard distance mode)

F E3X-F (High performance amplifier- high speed)

H E3X-H11 (High gain amplifier)

NM E3X-NM (4 channel auto-tuning amplifier)

NT E3X-NT (Auto-tuning amplifier: general purpose)

NH E3X-NH (High-precision, auto-tuning amplifier)





NHB E3X-NHB (High-precision, blue LED, auto-tuning amp)

NV E3X-NV21 (Water-resistant, red light source amplifier)

NVG E3X-NVG21 (Water-resistant, green light source amp)

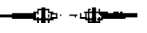
VG E3X-VG (Mark sensing amplifier)

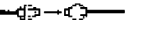
■ THROUGH-BEAM, GENERAL PURPOSE TYPE

| Application | Features | Appearance | Type | Detection distance | Min. detectable object (opaque) | Part number |
|----------------------------|---|--|--------|--------------------|---------------------------------|---|
| Flexible, resists breaking | Ideal for mounting on moving sections 4 mm bending radius |  M4 threaded head x 11.7 mm (0.46 in) L 2 m (6.56 ft) length | A | 180 (1,000*) mm | 0.2 mm dia. | E32-T11  |
| | | | DAN-HS | 250 (1,300*) mm | ----- | |
| | | | DAN-LD | 850 (4,000**) mm | ----- | |
| | | | DAN-SM | 680 (3,600*) mm | 0.01 mm dia. | |
| | | | F | 80 (400*) mm | 0.2 mm dia. | |
| | | | H | 360 (2,000*) mm | 0.3 mm dia. | |
| | | | NH | 360 (2,000*) mm | 0.04 mm dia. | |
| | | | NHB | 50 mm | 0.04 mm dia. | |
| | | | NM | 240 (1,300*) mm | 0.2 mm dia. | |
| | | | NT | 260 (1,400*) mm | 0.1 mm dia. | |
| | | | NV | 260 (1,400*) mm | 0.1 mm dia. | |
| | | | NVG | 10 (120*) mm | 0.2 mm dia. | |
| VG | 10 (120*) mm | 0.2 mm dia. | | | | |
| Long distance | Compact M4, head, 1.4 mm ID fiber; 25 mm bending radius |  M4 threaded head x 11 mm (0.43 in) L 2 m (6.56 ft) length | A | 350 (1,000*) mm | 0.5 mm dia. | E32-T11L  |
| | | | DAN-HS | 490 (1,200*) mm | ----- | |
| | | | DAN-LD | 1,660 (4,000**) mm | ----- | |
| | | | DAN-SM | 1,330 (3,200*) mm | 0.02 mm dia. | |
| | | | F | 150 (550*) mm | 0.5 mm dia. | |
| | | | H | 700 (2,000*) mm | 0.5 mm dia. | |
| | | | NH | 700 (2,000*) mm | 0.06 mm dia. | |
| | | | NHB | 90 (250*) mm | 0.06 mm dia. | |
| | | | NM | 500 (1,200*) mm | 0.2 mm dia. | |
| | | | NT | 540 (1,280*) mm | 0.15 mm dia. | |
| | | | NV | 540 (1,280*) mm | 0.15 mm dia. | |
| | | | NVG | 40 (120*) mm | 0.5 mm dia. | |
| VG | 40 (120*) mm | 0.5 mm dia. | | | | |

Note: * Value in parentheses represents the sensing distance of the fiber when the E39-F1 lens is attached to its tip.

** Value in parentheses is based on each fiber having a cable length of 2 m.

■ THROUGH-BEAM, GENERAL PURPOSE TYPE

The table specifies the sensing characteristics of each fiber when used with the following amplifiers:

Legend:

A E3X-A (General purpose amplifier)

DAN-HS E3X-DAN (Digital amplifier- high speed mode)

DAN-LD E3X-DAN (Digital amplifier- long distance mode)

DAN-SM E3X-DAN (Digital amplifier- standard distance mode)

F E3X-F (High performance amplifier- high speed)

H E3X-H11 (High gain amplifier)

NM E3X-NM (4 channel auto-tuning amplifier)

NT E3X-NT (Auto-tuning amplifier: general purpose)





NH E3X-NH (High-precision, auto-tuning amplifier)

NHB E3X-NHB (High-precision, blue LED, auto-tuning amp)

NV E3X-NV21 (Water-resistant, red light source amplifier)

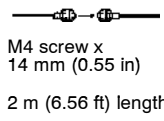
NVG E3X-NVG21 (Water-resistant, green light source amp)

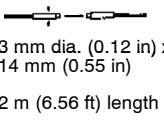
VG E3X-VG (Mark sensing amplifier)

| Application | Features | Appearance | Type | Detection distance | Min. detectable object (opaque) | Part number |
|-----------------------------------|--|---|--------|--------------------|---------------------------------|---|
| Flexible (resists breaking) | Can be bent like electric wires; 1 mm bending radius |  M4 screw x 14 mm (0.55 in) 2 m (6.56 ft) length | A | 140 (1,000*) | 0.2 mm dia. | E32-T11R  |
| | | | DAN-HS | 200 (1,400*) mm | ----- | |
| | | | DAN-LD | 670 (4,000**) mm | ----- | |
| | | | DAN-SM | 530 (3,700*) mm | 0.01 mm dia. | |
| | | | F | Contact Omron | Contact Omron | |
| | | | H | 280 (2,100*) | Contact Omron | |
| | | | NH | 280 mm (2,100*) | 0.1 mm dia. | |
| | | | NHB | Contact Omron | Contact Omron | |
| | | | NM | 180 (1,300*) mm | 0.2 mm dia. | |
| | | | NT | 200 (1,400*) mm | 0.1 mm dia. | |
| | | | NV | 200 (1,400*) mm | 0.1 mm dia. | |
| | | | NVG | Contact Omron | Contact Omron | |
| | | | VG | Contact Omron | Contact Omron | |
| Long distance | Compact unthreaded head; 1 mm ID fiber |  3 mm dia. (0.12 in) x 14 mm (0.55 in) 2 m (6.56 ft) length | A | 350 mm | 0.5 mm dia. | E32-T12L  |
| | | | DAN-HS | 490 mm | ----- | |
| | | | DAN-LD | 1,660 mm | ----- | |
| | | | DAN-SM | 1,330 mm | 0.01 mm dia. | |
| | | | F | 150 mm | 0.5 mm dia. | |
| | | | H | 700 mm | 0.5 mm dia. | |
| | | | NH | 700 mm | 0.06 mm dia. | |
| | | | NHB | 90 mm | 0.06 mm dia. | |
| | | | NM | 500 mm | 0.2 mm dia. | |
| | | | NT | 540 mm | 0.15 mm dia. | |
| | | | NV | 540 mm | 0.15 mm dia. | |
| | | | NVG | 40 mm | 0.5 mm dia. | |
| | | | VG | 40 mm | 0.5 mm dia. | |

Note: * Value in parentheses represents the sensing distance of the fiber when the E39-F1 lens is attached to its tip.

** Value in parentheses is based on each fiber having a cable length of 2 m.

■ THROUGH-BEAM, GENERAL PURPOSE TYPE

The table specifies the sensing characteristics of each fiber when used with the following amplifiers:

Legend:

A E3X-A (General purpose amplifier)

DAN-HS E3X-DAN (Digital amplifier- high speed mode)

DAN-LD E3X-DAN (Digital amplifier- long distance mode)

DAN-SM E3X-DAN (Digital amplifier- standard distance mode)

F E3X-F (High performance amplifier- high speed)

H E3X-H11 (High gain amplifier)

NM E3X-NM (4 channel auto-tuning amplifier)

NT E3X-NT (Auto-tuning amplifier: general purpose)





NH E3X-NH (High-precision, auto-tuning amplifier)

NHB E3X-NHB (High-precision, blue LED, auto-tuning amp)

NV E3X-NV21 (Water-resistant, red light source amplifier)

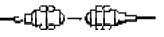
NVG E3X-NVG21 (Water-resistant, green light source amp)

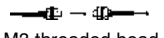
VG E3X-VG (Mark sensing amplifier)

| Application | Features | Appearance | Type | Detection distance | Min. detectable object (opaque) | Part number |
|-----------------------------|---|---|--------|--------------------|---------------------------------|---|
| Long distance | Magnifying lens extends sensing distance; ideal for explosion-proof applications; 25 mm bending radius; M14 head, 1 mm ID fiber |  M14 threaded head x 23 mm (0.91 in) L 10 m (32.8 ft) length | A | 7,000 mm | 0.8 mm dia. | E32-T17L  |
| | | | DAN-HS | 9,800 mm | ----- | |
| | | | DAN-LD | 20,000 mm * | ----- | |
| | | | DAN-SM | 20,000 mm * | 0.01 mm dia. | |
| | | | F | 3,000 mm | 1.5 mm dia. | |
| | | | H | 14,000 mm | 2.1 mm dia. | |
| | | | NH | 14,000 mm | 0.2 mm dia. | |
| | | | NHB | 2,000 mm | 0.2 mm dia. | |
| | | | NM | 7,000 mm | 0.7 mm dia. | |
| | | | NT | 7,500 mm | 0.5 mm dia. | |
| | | | NV | 7,500 mm | 0.5 mm dia. | |
| | | | NVG | 800 mm | 2.1 mm dia. | |
| VG | 800 mm | 2.1 mm dia. | | | | |
| Flexible (resists breaking) | Ideal for mounting on moving sections; 4 mm bending radius; 0.5 mm ID fiber |  M3 threaded head x 11 mm (0.43 in) L 2 m (6.56 ft) length | A | 50 mm | 0.2 mm dia. | E32-T21  |
| | | | DAN-HS | 80 mm | ----- | |
| | | | DAN-LD | 220 mm | ----- | |
| | | | DAN-SM | 200 mm | 0.01 mm dia. | |
| | | | F | 26 mm | 0.2 mm dia. | |
| | | | H | 100 mm | 0.2 mm dia. | |
| | | | NH | 100 mm | 0.04 mm dia. | |
| | | | NHB | Contact Omron | Contact Omron | |
| | | | NM | 65 mm | 0.2 mm dia. | |
| | | | NT | 70 mm | 0.1 mm dia. | |
| | | | NV | 70 mm | 0.1 mm dia. | |
| | | | NVG | 6 mm | 0.1 mm dia. | |
| VG | 6 mm | 0.2 mm dia. | | | | |

Note: * Value is based on each fiber having a cable length of 10 m.

■ THROUGH-BEAM, GENERAL PURPOSE TYPE

The table specifies the sensing characteristics of each fiber when used with the following amplifiers:

Legend:

A E3X-A (General purpose amplifier)

DAN-HS E3X-DAN (Digital amplifier- high speed mode)

DAN-LD E3X-DAN (Digital amplifier- long distance mode)

DAN-SM E3X-DAN (Digital amplifier- standard distance mode)

F E3X-F (High performance amplifier- high speed)

H E3X-H11 (High gain amplifier)

NM E3X-NM (4 channel auto-tuning amplifier)

NT E3X-NT (Auto-tuning amplifier: general purpose)





NH E3X-NH (High-precision, auto-tuning amplifier)

NHB E3X-NHB (High-precision, blue LED, auto-tuning amp)

NV E3X-NV21 (Water-resistant, red light source amplifier)

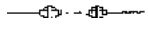
NVG E3X-NVG21 (Water-resistant, green light source amp)

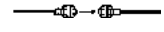
VG E3X-VG (Mark sensing amplifier)

| Application | Features | Appearance | Type | Detection distance | Min. detectable object (opaque) | Part number |
|-----------------------------|--|--|--------|--------------------|---------------------------------|---|
| Long distance | Compact mounting head; 25 mm bending radius; 0.5 mm ID fiber |  M3 threaded head x 9 mm (0.35 in) L 2 m (6.56 ft) length | A | 100 mm | 0.2 mm dia. | E32-T21L  |
| | | | DAN-HS | 180 mm | ----- | |
| | | | DAN-LD | 500 mm | ----- | |
| | | | DAN-SM | 440 mm | 0.01 mm dia. | |
| | | | F | 50 mm | 0.2 mm dia. | |
| | | | H | 200 mm | 0.2 mm dia. | |
| | | | NH | 200 mm | 0.04 mm dia. | |
| | | | NHB | Contact Omron | Contact Omron | |
| | | | NM | 150 mm | 0.2 mm dia. | |
| | | | NT | 160 mm | 0.1 mm dia. | |
| | | | NV | 160 mm | 0.1 mm dia. | |
| | | | NVG | 10 mm | 0.2 mm dia. | |
| | | | VG | 10 mm | 0.2 mm dia. | |
| Flexible (resists breaking) | Can be bent like electric wires; 1 mm bending radius |  M3 threaded head x 9.5 mm (0.37 in) L 2 m (6.56 ft) length | A | 30 mm | 0.2 mm dia. | E32-T21R  |
| | | | DAN-HS | 50 mm | ----- | |
| | | | DAN-LD | 150 mm | ----- | |
| | | | DAN-SM | 130 mm | 0.01 mm dia. | |
| | | | F | Contact Omron | Contact Omron | |
| | | | H | 60 mm | 0.2 mm dia. | |
| | | | NH | 60 mm | 0.1 mm dia. | |
| | | | NHB | Contact Omron | Contact Omron | |
| | | | NM | 40 mm | 0.2 mm dia. | |
| | | | NT | 41 mm | 0.1 mm dia. | |
| | | | NV | 41 mm | 0.1 mm dia. | |
| | | | NVG | Contact Omron | Contact Omron | |
| | | | VG | Contact Omron | Contact Omron | |

■ THROUGH-BEAM, GENERAL PURPOSE TYPE

The table specifies the sensing characteristics of each fiber when used with the following amplifiers:

Legend:

A E3X-A (General purpose amplifier)

DAN-HS E3X-DAN (Digital amplifier- high speed mode)

DAN-LD E3X-DAN (Digital amplifier- long distance mode)

DAN-SM E3X-DAN (Digital amplifier- standard distance mode)

F E3X-F (High performance amplifier- high speed)

H E3X-H11 (High gain amplifier)

NM E3X-NM (4 channel auto-tuning amplifier)

NT E3X-NT (Auto-tuning amplifier: general purpose)





NH E3X-NH (High-precision, auto-tuning amplifier)

NHB E3X-NHB (High-precision, blue LED, auto-tuning amp)

NV E3X-NV21 (Water-resistant, red light source amplifier)

NVG E3X-NVG21 (Water-resistant, green light source amp)

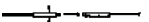
VG E3X-VG (Mark sensing amplifier)

| Application | Features | Appearance | Type | Detection distance | Min. detectable object (opaque) | Part number |
|----------------|--|---|--------|--------------------|---------------------------------|---|
| Minute objects | 2 mm dia. head fits in space-confined areas; 25 mm bending radius; 0.5 mm ID fiber |  2 mm dia. (0.8 in) x 22 mm (0.87 in) 2 m (6.56 ft) length | A | 50 mm | 0.1 mm dia. | E32-T22  |
| | | | DAN-HS | 90 mm | ----- | |
| | | | DAN-LD | 250 mm | ----- | |
| | | | DAN-SM | 220 mm | 0.01 mm dia. | |
| | | | F | 26 mm | 0.1 mm dia. | |
| | | | H | 100 mm | 0.1 mm dia. | |
| | | | NH | 100 mm | 0.04 mm dia. | |
| | | | NHB | Contact Omron | Contact Omron | |
| | | | NM | 70 mm | 0.2 mm dia. | |
| | | | NT | 75 mm | 0.1 mm dia. | |
| | | | NV | 75 mm | 0.1 mm dia. | |
| | | | NVG | 7 mm | 0.1 mm dia. | |
| | | | VG | 7 mm | 0.1 mm dia. | |
| Long distance | 2 mm dia. head fits in space-confined areas; 25 mm bending radius; 0.5 mm ID fiber |  2 mm dia. (0.8 in) x 22 mm (0.87 in) 2 m (6.56 ft) length | A | 100 mm | 0.2 mm dia. | E32-T22L  |
| | | | DAN-HS | 180 mm | ----- | |
| | | | DAN-LD | 500 mm | ----- | |
| | | | DAN-SM | 440 mm | 0.01 mm dia. | |
| | | | F | 50 mm | 0.2 mm dia. | |
| | | | H | 200 mm | 0.2 mm dia. | |
| | | | NH | 200 mm | 0.04 mm dia. | |
| | | | NHB | Contact Omron | Contact Omron | |
| | | | NM | 150 mm | 0.2 mm dia. | |
| | | | NT | 160 mm | 0.1 mm dia. | |
| | | | NV | 160 mm | 0.1 mm dia. | |
| | | | NVG | 10 mm | 0.2 mm dia. | |
| | | | VG | 10 mm | 0.2 mm dia. | |

■ THROUGH-BEAM, GENERAL PURPOSE TYPE

The table specifies the sensing characteristics of each fiber when used with the following amplifiers:

Legend:

A E3X-A (General purpose amplifier)

DAN-HS E3X-DAN (Digital amplifier- high speed mode)

DAN-LD E3X-DAN (Digital amplifier- long distance mode)

DAN-SM E3X-DAN (Digital amplifier- standard distance mode)

F E3X-F (High performance amplifier- high speed)

H E3X-H11 (High gain amplifier)

NM E3X-NM (4 channel auto-tuning amplifier)

NT E3X-NT (Auto-tuning amplifier: general purpose)





NH E3X-NH (High-precision, auto-tuning amplifier)

NHB E3X-NHB (High-precision, blue LED, auto-tuning amp)

NV E3X-NV21 (Water-resistant, red light source amplifier)

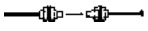
NVG E3X-NVG21 (Water-resistant, green light source amp)

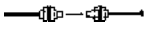
VG E3X-VG (Mark sensing amplifier)

| Application | Features | Appearance | Type | Detection distance | Min. detectable object (opaque) | Part number |
|-----------------|--|---|--------|--------------------|---------------------------------|---|
| General purpose | Compact threaded head; short cable length; 25 mm bending radius; 1 mm ID fiber |  M4 threaded head x 14 mm (0.55 in) L 50 cm (1.64 ft) length | A | 200 (1,500*) mm | 0.2 mm dia. | E32-TC50  |
| | | | DAN-HS | Contact Omron | Contact Omron | |
| | | | DAN-LD | Contact Omron | Contact Omron | |
| | | | DAN-SM | Contact Omron | Contact Omron | |
| | | | F | 80 mm | 0.2 mm dia. | |
| | | | H | 400 (3,000*) mm | 0.2 mm dia. | |
| | | | NH | Contact Omron | Contact Omron | |
| | | | NHB | Contact Omron | Contact Omron | |
| | | | NM | Contact Omron | Contact Omron | |
| | | | NT | Contact Omron | Contact Omron | |
| | | | NV | Contact Omron | Contact Omron | |
| | | | NVG | Contact Omron | Contact Omron | |
| | | | VG | 28 mm (190*) mm | 0.2 mm dia. | |
| General purpose | Compact threaded head; 25 mm bending radius; 1 mm ID fiber |  M4 threaded head x 14 mm (0.55 in) L 2 m (6.56 ft) length | A | 200 (1,500*) mm | 0.2 mm dia. | E32-TC200  |
| | | | DAN-HS | 280 (2,100*) mm | ----- | |
| | | | DAN-LD | 950 (4,000**) mm | ----- | |
| | | | DAN-SM | 760 (4,000**) mm | 0.01 mm dia. | |
| | | | F | 80 (670*) mm | 0.2 mm dia. | |
| | | | H | 400 (3,000*) mm | 0.2 mm dia. | |
| | | | NH | 400 (3,000*) mm | 0.04 mm dia. | |
| | | | NHB | 55 (420*) mm | 0.04 mm dia. | |
| | | | NM | 270 (2,000*) mm | 0.2 mm dia. | |
| | | | NT | 290 (2,100*) mm | 0.1 mm dia. | |
| | | | NV | 290 (2,100*) mm | 0.1 mm dia. | |
| | | | NVG | 28 mm (190*) mm | 0.2 mm dia. | |
| | | | VG | 28 mm (190*) mm | 0.2 mm dia. | |

Note: * Value in parentheses represents the sensing distance of the fiber when the E39-F1 lens is attached to its tip.

** Value in parentheses is based on each fiber having a cable length of 2 m.

■ THROUGH-BEAM, GENERAL PURPOSE TYPE

The table specifies the sensing characteristics of each fiber when used with the following amplifiers:

Legend:

A E3X-A (General purpose amplifier)

DAN-HS E3X-DAN (Digital amplifier- high speed mode)

DAN-LD E3X-DAN (Digital amplifier- long distance mode)

DAN-SM E3X-DAN (Digital amplifier- standard distance mode)

F E3X-F (High performance amplifier- high speed)

H E3X-H11 (High gain amplifier)

NM E3X-NM (4 channel auto-tuning amplifier)

NT E3X-NT (Auto-tuning amplifier: general purpose)





NH E3X-NH (High-precision, auto-tuning amplifier)

NHB E3X-NHB (High-precision, blue LED, auto-tuning amp)

NV E3X-NV21 (Water-resistant, red light source amplifier)

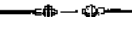
NVG E3X-NVG21 (Water-resistant, green light source amp)

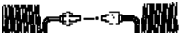
VG E3X-VG (Mark sensing amplifier)

| Application | Features | Appearance | Type | Detection distance | Min. detectable object (opaque) | Part number |
|-----------------|--|--|--------|--------------------|---------------------------------|---|
| General purpose | M3; possible to mount the reflective side-view conversion attachment (E39-F5); 25 mm bending radius; 1 mm ID fiber |  M3 threaded head x 7 mm (0.28 in) L 2 m (6.56 ft) length | A | 180 mm | 0.2 mm dia. | E32-TC200A  |
| | | | DAN-HS | 250 mm | ----- | |
| | | | DAN-LD | 850 mm | ----- | |
| | | | DAN-SM | 680 mm | 0.01 mm dia. | |
| | | | F | 80 mm | 0.2 mm dia. | |
| | | | H | 360 mm | 0.3 mm dia. | |
| | | | NH | 360 mm | 0.04 mm dia. | |
| | | | NHB | 55 mm | 0.04 mm dia. | |
| | | | NM | 250 mm | 0.2 mm dia. | |
| | | | NT | 270 mm | 0.1 mm dia. | |
| | | | NV | 270 mm | 0.1 mm dia. | |
| | | | NVG | 28 mm | 0.2 mm dia. | |
| | | | VG | 28 mm | 0.2 mm dia. | |
| General purpose | Spiral coiled cable withstands repeated stretching from reciprocating machine parts; 25 mm bending radius; 1 mm ID fiber |  M4 threaded head x 11 mm (0.43 in) L Coiled 56.5 cm (1.8 ft) L; 2 m (6.56 ft) extended | A | 150 (800*) mm | 0.2 mm dia. | E32-TC200C  |
| | | | DAN-HS | Contact Omron | Contact Omron | |
| | | | DAN-LD | Contact Omron | Contact Omron | |
| | | | DAN-SM | Contact Omron | Contact Omron | |
| | | | F | 60 (350*) mm | 0.2 mm dia. | |
| | | | H | 300 (1,600*) mm | 0.2 mm dia. | |
| | | | NH | 300 (3,600*) mm | 0.04 mm dia. | |
| | | | NHB | Contact Omron | Contact Omron | |
| | | | NM | 200 (800*) mm | 0.2 mm dia. | |
| | | | NT | 210 (850*) mm | 0.1 mm dia. | |
| | | | NV | 210 (850*) mm | 0.1 mm dia. | |
| | | | NVG | 18 (100*) mm | 0.2 mm dia. | |
| | | | VG | 18 (100*) mm | 0.2 mm dia. | |

Note: *Value in parentheses represents the sensing distance of the fiber when the E39-F1 lens is attached to its tip.

■ THROUGH-BEAM, GENERAL PURPOSE TYPE

Legend:

A E3X-A (General purpose amplifier)

DAN-HS E3X-DAN (Digital amplifier- high speed mode)

DAN-LD E3X-DAN (Digital amplifier- long distance mode)

DAN-SM E3X-DAN (Digital amplifier- standard distance mode)

F E3X-F (High performance amplifier- high speed)

H E3X-H11 (High gain amplifier)

NM E3X-NM (4 channel auto-tuning amplifier)

NT E3X-NT (Auto-tuning amplifier: general purpose)







NH E3X-NH (High-precision, auto-tuning amplifier)

NHB E3X-NHB (High-precision, blue LED, auto-tuning amp)

NV E3X-NV21 (Water-resistant, red light source amplifier)

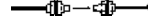
NVG E3X-NVG21 (Water-resistant, green light source amp)

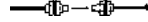
VG E3X-VG (Mark sensing amplifier)

| Application | Features | Appearance | Type | Detection distance | Min. detectable object (opaque) | Part number |
|-----------------|--|--|--------|--------------------|---------------------------------|---|
| General purpose | M3; suitable for detecting minute objects; 25 mm bending radius; 0.5 mm ID fiber |  M3 threaded head x 11 mm (0.43 in) L 2 m (6.56 ft) length | A | 50 mm | 0.1 mm dia. | E32-TC200E  |
| | | | DAN-HS | 90 mm | ----- | |
| | | | DAN-LD | 250 mm | ----- | |
| | | | DAN-SM | 220 mm | 0.01 mm dia. | |
| | | | F | 26 mm | 0.1 mm dia. | |
| | | | H | 100 mm | 0.1 mm dia. | |
| | | | NH | 100 mm | 0.04 mm dia. | |
| | | | NHB | Contact Omron | Contact Omron | |
| | | | NM | 70 mm | 0.2 mm dia. | |
| | | | NT | 75 mm | 0.1 mm dia. | |
| | | | NV | 75 mm | 0.1 mm dia. | |
| | | | NVG | 8 mm | 0.1 mm dia. | |
| | | | VG | 8 mm | 0.1 mm dia. | |
| General purpose | Extended length and sensing distance; 25 mm bending radius; 1 mm ID fiber |  M4 threaded head x 14 mm (0.55 in) L 5 m (16.4 ft) length | A | 200 (1,500*) mm | 0.2 mm dia. | E32-TC500  |
| | | | DAN-HS | Contact Omron | Contact Omron | |
| | | | DAN-LD | Contact Omron | Contact Omron | |
| | | | DAN-SM | Contact Omron | Contact Omron | |
| | | | F | 80 mm | 0.2 mm dia. | |
| | | | H | 400 (3,000*) mm | 0.2 mm dia. | |
| | | | NH | Contact Omron | Contact Omron | |
| | | | NHB | Contact Omron | Contact Omron | |
| | | | NM | Contact Omron | Contact Omron | |
| | | | NT | Contact Omron | Contact Omron | |
| | | | NV | Contact Omron | Contact Omron | |
| | | | NVG | Contact Omron | Contact Omron | |
| | | | VG | 28 mm | 0.2 mm dia. | |
| General purpose | Extended length and sensing distance; 25 mm bending radius; 1 mm ID fiber |  M4 threaded head x 14 mm (0.55 in) L 10 m (32.8 ft) length | A | 500 (1000*) mm | 0.01 mm dia. | E32-TC1000  |
| | | | DAN-HS | Contact Omron | Contact Omron | |
| | | | DAN-LD | Contact Omron | Contact Omron | |
| | | | DAN-SM | Contact Omron | Contact Omron | |
| | | | F | 500(1,000*) mm | 0.01 mm dia. | |
| | | | H | 500 (1,000*) mm | 0.01 mm dia. | |
| | | | NH | Contact Omron | Contact Omron | |
| | | | NHB | Contact Omron | Contact Omron | |
| | | | NM | Contact Omron | Contact Omron | |
| | | | NT | Contact Omron | Contact Omron | |
| | | | NV | Contact Omron | Contact Omron | |
| | | | NVG | Contact Omron | Contact Omron | |
| | | | VG | 500 (1,000*) mm | 0.01 mm dia. | |

Note: *Value in parentheses represents the sensing distance of the fiber when the E39-F1 lens is attached to its tip.

■ THROUGH-BEAM, ARMORED TYPE

The table specifies the sensing characteristics of each fiber when used with the following amplifiers:

Legend:

A E3X-A (General purpose amplifier)

DAN-HS E3X-DAN (Digital amplifier- high speed mode)

DAN-LD E3X-DAN (Digital amplifier- long distance mode)

DAN-SM E3X-DAN (Digital amplifier- standard distance mode)

F E3X-F (High performance amplifier- high speed)

H E3X-H11 (High gain amplifier)

NM E3X-NM (4 channel auto-tuning amplifier)

NT E3X-NT (Auto-tuning amplifier: general purpose)

NH E3X-NH (High-precision, auto-tuning amplifier)

NHB E3X-NHB (High-precision, blue LED, auto-tuning amp)

NV E3X-NV21 (Water-resistant, red light source amplifier)

NVG E3X-NVG21 (Water-resistant, green light source amp)

VG E3X-VG (Mark sensing amplifier)

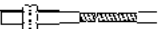
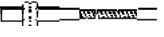
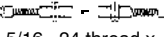
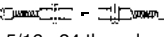
| Application | Features | Appearance | Type | Detection distance | Min. detectable object (opaque) | Part number |
|-----------------|---|--|-----------------|--------------------|---------------------------------|---------------------|
| General purpose | Can withstand temperatures to 150°C (302°F) |  5/16 - 24 thread x 3.8 mm (1.5 in) L 0.91 m (3 ft) length | A | 200 mm | 0.2 mm dia. | E32-UTAT1-3F |
| | | | DAN-HS | Contact Omron | Contact Omron | |
| | | | DAN-LD | Contact Omron | Contact Omron | |
| | | | DAN-SM | Contact Omron | Contact Omron | |
| | | | F | Contact Omron | Contact Omron | |
| | | | H | Contact Omron | Contact Omron | |
| | | | NH | Contact Omron | Contact Omron | |
| | | | NHB | Contact Omron | Contact Omron | |
| | | | NM | Contact Omron | Contact Omron | |
| | | | NT | Contact Omron | Contact Omron | |
| | | | NV | Contact Omron | Contact Omron | |
| | | | NVG | Contact Omron | Contact Omron | |
| VG | Contact Omron | Contact Omron | | | | |
| General purpose | Can withstand temperatures to 150°C (302°F) |  5/16 - 24 thread x 3.8 mm (1.5 in) L 1.83 m (6 ft) length | A | 170 mm | 0.2 mm dia. | E32-UTAT1-6F |
| | | | DAN-HS | Contact Omron | Contact Omron | |
| | | | DAN-LD | Contact Omron | Contact Omron | |
| | | | DAN-SM | Contact Omron | Contact Omron | |
| | | | F | Contact Omron | Contact Omron | |
| | | | H | Contact Omron | Contact Omron | |
| | | | NH | Contact Omron | Contact Omron | |
| | | | NHB | Contact Omron | Contact Omron | |
| | | | NM | Contact Omron | Contact Omron | |
| | | | NT | Contact Omron | Contact Omron | |
| | | | NV | Contact Omron | Contact Omron | |
| | | | NVG | Contact Omron | Contact Omron | |
| VG | Contact Omron | Contact Omron | | | | |
| General purpose | Can withstand temperatures to 200°C (392°F) |  5/16 - 24 thread x 38.1 mm (1.5 in) L 0.91 m (3 ft) length | E3JU-X amp only | 400 mm | 0.25 mm dia. | E32-UTBT1-3F |
| General purpose | Can withstand temperatures to 200°C (392°F) |  5/16 - 24 thread x 38.1 mm (1.5 in) L 1.83 m (6 ft) length | E3JU-X amp only | 400 mm | 0.25 mm dia. | E32-UTBT1-6F |

■ THROUGH-BEAM, PROBE TYPE

The table specifies the sensing characteristics of each fiber when used with the following amplifiers:

Legend:

A E3X-A (General purpose amplifier)

DAN-HS E3X-DAN (Digital amplifier- high speed mode)

DAN-LD E3X-DAN (Digital amplifier- long distance mode)

DAN-SM E3X-DAN (Digital amplifier- standard distance mode)

F E3X-F (High performance amplifier- high speed)

H E3X-H11 (High gain amplifier)

NM E3X-NM (4 channel auto-tuning amplifier)

NT E3X-NT (Auto-tuning amplifier: general purpose)





NH E3X-NH (High-precision, auto-tuning amplifier)

NHB E3X-NHB (High-precision, blue LED, auto-tuning amp)

NV E3X-NV21 (Water-resistant, red light source amplifier)

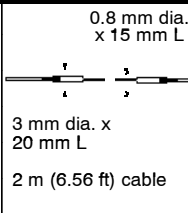
NVG E3X-NVG21 (Water-resistant, green light source amp)

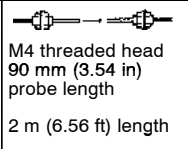
VG E3X-VG (Mark sensing amplifier)

| Application | Features | Appearance | Type | Detection distance | Min. detectable object (opaque) | Part number |
|--------------|---|--|--------|--------------------|---------------------------------|---|
| Needle probe | 303 stainless steel probe for ultra small objects; 12 mm heat shrink tubing can provide extra sealing and strain relief; 25 mm bending radius; 0.25 mm ID fiber |  <p>0.8 mm dia. x 15 mm L</p> <p>3 mm dia. x 20 mm L</p> <p>2 m (6.56 ft) cable</p> | A | 15 mm | 0.06 mm dia. | E32-T33-1  |
| | | | DAN-HS | Contact Omron | Contact Omron | |
| | | | DAN-LD | Contact Omron | Contact Omron | |
| | | | DAN-SM | Contact Omron | Contact Omron | |
| | | | F | 15 mm | 0.06 mm dia. | |
| | | | H | 15 mm | 0.06 mm dia. | |
| | | | NH | Contact Omron | Contact Omron | |
| | | | NHB | Contact Omron | Contact Omron | |
| | | | NM | Contact Omron | Contact Omron | |
| | | | NT | Contact Omron | Contact Omron | |
| | | | NV | Contact Omron | Contact Omron | |
| | | | NVG | Contact Omron | Contact Omron | |
| | | | VG | 15 mm | 0.06 mm dia. | |
| Thin fiber | Probe for space-confined sensing areas; 25 mm bending radius; 1 mm ID fiber. |  <p>M4 threaded head 90 mm (3.54 in) probe length</p> <p>2 m (6.56 ft) length</p> | A | 180 mm | 0.2 mm dia. | E32-TC200B  |
| | | | DAN-HS | 280 mm | ----- | |
| | | | DAN-LD | 950 mm | ----- | |
| | | | DAN-SM | 760 mm | 0.01 mm dia. | |
| | | | F | 80 mm | 0.2 mm dia. | |
| | | | H | 400 mm | 0.2 mm dia. | |
| | | | NH | 400 mm | 0.04 mm dia. | |
| | | | NHB | 55mm | 0.04 mm dia. | |
| | | | NM | 270 mm | 0.2 mm dia. | |
| | | | NT | 290 mm | 0.1 mm dia. | |
| | | | NV | 290 mm | 0.1 mm dia. | |
| | | | NVG | 28 mm | 0.2 mm dia. | |
| | | | VG | 28 mm | 0.2 mm dia. | |

■ THROUGH-BEAM, PROBE TYPE (CONT.)

Legend:

A E3X-A (General purpose amplifier)
 DAN-HS E3X-DAN (Digital amplifier- high speed mode)
 DAN-LD E3X-DAN (Digital amplifier- long distance mode)
 DAN-SM E3X-DAN (Digital amplifier- standard distance mode)
 F E3X-F (High performance amplifier- high speed)
 H E3X-H11 (High gain amplifier)

NM E3X-NM (4 channel auto-tuning amplifier)
 NT E3X-NT (Auto-tuning amplifier: general purpose)
 NH E3X-NH (High-precision, auto-tuning amplifier)
 NHB E3X-NHB (High-precision, blue LED, auto-tuning amp)
 NV E3X-NV21 (Water-resistant, red light source amplifier)
 NVG E3X-NVG21 (Water-resistant, green light source amp)
 VG E3X-VG (Mark sensing amplifier)

| Application | Features | Appearance | Type | Detection distance | Min. detectable object (opaque) | Part number |
|-------------|--|---|--------|--------------------|---------------------------------|--|
| Thin fiber | Probe for space-confined sensing areas; 25 mm bending radius; 1 mm ID fiber |  <p>M4 threaded head 40 mm (1.57 in) probe length</p> <p>2 m (6.56 ft) length</p> | A | 180 mm | 0.2 mm dia. | E32-TC200B4  |
| | | | DAN-HS | 280 mm | ----- | |
| | | | DAN-LD | 950 mm | ----- | |
| | | | DAN-SM | 760 mm | 0.01 mm dia. | |
| | | | F | 80 mm | 0.2 mm dia. | |
| | | | H | 400 mm | 0.2 mm dia. | |
| | | | NH | 400 mm | 0.04 mm dia. | |
| | | | NHB | 55 mm | 0.04 mm dia. | |
| | | | NM | 270 mm | 0.2 mm dia. | |
| | | | NT | 290 mm | 0.1 mm dia. | |
| | | | NV | 290 mm | 0.1 mm dia. | |
| | | | NVG | 28 mm | 0.2 mm dia. | |
| VG | 28 mm | 0.2 mm dia. | | | | |
| Thin probe | Sensing head with 90 mm probe; spiral coiled cable with-stands repeated stretching from reciprocating machine parts; 25 mm bending radius; 1 mm ID fiber |  <p>M4 threaded head 90 mm (3.54 in) probe length</p> <p>Coiled 56.6 cm (1.85 ft); 2 m (6.56 ft) when extended</p> | A | 150 mm | 0.2 mm dia. | E32-TC200D  |
| | | | DAN-HS | Contact Omron | Contact Omron | |
| | | | DAN-LD | Contact Omron | Contact Omron | |
| | | | DAN-SM | Contact Omron | Contact Omron | |
| | | | F | 60 mm | 0.2 mm dia. | |
| | | | H | 300 mm | 0.2 mm dia. | |
| | | | NH | 300 mm | 0.04 mm dia. | |
| | | | NHB | Contact Omron | Contact Omron | |
| | | | NM | Contact Omron | Contact Omron | |
| | | | NT | Contact Omron | Contact Omron | |
| | | | NV | Contact Omron | Contact Omron | |
| | | | NVG | Contact Omron | Contact Omron | |
| VG | 18 mm | 0.2 mm dia. | | | | |
| Thin probe | Sensing head with 40 mm probe; spiral coiled cable withstands repeated stretching from reciprocating machine parts; 25 mm bending radius; 1 mm ID fiber |  <p>M4 threaded head 40 mm (1.57 in) probe length</p> <p>Coiled 56.6 cm (1.85 ft); 2 m (6.56 ft) when extended</p> | A | 150 mm | 0.2 mm dia. | E32-TC200D4  |
| | | | DAN-HS | Contact Omron | Contact Omron | |
| | | | DAN-LD | Contact Omron | Contact Omron | |
| | | | DAN-SM | Contact Omron | Contact Omron | |
| | | | F | 60 mm | 0.2 mm dia. | |
| | | | H | 300 mm | 0.2 mm dia. | |
| | | | NH | 300 mm | 0.04 mm dia. | |
| | | | NHB | Contact Omron | Contact Omron | |
| | | | NM | Contact Omron | Contact Omron | |
| | | | NT | Contact Omron | Contact Omron | |
| | | | NV | Contact Omron | Contact Omron | |
| | | | NVG | Contact Omron | Contact Omron | |
| VG | 18 mm | 0.2 mm dia. | | | | |

■ THROUGH BEAM, PROBE TYPE (CONT.)

Legend:

A E3X-A (General purpose amplifier)

DAN-HS E3X-DAN (Digital amplifier- high speed mode)

DAN-LD E3X-DAN (Digital amplifier- long distance mode)

DAN-SM E3X-DAN (Digital amplifier- standard distance mode)

F E3X-F (High performance amplifier- high speed)

H E3X-H11 (High gain amplifier)

NM E3X-NM (4 channel auto-tuning amplifier)

NT E3X-NT (Auto-tuning amplifier: general purpose)





NH E3X-NH (High-precision, auto-tuning amplifier)

NHB E3X-NHB (High-precision, blue LED, auto-tuning amp)

NV E3X-NV21 (Water-resistant, red light source amplifier)

NVG E3X-NVG21 (Water-resistant, green light source amp)

VG E3X-VG (Mark sensing amplifier)

| Application | Features | Appearance | Type | Detection distance | Min. detectable object (opaque) | Part number |
|-------------|--|--|--------|--------------------|---------------------------------|--|
| Thin probe | Sensing head with 90 mm probe; 25 mm bending radius; 0.5 mm ID fiber |  M3 threaded head 90 mm (3.54 in) length probe 2 m (6.56 ft) length | A | 50 mm | 0.1 mm dia. | E32-TC200F  |
| | | | DAN-HS | 90 mm | ----- | |
| | | | DAN-LD | 250 mm | ----- | |
| | | | DAN-SM | 220 mm | 0.01 mm dia. | |
| | | | F | 26 mm | 0.1 mm dia. | |
| | | | H | 100 mm | 0.1 mm dia. | |
| | | | NH | 100 mm | 0.04 mm dia. | |
| | | | NHB | Contact Omron | Contact Omron | |
| | | | NM | 70 mm | 0.2 mm dia. | |
| | | | NT | 75 mm | 0.1 mm dia. | |
| | | | NV | 75 mm | 0.1 mm dia. | |
| | | | NVG | 8 mm | 0.1 mm dia. | |
| | | | VG | 8 mm | 0.1 mm dia. | |
| Thin probe | Sensing head with 40 mm probe; 25 mm bending radius; 0.5 mm ID fiber |  M3 threaded head 40 mm (1.57 in) length probe 2m (6.56 ft) length | A | 50 mm | 0.1 mm dia. | E32-TC200F4  |
| | | | DAN-HS | 90 mm | ----- | |
| | | | DAN-LD | 250 mm | ----- | |
| | | | DAN-SM | 220 mm | 0.01 mm dia. | |
| | | | F | 26 mm | 0.1 mm dia. | |
| | | | H | 100 mm | 0.1 mm dia. | |
| | | | NH | 100 mm | 0.04 mm dia. | |
| | | | NHB | Contact Omron | Contact Omron | |
| | | | NM | 70 mm | 0.2 mm dia. | |
| | | | NT | 75 mm | 0.1 mm dia. | |
| | | | NV | 75 mm | 0.1 mm dia. | |
| | | | NVG | 8 mm | 0.1 mm dia. | |
| | | | VG | 8 mm | 0.1 mm dia. | |

■ THROUGH-BEAM, SIDE BEAM TYPE

The table specifies the sensing characteristics of each fiber when used with the following amplifiers:

Legend:

A E3X-A (General purpose amplifier)

DAN-HS E3X-DAN (Digital amplifier- high speed mode)

DAN-LD E3X-DAN (Digital amplifier- long distance mode)

DAN-SM E3X-DAN (Digital amplifier- standard distance mode)

F E3X-F (High performance amplifier- high speed)

H E3X-H11 (High gain amplifier)

NM E3X-NM (4 channel auto-tuning amplifier)

NT E3X-NT (Auto-tuning amplifier: general purpose)





NH E3X-NH (High-precision, auto-tuning amplifier)

NHB E3X-NHB (High-precision, blue LED, auto-tuning amp)

NV E3X-NV21 (Water-resistant, red light source amplifier)

NVG E3X-NVG21 (Water-resistant, green light source amp)

VG E3X-VG (Mark sensing amplifier)

| Application | Features | Appearance | Type | Detection distance | Min. detectable object (opaque) | Part number |
|---------------|--|---|--------|--------------------|---------------------------------|--|
| Long distance | Built-in lens provides long sensing distance; each sensing head has two 3.2 mm screw mounting holes; 25 mm bending radius; 1 mm ID fiber |  2 m (6.56 ft) length | A | 900 mm | 0.2 mm dia. | E32-T14  |
| | | | DAN-HS | 1,250 mm | ----- | |
| | | | DAN-LD | 4,000 mm | ----- | |
| | | | DAN-SM | 3,400 mm | 0.01 mm dia. | |
| | | | F | 380 mm | 0.2 mm dia. | |
| | | | H | 1,800 mm | 0.2 mm dia. | |
| | | | NH | 1,800 mm | 0.08 mm dia. | |
| | | | NHB | 200mm | 0.08 mm dia. | |
| | | | NM | 1,000 mm | 0.2 mm dia. | |
| | | | NT | 1,070 mm | 0.2 mm dia. | |
| | | | NV | 1,070 mm | 0.2 mm dia. | |
| | | | NVG | 80 mm | 0.2 mm dia. | |
| | | | VG | 80 mm | 0.2 mm dia. | |
| Long distance | Space-saving mounting; 25 mm bending radius; 1 mm ID fiber |  3 mm (0.12 in) dia. x 35 mm (1.38 in) L 2 m (6.56 ft) length | A | 120 mm | 0.1 mm dia. | E32-T14L  |
| | | | DAN-HS | 170 mm | ----- | |
| | | | DAN-LD | 570 mm | ----- | |
| | | | DAN-SM | 460 mm | 0.01 mm dia. | |
| | | | F | 30 mm | 0.2 mm dia. | |
| | | | H | 240 mm | 0.2 mm dia. | |
| | | | NH | 240 mm | 0.08 mm dia. | |
| | | | NHB | 30 mm | 0.08 mm dia. | |
| | | | NM | 130 mm | 0.3 mm dia. | |
| | | | NT | 140 mm | 0.2 mm dia. | |
| | | | NV | 140 mm | 0.2 mm dia. | |
| | | | NVG | 10 mm | 0.1 mm dia. | |
| | | | VG | 10 mm | 0.1 mm dia. | |

■ THROUGH-BEAM, SIDE BEAM TYPE (CONT.)

The table specifies the sensing characteristics of each fiber when used with the following amplifiers:

Legend:

A E3X-A (General purpose amplifier)

DAN-HS E3X-DAN (Digital amplifier- high speed mode)

DAN-LD E3X-DAN (Digital amplifier- long distance mode)

DAN-SM E3X-DAN (Digital amplifier- standard distance mode)

F E3X-F (High performance amplifier- high speed)

H E3X-H11 (High gain amplifier)

NM E3X-NM (4 channel auto-tuning amplifier)

NT E3X-NT (Auto-tuning amplifier: general purpose)





NH E3X-NH (High-precision, auto-tuning amplifier)

NHB E3X-NHB (High-precision, blue LED, auto-tuning amp)

NV E3X-NV21 (Water-resistant, red light source amplifier)

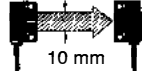
NVG E3X-NVG21 (Water-resistant, green light source amp)

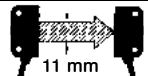
VG E3X-VG (Mark sensing amplifier)

| Application | Features | Appearance | Type | Detection distance | Min. detectable object (opaque) | Part number |
|--------------|--|--|--------|--------------------|---------------------------------|---|
| Area sensing | 10 mm wide beam, long sensing distance; 25 mm bending radius; 1 mm ID fiber; includes 0.5 mm and 1 mm slit masks |  2 m (6.56 ft) length | A | 750 mm | 6.0 mm dia.* | E32-T16  |
| | | | DAN-HS | 1,000 mm | ----- | |
| | | | DAN-LD | 3,500 mm | ----- | |
| | | | DAN-SM | 2,800 mm | 0.6 mm dia. | |
| | | | F | 330 mm | 7.0 mm dia.* | |
| | | | H | 1,500 mm | 6.0 mm dia.* | |
| | | | NH | 1,500 mm | 2.0 mm dia.* | |
| | | | NHB | 700 mm | 2.0 mm dia.* | |
| | | | NM | 1,000 mm | 5.0 mm dia.* | |
| | | | NT | 1,070 mm | 5.0 mm dia.* | |
| | | | NV | 1,070 mm | 5.0 mm dia.* | |
| | | | NVG | 150 mm | 7.0 mm dia.* | |
| | | | VG | 150 mm | 7.0 mm dia.* | |
| Area sensing | 11 mm wide beam; flexible cable allows 10 mm bending radius; 1 mm ID fiber; includes 0.5 mm and 1 mm slit masks |  2 m (6.56 ft) length | A | 300 mm | 2.0 mm dia.* | E32-T16P  |
| | | | DAN-HS | 420 mm | ----- | |
| | | | DAN-LD | 1,400 mm | ----- | |
| | | | DAN-SM | 1,100 mm | 0.2 mm dia. | |
| | | | F | Contact Omron | Contact Omron | |
| | | | H | Contact Omron | Contact Omron | |
| | | | NH | 600 mm | 0.4 mm dia.* | |
| | | | NHB | Contact Omron | Contact Omron | |
| | | | NM | 400 mm | 1.0 mm dia.* | |
| | | | NT | 480 mm | 1.3 mm dia.* | |
| | | | NV | 480 mm | 1.3 mm dia.* | |
| | | | NVG | Contact Omron | Contact Omron | |
| | | | VG | Contact Omron | Contact Omron | |

Note: *This value was measured at a sensing distance of 100 mm.

■ THROUGH-BEAM, SIDE BEAM TYPE (CONT.)

The table specifies the sensing characteristics of each fiber when used with the following amplifiers:

Legend:

A E3X-A (General purpose amplifier)

DAN-HS E3X-DAN (Digital amplifier- high speed mode)

DAN-LD E3X-DAN (Digital amplifier- long distance mode)

DAN-SM E3X-DAN (Digital amplifier- standard distance mode)

F E3X-F (High performance amplifier- high speed)

H E3X-H11 (High gain amplifier)

NM E3X-NM (4 channel auto-tuning amplifier)

NT E3X-NT (Auto-tuning amplifier: general purpose)



NH E3X-NH (High-precision, auto-tuning amplifier)

NHB E3X-NHB (High-precision, blue LED, auto-tuning amp)

NV E3X-NV21 (Water-resistant, red light source amplifier)

NVG E3X-NVG21 (Water-resistant, green light source amp)

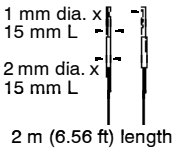
VG E3X-VG (Mark sensing amplifier)

| Application | Features | Appearance | Type | Detection distance | Min. detectable object (opaque) | Part number |
|----------------------------------|--|---|--------|--------------------|---------------------------------|--|
| Small objects; side view sensing | Suitable for detecting minute objects; 304 stainless steel needle tip; 25 mm bending radius; 0.5 mm ID fiber |  | A | 45 mm | 0.1 mm dia. | E32-T24  |
| | | | DAN-HS | 55 mm | ----- | |
| | | | DAN-LD | 150 mm | ----- | |
| | | | DAN-SM | 130 mm | 0.01 mm dia. | |
| | | | F | 15 mm | 0.3 mm dia. | |
| | | | H | 90 mm | 0.1 mm dia. | |
| | | | NH | 90 mm | 0.04 mm dia. | |
| | | | NHB | Contact Omron | Contact Omron | |
| | | | NM | 45 mm | 0.2 mm dia. | |
| | | | NT | 48 mm | 0.1 mm dia. | |
| | | | NV | 48 mm | 0.1 mm dia. | |
| | | | NVG | 2 mm | 0.2 mm dia. | |
| | | | VG | 2 mm | 0.2 mm dia. | |

■ THROUGH-BEAM, HIGH TEMPERATURE TYPE

The table specifies the sensing characteristics of each fiber when used with the following amplifiers:

Legend:

A E3X-A (General purpose amplifier)

DAN-HS E3X-DAN (Digital amplifier- high speed mode)

DAN-LD E3X-DAN (Digital amplifier- long distance mode)

DAN-SM E3X-DAN (Digital amplifier- standard distance mode)

F E3X-F (High performance amplifier- high speed)

H E3X-H11 (High gain amplifier)

NM E3X-NM (4 channel auto-tuning amplifier)

NT E3X-NT (Auto-tuning amplifier: general purpose)



NH E3X-NH (High-precision, auto-tuning amplifier)

NHB E3X-NHB (High-precision, blue LED, auto-tuning amp)

NV E3X-NV21 (Water-resistant, red light source amplifier)

NVG E3X-NVG21 (Water-resistant, green light source amp)

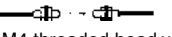
VG E3X-VG (Mark sensing amplifier)

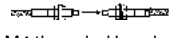
| Application | Features | Appearance | Type | Detection distance | Min. detectable object (opaque) | Part number |
|----------------|---|---|--------|--------------------|---------------------------------|--|
| Heat resistant | Resists 150°C; fiber sheath material: fluororesin. Operating ambient temperature: -40°C to 150°C (-40°F to 302°F); 1.5 mm ID fiber |  M4 threaded head x 17 mm (0.67 in) L 2 m (6.56 ft) length | A | 200 mm | 1.0 mm dia. | E32-T51  |
| | | | DAN-HS | 280 mm | ----- | |
| | | | DAN-LD | 950 mm | ----- | |
| | | | DAN-SM | 760 mm | 0.01 mm dia. | |
| | | | F | 80 mm | 1.0 mm dia. | |
| | | | H | 400 mm | 1.0 mm dia. | |
| | | | NH | 400 mm | 0.4 mm dia. | |
| | | | NHB | 35 mm | 0.4 mm dia. | |
| | | | NM | 300 mm | 0.4 mm dia. | |
| | | | NT | 320 mm | 0.3 mm dia. | |
| | | | NV | 320 mm | 0.3 mm dia. | |
| | | | NVG | 20 mm | 1.0 mm dia. | |
| | | | VG | 20 mm | 1.0 mm dia. | |
| Heat resistant | Resists 300°C, with spiral tube; high mechanical strength; fiber sheath material: stainless steel. Operating ambient temperature: -40°C to 300°C (-40°F to 572°F); 1 mm ID fiber |  M4 threaded head x 20 mm (0.79 in) L 2 m (6.56 ft) length | A | 150 (1,500*) mm | 0.2 mm dia. | E32-T61 |
| | | | DAN-HS | 170 (1,300*) mm | ----- | |
| | | | DAN-LD | 570 (4,000**) mm | ----- | |
| | | | DAN-SM | 450 (3,400*) mm | 0.01 mm dia. | |
| | | | F | 60 (450*) mm | 0.5 mm dia. | |
| | | | H | 300 (3,000*) mm | 0.3 mm dia. | |
| | | | NH | 300 (3,000*) mm | 0.12 mm dia. | |
| | | | NHB | Contact Omron | Contact Omron | |
| | | | NM | 180 (2,000*) mm | 0.2 mm dia. | |
| | | | NT | 190 (2,100*) mm | 0.15 mm dia. | |
| | | | NV | 190 (2,100*) mm | 0.15 mm dia. | |
| | | | NVG | 18 (130*) mm | 0.5 mm dia. | |
| | | | VG | 18 (130*) mm | 0.5 mm dia. | |

Note: * Value in parentheses represents the sensing distance of the fiber when the E39-F1 lens is attached to its tip.

**Value in parentheses is based on each fiber having a cable length of 2,000 mm.

■ THROUGH-BEAM, SPECIAL PURPOSE TYPE

The table specifies the sensing characteristics of each fiber when used with the following amplifiers:

Legend:

A E3X-A (General purpose amplifier)

DAN-HS E3X-DAN (Digital amplifier- high speed mode)

DAN-LD E3X-DAN (Digital amplifier- long distance mode)

DAN-SM E3X-DAN (Digital amplifier- standard distance mode)

F E3X-F (High performance amplifier- high speed)

H E3X-H11 (High gain amplifier)

NM E3X-NM (4 channel auto-tuning amplifier)

NT E3X-NT (Auto-tuning amplifier: general purpose)



NH E3X-NH (High-precision, auto-tuning amplifier)

NHB E3X-NHB (High-precision, blue LED, auto-tuning amp)

NV E3X-NV21 (Water-resistant, red light source amplifier)

NVG E3X-NVG21 (Water-resistant, green light source amp)

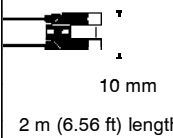
VG E3X-VG (Mark sensing amplifier)

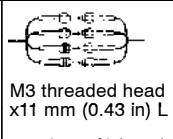
| Application | Features | Appearance | Type | Detection distance | Min. detectable object (opaque) | Part number |
|---------------------|---|--|--------|--------------------|---------------------------------|--|
| Mark/edge detection | Ideal for mark sensing or belt alignment; no optical axis adjustment required; easy to mount; 1 mm ID fiber |  10 mm 2 m (6.56 ft) length | A | 10 mm | 0.5 mm dia. | E32-G14  |
| | | | DAN-HS | 10 mm | ----- | |
| | | | DAN-LD | 10 mm | ----- | |
| | | | DAN-SM | 10 mm | 0.16 mm dia. | |
| | | | F | 10 mm | 0.5 mm dia. | |
| | | | H | 10 mm | Contact Omron | |
| | | | NH | 10 mm | Contact Omron | |
| | | | NHB | Contact Omron | Contact Omron | |
| | | | NM | 10 mm | 0.7 mm dia. | |
| | | | NT | 10 mm | 0.4 mm dia. | |
| | | | NV | 10 mm | 0.4 mm dia. | |
| | | | NVG | 10 mm | 0.6 mm dia. | |
| | | | VG | 10 mm | 0.6 mm dia. | |
| Area sensing | Use with E3XA-CC4A for shape recognition; 0.5 mm ID fiber |  M3 threaded head x11 mm (0.43 in) L 2 m (6.56 ft) length | A | 150 mm | 0.3 mm dia. | E32-M21 |
| | | | DAN-HS | 250 mm | ----- | |
| | | | DAN-LD | 700 mm | ----- | |
| | | | DAN-SM | 610 mm | 0.01 mm dia. | |
| | | | F | 65 mm | 0.3 mm dia. | |
| | | | H | 300 mm | 0.4 mm dia. | |
| | | | NH | 300 mm | 0.04 mm dia. | |
| | | | NHB | Contact Omron | Contact Omron | |
| | | | NM | 200 mm | 0.2 mm dia. | |
| | | | NT | 210 mm | 0.1 mm dia. | |
| | | | NV | 210 mm | 0.1 mm dia. | |
| | | | NVG | 20 mm | 0.3 mm dia. | |
| | | | VG | 20 mm | 0.3 mm dia. | |

■ THROUGH-BEAM, SPECIAL PURPOSE TYPE (CONT.)

The table specifies the sensing characteristics of each fiber when used with the following amplifiers:

Legend:

A E3X-A (General purpose amplifier)

DAN-HS E3X-DAN (Digital amplifier- high speed mode)

DAN-LD E3X-DAN (Digital amplifier- long distance mode)

DAN-SM E3X-DAN (Digital amplifier- standard distance mode)

F E3X-F (High performance amplifier- high speed)

H E3X-H11 (High gain amplifier)

NM E3X-NM (4 channel auto-tuning amplifier)

NT E3X-NT (Auto-tuning amplifier: general purpose)





NH E3X-NH (High-precision, auto-tuning amplifier)

NHB E3X-NHB (High-precision, blue LED, auto-tuning amp)

NV E3X-NV21 (Water-resistant, red light source amplifier)

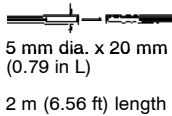
NVG E3X-NVG21 (Water-resistant, green light source amp)

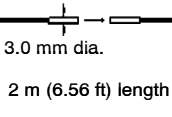
VG E3X-VG (Mark sensing amplifier)

| Application | Features | Appearance | Type | Detection distance | Min. detectable object (opaque) | Part number |
|--------------------|--|--|--------|--------------------|---------------------------------|---|
| Chemical resistant | Teflon-coated sensing head for harsh chemical environments. Operating ambient temperature: -30°C to 70°C (-22°F to 158°F); 1 mm ID fiber; 40 mm bending radius |  5 mm dia. x 20 mm (0.79 in L) 2 m (6.56 ft) length | A | 800 mm | 0.9 mm dia. | E32-T12F  |
| | | | DAN-HS | 1,100 mm | ----- | |
| | | | DAN-LD | 3,800 mm | ----- | |
| | | | DAN-SM | 3,000 mm | 0.01 mm dia. | |
| | | | F | 300 mm | 0.7 mm dia. | |
| | | | H | 1,600 mm | 0.7 mm dia. | |
| | | | NH | 1,600 mm | 0.12 mm dia. | |
| | | | NHB | 220 mm | 0.12 mm dia. | |
| | | | NM | 1,000 mm | 0.3 mm dia. | |
| | | | NT | 1,070 mm | 0.3 mm dia. | |
| | | | NV | 1,070 mm | 0.3 mm dia. | |
| | | | NVG | 70 mm | 0.6 mm dia. | |
| | | | VG | 70 mm | 0.6 mm dia. | |
| Wafer detection | Ultra narrow beam is ideal for sensing silicon wafers; 10 mm bending radius |  3.0 mm dia. 2 m (6.56 ft) length | A | Contact Omron | Contact Omron | E32-T22S  |
| | | | DAN-HS | 700 mm | ----- | |
| | | | DAN-LD | 2,300 mm | ----- | |
| | | | DAN-SM | 1,900 mm | 0.01 mm dia. | |
| | | | F | Contact Omron | Contact Omron | |
| | | | H | 1,000 mm | Contact Omron | |
| | | | NH | 1,000 mm | 0.08 mm dia. | |
| | | | NHB | Contact Omron | Contact Omron | |
| | | | NM | 650 mm | 0.4 mm dia. | |
| | | | NT | 650 mm | 0.2 mm dia. | |
| | | | NV | 650 mm | 0.2 mm dia. | |
| | | | NVG | Contact Omron | Contact Omron | |
| | | | VG | Contact Omron | Contact Omron | |

■ THROUGH-BEAM, SPECIAL PURPOSE TYPE (CONT.)

The table specifies the sensing characteristics of each fiber when used with the following amplifiers:

Legend:

A E3X-A (General purpose amplifier)

DAN-HS E3X-DAN (Digital amplifier- high speed mode)

DAN-LD E3X-DAN (Digital amplifier- long distance mode)

DAN-SM E3X-DAN (Digital amplifier- standard distance mode)

F E3X-F (High performance amplifier- high speed)

H E3X-H11 (High gain amplifier)

NM E3X-NM (4 channel auto-tuning amplifier)

NT E3X-NT (Auto-tuning amplifier: general purpose)



NH E3X-NH (High-precision, auto-tuning amplifier)

NHB E3X-NHB (High-precision, blue LED, auto-tuning amp)

NV E3X-NV21 (Water-resistant, red light source amplifier)

NVG E3X-NVG21 (Water-resistant, green light source amp)

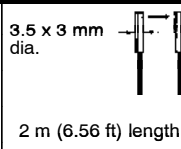
VG E3X-VG (Mark sensing amplifier)

| Application | Features | Appearance | Type | Detection distance | Min. detectable object (opaque) | Part number |
|-----------------|---|---|--------|--------------------|---------------------------------|---|
| Wafer detection | Side view with narrow field of vision; 10 mm bending radius |  <p>3.5 x 3 mm dia. 2 m (6.56 ft) length</p> | A | Contact Omron | Contact Omron | E32-T24S  |
| | | | DAN-HS | 500 mm | ----- | |
| | | | DAN-LD | 1,700 mm | ----- | |
| | | | DAN-SM | 1,300 mm | 0.01 mm dia. | |
| | | | F | Contact Omron | Contact Omron | |
| | | | H | 700 mm | Contact Omron | |
| | | | NH | 700 mm | 0.08 mm dia. | |
| | | | NHB | Contact Omron | Contact Omron | |
| | | | NM | 450 mm | 0.4 mm dia. | |
| | | | NT | 480 mm | 0.2 mm dia. | |
| | | | NV | 480 mm | 0.2 mm dia. | |
| | | | NVG | Contact Omron | Contact Omron | |
| | | | VG | Contact Omron | Contact Omron | |
| Heat resistant | Side view with stainless steel spiral tube sheath; resists 200°C (392°F) at the fiber tip; 25 mm bending radius |  <p>3 mm dia. 2 m (6.56 ft) length</p> | A | Contact Omron | Contact Omron | E32-T84S |
| | | | DAN-HS | 500 mm | ----- | |
| | | | DAN-LD | 1,700 mm | ----- | |
| | | | DAN-SM | 1,300 mm | 0.01 mm dia. | |
| | | | F | Contact Omron | Contact Omron | |
| | | | H | Contact Omron | Contact Omron | |
| | | | NH | 700 mm | 0.12 mm dia. | |
| | | | NHB | Contact Omron | Contact Omron | |
| | | | NM | 450 mm | 0.3 mm dia. | |
| | | | NT | 480 mm | 0.3 mm dia. | |
| | | | NV | 480 mm | 0.3 mm dia. | |
| | | | NVG | Contact Omron | Contact Omron | |
| | | | VG | Contact Omron | Contact Omron | |

■ DIFFUSE, GENERAL PURPOSE TYPE

The table specifies the sensing characteristics of each fiber when used with the following amplifiers:

Legend:

A E3X-A (General purpose amplifier)

DAN-HS E3X-DAN (Digital amplifier- high speed mode)

DAN-LD E3X-DAN (Digital amplifier- long distance mode)

DAN-SM E3X-DAN (Digital amplifier- standard distance mode)

F E3X-F (High performance amplifier- high speed)

H E3X-H11 (High gain amplifier)

NM E3X-NM (4 channel auto-tuning amplifier)

NT E3X-NT (Auto-tuning amplifier: general purpose)





NH E3X-NH (High-precision, auto-tuning amplifier)

NHB E3X-NHB (High-precision, blue LED, auto-tuning amp)

NV E3X-NV21 (Water-resistant, red light source amplifier)

NVG E3X-NVG21 (Water-resistant, green light source amp)

VG E3X-VG (Mark sensing amplifier)

| Application | Features | Appearance | Type | Detection distance (see note) | Min. detectable object (gold wire) | Part number |
|-----------------------------------|---|---|--------|----------------------------------|---------------------------------------|--|
| High accuracy positioning | Concentric beam: emitter in the center and a ring of 16 receivers in the 2.5 mm dia. tip; 25 mm bending radius; 1 mm ID fiber |  M6 threaded head x 20 mm (0.79 in) L 2 m (6.56 ft) length | A | 75 mm | 0.03 mm dia. | E32-CC200  |
| | | | DAN-HS | 100 mm | ----- | |
| | | | DAN-LD | 400 mm | ----- | |
| | | | DAN-SM | 300 mm | 0.01 mm dia. | |
| | | | F | 33 mm | 0.03 mm dia. | |
| | | | H | 150 mm | 0.015 mm dia. | |
| | | | NH | 150 mm | 0.012 mm dia. | |
| | | | NHB | 20 mm | 0.012 mm dia. | |
| | | | NM | 100 mm | 0.015 mm dia. | |
| | | | NT | 110 mm | 0.012 mm dia. | |
| | | | NV | 110 mm | 0.012 mm dia. | |
| | | | NVG | 10 mm | 0.5 mm dia. | |
| VG | 10 mm | 0.5 mm dia. | | | | |
| Flexible (resists breaking) | Thin fiber for small object detection, ultra flexible cable ; 4 mm bending radius; 0.25 mm ID fiber |  M6 threaded head x 17 mm (0.67 in) L 2 m (6.56 ft) length | A | 45 mm | 0.03 mm dia. | E32-D11  |
| | | | DAN-HS | 80 mm | ----- | |
| | | | DAN-LD | 220 mm | ----- | |
| | | | DAN-SM | 170 mm | 0.01 mm dia. | |
| | | | F | 20 mm | 0.03 mm dia. | |
| | | | H | 90 mm | 0.015 mm dia. | |
| | | | NH | 90 mm | 0.012 mm dia. | |
| | | | NHB | 12 mm | 0.012 mm dia. | |
| | | | NM | 60 mm | 0.015 mm dia. | |
| | | | NT | 65 mm | 0.012 mm dia. | |
| | | | NV | 65 mm | 0.012 mm dia. | |
| | | | NVG | 7 mm | 0.5 mm dia. | |
| VG | 7 mm | 0.5 mm dia. | | | | |

Note: Sensing distance is based on sensing a white paper that has 90% reflectivity.

■ DIFFUSE, GENERAL PURPOSE TYPE (CONT.)

The table specifies the sensing characteristics of each fiber when used with the following amplifiers:

Legend:

A E3X-A (General purpose amplifier)

DAN-HS E3X-DAN (Digital amplifier- high speed mode)

DAN-LD E3X-DAN (Digital amplifier- long distance mode)

DAN-SM E3X-DAN (Digital amplifier- standard distance mode)

F E3X-F (High performance amplifier- high speed)

H E3X-H11 (High gain amplifier)

NM E3X-NM (4 channel auto-tuning amplifier)

NT E3X-NT (Auto-tuning amplifier: general purpose)





NH E3X-NH (High-precision, auto-tuning amplifier)

NHB E3X-NHB (High-precision, blue LED, auto-tuning amp)

NV E3X-NV21 (Water-resistant, red light source amplifier)

NVG E3X-NVG21 (Water-resistant, green light source amp)

VG E3X-VG (Mark sensing amplifier)

| Application | Features | Appearance | Type | Detection distance (see note) | Min. detectable object (gold wire) | Part number |
|-----------------------------------|---|--|--------|----------------------------------|---------------------------------------|---|
| Long distance | Compact threaded sensing head; 25 mm bending radius; 1 mm ID fiber |  M6 threaded head x 17 mm (0.67 in) L 2 m (6.56 ft) length | A | 100 mm | 0.015 mm dia. | E32-D11L  |
| | | | DAN-HS | 150 mm | ----- | |
| | | | DAN-LD | 500 mm | ----- | |
| | | | DAN-SM | 400 mm | 0.01 mm dia. | |
| | | | F | 45 mm | 0.2 mm dia. | |
| | | | H | 200 mm | 0.015 mm dia. | |
| | | | NH | 200 mm | 0.012 mm dia. | |
| | | | NHB | 26 mm | 0.012 mm dia. | |
| | | | NM | 150 mm | 0.015 mm dia. | |
| | | | NT | 160 mm | 0.012 mm dia. | |
| | | | NV | 160 mm | 0.012 mm dia. | |
| | | | NVG | 10 mm | 3.0 mm dia. | |
| VG | 10 mm | 3.0 mm dia. | | | | |
| Flexible (resists breaking) | High flexibility with 1 mm minimum bending radius |  M6 screw x 17 mm (0.67 in) L 2 m (6.56 ft) length | A | 45 mm | 0.03 mm dia. | E32-D11R  |
| | | | DAN-HS | 80 mm | ----- | |
| | | | DAN-LD | 220 mm | ----- | |
| | | | DAN-SM | 170 mm | 0.01 mm dia. | |
| | | | F | Contact Omron | Contact Omron | |
| | | | H | Contact Omron | Contact Omron | |
| | | | NH | 90 mm | 0.02 mm dia. | |
| | | | NHB | Contact Omron | Contact Omron | |
| | | | NM | 60 mm | 0.02 mm dia. | |
| | | | NT | 65 mm | 0.02 mm dia. | |
| | | | NV | 65 mm | 0.02 mm dia. | |
| | | | NVG | 45 mm | 0.03 mm dia. | |
| VG | 45 mm | 0.03 mm dia. | | | | |

Note: Sensing distance is based on sensing a white paper that has 90% reflectivity.

■ DIFFUSE, GENERAL PURPOSE TYPE (CONT.)

The table specifies the sensing characteristics of each fiber when used with the following amplifiers:

Legend:

A E3X-A (General purpose amplifier)

DAN-HS E3X-DAN (Digital amplifier- high speed mode)

DAN-LD E3X-DAN (Digital amplifier- long distance mode)

DAN-SM E3X-DAN (Digital amplifier- standard distance mode)

F E3X-F (High performance amplifier- high speed)

H E3X-H11 (High gain amplifier)

NM E3X-NM (4 channel auto-tuning amplifier)

NT E3X-NT (Auto-tuning amplifier: general purpose)





NH E3X-NH (High-precision, auto-tuning amplifier)

NHB E3X-NHB (High-precision, blue LED, auto-tuning amp)

NV E3X-NV21 (Water-resistant, red light source amplifier)

NVG E3X-NVG21 (Water-resistant, green light source amp)

VG E3X-VG (Mark sensing amplifier)

| Application | Features | Appearance | Type | Detection distance (see note) | Min. detectable object (gold wire) | Part number |
|-----------------------------------|--|--|--------|----------------------------------|---------------------------------------|---|
| Flexible (resists breaking) | Flexible thin fiber requires just 4 mm bending radius; mount on moving machinery sections; 0.25 mm ID fiber |  M3 threaded head x 11 mm (0.43 in) L 2 m (6.56 ft) length | A | 7 mm | 0.03 mm dia. | E32-D21  |
| | | | DAN-HS | 10 mm | ----- | |
| | | | DAN-LD | 40 mm | ----- | |
| | | | DAN-SM | 30 mm | 0.01 mm dia. | |
| | | | F | 3 mm | 0.03 mm dia. | |
| | | | H | 14 mm | 0.015 mm dia. | |
| | | | NH | 14 mm | 0.012 mm dia. | |
| | | | NHB | Contact Omron | Contact Omron | |
| | | | NM | 8 mm | 0.015 mm dia. | |
| | | | NT | 9 mm | 0.012 mm dia. | |
| | | | NV | 9 mm | 0.012 mm dia. | |
| | | | NVG | 1 mm | 1.0 mm dia. | |
| VG | 1 mm | 1.0 mm dia. | | | | |
| Long distance | Small sensing head is easy to mount; 25 mm bending radius |  M4 threaded head x 12 mm (0.47 in) L 2 m (6.56 ft) length | A | 25 mm | 0.03 mm dia. | E32-D21L  |
| | | | DAN-HS | 45 mm | ----- | |
| | | | DAN-LD | 160 mm | ----- | |
| | | | DAN-SM | 130 mm | 0.01 mm dia. | |
| | | | F | 11 mm | 0.26 mm dia. | |
| | | | H | 50 mm | 0.015 mm dia. | |
| | | | NH | 50 mm | 0.012 mm dia. | |
| | | | NHB | Contact Omron | Contact Omron | |
| | | | NM | 35 mm | 0.015 mm dia. | |
| | | | NT | 38 mm | 0.012 mm dia. | |
| | | | NV | 38 mm | 0.012 mm dia. | |
| | | | NVG | 1 mm | 1.0 mm dia. | |
| VG | 1 mm | 1.0 mm dia. | | | | |

Note: Sensing distance is based on sensing a white paper that has 90% reflectivity.

■ DIFFUSE, GENERAL PURPOSE TYPE (CONT.)

The table specifies the sensing characteristics of each fiber when used with the following amplifiers:

Legend:

A E3X-A (General purpose amplifier)

DAN-HS E3X-DAN (Digital amplifier- high speed mode)

DAN-LD E3X-DAN (Digital amplifier- long distance mode)

DAN-SM E3X-DAN (Digital amplifier- standard distance mode)

F E3X-F (High performance amplifier- high speed)

H E3X-H11 (High gain amplifier)

NM E3X-NM (4 channel auto-tuning amplifier)

NT E3X-NT (Auto-tuning amplifier: general purpose)





NH E3X-NH (High-precision, auto-tuning amplifier)

NHB E3X-NHB (High-precision, blue LED, auto-tuning amp)

NV E3X-NV21 (Water-resistant, red light source amplifier)

NVG E3X-NVG21 (Water-resistant, green light source amp)

VG E3X-VG (Mark sensing amplifier)

| Application | Features | Appearance | Type | Detection distance (see note) | Min. detectable object (gold wire) | Part number |
|-----------------------------------|--|--|--------|----------------------------------|---------------------------------------|---|
| Flexible (resists breaking) | Easy to mount sensing head with high flexibility cable; 1 mm bending radius |  M3 screw x 11 mm (0.43 in) L 2 m (6.56 ft) length | A | 7 mm | 0.03 mm dia. | E32-D21R  |
| | | | DAN-HS | 10 mm | ----- | |
| | | | DAN-LD | 40 mm | ----- | |
| | | | DAN-SM | 30 mm | 0.01 mm dia. | |
| | | | F | Contact Omron | Contact Omron | |
| | | | H | Contact Omron | Contact Omron | |
| | | | NH | 14 mm | 0.02 mm dia. | |
| | | | NHB | NA | NA | |
| | | | NM | 8 mm | 0.02 mm dia. | |
| | | | NT | 9 mm | 0.02 mm dia. | |
| | | | NV | 9 mm | 0.02 mm dia. | |
| | | | NVG | NA | NA | |
| VG | NA | NA | | | | |
| Long distance | Small diameter head fits space-confined installations; 25 mm bending radius; 0.5 mm ID fiber |  3 mm (0.12 in) dia. x 15 mm (0.59 in) L 2 m (6.56 ft) length | A | 25 mm | 0.03 mm dia. | E32-D22L  |
| | | | DAN-HS | 45 mm | ----- | |
| | | | DAN-LD | 160 mm | ----- | |
| | | | DAN-SM | 130 mm | 0.01 mm dia. | |
| | | | F | 11 mm | 0.26 mm dia. | |
| | | | H | 50 mm | 0.015 mm dia. | |
| | | | NH | 50 mm | 0.012 mm dia. | |
| | | | NHB | Contact Omron | Contact Omron | |
| | | | NM | 35 mm | 0.015 mm dia. | |
| | | | NT | 38 mm | 0.012 mm dia. | |
| | | | NV | 38 mm | 0.012 mm dia. | |
| | | | NVG | 1 mm | 1.0 mm dia. | |
| VG | 1 mm | 1.0 mm dia. | | | | |

Note: Sensing distance is based on sensing a white paper that has 90% reflectivity.

■ DIFFUSE, GENERAL PURPOSE TYPE (CONT.)

The table specifies the sensing characteristics of each fiber when used with the following amplifiers:

Legend:

A E3X-A (General purpose amplifier)

DAN-HS E3X-DAN (Digital amplifier- high speed mode)

DAN-LD E3X-DAN (Digital amplifier- long distance mode)

DAN-SM E3X-DAN (Digital amplifier- standard distance mode)

F E3X-F (High performance amplifier- high speed)

H E3X-H11 (High gain amplifier)

NM E3X-NM (4 channel auto-tuning amplifier)

NT E3X-NT (Auto-tuning amplifier: general purpose)





NH E3X-NH (High-precision, auto-tuning amplifier)

NHB E3X-NHB (High-precision, blue LED, auto-tuning amp)

NV E3X-NV21 (Water-resistant, red light source amplifier)

NVG E3X-NVG21 (Water-resistant, green light source amp)

VG E3X-VG (Mark sensing amplifier)

| Application | Features | Appearance | Type | Detection distance (see note) | Min. detectable object (gold wire) | Part number |
|--|---|--|--------|----------------------------------|---------------------------------------|---|
| Precise positioning | Concentric beam: light source in the center with a ring of 4 receivers in 2 mm dia. tip; 25 mm bending radius; 0.25 mm ID fiber |  2 mm (0.08 in) dia. x 15 mm (0.59 in) tip; 29 mm (1.14 in) L overall 2 m (6.56 ft) length | A | 20 mm | 0.03 mm dia. | E32-D32  |
| | | | DAN-HS | 25 mm | ----- | |
| | | | DAN-LD | 100 mm | ----- | |
| | | | DAN-SM | 75 mm | 0.01 mm dia. | |
| | | | F | 9 mm | 0.03 mm dia. | |
| | | | H | 40 mm | 0.015 mm dia. | |
| | | | NH | 40 mm | 0.012 mm dia. | |
| | | | NHB | Contact Omron | Contact Omron | |
| | | | NM | 30 mm | 0.015 mm dia. | |
| | | | NT | 33 mm | 0.012 mm dia. | |
| | | | NV | 33 mm | 0.012 mm dia. | |
| | | | NVG | 2.5 mm | 0.5 mm dia. | |
| | | | VG | 2.5 mm | 0.5 mm dia. | |
| Coaxial diffuse for precise positioning | Concentric beam: light source in the center with a ring of 16 receivers in 3 mm dia. tip; 25 mm bending radius |  3 mm (0.12 in) dia. x 15 mm (0.59 in) L 2 m (6.56 ft) length | A | 40 mm | 0.04 mm dia. | E32-D32L  |
| | | | DAN-HS | 50 mm | 0.01 mm dia. | |
| | | | DAN-LD | 200 mm | 0.01 mm dia. | |
| | | | DAN-SM | 150 mm | 0.01 mm dia. | |
| | | | F | 11 mm | 1.1 mm dia. | |
| | | | H | 80 mm | 0.015 mm dia. | |
| | | | NH | 80 mm | 0.012 mm dia. | |
| | | | NHB | Contact Omron | Contact Omron | |
| | | | NM | 60 mm | 0.04 mm dia. | |
| | | | NT | 65 mm | 0.012 mm dia. | |
| | | | NV | 65 mm | 0.012 mm dia. | |
| | | | NVG | 4 mm | 1 mm dia. | |
| | | | VG | 4 mm | 1 mm dia. | |

Note: Sensing distance is based on sensing a white paper that has 90% reflectivity.

■ DIFFUSE, GENERAL PURPOSE TYPE (CONT.)

The table specifies the sensing characteristics of each fiber when used with the following amplifiers:

Legend:

A E3X-A (General purpose amplifier)

DAN-HS E3X-DAN (Digital amplifier- high speed mode)

DAN-LD E3X-DAN (Digital amplifier- long distance mode)

DAN-SM E3X-DAN (Digital amplifier- standard distance mode)

F E3X-F (High performance amplifier- high speed)

H E3X-H11 (High gain amplifier)

NM E3X-NM (4 channel auto-tuning amplifier)

NT E3X-NT (Auto-tuning amplifier: general purpose)





NH E3X-NH (High-precision, auto-tuning amplifier)

NHB E3X-NHB (High-precision, blue LED, auto-tuning amp)

NV E3X-NV21 (Water-resistant, red light source amplifier)

NVG E3X-NVG21 (Water-resistant, green light source amp)

VG E3X-VG (Mark sensing amplifier)

| Application | Features | Appearance | Type | Detection distance (see note) | Min. detectable object (gold wire) | Part number |
|-----------------|---|---|--------|----------------------------------|---------------------------------------|--|
| General purpose | Compact threaded head; short cable length; 25 mm bending radius |  M6 threaded head x 14 mm (0.55 in) L 50 cm (19 in) length | A | 75 mm | 0.015 mm dia. | E32-DC50  |
| | | | DAN-HS | Contact Omron | Contact Omron | |
| | | | DAN-LD | Contact Omron | Contact Omron | |
| | | | DAN-SM | Contact Omron | Contact Omron | |
| | | | F | 33 mm | 0.015 mm dia. | |
| | | | H | 150 mm | 0.015 mm dia. | |
| | | | NH | Contact Omron | Contact Omron | |
| | | | NHB | Contact Omron | Contact Omron | |
| | | | NM | Contact Omron | Contact Omron | |
| | | | NT | Contact Omron | Contact Omron | |
| | | | NV | Contact Omron | Contact Omron | |
| | | | NVG | Contact Omron | Contact Omron | |
| VG | 10 mm | 0.2 mm dia. | | | | |
| General purpose | Compact threaded head; 25 mm bending radius; 1 mm ID fiber |  M6 threaded head x 14 mm (0.55 in) L 2 m (6.56 ft) length | A | 75 mm | 0.015 mm dia. | E32-DC200  |
| | | | DAN-HS | 100 mm | ----- | |
| | | | DAN-LD | 400 mm | ----- | |
| | | | DAN-SM | 300 mm | 0.01 mm dia. | |
| | | | F | 33 mm | 0.015 mm dia. | |
| | | | H | 150 mm | 0.015 mm dia. | |
| | | | NH | 150 mm | 0.012 mm dia. | |
| | | | NHB | 20 mm | 0.012 mm dia. | |
| | | | NM | 100 mm | 0.015 mm dia. | |
| | | | NT | 110 mm | 0.012 mm dia. | |
| | | | NV | 110 mm | 0.012 mm dia. | |
| | | | NVG | 10 mm | 0.2 mm dia. | |
| VG | 10 mm | 0.2 mm dia. | | | | |

Note: Sensing distance is based on sensing a white paper that has 90% reflectivity.

■ DIFFUSE, GENERAL PURPOSE TYPE (CONT.)

The table specifies the sensing characteristics of each fiber when used with the following amplifiers:

Legend:

A E3X-A (General purpose amplifier)

DAN-HS E3X-DAN (Digital amplifier- high speed mode)

DAN-LD E3X-DAN (Digital amplifier- long distance mode)

DAN-SM E3X-DAN (Digital amplifier- standard distance mode)

F E3X-F (High performance amplifier- high speed)

H E3X-H11 (High gain amplifier)

NM E3X-NM (4 channel auto-tuning amplifier)

NT E3X-NT (Auto-tuning amplifier: general purpose)





NH E3X-NH (High-precision, auto-tuning amplifier)

NHB E3X-NHB (High-precision, blue LED, auto-tuning amp)

NV E3X-NV21 (Water-resistant, red light source amplifier)

NVG E3X-NVG21 (Water-resistant, green light source amp)

VG E3X-VG (Mark sensing amplifier)

| Application | Features | Appearance | Type | Detection distance (see note) | Min. detectable object (gold wire) | Part number |
|-----------------|--|---|--------|----------------------------------|---------------------------------------|---|
| General purpose | Coiled cable ideal for moving parts; 25 mm bending radius; 1 mm ID fiber |  M6 threaded head x 17 mm (0.67 in) L Coiled 64 cm (2.1 ft) L; 2 m (6.56 ft) extended | A | 22 mm | 0.03 mm dia. | E32-DC200C  |
| | | | DAN-HS | Contact Omron | Contact Omron | |
| | | | DAN-LD | Contact Omron | Contact Omron | |
| | | | DAN-SM | Contact Omron | Contact Omron | |
| | | | F | 10 mm | 0.03 mm dia. | |
| | | | H | 44 mm | 0.015 mm dia. | |
| | | | NH | 44 mm | 0.012 mm dia. | |
| | | | NHB | Contact Omron | Contact Omron | |
| | | | NM | 30 mm | 0.015 mm dia. | |
| | | | NT | 33 mm | 0.012 mm dia. | |
| | | | NV | 33 mm | 0.012 mm dia. | |
| | | | NVG | 2.5 mm | 1.0 mm dia. | |
| VG | 2.5 mm | 1.0 mm dia. | | | | |
| General purpose | Thin fiber with small easy-to-mount head.; 25 mm bending radius; 0.5 mm ID fiber |  M3 threaded head x 11 mm (0.43 in) L 2 m (6.56 ft) length | A | 18 mm | 0.03 mm dia. | E32-DC200E  |
| | | | DAN-HS | 30 mm | ----- | |
| | | | DAN-LD | 100 mm | ----- | |
| | | | DAN-SM | 80 mm | 0.01 mm dia. | |
| | | | F | 8 mm | 0.03 mm dia. | |
| | | | H | 36 mm | 0.015 mm dia. | |
| | | | NH | 36 mm | 0.012 mm dia. | |
| | | | NHB | Contact Omron | Contact Omron | |
| | | | NM | 20 mm | 0.015 mm dia. | |
| | | | NT | 22 mm | 0.012 mm dia. | |
| | | | NV | 22 mm | 0.012 mm dia. | |
| | | | NVG | 2 mm | 1.0 mm dia. | |
| VG | 2 mm | 1.0 mm dia. | | | | |

Note: Sensing distance is based on sensing a white paper that has 90% reflectivity.

■ DIFFUSE, GENERAL PURPOSE TYPE (CONT.)

The table specifies the sensing characteristics of each fiber when used with the following amplifiers:

Legend:

A E3X-A (General purpose amplifier)

DAN-HS E3X-DAN (Digital amplifier- high speed mode)

DAN-LD E3X-DAN (Digital amplifier- long distance mode)

DAN-SM E3X-DAN (Digital amplifier- standard distance mode)

F E3X-F (High performance amplifier- high speed)

H E3X-H11 (High gain amplifier)

NM E3X-NM (4 channel auto-tuning amplifier)

NT E3X-NT (Auto-tuning amplifier: general purpose)





NH E3X-NH (High-precision, auto-tuning amplifier)

NHB E3X-NHB (High-precision, blue LED, auto-tuning amp)

NV E3X-NV21 (Water-resistant, red light source amplifier)

NVG E3X-NVG21 (Water-resistant, green light source amp)

VG E3X-VG (Mark sensing amplifier)

| Application | Features | Appearance | Type | Detection distance (see note) | Min. detectable object (gold wire) | Part number |
|-----------------|--|--|--------|----------------------------------|---------------------------------------|---|
| General purpose | Compact threaded head; 25 mm bending radius; 1 mm ID fiber |  M6 threaded head x 14 mm (0.55 in) L 5 m (16.4 ft) length | A | 75 mm | 0.015 mm dia. | E32-DC500  |
| | | | DAN-HS | Contact Omron | Contact Omron | |
| | | | DAN-LD | Contact Omron | Contact Omron | |
| | | | DAN-SM | Contact Omron | Contact Omron | |
| | | | F | 33 mm | 0.015 mm dia. | |
| | | | H | 150 mm | 0.015 mm dia. | |
| | | | NH | Contact Omron | Contact Omron | |
| | | | NHB | Contact Omron | Contact Omron | |
| | | | NM | Contact Omron | Contact Omron | |
| | | | NT | Contact Omron | Contact Omron | |
| | | | NV | Contact Omron | Contact Omron | |
| | | | NVG | Contact Omron | Contact Omron | |
| VG | 10 mm | 0.2 mm dia. | | | | |
| General purpose | Compact threaded head; 25 mm bending radius; 1 mm ID fiber |  M6 threaded head x 14 mm (0.55 in) L 10 m (32.8 ft) length | A | 75 mm | 0.015 mm dia. | E32-DC1000  |
| | | | DAN-HS | Contact Omron | Contact Omron | |
| | | | DAN-LD | Contact Omron | Contact Omron | |
| | | | DAN-SM | Contact Omron | Contact Omron | |
| | | | F | 33 mm | 0.015 mm dia. | |
| | | | H | 150 mm | 0.015 mm dia. | |
| | | | NH | Contact Omron | Contact Omron | |
| | | | NHB | Contact Omron | Contact Omron | |
| | | | NM | Contact Omron | Contact Omron | |
| | | | NT | Contact Omron | Contact Omron | |
| | | | NV | Contact Omron | Contact Omron | |
| | | | NVG | Contact Omron | Contact Omron | |
| VG | 10 mm | 0.2 mm dia. | | | | |

Note: Sensing distance is based on sensing a white paper that has 90% reflectivity.

■ DIFFUSE, ARMORED TYPE

The table specifies the sensing characteristics of each fiber when used with the following amplifiers:

Legend:

A E3X-A (General purpose amplifier)

DAN-HS E3X-DAN (Digital amplifier- high speed mode)

DAN-LD E3X-DAN (Digital amplifier- long distance mode)

DAN-SM E3X-DAN (Digital amplifier- standard distance mode)

F E3X-F (High performance amplifier- high speed)

H E3X-H11 (High gain amplifier)

NM E3X-NM (4 channel auto-tuning amplifier)

NT E3X-NT (Auto-tuning amplifier: general purpose)



NH E3X-NH (High-precision, auto-tuning amplifier)

NHB E3X-NHB (High-precision, blue LED, auto-tuning amp)

NV E3X-NV21 (Water-resistant, red light source amplifier)

NVG E3X-NVG21 (Water-resistant, green light source amp)

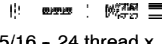
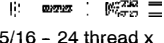
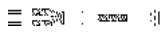
VG E3X-VG (Mark sensing amplifier)

| Application | Features | Appearance | Type | Detection distance (see note) | Min. detectable object (gold wire) | Part number |
|-----------------|---|--|-------------|----------------------------------|---------------------------------------|--------------|
| General purpose | Can withstand temperatures to 150°C (302°F) |  5/16 - 24 thread x 38.1 mm (1.5 in) L 0.91 m (3 ft) length | A | 80 mm | 0.03 mm dia. | E32-UDAT1-3F |
| | | | DAN-HS | Contact Omron | Contact Omron | |
| | | | DAN-LD | Contact Omron | Contact Omron | |
| | | | DAN-SM | Contact Omron | Contact Omron | |
| | | | F | Contact Omron | Contact Omron | |
| | | | H | Contact Omron | Contact Omron | |
| | | | NH | Contact Omron | Contact Omron | |
| | | | NHB | Contact Omron | Contact Omron | |
| | | | NM | Contact Omron | Contact Omron | |
| | | | NT | Contact Omron | Contact Omron | |
| | | | NV | Contact Omron | Contact Omron | |
| | | | NVG | Contact Omron | Contact Omron | |
| VG | Contact Omron | Contact Omron | | | | |
| General purpose | Can withstand temperatures to 150°C (302°F) |  5/16 - 24 thread x 38.1 mm (1.5 in) L 1.83 m (6 ft) length | A | 65 mm | 0.03 mm dia. | E32-UDAT1-6F |
| | | | DAN-HS | Contact Omron | Contact Omron | |
| | | | DAN-LD | Contact Omron | Contact Omron | |
| | | | DAN-SM | Contact Omron | Contact Omron | |
| | | | F | Contact Omron | Contact Omron | |
| | | | H | Contact Omron | Contact Omron | |
| | | | NH | Contact Omron | Contact Omron | |
| | | | NHB | Contact Omron | Contact Omron | |
| | | | NM | Contact Omron | Contact Omron | |
| | | | NT | Contact Omron | Contact Omron | |
| | | | NV | Contact Omron | Contact Omron | |
| | | | NVG | Contact Omron | Contact Omron | |
| VG | Contact Omron | Contact Omron | | | | |
| General purpose | Can withstand temperatures to 200°C (392°F) |  5/16 - 24 thread x 38.1 mm (1.5 in) L 0.91 m (3 ft) length | E3JU-X only | 90 mm | 0.05 mm dia. | E32-UDBT1-3F |
| General purpose | Can withstand temperatures to 200°C (392°F) |  5/16 - 24 thread x 38.1 mm (1.5 in) L 1.83 m (6 ft) length | E3JU-X only | 80 mm | 0.05 mm dia. | E32-UDBT1-6F |

■ DIFFUSE, PROBE TYPE

The table specifies the sensing characteristics of each fiber when used with the following amplifiers:

Legend:

A E3X-A (General purpose amplifier)

DAN-HS E3X-DAN (Digital amplifier- high speed mode)

DAN-LD E3X-DAN (Digital amplifier- long distance mode)

DAN-SM E3X-DAN (Digital amplifier- standard distance mode)

F E3X-F (High performance amplifier- high speed)

H E3X-H11 (High gain amplifier)

NM E3X-NM (4 channel auto-tuning amplifier)

NT E3X-NT (Auto-tuning amplifier: general purpose)





NH E3X-NH (High-precision, auto-tuning amplifier)

NHB E3X-NHB (High-precision, blue LED, auto-tuning amp)

NV E3X-NV21 (Water-resistant, red light source amplifier)

NVG E3X-NVG21 (Water-resistant, green light source amp)

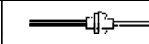
VG E3X-VG (Mark sensing amplifier)

| Application | Features | Appearance | Type | Detection distance (see note) | Min. detectable object (gold wire) | Part number |
|--------------|--|---|--------|----------------------------------|---------------------------------------|---|
| Needle probe | Super thin tip for minute object detection; 25 mm bending radius; 0.25 mm ID fiber |  3 mm dia. 0.8 mm dia. 2 m (6.56 ft) length | A | 5 mm | 0.015 mm dia. | E32-D33  |
| | | | DAN-HS | 6 mm | ----- | |
| | | | DAN-LD | 21 mm | ----- | |
| | | | DAN-SM | 16 mm | 0.01 mm dia. | |
| | | | F | 1.8 mm | 0.03 mm dia. | |
| | | | H | 10 mm | 0.015 mm dia. | |
| | | | NH | 10 mm | 0.012 mm dia. | |
| | | | NHB | NA | NA | |
| | | | NM | 6 mm | 0.015 mm dia. | |
| | | | NT | 7 mm | 0.012 mm dia. | |
| | | | NV | 7 mm | 0.012 mm dia. | |
| | | | NVG | NA | NA | |
| | | | VG | NA | NA | |
| Thin probe | Probe for space-confined sensing areas; 25 mm bending radius; 1 mm ID fiber |  M6 threaded head 90 mm (3.54 in) probe length 2 m (6.56 ft) length | A | 75 mm | 0.03 mm dia. | E32-DC200B  |
| | | | DAN-HS | 100 mm | ----- | |
| | | | DAN-LD | 400 mm | ----- | |
| | | | DAN-SM | 300 mm | 0.01 mm dia. | |
| | | | F | 33 mm | 0.03 mm dia. | |
| | | | H | 150 mm | 0.015 mm dia. | |
| | | | NH | 150 mm | 0.012 mm dia. | |
| | | | NHB | 20 mm | 0.012 mm dia. | |
| | | | NM | 100 mm | 0.015 mm dia. | |
| | | | NT | 110 mm | 0.012 mm dia. | |
| | | | NV | 110 mm | 0.012 mm dia. | |
| | | | NVG | 10 mm | 1.0 mm dia. | |
| | | | VG | 10 mm | 1.0 mm dia. | |

Note: Sensing distance is based on sensing a white paper that has 90% reflectivity.

■ DIFFUSE, PROBE TYPE (CONT.)

The table specifies the sensing characteristics of each fiber when used with the following amplifiers:

Legend:

A E3X-A (General purpose amplifier)

DAN-HS E3X-DAN (Digital amplifier- high speed mode)

DAN-LD E3X-DAN (Digital amplifier- long distance mode)

DAN-SM E3X-DAN (Digital amplifier- standard distance mode)

F E3X-F (High performance amplifier- high speed)

H E3X-H11 (High gain amplifier)

NM E3X-NM (4 channel auto-tuning amplifier)

NT E3X-NT (Auto-tuning amplifier: general purpose)





NH E3X-NH (High-precision, auto-tuning amplifier)

NHB E3X-NHB (High-precision, blue LED, auto-tuning amp)

NV E3X-NV21 (Water-resistant, red light source amplifier)

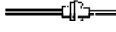
NVG E3X-NVG21 (Water-resistant, green light source amp)

VG E3X-VG (Mark sensing amplifier)

| Application | Features | Appearance | Type | Detection distance (see note) | Min. detectable object (gold wire) | Part number |
|-------------|--|---|--------|----------------------------------|---------------------------------------|--|
| Thin probe | Probe for space-confined sensing areas; 25 mm bending radius; 1 mm ID fiber |  <p>M6 threaded head 40 mm (1.57 in) probe length</p> <p>2 m (6.56 ft) length</p> | A | 75 mm | 0.03 mm dia. | E32-DC200B4  |
| | | | DAN-HS | 100 mm | ----- | |
| | | | DAN-LD | 400 mm | ----- | |
| | | | DAN-SM | 300 mm | 0.01 mm dia. | |
| | | | F | 33 mm | 0.03 mm dia. | |
| | | | H | 150 mm | 0.015 mm dia. | |
| | | | NH | 150 mm | 0.012 mm dia. | |
| | | | NHB | Contact Omron | Contact Omron | |
| | | | NM | 100 mm | 0.015 mm dia. | |
| | | | NT | 110 mm | 0.012 mm dia. | |
| | | | NV | 110 mm | 0.012 mm dia. | |
| | | | NVG | 10 mm | 1.0 mm dia. | |
| VG | 10 mm | 1.0 mm dia. | | | | |
| Thin probe | Sensing head with 90 mm probe; spiral coiled cable with-stands repeated stretching from reciprocating machine parts; 25 mm bending radius; 1 mm ID fiber |  <p>M6 threaded head 90 mm (3.54 in) probe length</p> <p>Coiled 64 cm (2.1 ft) L; 2 m (6.56 ft) extended</p> | A | 22 mm | 0.03 mm dia. | E32-DC200D  |
| | | | DAN-HS | Contact Omron | Contact Omron | |
| | | | DAN-LD | Contact Omron | Contact Omron | |
| | | | DAN-SM | Contact Omron | Contact Omron | |
| | | | F | 10 mm | 0.03 mm dia. | |
| | | | H | 44 mm | 0.015 mm dia. | |
| | | | NH | 44 mm | 0.012 mm dia. | |
| | | | NHB | Contact Omron | Contact Omron | |
| | | | NM | Contact Omron | Contact Omron | |
| | | | NT | Contact Omron | Contact Omron | |
| | | | NV | Contact Omron | Contact Omron | |
| | | | NVG | Contact Omron | Contact Omron | |
| VG | 2.5 mm | 1.0 mm dia. | | | | |

Note: Sensing distance is based on sensing a white paper that has 90% reflectivity.

■ DIFFUSE, PROBE TYPE (CONT.)

The table specifies the sensing characteristics of each fiber when used with the following amplifiers:

Legend:

A E3X-A (General purpose amplifier)

DAN-HS E3X-DAN (Digital amplifier- high speed mode)

DAN-LD E3X-DAN (Digital amplifier- long distance mode)

DAN-SM E3X-DAN (Digital amplifier- standard distance mode)

F E3X-F (High performance amplifier- high speed)

H E3X-H11 (High gain amplifier)

NM E3X-NM (4 channel auto-tuning amplifier)

NT E3X-NT (Auto-tuning amplifier: general purpose)







NH E3X-NH (High-precision, auto-tuning amplifier)

NHB E3X-NHB (High-precision, blue LED, auto-tuning amp)

NV E3X-NV21 (Water-resistant, red light source amplifier)

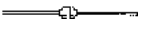
NVG E3X-NVG21 (Water-resistant, green light source amp)

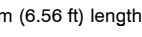
VG E3X-VG (Mark sensing amplifier)

| Application | Features | Appearance | Type | Detection distance (see note) | Min. detectable object (gold wire) | Part number |
|-------------|--|---|--------|----------------------------------|---------------------------------------|--|
| Thin probe | Sensing head with 40 mm probe; spiral coiled cable with-stands repeated stretching from reciprocating machine parts; 25 mm bending radius; 1 mm ID fiber |  M6 threaded head 40 mm (1.57 in) probe length  Coiled 64 cm (2.1 ft) L; 2 m (6.56 ft) extended | A | 22 mm | 0.03 mm dia. | E32-DC200D4  |
| | | | DAN-HS | Contact Omron | Contact Omron | |
| | | | DAN-LD | Contact Omron | Contact Omron | |
| | | | DAN-SM | Contact Omron | Contact Omron | |
| | | | F | 10 mm | 0.03 mm dia. | |
| | | | H | 44 mm | 0.015 mm dia. | |
| | | | NH | 44 mm | 0.012 mm dia. | |
| | | | NHB | Contact Omron | Contact Omron | |
| | | | NM | Contact Omron | Contact Omron | |
| | | | NT | Contact Omron | Contact Omron | |
| | | | NV | Contact Omron | Contact Omron | |
| | | | NVG | Contact Omron | Contact Omron | |
| Thin probe | Sensing head with 90 mm probe; 25 mm bending radius; 0.5 mm ID fiber |  M3 threaded head 90 mm (3.54 in) length probe  2 m (6.56 ft) length | A | 18 mm | 0.03 mm dia. | E32-DC200F  |
| | | | DAN-HS | 30 mm | ----- | |
| | | | DAN-LD | 100 mm | ----- | |
| | | | DAN-SM | 80 mm | 0.01 mm dia. | |
| | | | F | 8 mm | 0.03 mm dia. | |
| | | | H | 36 mm | 0.015 mm dia. | |
| | | | NH | 36 mm | 0.012 mm dia. | |
| | | | NHB | Contact Omron | Contact Omron | |
| | | | NM | 20 mm | 0.015 mm dia. | |
| | | | NT | 22 mm | 0.012 mm dia. | |
| | | | NV | 22 mm | 0.012 mm dia. | |
| | | | NVG | 2 mm | 1.0 mm dia. | |
| VG | 2 mm | 1.0 mm dia. | | | | |

Note: Sensing distance is based on sensing a white paper that has 90% reflectivity.

■ DIFFUSE, PROBE TYPE (CONT.)

Legend:

A E3X-A (General purpose amplifier)

DAN-HS E3X-DAN (Digital amplifier- high speed mode)

DAN-LD E3X-DAN (Digital amplifier- long distance mode)

DAN-SM E3X-DAN (Digital amplifier- standard distance mode)

F E3X-F (High performance amplifier- high speed)

H E3X-H11 (High gain amplifier)

NM E3X-NM (4 channel auto-tuning amplifier)

NT E3X-NT (Auto-tuning amplifier: general purpose)





NH E3X-NH (High-precision, auto-tuning amplifier)

NHB E3X-NHB (High-precision, blue LED, auto-tuning amp)

NV E3X-NV21 (Water-resistant, red light source amplifier)

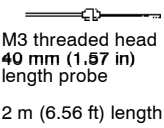
NVG E3X-NVG21 (Water-resistant, green light source amp)

VG E3X-VG (Mark sensing amplifier)

| Application | Features | Appearance | Type | Detection distance (see note) | Min. detectable object (gold wire) | Part number |
|-------------|---|--|--------|-------------------------------|------------------------------------|--|
| Thin probe | Sensing head with 40 mm probe; 25 mm bending radius; 0.5 mm ID fiber |  <p>M3 threaded head 40 mm (1.57 in) length probe</p> <p>2 m (6.56 ft) length</p> | A | 18 mm | 0.03 mm dia. | E32-DC200F4  |
| | | | DAN-HS | 30 mm | ----- | |
| | | | DAN-LD | 100 mm | ----- | |
| | | | DAN-SM | 80 mm | 0.01 mm dia. | |
| | | | F | 8 mm | 0.03 mm dia. | |
| | | | H | 36 mm | 0.015 mm dia. | |
| | | | NH | 36 mm | 0.012 mm dia. | |
| | | | NHB | Contact Omron | Contact Omron | |
| | | | NM | 20 mm | 0.015 mm dia. | |
| | | | NT | 22 mm | 0.012 mm dia. | |
| | | | NV | 22 mm | 0.012 mm dia. | |
| | | | NVG | 2 mm | 1.0 mm dia. | |
| | | | VG | 2 mm | 1.0 mm dia. | |
| Thin probe | 90 mm length probe mounts directly to amplifier; stainless steel probe; 1 mm ID fiber with 25 mm bending radius |  <p>1.2 mm dia.</p> | A | 30 mm | 0.03 mm dia. | E32-DC9G |
| | | | DAN-HS | Contact Omron | Contact Omron | |
| | | | DAN-LD | Contact Omron | Contact Omron | |
| | | | DAN-SM | Contact Omron | Contact Omron | |
| | | | F | 9 mm | 0.03 mm dia. | |
| | | | H | 60 mm | 0.015 mm dia. | |
| | | | NH | 60 mm | 0.012 mm dia. | |
| | | | NHB | Contact Omron | Contact Omron | |
| | | | NM | Contact Omron | Contact Omron | |
| | | | NT | Contact Omron | Contact Omron | |
| | | | NV | Contact Omron | Contact Omron | |
| | | | NVG | Contact Omron | Contact Omron | |
| | | | VG | 2.5 mm | 1.0 mm dia. | |
| Thin probe | 40 mm length probe mounts directly to amplifier; stainless steel probe; 1 mm ID fiber with 25 mm bending radius |  <p>1.2 mm dia.</p> | A | 30 mm | 0.03 mm dia. | E32-DC9G4 |
| | | | DAN-HS | Contact Omron | Contact Omron | |
| | | | DAN-LD | Contact Omron | Contact Omron | |
| | | | DAN-SM | Contact Omron | Contact Omron | |
| | | | F | 9 mm | 0.03 mm dia. | |
| | | | H | 60 mm | 0.015 mm dia. | |
| | | | NH | 60 mm | 0.012 mm dia. | |
| | | | NHB | Contact Omron | Contact Omron | |
| | | | NM | Contact Omron | Contact Omron | |
| | | | NT | Contact Omron | Contact Omron | |
| | | | NV | Contact Omron | Contact Omron | |
| | | | NVG | Contact Omron | Contact Omron | |
| | | | VG | 2.5 mm | 1.0 mm dia. | |

Note: Sensing distance is based on sensing a white paper that has 90% reflectivity.

■ DIFFUSE, SIDE BEAM TYPE

The table specifies the sensing characteristics of each fiber when used with the following amplifiers:

Legend:

A E3X-A (General purpose amplifier)

DAN-HS E3X-DAN (Digital amplifier- high speed mode)

DAN-LD E3X-DAN (Digital amplifier- long distance mode)

DAN-SM E3X-DAN (Digital amplifier- standard distance mode)

F E3X-F (High performance amplifier- high speed)

H E3X-H11 (High gain amplifier)

NM E3X-NM (4 channel auto-tuning amplifier)

NT E3X-NT (Auto-tuning amplifier: general purpose)





NH E3X-NH (High-precision, auto-tuning amplifier)

NHB E3X-NHB (High-precision, blue LED, auto-tuning amp)

NV E3X-NV21 (Water-resistant, red light source amplifier)

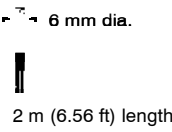
NVG E3X-NVG21 (Water-resistant, green light source amp)

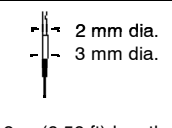
VG E3X-VG (Mark sensing amplifier)

| Application | Features | Appearance | Type | Detection distance (see note) | Min. detectable object (gold wire) | Part number |
|--|---|--|--------|----------------------------------|---------------------------------------|---|
| Long distance; side view sensing | Space-saving, side view probe for long sensing distances; 1 mm ID fiber; 25 mm bending radius |  6 mm dia. 2 m (6.56 ft) length | A | 40 mm | 0.03 mm dia. | E32-D14L  |
| | | | DAN-HS | 50 mm | ----- | |
| | | | DAN-LD | 150 mm | ----- | |
| | | | DAN-SM | 110 mm | 0.01 mm dia. | |
| | | | F | 12 mm | 0.5 mm dia. | |
| | | | H | 40 mm | 0.03 mm dia. | |
| | | | NH | 40 mm | 0.015 mm dia. | |
| | | | NHB | Contact Omron | Contact Omron | |
| | | | NM | 40 mm | 0.03 mm dia. | |
| | | | NT | 44 mm | 0.015 mm dia. | |
| | | | NV | 44 mm | 0.015 mm dia. | |
| | | | NVG | 1.5 mm | 1.0 mm dia. | |
| VG | 1.5 mm | 1.0 mm dia. | | | | |
| Small object | Side view; space saving thin fiber; 0.5 mm ID fiber; 25 mm bending radius |  2 mm dia. 3 mm dia. 2 m (6.56 ft) length | A | 15 mm | 0.03 mm dia. | E32-D24  |
| | | | DAN-HS | 10 mm | ----- | |
| | | | DAN-LD | 40 mm | ----- | |
| | | | DAN-SM | 30 mm | 0.01 mm dia. | |
| | | | F | 4 mm | 0.03 mm dia. | |
| | | | H | 15 mm | 0.03 mm dia. | |
| | | | NH | 15 mm | 0.012 mm dia. | |
| | | | NHB | Contact Omron | Contact Omron | |
| | | | NM | 15 mm | 0.03 mm dia. | |
| | | | NT | 17 mm | 0.012 mm dia. | |
| | | | NV | 17 mm | 0.012 mm dia. | |
| | | | NVG | 1.6 mm | 1.0 mm dia. | |
| VG | 1.6 mm | 1.0 mm dia. | | | | |

Note: Sensing distance is based on sensing a white paper that has 90% reflectivity.

■ DIFFUSE, HIGH TEMPERATURE TYPE

Legend:

A E3X-A (General purpose amplifier)

DAN-HS E3X-DAN (Digital amplifier- high speed mode)

DAN-LD E3X-DAN (Digital amplifier- long distance mode)

DAN-SM E3X-DAN (Digital amplifier- standard distance mode)

F E3X-F (High performance amplifier- high speed)

H E3X-H11 (High gain amplifier)

NM E3X-NM (4 channel auto-tuning amplifier)

NT E3X-NT (Auto-tuning amplifier: general purpose)



NH E3X-NH (High-precision, auto-tuning amplifier)

NHB E3X-NHB (High-precision, blue LED, auto-tuning amp)

NV E3X-NV21 (Water-resistant, red light source amplifier)

NVG E3X-NVG21 (Water-resistant, green light source amp)

VG E3X-VG (Mark sensing amplifier)

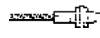
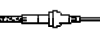
| Application | Features | Appearance | Type | Detection distance (see note) | Min. detectable object (gold wire) | Part number |
|----------------|---|--|--------|----------------------------------|---------------------------------------|--|
| Heat resistant | Resists 150°C; fiber sheath material: fluororesin. Operating ambient temperature: -40°C to 150°C (-40°F to 302°F); 1.5 mm ID fiber; 35 mm bending radius |  M6 threaded head 2 m (6.56 ft) length | A | 60 mm | 0.03 mm dia. | E32-D51  |
| | | | DAN-HS | 100 mm | ----- | |
| | | | DAN-LD | 300 mm | ----- | |
| | | | DAN-SM | 230 mm | 0.01 mm dia. | |
| | | | F | 26 mm | 0.03 mm dia. | |
| | | | H | 120 mm | 0.03 mm dia. | |
| | | | NH | 120 mm | 0.012 mm dia. | |
| | | | NHB | 12 mm | 0.012 mm dia. | |
| | | | NM | 60 mm | 0.03 mm dia. | |
| | | | NT | 65 mm | 0.012 mm dia. | |
| | | | NV | 65 mm | 0.012 mm dia. | |
| | | | NVG | 5 mm | 1.0 mm dia. | |
| Heat resistant | Resists 300°C, with spiral tube; high mechanical strength; fiber sheath material: stainless steel. Operating ambient temperature: -40°C to 300°C (-40°F to 572°F); 1.4 mm ID fiber; 25 mm bending radius |  M6 threaded head 2 m (6.56 ft) length | A | 45 mm | 0.03 mm dia. | E32-D61 |
| | | | DAN-HS | 30 mm | ----- | |
| | | | DAN-LD | 120 mm | ----- | |
| | | | DAN-SM | 90 mm | 0.01 mm dia. | |
| | | | F | 20 mm | 0.03 mm dia. | |
| | | | H | 45 mm | 0.03 mm dia. | |
| | | | NH | 45 mm | 0.012 mm dia. | |
| | | | NHB | Contact Omron | Contact Omron | |
| | | | NM | 45 mm | 0.03 mm dia. | |
| | | | NT | 50 mm | 0.012 mm dia. | |
| | | | NV | 50 mm | 0.012 mm dia. | |
| | | | NVG | 5 mm | 1.0 mm dia. | |
| Heat resistant | High temperature glass core fiber with probe. Resists 400°C, with spiral tube; high mechanical strength; fiber sheath material: stainless steel. Operating ambient temperature: -40°C to 400°C (-40°F to 752°F); 1 mm ID fiber; 25 mm bending radius |  1.25 mm dia M4 threaded head 2 m (6.56 ft) length | A | 30 mm | 0.03 mm dia. | E32-D73 |
| | | | DAN-HS | 20 mm | ----- | |
| | | | DAN-LD | 80 mm | ----- | |
| | | | DAN-SM | 60 mm | 0.01 mm dia. | |
| | | | F | 17 mm | 0.2 mm dia. | |
| | | | H | 30 mm | 0.03 mm dia. | |
| | | | NH | 30 mm | 0.012 mm dia. | |
| | | | NHB | Contact Omron | Contact Omron | |
| | | | NM | 30 mm | 0.03 mm dia. | |
| | | | NT | 33 mm | 0.012 mm dia. | |
| | | | NV | 33 mm | 0.012 mm dia. | |
| | | | NVG | 3 mm | 1.0 mm dia. | |
| VG | 3 mm | 1.0 mm dia. | | | | |

Note: Sensing distance is based on sensing a white paper that has 90% reflectivity.

■ DIFFUSE, CONVERGENT AND SPECIAL PURPOSE TYPES

The table specifies the sensing characteristics of each fiber when used with the following amplifiers:

Legend:

A E3X-A (General purpose amplifier)

DAN-HS E3X-DAN (Digital amplifier- high speed mode)

DAN-LD E3X-DAN (Digital amplifier- long distance mode)

DAN-SM E3X-DAN (Digital amplifier- standard distance mode)

F E3X-F (High performance amplifier- high speed)

H E3X-H11 (High gain amplifier)

NM E3X-NM (4 channel auto-tuning amplifier)

NT E3X-NT (Auto-tuning amplifier: general purpose)





NH E3X-NH (High-precision, auto-tuning amplifier)

NHB E3X-NHB (High-precision, blue LED, auto-tuning amp)

NV E3X-NV21 (Water-resistant, red light source amplifier)

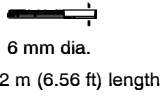
NVG E3X-NVG21 (Water-resistant, green light source amp)

VG E3X-VG (Mark sensing amplifier)

| Application | Features | Appearance | Type | Detection distance (see note) | Min. detectable object (gold wire) | Part number |
|-------------------------------------|--|--|--------|----------------------------------|---------------------------------------|--|
| Chemical resistant | Teflon coated sensing head for harsh chemical environments. Operating ambient temperature: -30°C to 70°C (-22°F to 158°F); 40 mm bending radius; 1 mm ID fiber |  6 mm dia. 2 m (6.56 ft) length | A | 50 mm | 0.03 mm dia. | E32-D12F  |
| | | | DAN-HS | 45 mm | ----- | |
| | | | DAN-LD | 120 mm | ----- | |
| | | | DAN-SM | 95 mm | 0.01 mm dia. | |
| | | | F | 20 mm | 0.5 mm dia. | |
| | | | H | 50 mm | 0.03 mm dia. | |
| | | | NH | 50 mm | 0.012 mm dia. | |
| | | | NHB | 10 mm | 0.012 mm dia. | |
| | | | NM | 50 mm | 0.03 mm dia. | |
| | | | NT | 55 mm | 0.012 mm dia. | |
| | | | NV | 55 mm | 0.012 mm dia. | |
| | | | NVG | 4 mm | 0.5 mm dia. | |
| | | | VG | 4 mm | 0.5 mm dia. | |
| Wafer detection, height differences | Convergent beam suppresses background objects; long distance, side view. Operating ambient temperature: -40°C to 105°C (-40°F to 221°F); 10 mm bending radius |  2 m (6.56 ft) length | A | 4 ± 2 mm | 0.015 mm dia. | E32-L24L  |
| | | | DAN-HS | 4 ± 2 mm | ----- | |
| | | | DAN-LD | 4 ± 2 mm | ----- | |
| | | | DAN-SM | 4 ± 2 mm | 0.01 mm dia. | |
| | | | F | 4 ± 2 mm | 0.015 mm dia. | |
| | | | H | 4 ± 2 mm | Contact Omron | |
| | | | NH | 4 ± 2 mm | 0.012 mm dia. | |
| | | | NHB | NA | NA | |
| | | | NM | 4 ± 2 mm | 0.015 mm dia. | |
| | | | NT | 4 ± 2 mm | 0.012 mm dia. | |
| | | | NV | 4 ± 2 mm | 0.012 mm dia. | |
| | | | NVG | NA | NA | |
| | | | VG | NA | NA | |

Note: Sensing distance is based on sensing a white paper that has 90% reflectivity.

■ DIFFUSE, CONVERGENT TYPES (CONT.)

Legend:

A E3X-A (General purpose amplifier)

DAN-HS E3X-DAN (Digital amplifier- high speed mode)

DAN-LD E3X-DAN (Digital amplifier- long distance mode)

DAN-SM E3X-DAN (Digital amplifier- standard distance mode)

F E3X-F (High performance amplifier- high speed)

H E3X-H11 (High gain amplifier)

NM E3X-NM (4 channel auto-tuning amplifier)

NT E3X-NT (Auto-tuning amplifier: general purpose)







NH E3X-NH (High-precision, auto-tuning amplifier)

NHB E3X-NHB (High-precision, blue LED, auto-tuning amp)

NV E3X-NV21 (Water-resistant, red light source amplifier)

NVG E3X-NVG21 (Water-resistant, green light source amp)

VG E3X-VG (Mark sensing amplifier)

| Application | Features | Appearance | Type | Detection distance (see note) | Min. detectable object (gold wire) | Part number |
|-------------------------------------|--|---|--------|-------------------------------|------------------------------------|---|
| Wafer detection, height differences | Convergent beam suppresses background objects; cable exits the side; 25 mm bending radius |  2 m (6.56 ft) length | A | 3.3 mm | 0.03 mm dia. | E32-L25  |
| | | | DAN-HS | 3.3 mm | ----- | |
| | | | DAN-LD | 3.3 mm | ----- | |
| | | | DAN-SM | 3.3 mm | 0.01 mm dia. | |
| | | | F | 3.3 mm | 0.5 mm dia. | |
| | | | H | 3.3 mm | 0.015 mm dia. | |
| | | | NH | 3.3 mm | 0.012 mm dia. | |
| | | | NHB | NA | NA | |
| | | | NM | 3.3 mm | 0.015 mm dia. | |
| | | | NT | 3.3 mm | 0.012 mm dia. | |
| | | | NV | 3.3 mm | 0.012 mm dia. | |
| | | | NVG | NA | NA | |
| VG | NA | NA | | | | |
| Wafer detection, height differences | Convergent beam suppresses background objects; cable exits the bottom; 25 mm bending radius |  2 m (6.56 ft) length | A | 3.3 mm | 0.03 mm dia. | E32-L25A  |
| | | | DAN-HS | 3.3 mm | ----- | |
| | | | DAN-LD | 3.3 mm | ----- | |
| | | | DAN-SM | 3.3 mm | 0.01 mm dia. | |
| | | | F | 3.3 mm | 0.5 mm dia. | |
| | | | H | 3.3 mm | 0.015 mm dia. | |
| | | | NH | 3.3 mm | 0.012 mm dia. | |
| | | | NHB | NA | NA | |
| | | | NM | 3.3 mm | 0.015 mm dia. | |
| | | | NT | 3.3 mm | 0.012 mm dia. | |
| | | | NV | 3.3 mm | 0.012 mm dia. | |
| | | | NVG | NA | NA | |
| VG | NA | NA | | | | |
| Wafer detection, height differences | Long distance convergent beam type suppresses background objects; cable exits the side; 10 mm bending radius |  2 m (6.56 ft) length | A | 7.2 ± 1.8 mm | 0.015 mm dia. | E32-L25L  |
| | | | DAN-HS | 7.2 ± 1.8 mm | ----- | |
| | | | DAN-LD | 7.2 ± 1.8 mm | ----- | |
| | | | DAN-SM | 7.2 ± 1.8 mm | 0.01 mm dia. | |
| | | | F | 7.2 ± 1.8 mm | 0.015 mm dia. | |
| | | | H | 7.2 ± 1.8 mm | 0.015 mm dia. | |
| | | | NH | 7.2 ± 1.8 mm | 0.012 mm dia. | |
| | | | NHB | NA | NA | |
| | | | NM | 7.2 ± 1.8 mm | 0.015 mm dia. | |
| | | | NT | 7.2 ± 1.8 mm | 0.012 mm dia. | |
| | | | NV | 7.2 ± 1.8 mm | 0.012 mm dia. | |
| | | | NVG | NA | NA | |
| VG | NA | NA | | | | |

Note: Sensing distance is based on sensing a white paper that has 90% reflectivity.

■ RETROREFLECTIVE TYPE

The table specifies the sensing characteristics of each fiber when used with the following amplifiers:

Legend:

A E3X-A (General purpose amplifier)

DAN-HS E3X-DAN (Digital amplifier- high speed mode)

DAN-LD E3X-DAN (Digital amplifier- long distance mode)

DAN-SM E3X-DAN (Digital amplifier- standard distance mode)

F E3X-F (High performance amplifier- high speed)

H E3X-H11 (High gain amplifier)

NM E3X-NM (4 channel auto-tuning amplifier)

NT E3X-NT (Auto-tuning amplifier: general purpose)





NH E3X-NH (High-precision, auto-tuning amplifier)

NHB E3X-NHB (High-precision, blue LED, auto-tuning amp)

NV E3X-NV21 (Water-resistant, red light source amplifier)

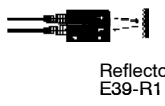
NVG E3X-NVG21 (Water-resistant, green light source amp)

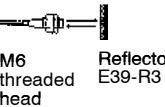
VG E3X-VG (Mark sensing amplifier)







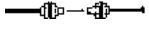

| Application | Features | Appearance | Type | Detection distance (see note) | Min. detectable object (gold wire) | Part number |
|---|--|---|--------|----------------------------------|---------------------------------------|--|
| Detects shiny, transpar- ent and opaque objects (polarized) | Block style sensing head detects objects over a long range; 25 mm bending radius |  Reflector E39-R1 2 m (6.56 ft) length | A | 150 to 1,500 mm | 0.6 mm dia. | E32-R16 +  E39-R1 |
| | | | DAN-HS | 150 to 1,500 mm | ----- | |
| | | | DAN-LD | 150 to 1,500 mm | ----- | |
| | | | DAN-SM | 150 to 1,500 mm | 0.2 mm dia. | |
| | | | F | 50 to 700 mm | 0.6 mm dia. | |
| | | | H | 150 to 1,500 mm | 0.6 mm dia. | |
| | | | NH | 150 to 1,500 mm | 0.5 mm dia. | |
| | | | NHB | NA | NA | |
| | | | NM | 150 to 1,500 mm | 1.9 mm dia. | |
| | | | NT | 150 to 1,500 mm | 0.5 mm dia. | |
| | | | NV | 150 to 1,500 mm | 0.5 mm dia. | |
| | | | NVG | NA | NA | |
| | | | VG | NA | NA | |
| Detect transpar- ent objects (polarized) | Compact threaded sensing head is easy to install; 25 mm bending radius. |  M6 threaded head Reflector E39-R3 2 m (6.56 ft) length | A | 10 to 250 mm | 0.3 mm dia. | E32-R21 +  E39-R3 |
| | | | DAN-HS | 10 to 250 mm | ----- | |
| | | | DAN-LD | 10 to 250 mm | ----- | |
| | | | DAN-SM | 10 to 250 mm | 0.1 mm dia. | |
| | | | F | 20 to 230 mm | 0.5 mm dia. | |
| | | | H | 10 to 250 mm | 0.3 mm dia. | |
| | | | NH | 10 to 250 mm | 0.3 mm dia. | |
| | | | NHB | NA | NA | |
| | | | NM | 25 to 250 mm | 0.6 mm dia. | |
| | | | NT | 25 to 250 mm | 0.3 mm dia. | |
| | | | NV | 25 to 250 mm | 0.3 mm dia. | |
| | | | NVG | NA | NA | |
| | | | VG | NA | NA | |

■ BLOCK STYLE FIBER-OPTIC AMPLIFIERS

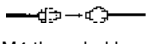
The following tables show the detection distance for selected fiber-optic cables in combination with Omron block style amplifiers. These amplifiers offer specialized capabilities to solve particular application problems.

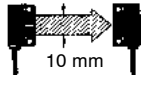

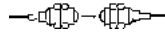





■ E3MC-(M)Y RGB COLOR SENSOR

Through-beam Fiber-optic Cables

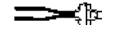
| Application | Features | Appearance | Detection distance (see note) | Part number |
|-----------------|--|---|-------------------------------|--|
| General purpose | Compact threaded head; 25 mm bending radius; 1 mm ID fiber |  M4 threaded head x 14 mm (0.55 in) L 2 m (6.56 ft) length | 30 mm | E32-TC200  |
| Long distance | Compact M4, head, 1 mm ID fiber; 25 mm bending radius; 1.4 mm ID fiber |  M4 threaded head x 11 mm (0.43 in) L 2 m (6.56 ft) length | 60 mm | E32-T11L  |
| Area sensing | 10 mm wide beam, long sensing distance; 25 mm bending radius; 1 mm ID fiber |  10 mm 2 m (6.56 ft) length | 200 mm | E32-T16  |
| Long distance | M14 with magnifying lens extends sensing distance; ideal for explosion-proof applications; 25 mm bending radius; 1 mm ID fiber |  M14 threaded head x 23 mm (0.91 in) L 10 m (32.8 ft) length | 1,100 mm | E32-T17L  |

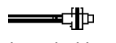
Note: The E3MC-(M)Y discriminates red, blue, and yellow films at the above distances.

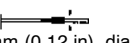









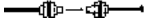

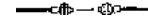

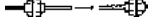



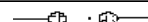

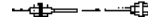
Diffuse Fiber-optic Cables

| Application | Features | Appearance | Detection distance (see note) | Part number |
|----------------------------|--|--|-------------------------------|--|
| High precision positioning | Concentric beam: emitter in the center and a ring of 16 receivers in the 2.5 mm dia. tip; 25 mm bending radius; 1 mm ID fiber; coaxial diffuse |  M6 threaded head x 20 mm (0.79 in) L 2 m (6.56 ft) length | 5 mm | E32-CC200  |
| General purpose | Compact threaded head; 25 mm bending radius; 1 mm ID fiber |  M6 threaded head x 14 mm (0.55 in) L 2 m (6.56 ft) length | 5 mm | E32-DC200  |
| Long distance | Compact threaded sensing head; 25 mm bending radius; 1 mm ID fiber |  M6 threaded head x 17 mm (0.67 in) L 2 m (6.56 ft) length | 5 mm | E32-D11L  |
| Precise positioning | Concentric beam: light source in the center with a ring of 16 receivers in 3 mm dia. tip; 25 mm bending radius; coaxial diffuse |  3 mm (0.12 in) dia. x 15 mm (0.59 in) L 2 m (6.56 ft) length | 4.5 mm | E32-D32L  |

Note: The E3MC-(M)Y discriminates eleven colors at the above distances. For a typical example, nine colors are discriminated at a sensing distance of 12 mm.

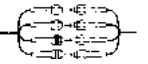

■ E3XA-CC4A ANALOG FIBER-OPTIC AMPLIFIER

Through-beam Fiber-optic Cables





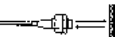









| Application | Features | Appearance | Detection distance | Min. detectable object | Part number |
|---------------------|--|--|--------------------|------------------------|--|
| General purpose | Compact threaded head; 25 mm bending radius; 1 mm ID fiber |  M4 threaded head x 14 mm (0.55 in) L 2 m (6.56 ft) length | 80 mm (600 mm*) | 0.2 mm dia. | E32-TC200  |
| General purpose | M3; possible to mount the reflective side-view conversion attachment (E39-F5); 25 mm bending radius; 1 mm ID fiber |  M3 threaded head x 12.5 mm (0.49 in) L 2 m (6.56 ft) length | 80 mm | 0.2 mm dia. | E32-TC200A  |
| Thin probe | Probe for space-confined sensing areas; 25 mm bending radius; 1 mm ID fiber |  M4 threaded head 90 mm (3.54 in) probe length 2 m (6.56 ft) length | 80 mm | 0.2 mm dia. | E32-TC200B  |
| Thin probe | Probe for space-confined sensing areas; 25 mm bending radius; 1 mm ID fiber |  M4 threaded head 40 mm (1.57 in) probe length 2 m (6.56 ft) length | 80 mm | 0.2 mm dia. | E32-TC200B4  |
| General purpose | M3; suitable for detecting minute objects; 25 mm bending radius; 0.5 mm ID fiber |  M3 threaded head x 11 mm (0.43 in) L 2 m (6.56 ft) length | 20 mm | 0.1 mm dia. | E32-TC200E  |
| Bendable probe | Sensing head with 90 mm probe; 25 mm bending radius |  M3 threaded head 90 mm (3.54 in) length probe 2 m (6.56 ft) length | 20 mm | 0.1 mm dia. | E32-TC200F  |
| Bendable probe | Sensing head with 90 mm probe; 25 mm bending radius |  M3 threaded head 40 mm (1.57 in) length probe 2 m (6.56 ft) length | 20 mm | 0.1 mm dia. | E32-TC200F4  |
| Long distance | Built-in lens provides long sensing distance; each sensing head has two 3.2 mm screw mounting holes; 25 mm bending radius; 1 mm ID fiber |  2 m (6.56 ft) length | 90 mm | 0.8 mm dia. | E32-T14  |
| Mark/edge detection | Ideal for mark sensing or belt alignment; no optical axis adjustment required; easy to mount; 1 mm ID fiber |  10 mm 2 m (6.56 ft) length | 10 mm | 0.8 mm dia. | E32-G14  |
| Area sensing | Multiple heads allow shape recognition; 0.5 mm ID fiber |  M3 threaded head x 11 mm (0.43 in) L 2 m (6.56 ft) length | 100 mm | 0.3 mm dia. | E32-M21  |

Note: *Value in parentheses represents the sensing distance of the fiber when the E39-F1 lens is attached to its tip.

Retroreflective Fiber-optic Cables with E3XA-CC4A Amplifier

| Application | Features | Appearance | Detection distance | Min. detectable object | Part number |
|--------------------------------------|---|---|--------------------|------------------------|---|
| Detect transparent and shiny objects | Compact threaded sensing head is easy to install. |  M6 threaded head Reflector E39-R3 2 m (6.56 ft) length | 30 to 200 mm | 0.3 mm dia. | E32-R21 + E39-R3  |

Diffuse Fiber-optic Cables with E3XA-CC4A Amplifier

| Application | Features | Appearance | Detection distance | Min. detectable object | Part number |
|-----------------|--|--|--------------------|------------------------|--|
| General purpose | Compact threaded head; 25 mm bending radius; 1 mm ID fiber |  M6 threaded head x 14 mm (0.55 in) L 2 m (6.56 ft) length | 30 mm | 0.03 mm dia. | E32-DC200  |
| General purpose | M3; possible to mount the reflective side-view conversion attachment (E39-F5); 25 mm bending radius; 1 mm ID fiber |  M6 threaded head x 20 mm (0.79 in) L 2 m (6.56 ft) length | 30 mm | 0.03 mm dia. | E32-CC200  |
| Thin probe | Probe for space-confined sensing areas; 25 mm bending radius; 1 mm ID fiber |  M6 threaded head 90 mm (3.54 in) probe length 2 m (6.56 ft) length | 30 mm | 0.03 mm dia. | E32-DC200B  |
| Thin probe | Probe for space-confined sensing areas; 25 mm bending radius; 1 mm ID fiber |  M6 threaded head 40 mm (1.57 in) probe length 2 m (6.56 ft) length | 30 mm | 0.03 mm dia. | E32-DC200B4  |
| General purpose | M3; suitable for detecting minute objects; 25 mm bending radius; 0.5 mm ID fiber |  M3 threaded head x 11 mm (0.43 in) L 2 m (6.56 ft) length | 7 mm | 0.03 mm dia. | E32-DC200E  |
| Thin probe | Sensing head with 90 mm probe; 25 mm bending radius; 0.5 mm ID fiber |  M3 threaded head 90 mm (3.54 in) length probe 2 m (6.56 ft) length | 7 mm | 0.03 mm dia. | E32-DC200F  |
| Thin probe | Sensing head with 40 mm probe; 25 mm bending radius; 0.5 mm ID fiber |  M3 threaded head 40 mm (1.57 in) length probe 2 m (6.56 ft) length | 7 mm | 0.03 mm dia. | E32-DC200F4  |

■ E3JU-X LIMIT SWITCH STYLE (IR LED)

Armored Through-beam Fiber-optic Cables

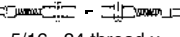
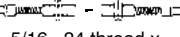



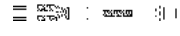
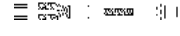



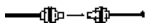

| Application | Features | Appearance | Detection distance | Min. detectable object | Part number |
|-----------------|---|---|--------------------|------------------------|---------------------|
| General purpose | Can withstand temperatures to 200°C (392°F) |  5/16- 24 thread x 38.1 mm (1.5 in) L 0.91 m (3 ft) length | 400 mm | 0.25 mm dia. | E32-UTBT1-3F |
| General purpose | Can withstand temperatures to 200°C (392°F) |  5/16- 24 thread x 38.1 mm (1.5 in) L 1.83 m (6 ft) length | 400 mm | 0.25 mm dia. | E32-UTBT1-6F |

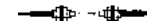
Armored Diffuse Fiber-optic Cables

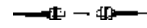

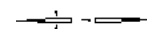

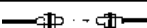

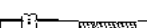
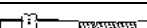





| Application | Features | Appearance | Detection distance | Min. detectable object (gold wire) | Part number |
|-----------------|---|--|--------------------|------------------------------------|---------------------|
| General purpose | Can withstand temperatures to 200°C (392°F) |  5/16 - 24 thread x 38.1 mm (1.5 in) L 0.91 m (3 ft) length | 90 mm | 0.05 mm dia. | E32-UDBT1-3F |
| General purpose | Can withstand temperatures to 200°C (392°F) |  5/16 - 24 thread x 38.1 mm (1.5 in) L 1.83 m (6 ft) length | 80 mm | 0.05 mm dia. | E32-UDBT1-6F |

■ E3JU-XR LIMIT SWITCH STYLE (RED LED)

Through-beam Fiber-optic Cables

| Application | Features | Appearance | Detection distance | Min. detectable object | Part number |
|----------------------------------|---|--|--------------------|------------------------|--|
| General purpose | Compact threaded head; 25 mm bending radius; 1 mm ID fiber |  M4 threaded head x 14 mm (0.55 in) L 2 m (6.56 ft) length | 200 mm | 0.2 mm dia. | E32-TC200  |
| Flexible, resists breaking | Ideal for mounting on moving section; 4 mm bending radius; 1.5 mm ID fiber |  M4 threaded head x 11.7 mm (0.46 in) L 2 m (6.56 ft) length | 135 mm | 0.5 mm dia. | E32-T11  |
| | Compact M3 head ideal for mounting on moving sections; 4 mm bending radius; 0.5 mm ID fiber |  M3 threaded head x 11 mm (0.43 in) L 2 m (6.56 ft) length | 39 mm | 0.2 mm dia. | E32-T21  |
| Minute objects | 2 mm dia. head fits in space- confined areas; 25 mm bending radius; 0.5 mm ID fiber |  2 mm dia. (0.8 in) x 22 mm (0.87 in) 2 m (6.56 ft) length | 50 mm | 0.2 mm dia. | E32-T22  |
| Heat resistant | Resists 150°C; fiber sheath material: fluoro-resin. Operating ambient temperature: -40°C to 150°C (-40°F to 302°F); 35 mm bending radius; 1.5 mm ID fiber |  M4 threaded head x 17 mm (0.67 in) L 2 m (6.56 ft) length | 150 mm | 1.0 mm dia. | E32-T51  |
| General purpose | Armored glass fiber-optic cable can withstand tempera- tures to 200°C (392°F) |  5/16-24 thread x 38.1 mm (1.5 in) L 0.91 m (3 ft) length | 200 mm | 0.2 mm dia. | E32-UTAT1-3F |
| General purpose | Armored glass fiber-optic cable can withstand tempera- tures to 200°C (392°F) |  5/16-24 thread x 38.1 mm (1.5 in) L 1.83 m (6 ft) length | 170 mm | 0.2 mm dia. | E32-UTAT1-6F |

Diffuse Fiber-optic Cables with E3JU-XR Amplifiers

| Application | Features | Appearance | Detection distance | Min. detectable object | Part number |
|-----------------|--|--|--------------------|------------------------|--|
| General purpose | Compact threaded head; 25 mm bending radius; 1 mm ID fiber |  M6 threaded head x 14 mm (0.55 in) L 2 m (6.56 ft) length | 75 mm | 0.015 mm dia. | E32-DC200  |
| General purpose | Compact threaded head; 4 mm bending radius; 0.25 mm ID fiber |  M6 threaded head x 17 mm (0.67 in) L 2 m (6.56 ft) length | 45 mm | 0.03 mm dia. | E32-D11  |
| General purpose | Compact threaded head; 4 mm bending radius; 0.25 mm ID fiber |  M3 threaded head x 11 mm (0.43 in) L 2 m (6.56 ft) length | 7 mm | 0.03 mm dia. | E32-D21  |
| General purpose | Compact threaded head; 25 mm bending radius; 0.25 mm ID fiber; coaxial |  2 mm (0.08 in) dia. x 15 mm (0.59 in) tip; 29 mm (1.14 in) L overall 2 m (6.56 ft) length | 18 mm | 0.03 mm dia. | E32-D32  |
| Heat resistant | Resists 150°C; fiber sheath material: fluoro-resin. Operating ambient temperature: -40°C to 150°C (-40°F to 302°F); 35 mm bending radius; 1.5 mm ID fiber |  M6 threaded head 2 m (6.56 ft) length | 60 mm | 0.03 mm dia. | E32-D51  |
| General purpose | Armored glass fiber-optic cable can withstand temperatures to 150°C (302°F) |  5/16-24 thread x 38.1 mm (1.5 in) L 0.91 m (3 ft) length | 80 mm | 0.03 mm dia. | E32-UDAT1-3F |
| General purpose | Armored glass fiber-optic cable can withstand temperatures to 150°C (302°F) |  5/16-24 thread x 38.1 mm (1.5 in) L 1.83 m (6 ft) length | 65 mm | 0.03 mm dia. | E32-UDAT1-6F |











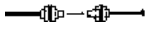

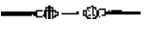

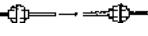
■ E3A2-X AND E3S-X3 BLOCK STYLE AMPLIFIERS

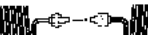
The table specifies the sensing characteristics of each fiber when used with the following amplifiers:



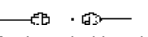

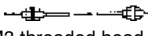







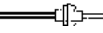

A2X: E3A2-X Slim Amplifier with Plug-in Output

SX3: E3S-X3 Rugged Metal Body DC Amplifier

Through-beam Fiber-optic Cables

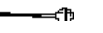
| Application | Features | Appearance | Type | Detection distance | Min. detectable object (opaque) | Part number |
|-----------------|--|---|------|--------------------|---------------------------------|--|
| General purpose | Compact threaded head; 25 mm bending radius; 1 mm ID fiber |  M4 threaded head x 14 mm (0.55 in) L 2 m (6.56 ft) length | A2X | 120 mm | 1.0 mm dia. | E32-TC200  |
| | | | SX3 | | | |
| General purpose | M3; possible to mount the reflective side view conversion attachment (E39-F5); 25 mm bending radius; 1 mm ID fiber |  M3 threaded head x 7 mm (0.28 in) L 2 m (6.56 ft) length | A2X | 120 mm | 1.0 mm dia. | E32-TC200A  |
| | | | SX3 | | | |
| Thin probe | Probe for space-confined sensing areas; 25 mm bending radius; 1 mm ID fiber |  M4 threaded head 90 mm (3.54 in) probe length 2 m (6.56 ft) length | A2X | 120 mm | 1.0 mm dia. | E32-TC200B  |
| | | | SX3 | | | |
| General purpose | Coiled cable ideal for moving parts; 25 mm bending radius; 1 mm ID fiber |  M4 threaded head x 11 mm (0.43 in) L 56.5 cm (1.85 ft) L; 2 m (6.56 ft) extended | A2X | 100 mm | 1.0 mm dia. | E32-TC200C  |
| | | | SX3 | | | |
| Thin probe | Sensing head with 90 mm probe; spiral coiled cable with-stands repeated stretching from reciprocating machine parts; 25 mm bending radius; 1 mm ID fiber |  M4 threaded head 90 mm (3.54 in) probe length 56.6 cm (1.85 ft); 2 m (6.56 ft) extended | A2X | 100 mm | 1.0 mm dia. | E32-TC200D  |
| | | | SX3 | | | |
| General purpose | Thin fiber with small easy-to-mount head.; 25 mm bending radius; 0.5 mm ID fiber |  M3 threaded head x 11 mm (0.43 in) L 2 m (6.56 ft) length | A2X | 35 mm | 0.5 mm dia. | E32-TC200E  |
| | | | SX3 | | | |
| Thin probe | Sensing head with 90 mm probe; 25 mm bending radius; 0.5 mm ID fiber |  M3 threaded head 90 mm (3.54 in) length probe 2 m (6.56 ft) length | A2X | 35 mm | 0.5 mm dia. | E32-TC200F  |
| | | | SX3 | | | |

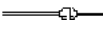
Diffuse Fiber-optic Cables for E3A2-X and E3S-X3 Amplifiers

| Application | Features | Appearance | Type | Detection distance | Standard object (see note) | Part number |
|---------------------------|--|---|------|--------------------|-------------------------------|--|
| High accuracy positioning | Concentric beam: emitter in the center and a ring of 16 receivers in the 2.5 mm dia. tip; 25 mm bending radius; 1 mm ID fiber |  M6 threaded head x 20 mm (0.79 in) L 2 m (6.56 ft) length | A2X | 50 mm | 30 x 30 mm | E32-CC200  |
| | | | SX3 | | | |
| General purpose | Compact threaded head; 25 mm bending radius; 1 mm ID fiber |  M6 threaded head x 14 mm (0.55 in) L 2 m (6.56 ft) length | A2X | 50 mm | 30 x 30 mm | E32-DC200  |
| | | | SX3 | | | |
| Thin probe | Probe for space-confined sensing areas; 25 mm bending radius; 1 mm ID fiber |  M6 threaded head 90 mm (3.54 in) probe length 2 m (6.56 ft) length | A2X | 50 mm | 30 x 30 mm | E32-DC200B  |
| | | | SX3 | | | |
| General purpose | Coiled cable ideal for moving parts; 25 mm bending radius; 1 mm ID fiber |  M6 threaded head x 17 mm (0.67 in) L 64 cm (2.1 ft) L coiled; 2 m (6.56 ft) extended. | A2X | 15 mm | 30 x 30 mm | E32-DC200C  |
| | | | SX3 | | | |
| Thin probe | Sensing head with 90 mm probe; spiral coiled cable with stands repeated stretching from reciprocating machine parts; 25 mm bending radius; 1 mm ID fiber |  M6 threaded head 90 mm (3.54 in) probe length 64 cm (2.1 ft) L coiled; 2 m (6.56 ft) extended | A2X | 15 mm | 30 x 30 mm | E32-DC200D  |
| | | | SX3 | | | |
| General purpose | Thin fiber with small easy-to-mount head.; 25 mm bending radius; 0.5 mm ID fiber |  M3 threaded head x 11 mm (0.43 in) L 2 m (6.56 ft) length | A2X | 12 mm | 15 x 15 mm | E32-DC200E  |
| | | | SX3 | | | |
| Thin probe | Sensing head with 90 mm probe; 25 mm bending radius; 0.5 mm ID fiber |  M3 threaded head 90 mm (3.54 in) length probe 2 m (6.56 ft) length | A2X | 12 mm | 15 x 15 mm | E32-DC200F  |
| | | | SX3 | | | |

Note: A standard object for the diffuse fiber-optic cables is a Kodak 90% reflectance white card.

Specifications

■ THROUGH-BEAM FIBER-OPTIC CABLES

| Part number | Operating ambient temperature | Operating relative humidity | Permissible bending radius | Core material | Sheath material | Enclosure rating | |
|------------------------------|---|---------------------------------|---|---|--|------------------|------------|
| E32-T11 | -40°C to 70°C (-40°F to 158°F) with no icing | 35% to 85% with no condensation | 4 mm min. | PMMA | Vinyl chloride | IEC IP67 | |
| E32-T11L | | | 25 mm min. | | Black polyethylene | | |
| E32-T11R | | | 1 mm min. | | Copolymer vinyl chloride | | |
| E32-T12L | | | 25 mm min. | | Black polyethylene | | |
| E32-T17L | | | 25 mm min. | | Black polyethylene | | |
| E32-T21 | | | 4 mm min. | | Vinyl chloride | | |
| E32-T21L | | | 25 mm min. | | Black polyethylene | | |
| E32-T21R | | | 1 mm min. | | Copolymer vinyl chloride | | |
| E32-T22 | | | 25 mm min. | | Black polyethylene | | |
| E32-T22L | | | 25 mm min. | | Black polyethylene | | |
| E32-TC50 E32-TC200 | | | 25 mm min. | | Black polyethylene | | |
| E32-TC200A | | | 25 mm min. | | Black polyethylene | | |
| E32-TC200C | | | 25 mm min. | | Black polyethylene | | |
| E32-TC200E | | | 25 mm min. | | Black polyethylene | | |
| E32-TC500 E32-TC1000 | | | 25 mm min. | | Black polyethylene | | |
| E32-UTAT1-3F E32-UTAT1-6F | | | -40°C to 150°C (-40°F to 302°F) with no icing | | 35% to 85% with no condensation | | 25 mm min. |
| E32-UTBT1-3F E32-UTBT1-6F | -40°C to 200°C (-40°F to 392°F) with no icing | 25 mm min. | Glass | SUS 303 head, SUS 304 sheath | | | |
| E32-T33-1 | -40°C to 70°C (-40°F to 158°F) with no icing | 35% to 85% with no condensation | 25 mm min. | PMMA | Black polyethylene, stainless steel head | IEC IP67 | |
| E32-TC200B E32-TC200B4 | | | 25 mm min. | | Black polyethylene | | |
| E32-TC200D E32-TC200D4 | | | 25 mm min. | | Black polyethylene | | |
| E32-TC200F E32-TC200F4 | | | 25 mm min. | | Black polyethylene | | |
| E32-T14 | | | 25 mm min. | | Black polyethylene | | |
| E32-T14L | | | 25 mm min. | | Black polyethylene | | |
| E32-T16 | | | 25 mm min. | | Black polyethylene | | |
| E32-T16P | | | 10 mm min. | | Vinyl chloride | | IEC IP50 |
| E32-T24 | | | 25 mm min. | | Black polyethylene | | IEC IP67 |
| E32-T51* | | | -40°C to 150°C (-40°F to 302°F) with no icing | | 35 mm min. | | PMMA |
| E32-T61 | -40°C to 300°C (-40°F to 572°F) with no icing | 25 mm min. | Glass | 304 stainless steel | IEC IP67 | | |
| E32-G14 | -40°C to 70°C (-40°F to 158°F) with no icing | 35% to 85% with no condensation | 25 mm min. | PMMA | Black polyethylene | IEC IP67 | |
| E32-M21 | | | 25 mm min. | | Black polyethylene | | |
| E32-T12F | -30°C to 70°C (-22°F to 158°F) with no icing | 40 mm min. | | Teflon [®] -covered black polyethylene | IEC IP67 | | |

*When used continuously between -40°C and 130°C (-40°F and 266°F)

Teflon is a registered trademark of the Dupont Company and the Mitsui Dupont Chemical Company for their fluoride resin.

■ THROUGH-BEAM FIBER-OPTIC CABLES (CONTINUED)

| Part number | Operating ambient temperature | Operating relative humidity | Permissible bending radius** | Core material | Sheath material | Enclosure rating |
|-------------|---|---------------------------------|------------------------------|---------------|--------------------------|------------------|
| E32-T22S* | -40°C to 70°C (-40°F to 158°F) with no icing | 35% to 85% with no condensation | 10 mm min. | PMMA | Copolymer vinyl chloride | IEC IP67 |
| E32-T24S* | | | 25 mm min. | Glass | 304 stainless steel | |
| E32-T84S* | -40°C to 200°C (-40°F to 392°F) with no icing | | | | | |

*13 mm dia. beam size at a distance of 200 mm

**Average at 30% of sensing distance

■ DIFFUSE FIBER-OPTIC CABLES*

| Part number | Operating ambient temperature | Operating relative humidity | Permissible bending radius | Core material | Sheath material | Enclosure rating |
|----------------------------|---|---------------------------------|---|---------------|------------------------------|------------------|
| E32-CC200 | -40°C to 70°C (-40°F to 158°F) with no icing | 35% to 85% with no condensation | 25 mm min. | PMMA | Black polyethylene | IEC IP67 |
| E32-D11 | | | 4 mm min. | | Vinyl chloride | |
| E32-D11L | | | 25 mm min. | | Black polyethylene | |
| E32-D11R | | | 1 mm min. | | Copolymer vinyl chloride | |
| E32-D21 | | | 4 mm min. | | Vinyl chloride | |
| E32-D21L | | | 25 mm min. | | Black polyethylene | |
| E32-D21R | | | 1 mm min. | | Black polyethylene | |
| E32-D22L | | | 25 mm min. | | Black polyethylene | |
| E32-D32 | | | | | | |
| E32-D32L | | | | | | |
| E32-DC50, E32-DC200 | | | | | | |
| E32-DC200C | | | | | | |
| E32-DC200E | | | | | | |
| E32-DC500, E32-DC1000 | | | | | | |
| E32-UDAT1-3F, E32-UDAT1-6F | | | -40°C to 150°C (-40°F to 302°F) with no icing | | | |
| E32-UDBT1-3F, E32-UDBT1-6F | -40°C to 200°C (-40°F to 392°F) with no icing | | 25 mm min. | Glass | SUS 303 head, SUS 304 sheath | |
| E32-D33 | -40°C to 70°C (-40°F to 158°F) with no icing | | 25 mm min. | PMMA | Black polyethylene | |
| E32-DC200B, E32-DC200B4 | | | | | | |
| E32-DC200D, E32-DC200D4 | | | | | | |
| E32-DC200F, E32-DC200F4 | | | | | | |
| E32-DC9G, E32-DC9G4 | | | 12.5 mm min. | | Stainless steel | |
| E32-D14L | | | 25 mm min. | | Black polyethylene | |
| E32-D24 | | | 25 mm min. | | Black polyethylene | |
| E32-D51** | | | -40°C to 150°C (-40°F to 302°F) with no icing | | | 35 mm min. |

*Differential travel is 20% of max. detection distance. With E3X-H11 amplifier, this is adjustable between 0% and 20%.

**When used continuously between -40°C and 130°C (-40°F and 266°F)

■ DIFFUSE FIBER-OPTIC CABLES (CONTINUED)*

| Part number | Operating ambient temperature | Operating relative humidity | Permissible bending radius | Core material | Sheath material | Enclosure rating |
|-------------|---|---------------------------------|---|---------------|---|------------------|
| E32-D61 | -40°C to 300°C (-40°F to 572°F) with no icing | 35% to 85% with no condensation | 25 mm min. | Glass | 304 stainless steel | IEC IP67 |
| E32-D73 | -40°C to 400°C (-40°F to 752°F) with no icing | | 25 mm min. | Glass | 304 stainless steel | IEC IP67 |
| E32-D12F | -30°C to 70°C (-22°F to 158°F) with no icing | 35% to 85% with no condensation | 40 mm min. | PMMA | Teflon [®] -covered black polyethylene | IEC IP67 |
| E32-L24L** | -40°C to 105°C (-40°F to 221°F) with no icing | | 10 mm min. (average 10% decrease in sensing distance) | PMMA | Reinforced polyethylene | IEC IP50 |
| E32-L25 | -40°C to 70°C (-40°F to 158°F) with no icing | | 25 mm min. | PMMA | Black polyethylene | IEC IP50 |
| E32-L25A | | | 25 mm min. | PMMA | Black polyethylene | IEC IP50 |
| E32-L25L** | -40°C to 105°C (-40°F to 221°F) with no icing | | 10 mm min. (average 10% decrease in sensing distance) | PMMA | Reinforced polyethylene | IEC IP50 |

*Differential travel is 20% of max. detection distance. With E3X-H11 amplifier, this is adjustable between 0% and 20%.

**Beam size is 2 mm dia.

Teflon is a registered trademark of the Dupont Company and the Mitsui Dupont Chemical Company for their fluoride resin.

■ POLARIZED RETROREFLECTIVE FIBER-OPTIC CABLES

| Part number | Operating ambient temperature | Operating relative humidity | Permissible bending radius | Core material | Sheath material | Enclosure rating |
|-------------------------------|--|-----------------------------|----------------------------|---------------|--------------------|------------------|
| E32-R16 with E39-R1 reflector | -25°C to 55°C (-13°F to 131°F) with no icing | 35% to 85% | 25 mm min. | PMMA | Black polyethylene | IEC IP66 |
| E32-R21 with E39-R3 reflector | -40°C to 70°C (-40°F to 158°F) with no icing | | | | | IEC IP67 |

Engineering Data

■ EXCESS GAIN RATIO

With standard sensing object. With standard target at maximum sensitivity.

E32-TC200 with E3X-DAN amplifier (Through-beam)

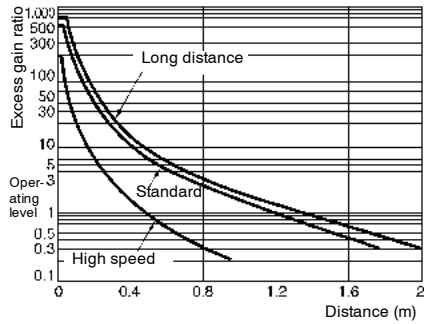

E32-DC200 with E3X-DAN amplifier (Reflective)

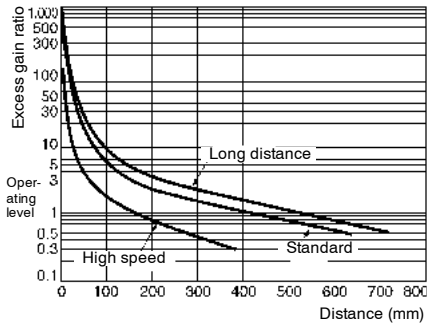

E32-D21L with E3X-DAN amplifier (Reflective)

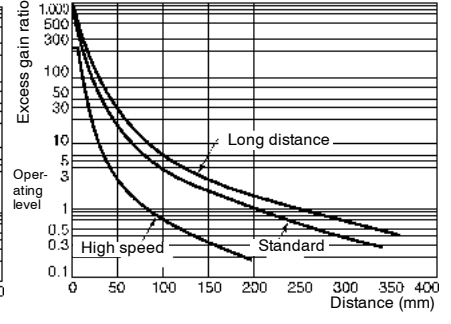

Through-beam Type, General Purpose

E32-T11 with E3X-A11 amplifier

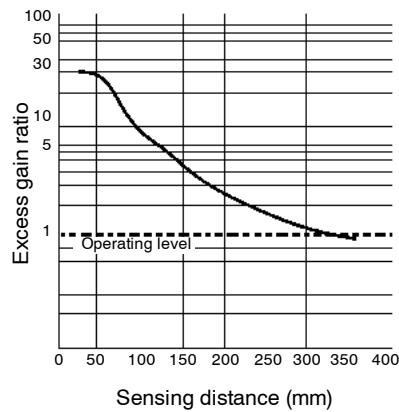

E32-T11 with E3JU-XR amplifier

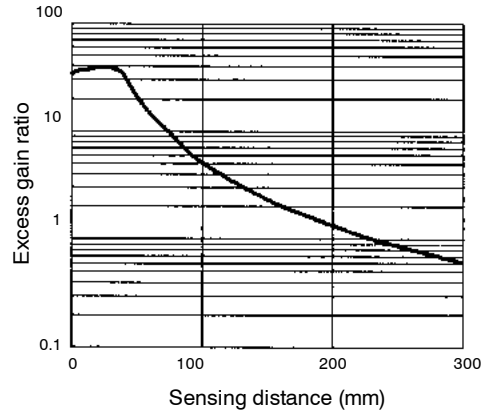

E32-T11L with E3X-A, E3X-F and E3X-VG amplifiers

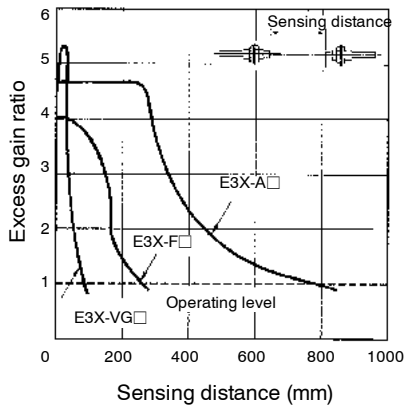

E32-T11L with E3X-H11 amplifier

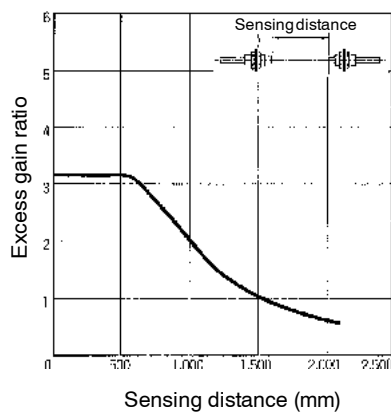

E32-T11L + E39-F1 with E3X-H11 amplifier

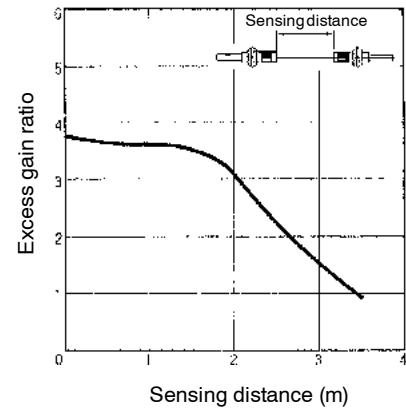

E32-T11L with E39-F2 and E3X-H11 amplifier

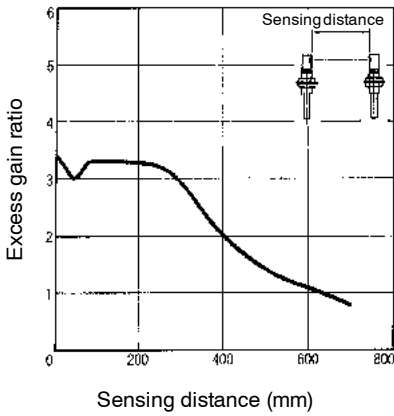

E32-T11L with E39-F3 and E3X-H11 amplifier

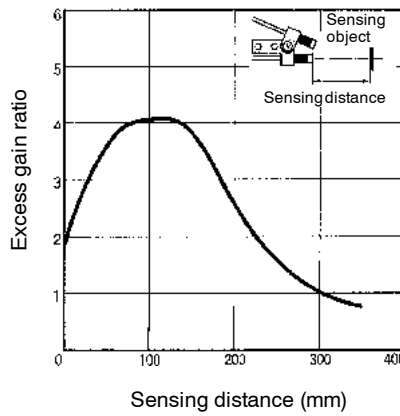

E32-T11L with E3X-NH amplifier

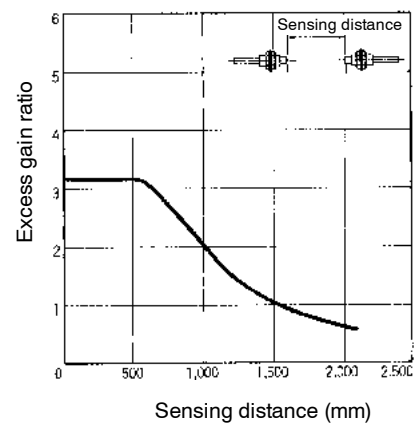

■ EXCESS GAIN RATIO (CONT.)

Through-beam Type, General Purpose

E32-T11L with E39-F1 and E3X-NH amplifier

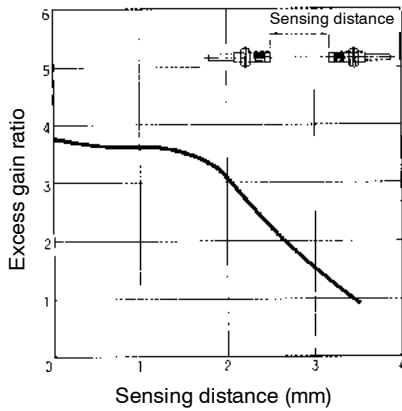

E32-T11R with E39-F2 and E3X-NH amplifier

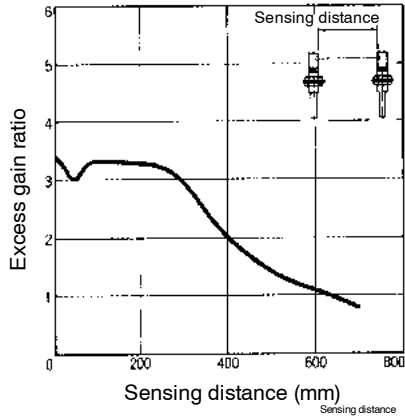

E32-T11L with E39-F3 and E3X-NH amplifier

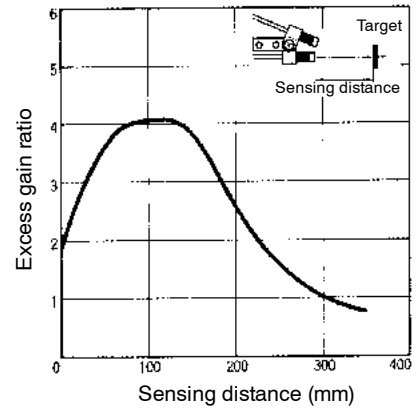

E32-T11L with E3X-NVG amplifier

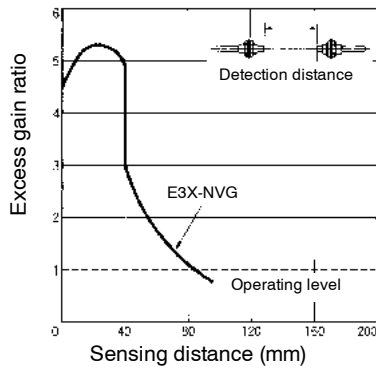

E32-T11R with E3X-NH amplifier

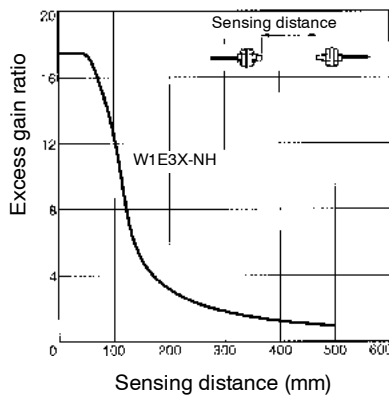

E32-T12L with E3X-A, E3X-F and E3X-VG amplifiers

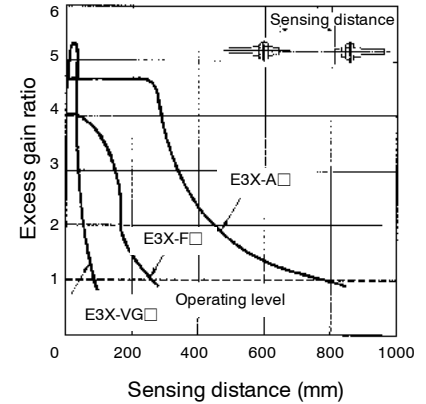

E32-T17L with E3X-A, E3X-F and E3X-VG amplifiers

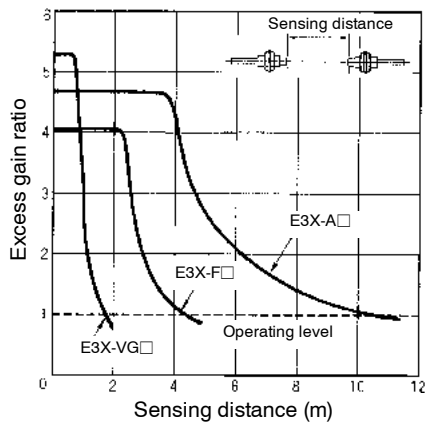

E32-T17L with E3X-H11 amplifier

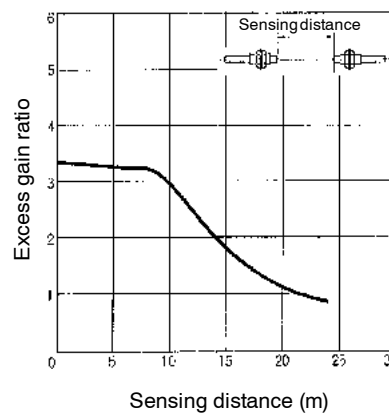

E32-T17L with E3X-NH amplifier

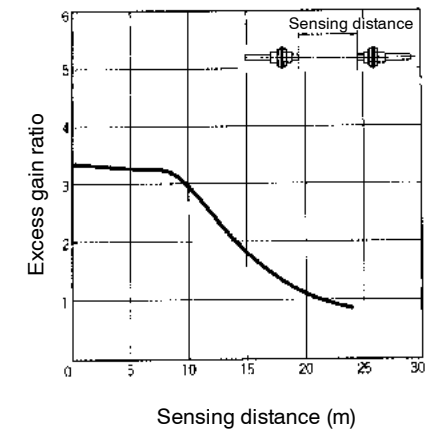

EXCESS GAIN RATIO (CONT.)

Through-beam Type, General Purpose

E32-T21 with E3X-A amplifier

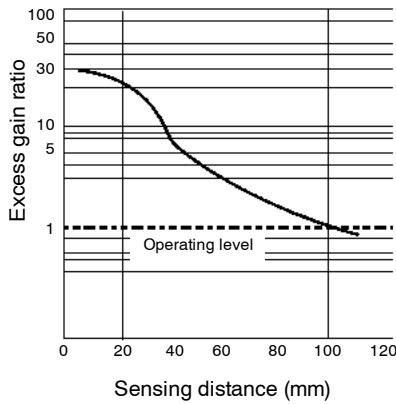

E32-T21 with E3JU-XR amplifier

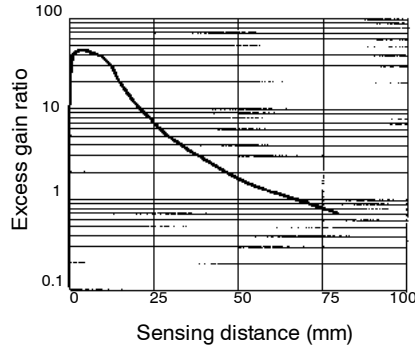

E32-T21 with E3X-H amplifier

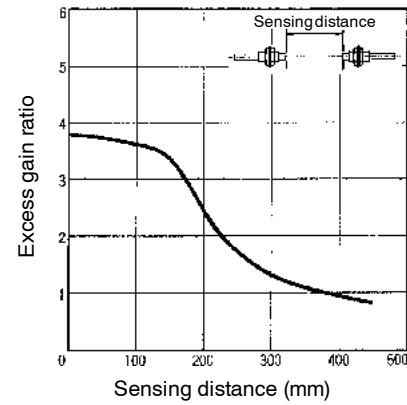

E32-T21L with E3X-A, E3X-F and E3X-VG amplifiers

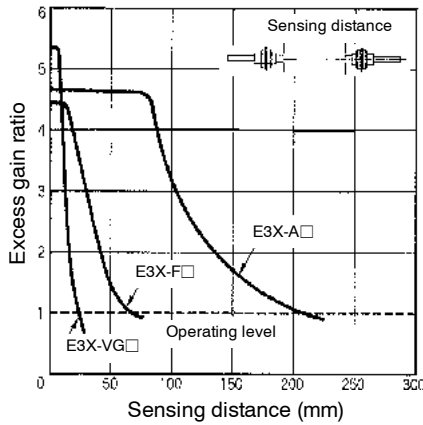

E32-T21L with E3X-NH amplifier

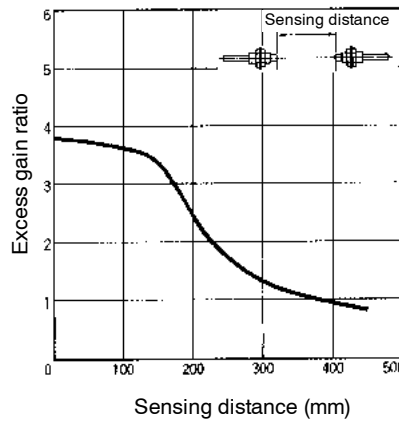

E32-T21R with E3X-NH amplifier

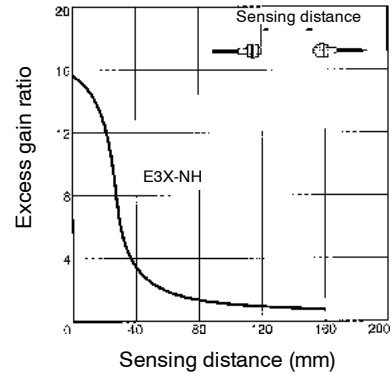

E32-T22 with E3X-A and E3S-X3 amplifiers

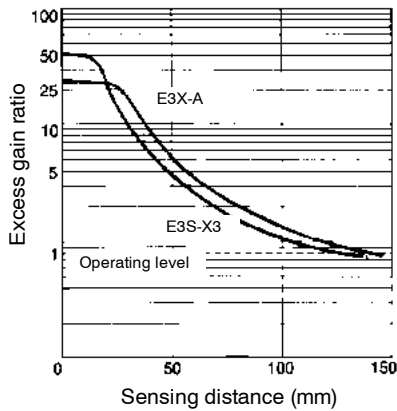

E32-T22 with E3JU-XR amplifier

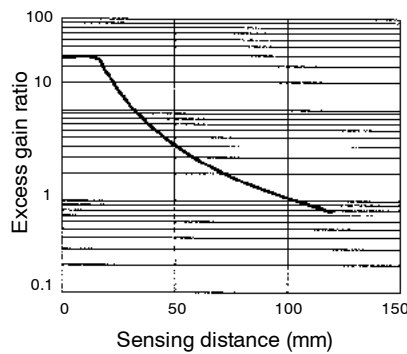

E32-T22L with E3X-A, E3X-F and E3X-VG amplifiers

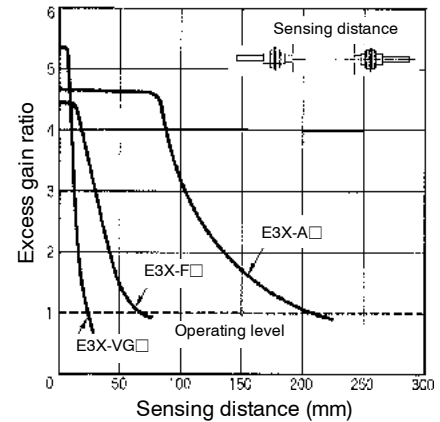

■ EXCESS GAIN RATIO (CONT.)

Through-beam Type, General Purpose

E32-TC50/TC200/TC500/TC1000 with E3X-A11 amplifier

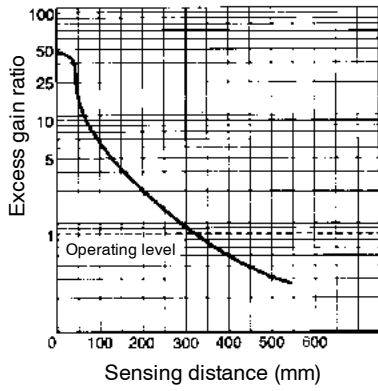

E32-TC200 with E39-F1 and E3X-A amplifier

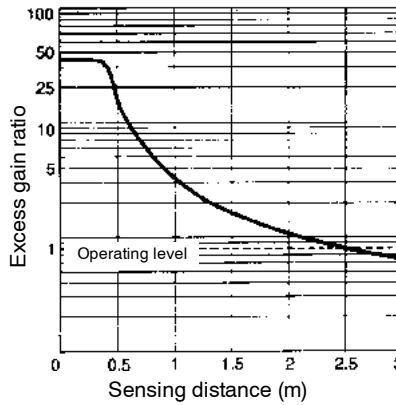

E32-TC200 with E39-F2 and E3X-A amplifier

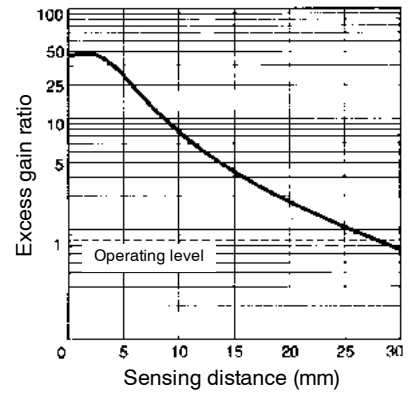

E32-TC200 with E3X-H11 amplifier

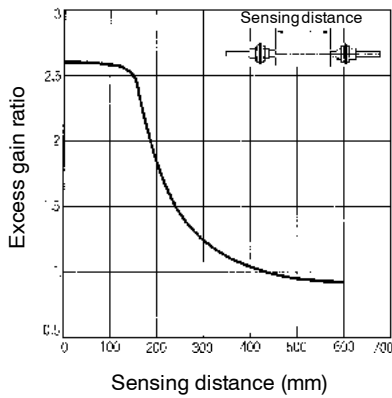

E32-TC200 with E39-F1 and E3X-H11 amplifier

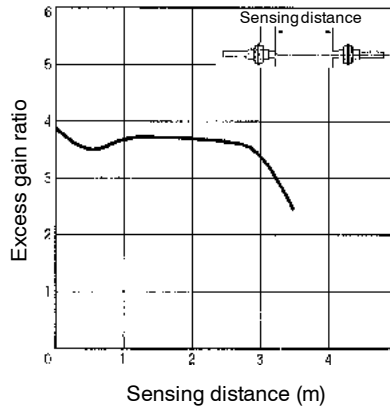

E32-TC200 with E3X-DA amplifier

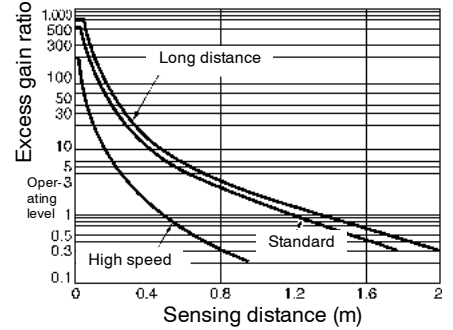

E32-TC200 with E3X-NM and E3X-NT amplifiers

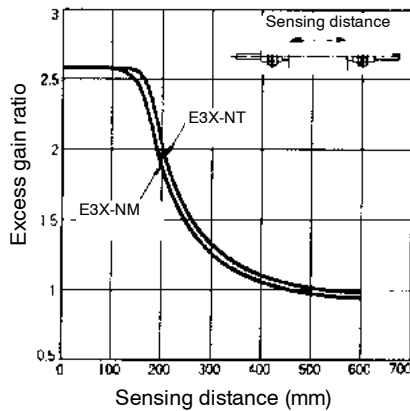

E32-TC200 with E3X-NH amplifier

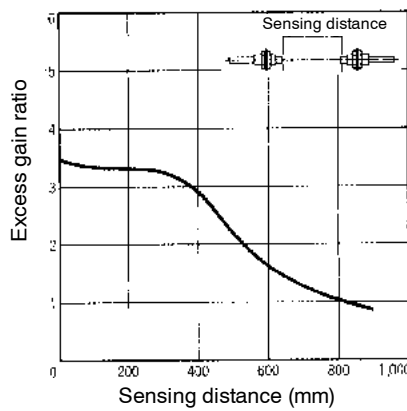

E32-TC200 with E39-F1 and E3X-NH amplifier

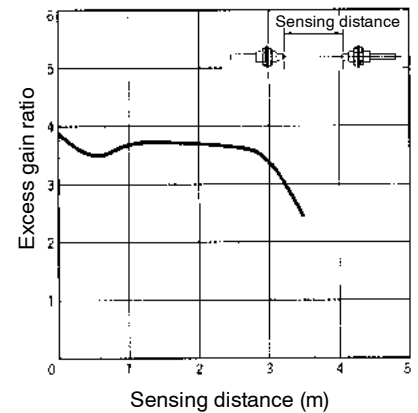

EXCESS GAIN RATIO (CONT.)

Through-beam Type, General Purpose

E32-TC200 with E3X-NV amplifier

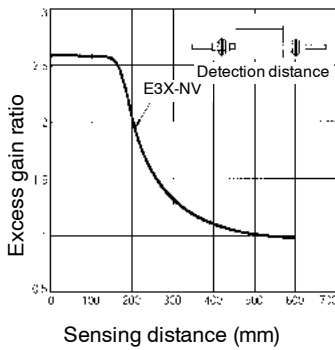

E32-TC200 with E3JU-XR amplifier

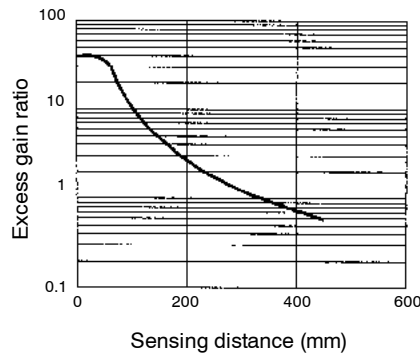

E32-TC200 with E3XA-CC4A analog output amplifier

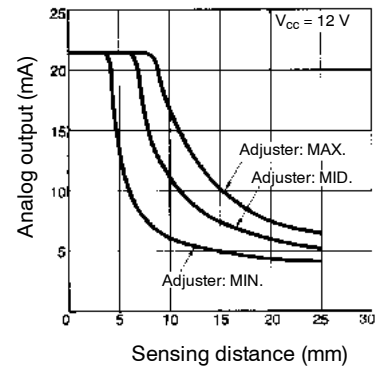

E32-TC200 with E3X-DA amplifier in analog mode

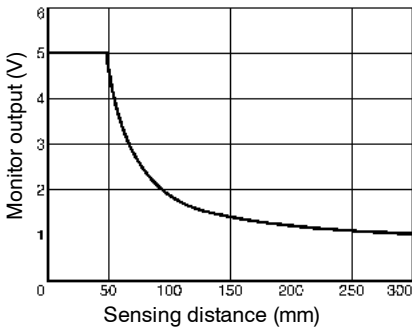

E32-TC200A with E3X-A11 amplifier

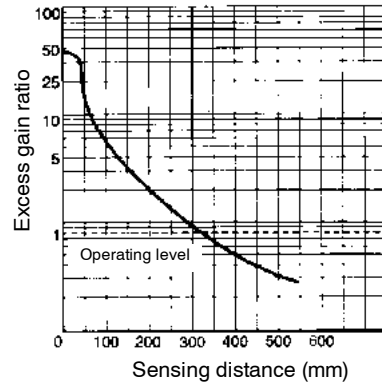

E32-TC200A with E3XA-CC4A analog output amplifier

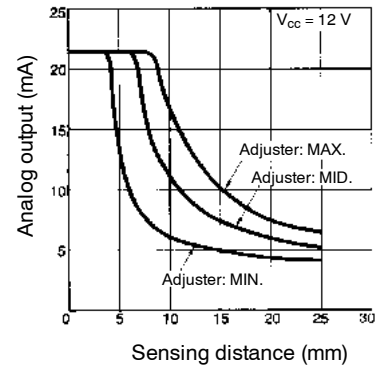

E32-TC200C with E3XA-CC4A analog output amplifier

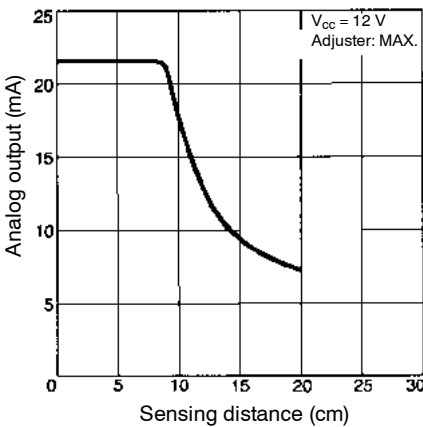

E32-TC200E with E3X-A11 amplifier

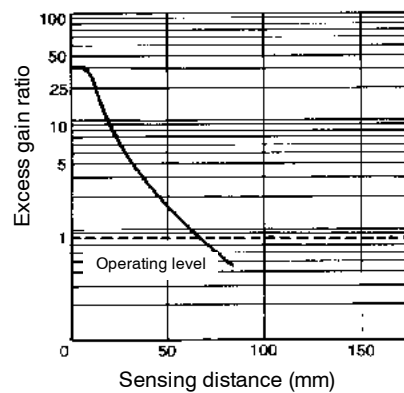

E32-TC200E with E3XA-CC4A analog output amplifier

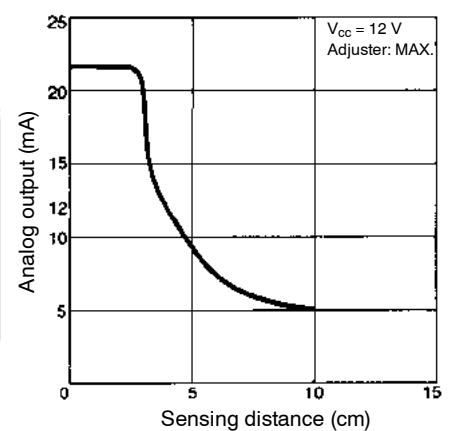

■ EXCESS GAIN RATIO (CONT.)

Through-beam, Armored Type

E32-UTAT1-3F with E3X-A11 amplifier

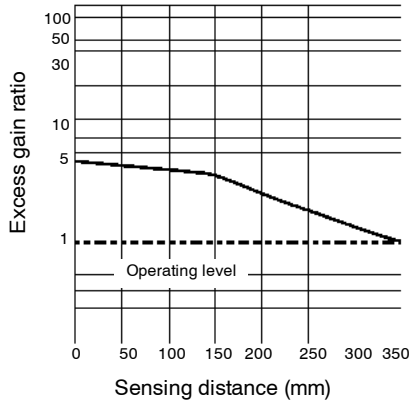

E32-UTAT1-3F with E3JU-XR amplifier

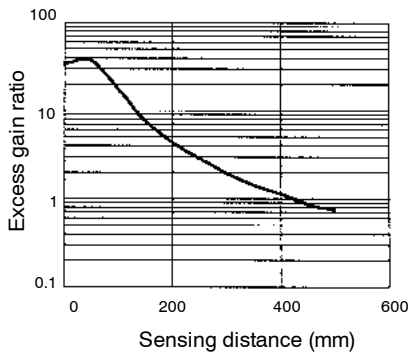

E32-UTAT1-6F with E3X-A11 amplifier

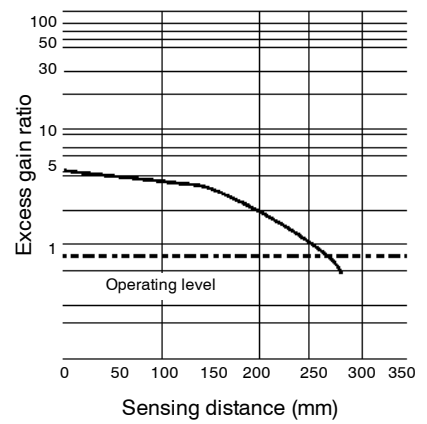

E32-UTAT1-6F with E3JU-XR amplifier

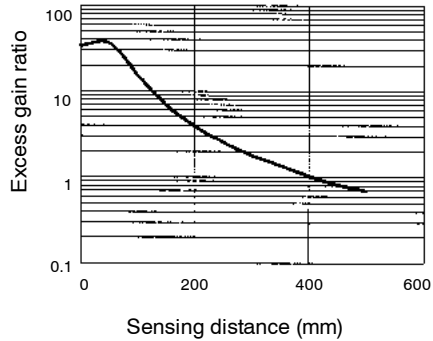

E32-UTBT1-3F with E3JU-X amplifier

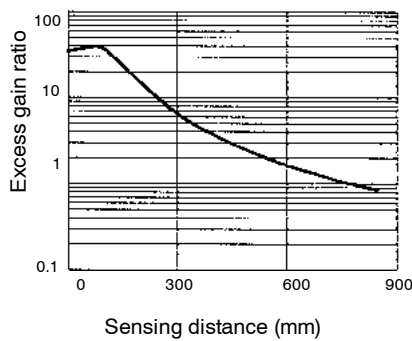

E32-UTBT1-6F with E3JU-X amplifier

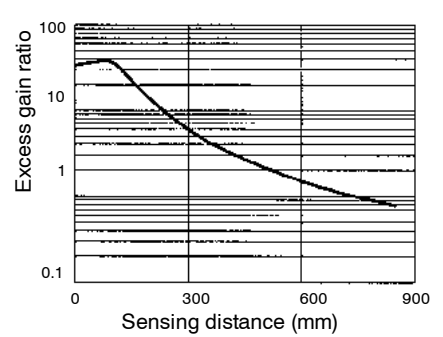

Through-beam, Probe Type

E32-TC200B/TC200B4 with E3X-A11 amplifier

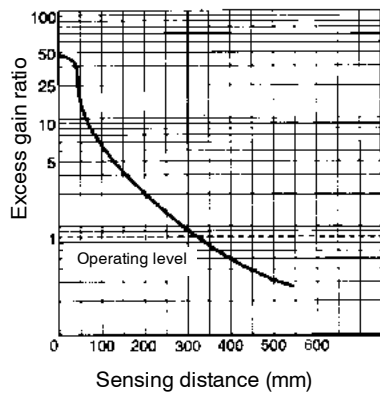

E32-TC200B with E3XA-CC4A analog output amplifier

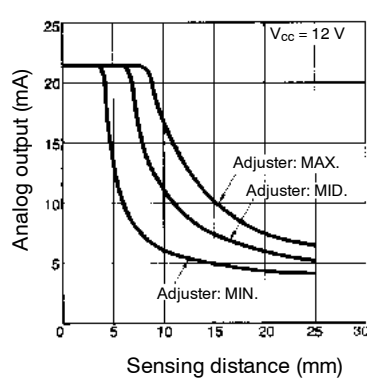

E32-TC200D with E3XA-CC4A analog output amplifier

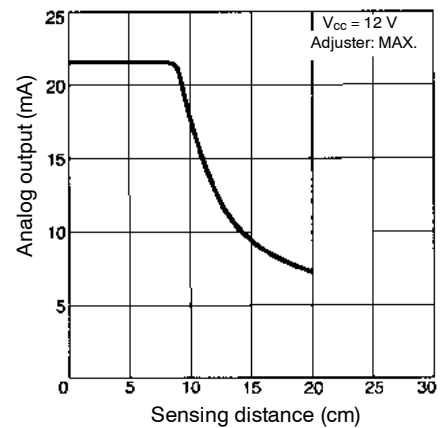

■ EXCESS GAIN RATIO (CONT.)

Through-beam, Probe Type

E32-TC200F/TC200F4 with E3X-A11 amplifier

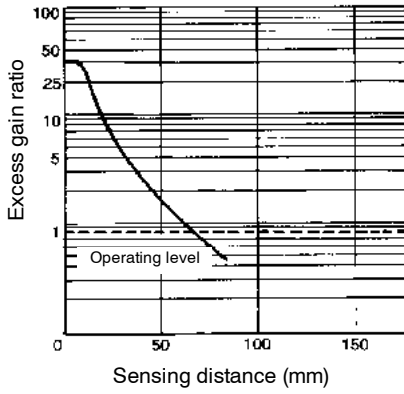

E32-TC200F with E3XA-CC4A analog output amplifier

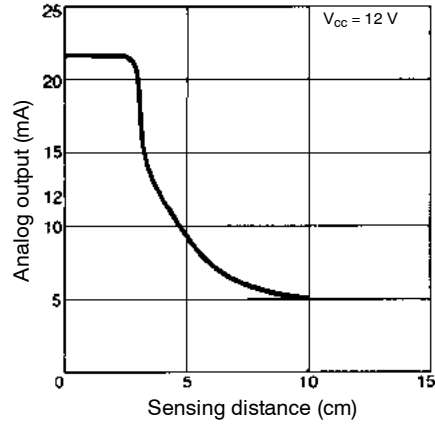

Through-beam, Side Beam Type

E32-T14 with E3X-A11 amplifier

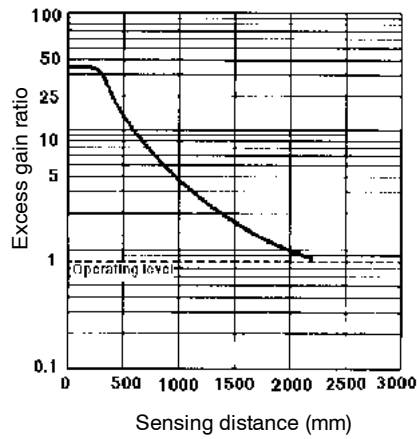

E32-T14L with E3X-A, E3X-F and E3X-VG amplifiers

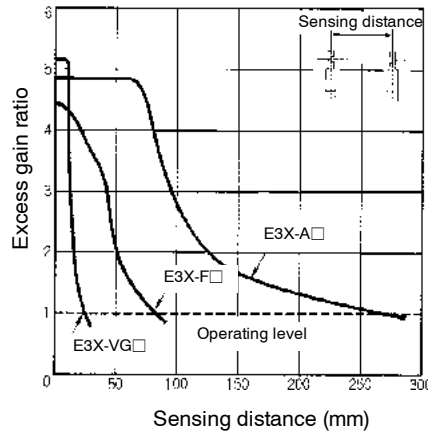

E32-T14L with E3X-H11 amplifier

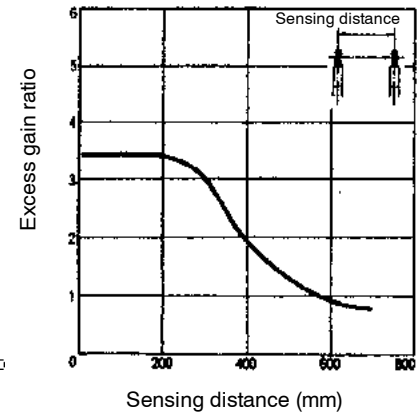

■ EXCESS GAIN RATIO (CONT.)

Through-beam, Side Sensing Type

E32-T14L with E3X-NH amplifier

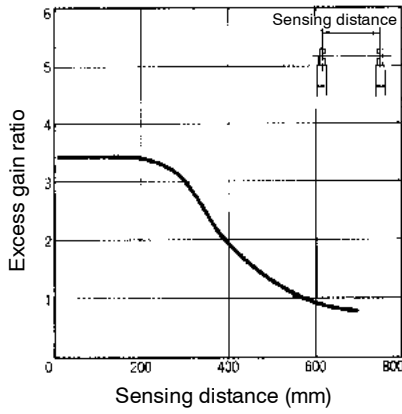

E32-T16 with E3X-A11 amplifier

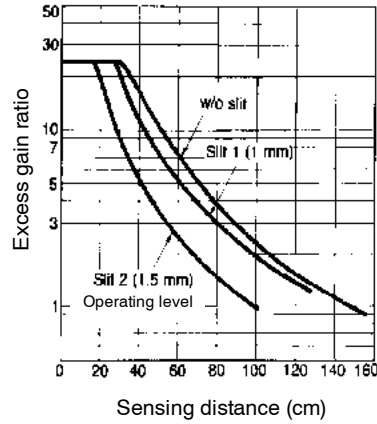

E32-T16 with E3X-NH amplifier

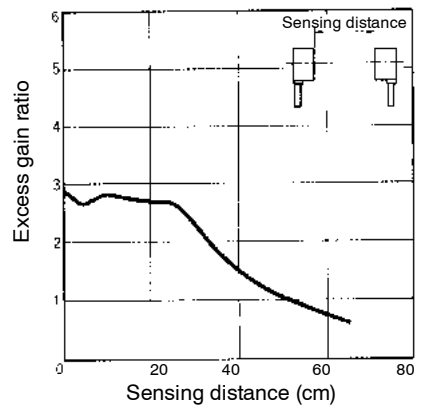

E32-T16 with E3X-H11 amplifier

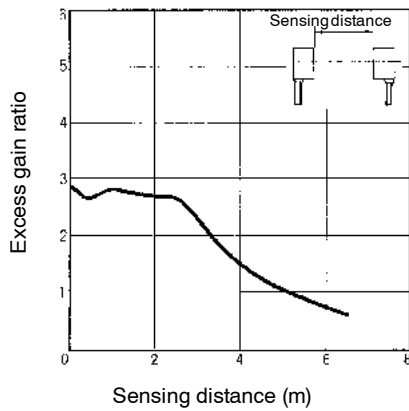

E32-T16 with E3XA-CC4A analog output amplifier

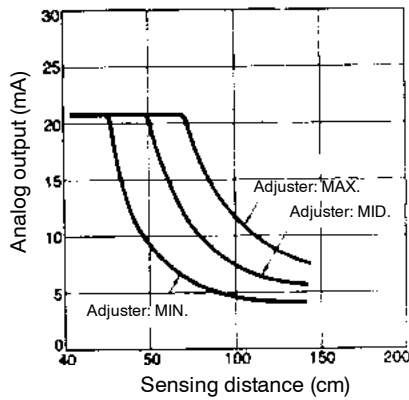

E32-T16 with slits and E3XA-CC4A amplifier

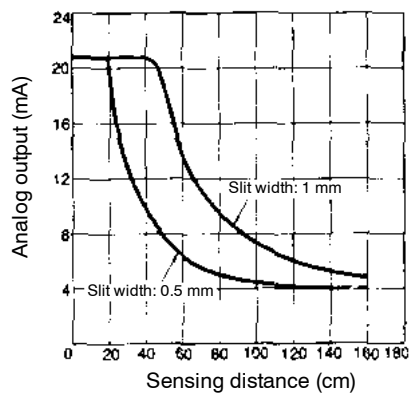

E32-T24 with E3X-A11 and E3S-X3 amplifiers

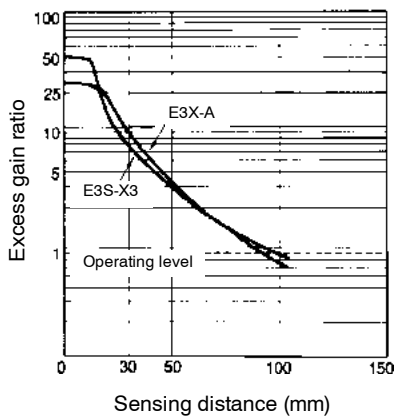

■ EXCESS GAIN RATIO (CONT.)

Through-beam, High Temperature Type

E32-T51 with E3X-A11 amplifier

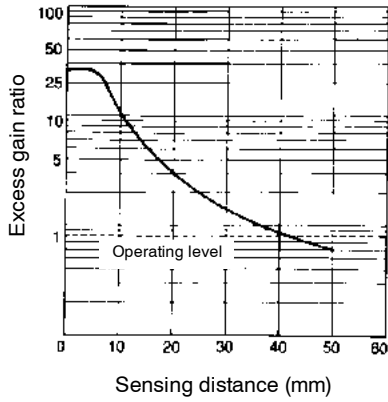

E32-T51 with E3X-NH amplifier

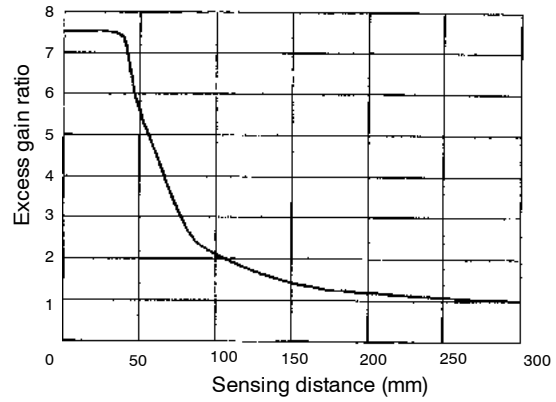

E32-T51 with E39-F1 and E3X-NH amplifier

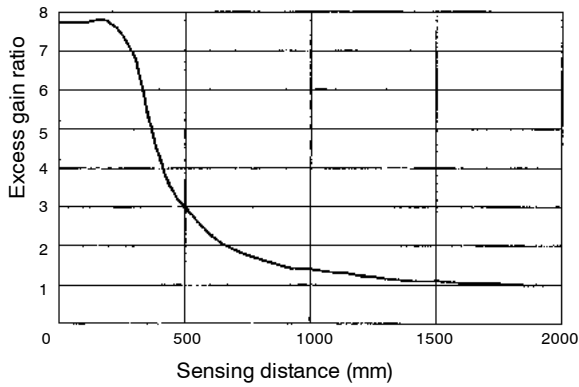

E32-T51 with E3JU-XR amplifier

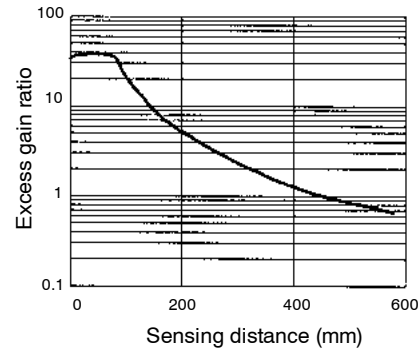

E32-T61 with E3X-A and E3S-X3 amplifiers

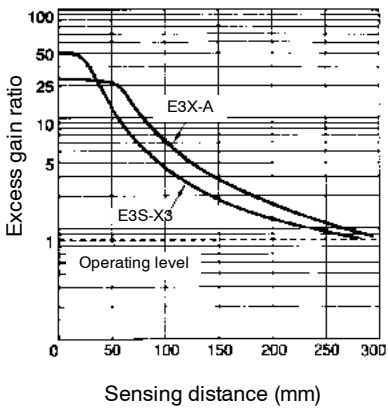

■ EXCESS GAIN RATIO (CONT.)

Through-beam, Special Purpose Type

E32-M21 with E3X-A11 amplifier

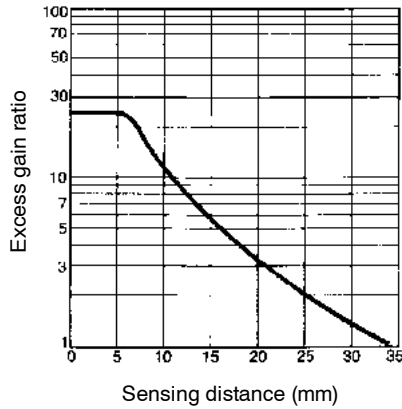

E32-M21 with E3XA-CC4A analog output amplifier

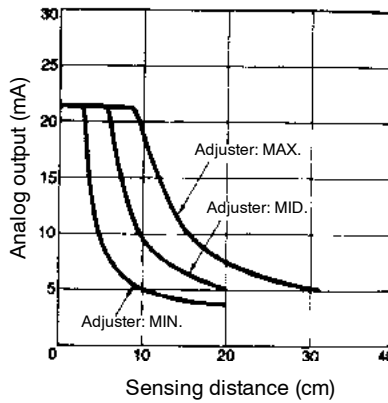

E32-T12F with E3X-A, E3X-F and E3X-VG amplifiers

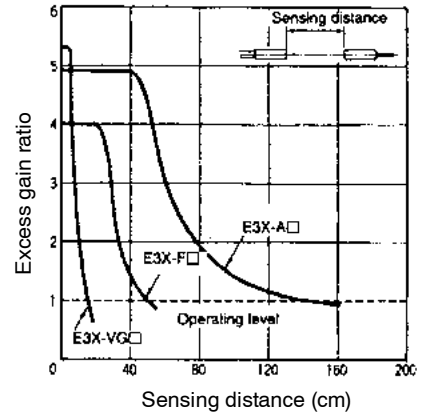

E32-T22S with E3X-NH amplifier

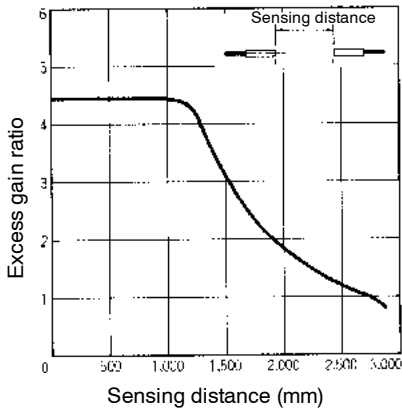

E32-T24S with E3X-NH amplifier

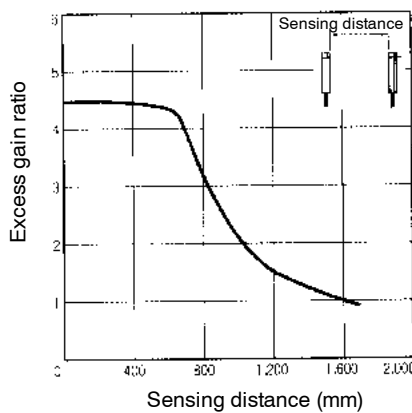

E32-T84S with E3X-NH amplifier

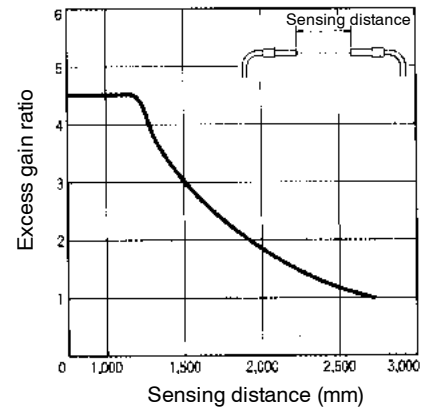

Diffuse, General Purpose

E32-CC200 with E3XA-CC4A analog output amplifier

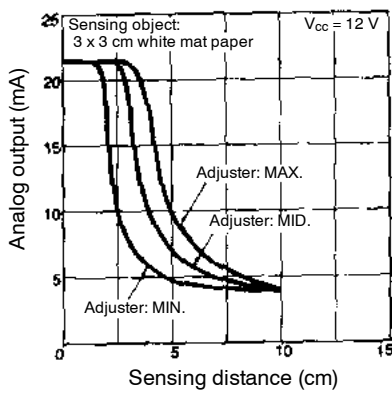

E32-D11 with E3X-A11 amplifier

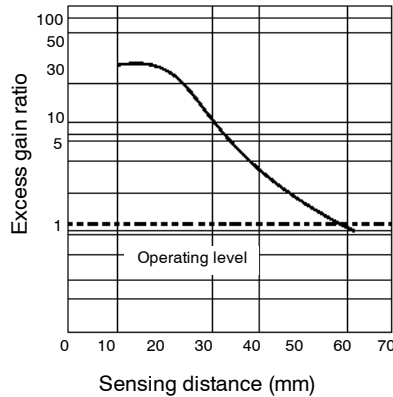

E32-D11 with E3JU-XR amplifier

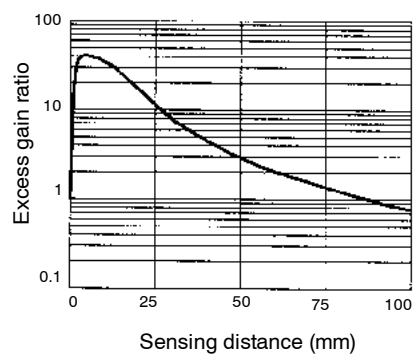

EXCESS GAIN RATIO (CONT.)

Diffuse, General Purpose

E32-D11L with E3X-A, E3X-F and E3X-VG amplifiers

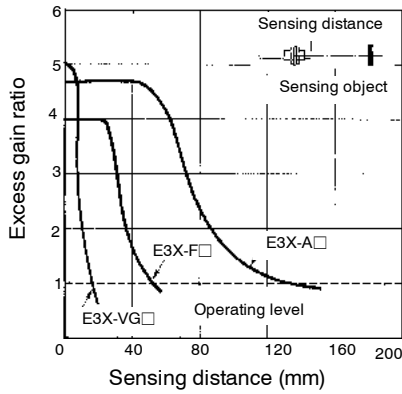

E32-D11L with E3X-H11 amplifier

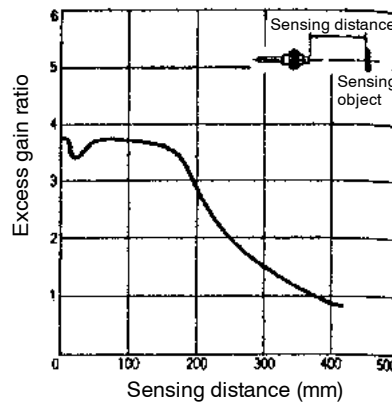

E32-D11L with E3X-NH amplifier

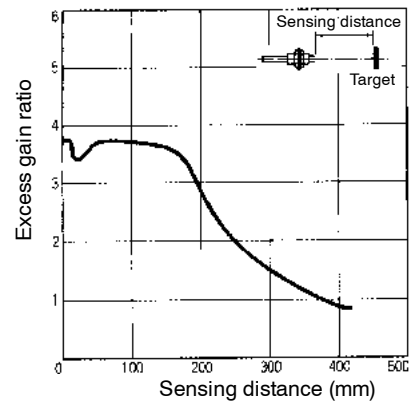

E32-D11L with E3X-NVG amplifier

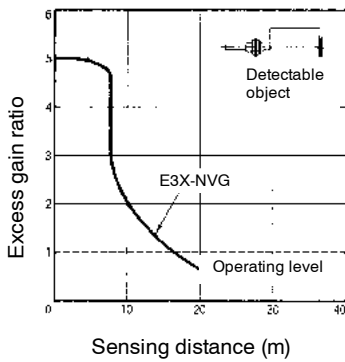

E32-D11L with E3X-H11 amplifier

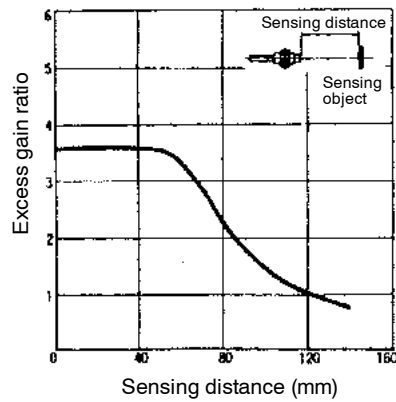

E32-D11R with E3X-NH amplifier

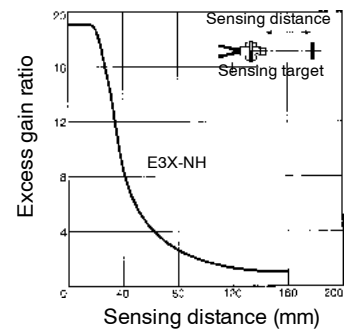

E32-D21 with E3X-A11 amplifier

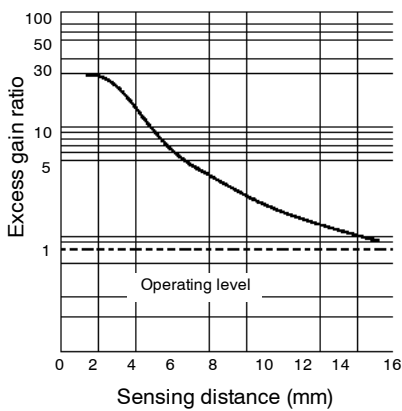

E32-D21 with E3JU-XR amplifier

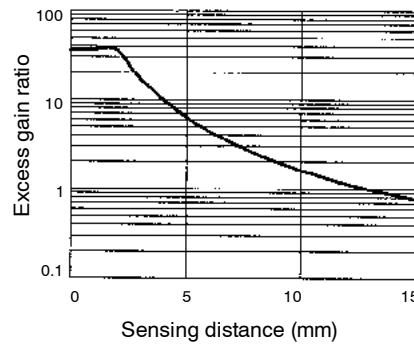

E32-D21L with E3X-A, E3X-F, and E3X-VG amplifiers

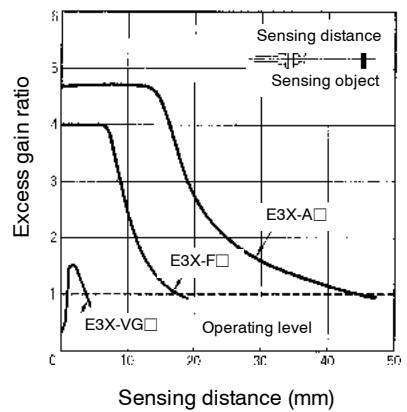

■ EXCESS GAIN RATIO (CONT.)

Diffuse, General Purpose

E32-D21L with E3X-DA amplifier

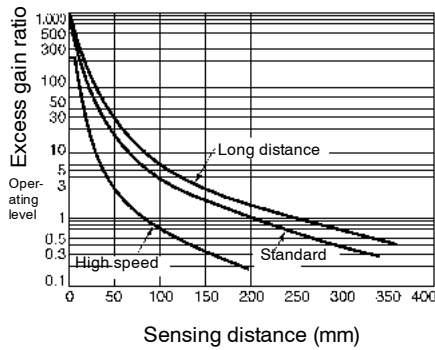

E32-D21L with E3X-NA amplifier

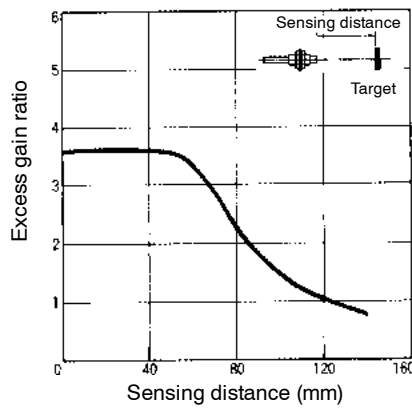

E32-D21R with E3X-NH amplifier

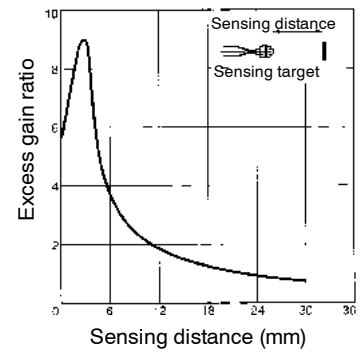

E32-D21L with E3X-A, E3X-F and E3X-V amplifiers

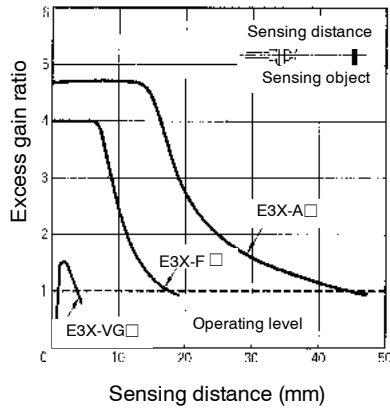

E32-D32 with E3X-A11 amplifier

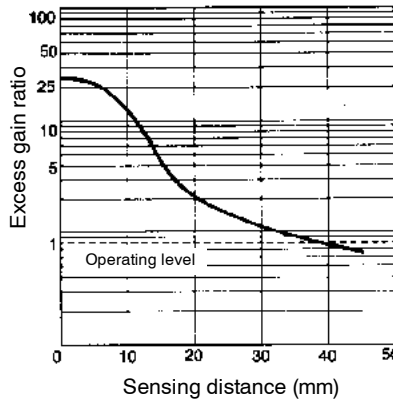

E32-D32 with E3JU-XR amplifier

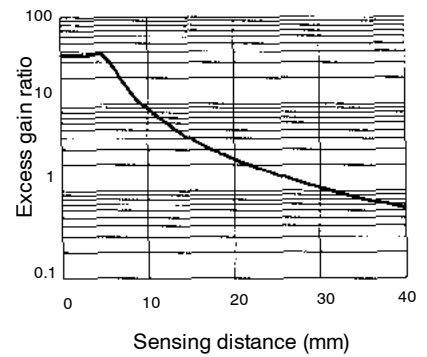

E32-DC50/DC200/DC500/DC1000 with E3X-A11 amplifier

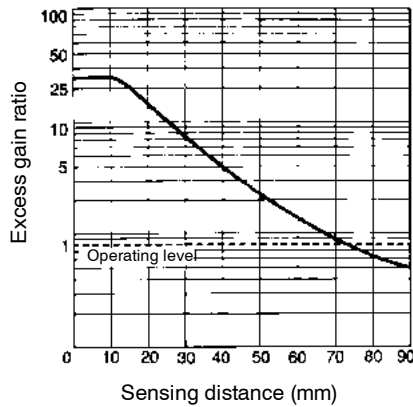

E32-DC200 with E3X-DA amplifier

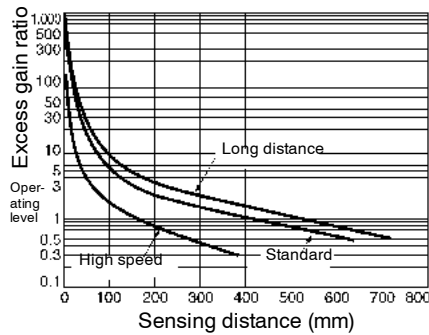

E32-DC200 with E3X-A11 amplifier

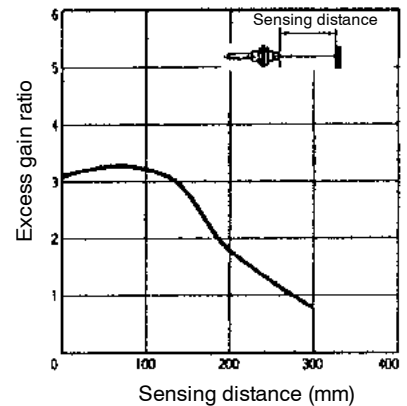

EXCESS GAIN RATIO (CONT.)

Diffuse, General Purpose

E32-DC200 with E3X-NM and E3X-NT amplifiers

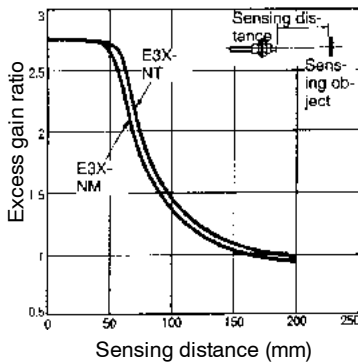

E32-DC200 with E3X-NH amplifier

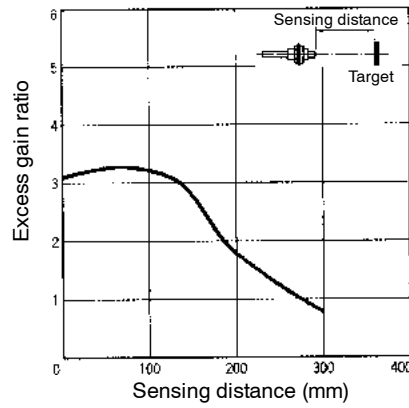

E32-DC200 with E3X-NV amplifier

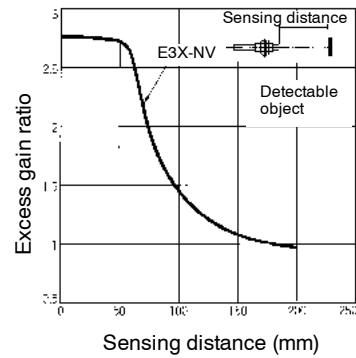

E32-DC200 with E3JU-XR amplifier

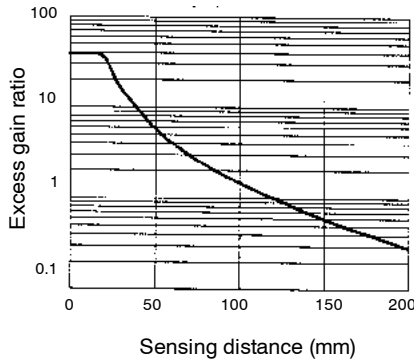

E32-DC200 with E3XA-CC4A analog output amplifier

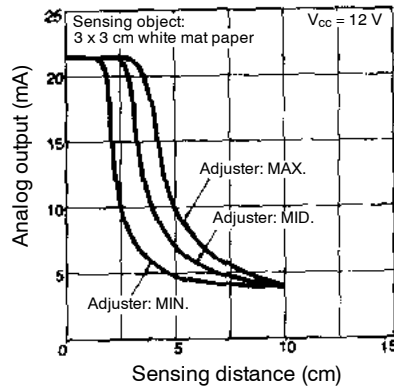

E32-DC200 with E3X-DA amplifier in analog mode

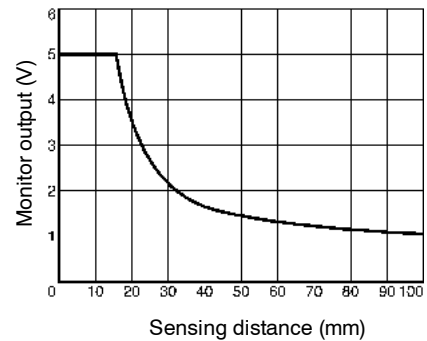

E32-DC200 with E3XA-CC4A analog output amplifier

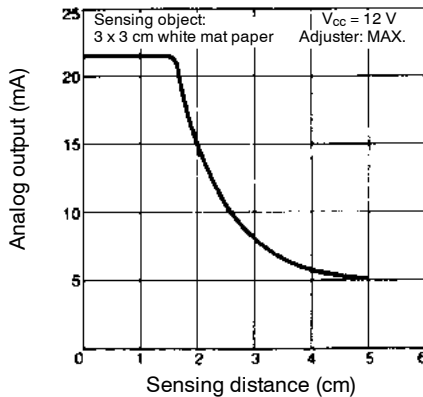

E32-DC200 with E3XA-CC4A analog output amplifier

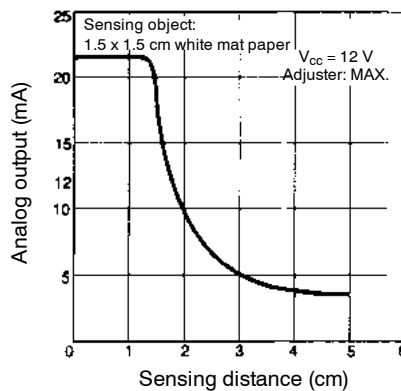

■ EXCESS GAIN RATIO (CONT.)

Diffuse, Armored Type

E32-JDAT1-3F with E3X-A11 amplifier

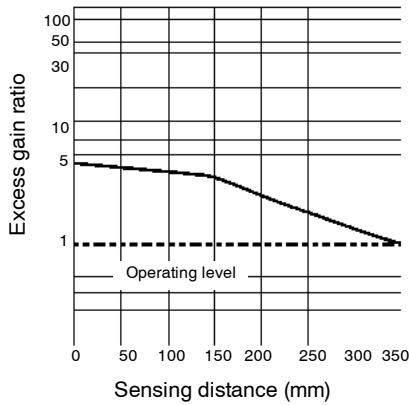

E32-JDAT1-3F with E3JU-XR amplifier

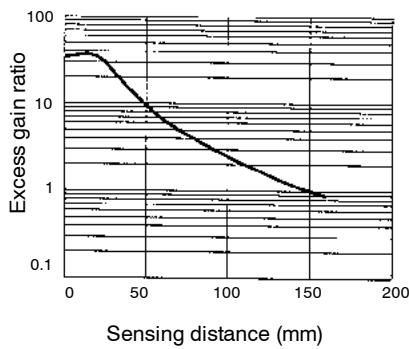

E32-JDAT1-6F with E3X-A11 amplifier

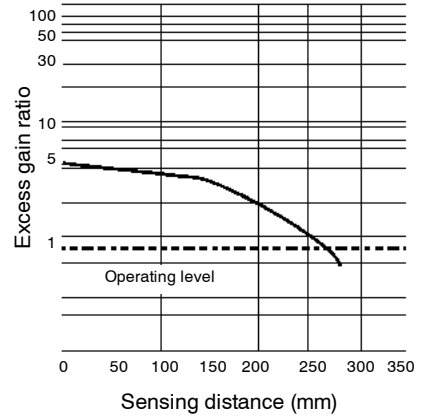

E32-JDAT1-6F with E3X-A11 amplifier

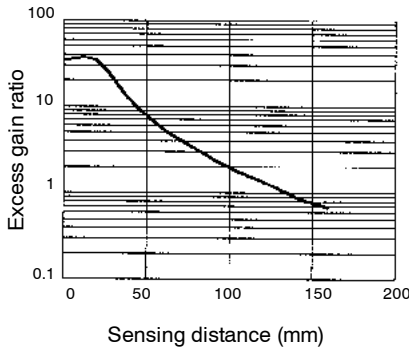

E32-JDBT1-3F with E3JU-X amplifier

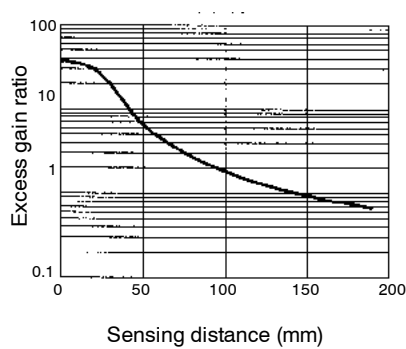

E32-JDBT1-6F with E3JU-X amplifier

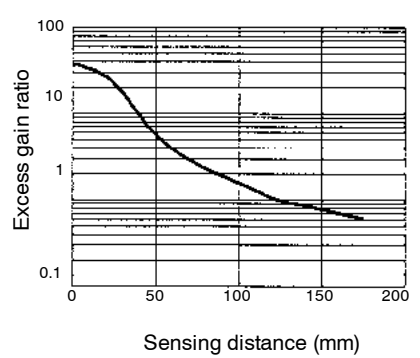

Diffuse, Probe Type

E32-D33 with E3X-A11 amplifier

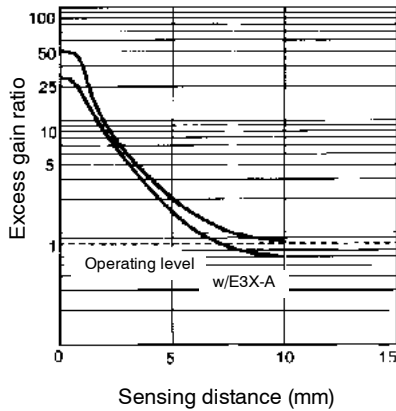

E32-DC200B/B4 with E3XA-CC4A analog amplifier

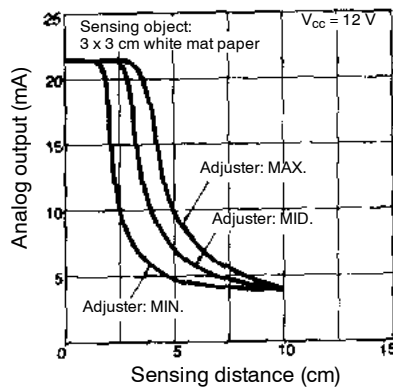

E32-DC200D/D4 with E3XA-CC4A analog amplifier

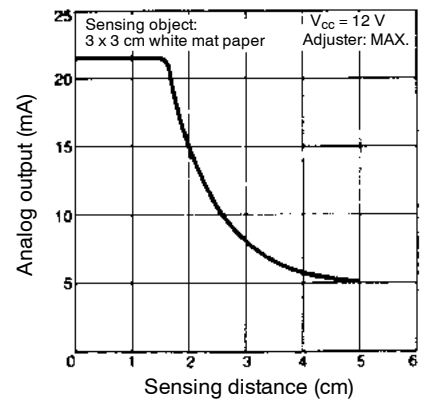

■ EXCESS GAIN RATIO (CONT.)

Diffuse, Probe Type

E32-DC200F/F4 with E3XA-CC4A analog amplifier

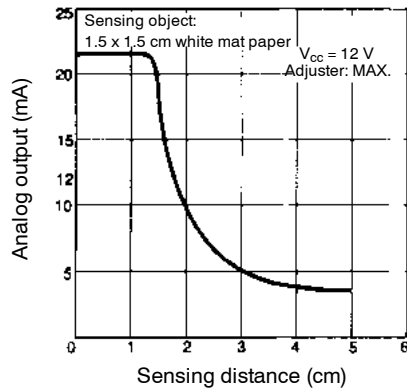

E32-DC9G/E32-DC9G4 with E3X-A11 amplifier

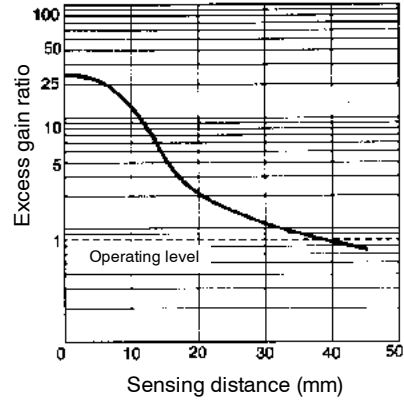

Diffuse, Side Sensing Type

E32-D14L with E3X-AE3X-F and E3X-VG amplifiers

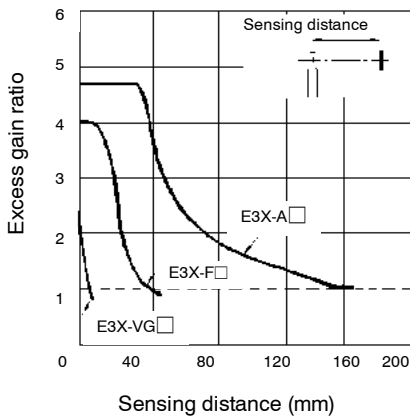

E32-D24 with E3X-A11 amplifier

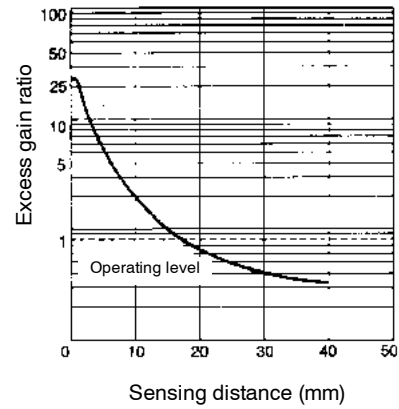

Diffuse, High Temperature Type

E32-D51 with E3X-A11 amplifier

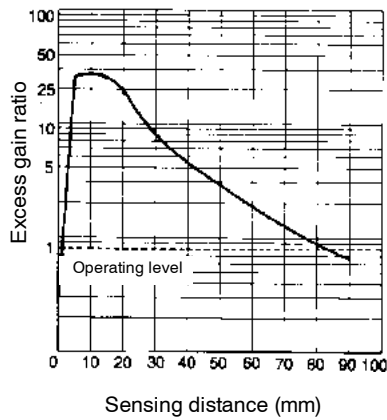

E32-D51 with E3JU-XR amplifier

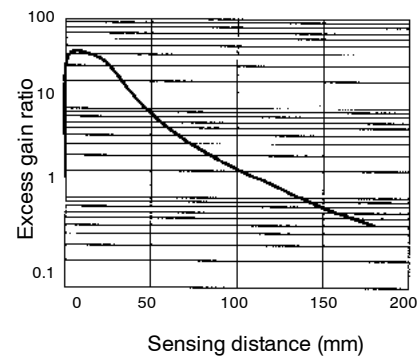

■ EXCESS GAIN RATIO (CONT.)

Diffuse, High Temperature Type

E32-D61 with E3X-A11 amplifier

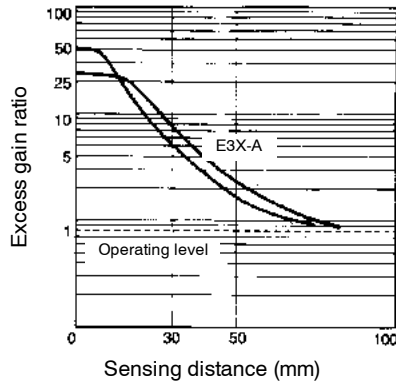

E32-D73 with E3X-A11 amplifier

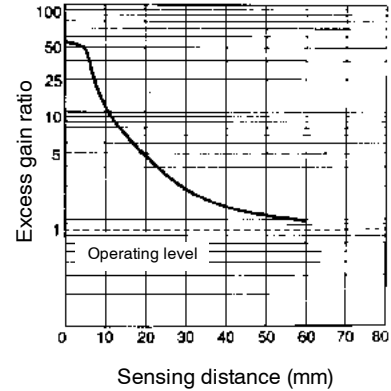

Diffuse, Special Purpose Type

E32-D12F with E3X-A, E3X-F and E3X-VG amplifiers

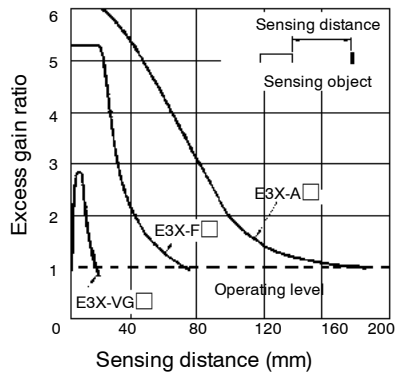

E32-L25, E32-L25A with E3X-A11 amplifier

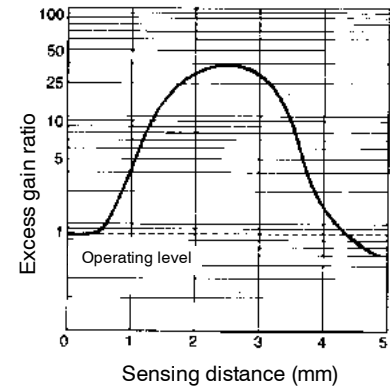

Retroreflective Type

E32-R21 with E3X-A11 amplifier

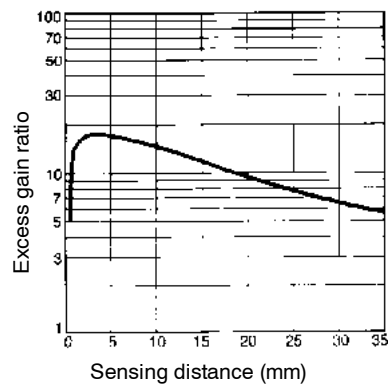

E32-R16 with E3X-A11 amplifier

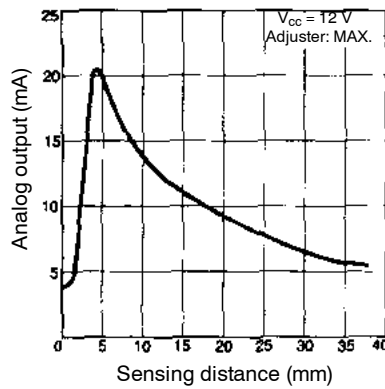

E32-R21 with E3XA-CC4A analog output amplifier

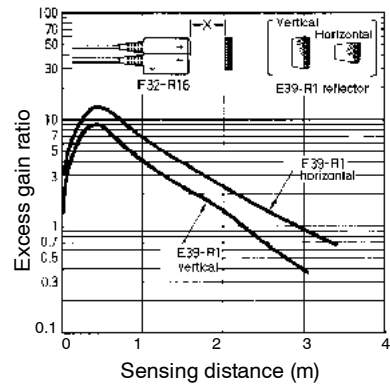

PARALLEL OPERATING RANGE (TYPICAL)

At max. sensitivity. (Use for optical axis adjustment at installation.)

E32-TC200 with E3X-DAN amplifier (Through-beam)

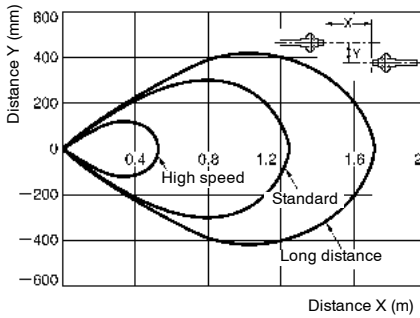

E32-T11R with E3X-DAN amplifier (Through-beam)

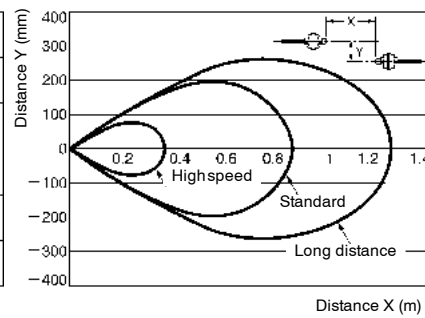

E32-T11 with E3X-DAN amplifier (Through-beam)

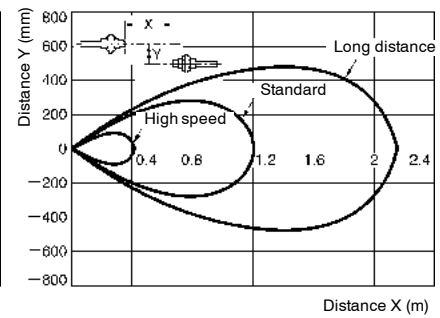

OPERATING RANGE (TYPICAL)

With standard sensing object at max. sensitivity. (Use for the positioning of the object and Sensor.)

E32-DC200 with E3X-DAN amplifier (Reflective)

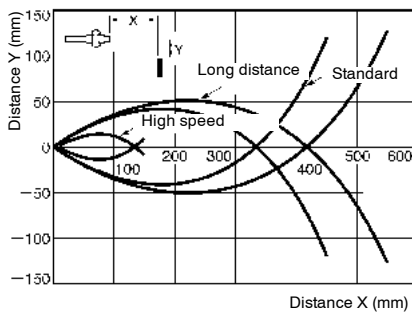

E32-D33 with E3X-DAN amplifier (Reflective)

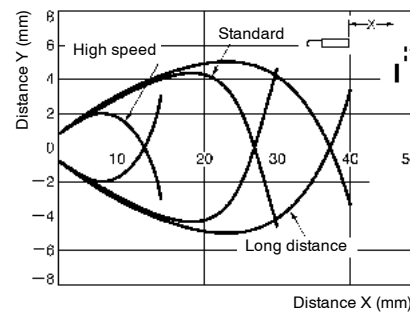

E32-L25L with E3X-DAN amplifier (Convergent Reflective)

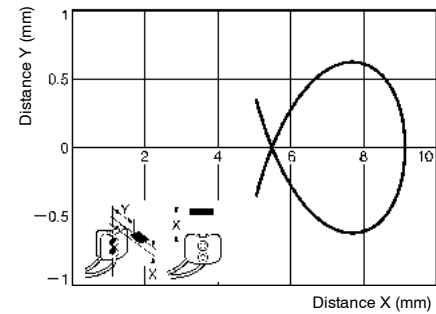

PARALLEL OPERATING RANGE (TYPICAL) MARK DETECTION SENSOR E3X-DAB11-N

At max. sensitivity. (Use for optical axis adjustment at installation.)

E32-TC200 with E3X-DAN amplifier (Through-beam)

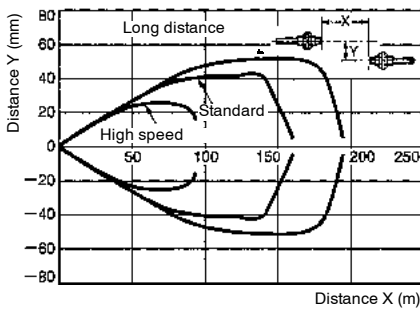

E32-TC200+E39-F1 with E3X-DAN amplifier (Through-beam)

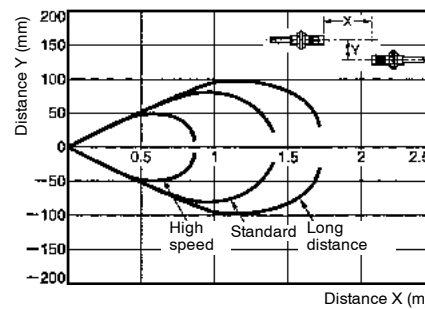

OPERATING RANGE (TYPICAL)

With standard sensing object at max. sensitivity. (Use for the positioning of the object and Sensor.)

E32-DC200 with E3X-DAN amplifier (Reflective)

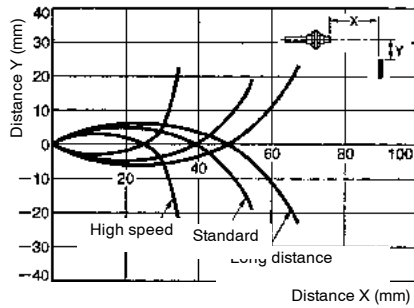

E32-CC200 with E3X-DAN amplifier (Reflective)

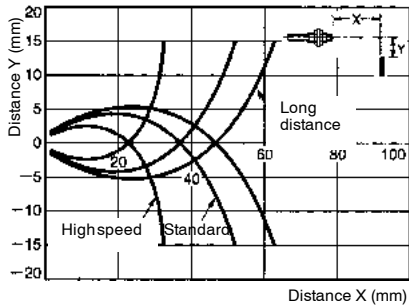

E32-D11L with E3X-DAN amplifier (Convergent Reflective)

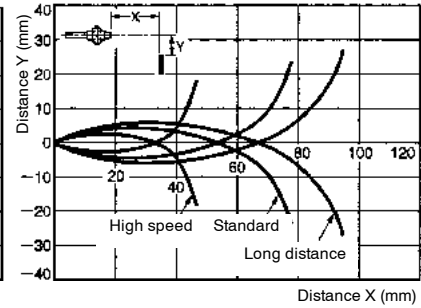

OPERATING RANGE

Through-beam, General Purpose Type

E32-T11 with E3X-DAN amplifier

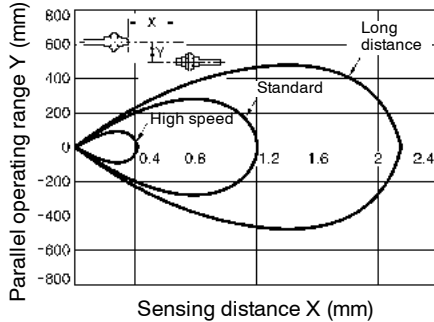

E32-TC200 (Through-beam)

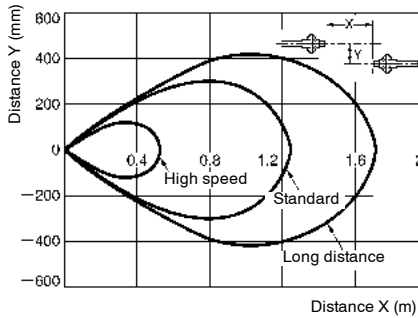

E32-T11R (Through-beam)

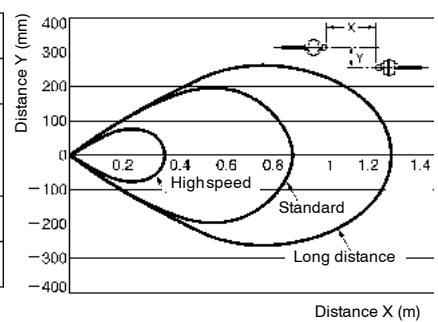

E32-T11 with E3JU-XR amplifier

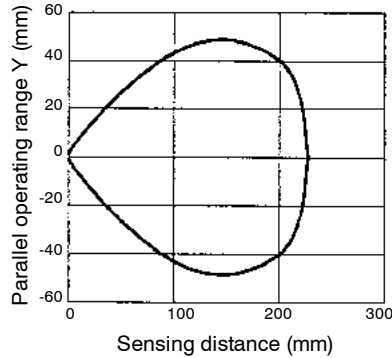

E32-T11 with E3X-NH amplifier

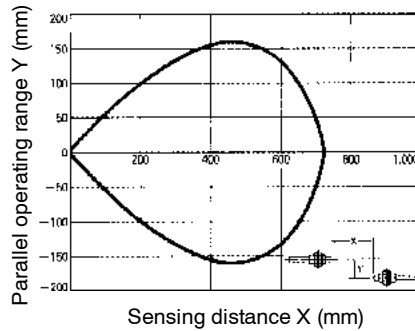

E32-T11L with E3X-A, E3X-F, and E3X-VG amplifiers

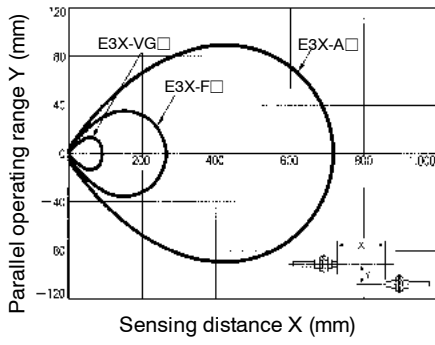

E32-T11L with E39-F1 and E3X-A, E3X-F, and E3X-VG amplifiers

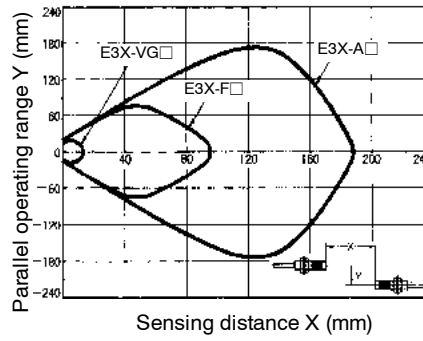

E32-T11L with E39-F2 and E3X-A, E3X-F and E3X-VG amplifiers

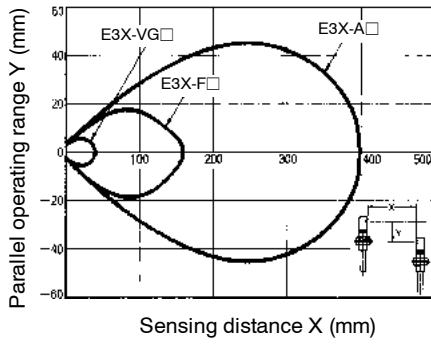

E32-T11L with E39-F3 and E3X-A and E3X-F amplifiers

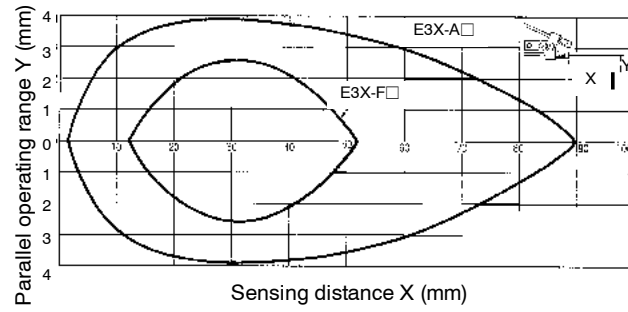

E32-T11L with E3X-H11 amplifier

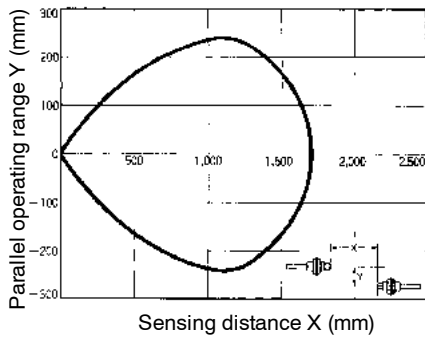

E32-T11L with E39-F1 and E3X-H11 amplifier

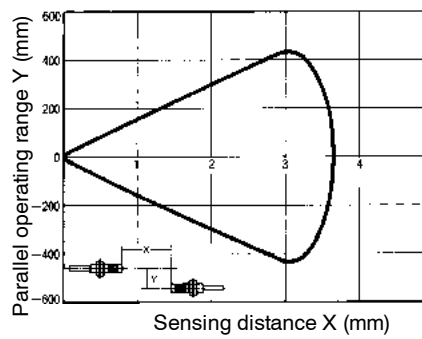

■ OPERATING RANGE (CONT.)

Through-beam, General Purpose Type

E32-T11L with E39-F2 and E3X-H11 amplifier

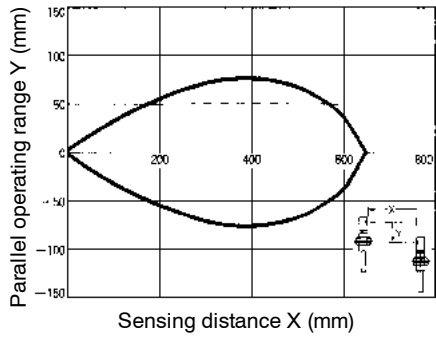

E32-T11L with E3X-NH amplifier

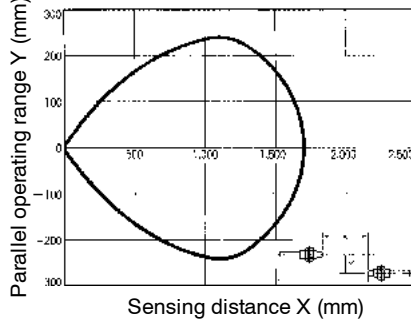

E32-T11L with E39-F1 and E3X-NH amplifier

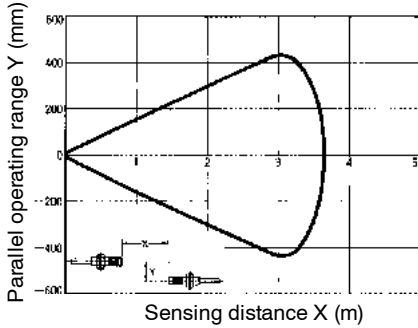

E32-T11L with E39-F2 and E3X-NH amplifier

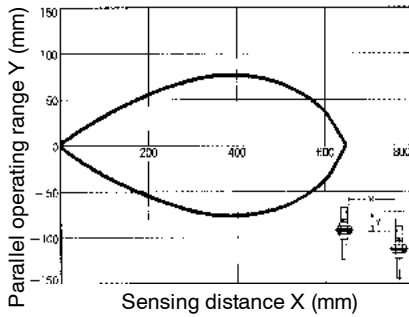

E32-T11L with E39-F3 and E3X-NH amplifier

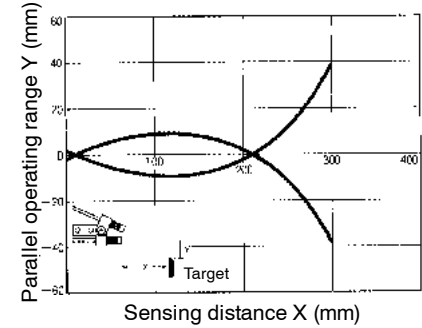

E32-T11L with E3X-NVG amplifier

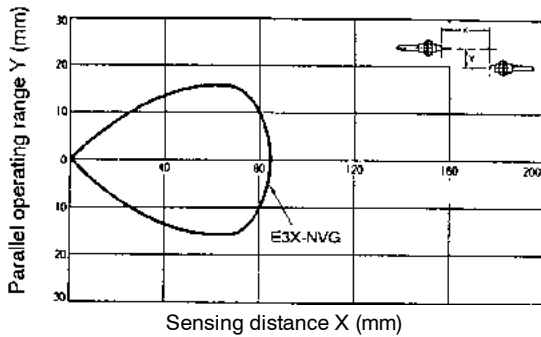

E32-T11R with E3X-NH amplifier

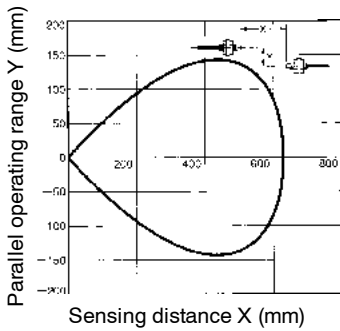

E32-T11R with E3X-DAN amplifier

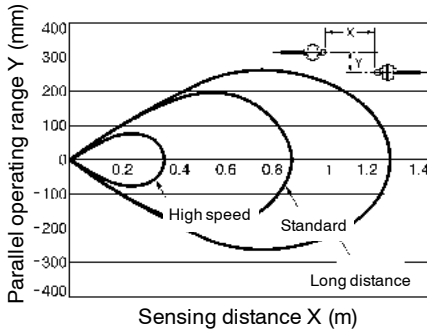

OPERATING RANGE (CONT.)

Through-beam, general purpose type

E32-T12L with E3X-A, E3X-F, and E3X-VG amplifiers

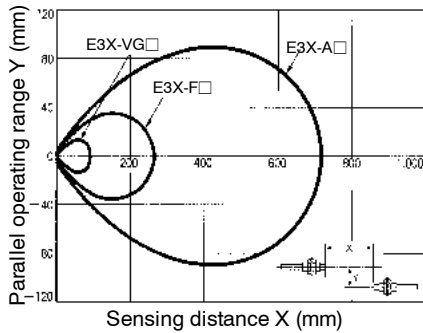

E32-T12L with E3X-NVG amplifier

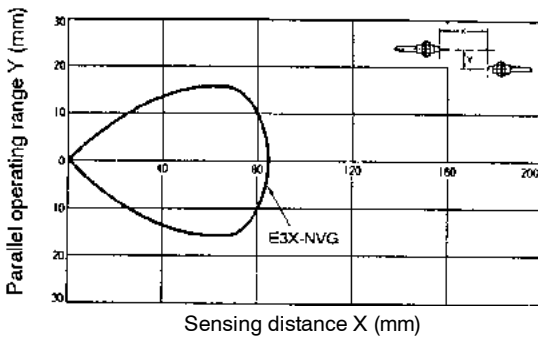

E32-T17L with E3X-A, E3X-F and E3X-VG amplifiers

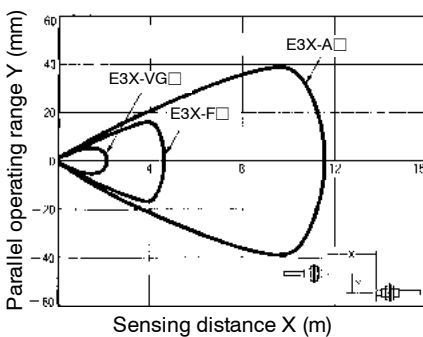

E32-T17L with E3X-H11 amplifier

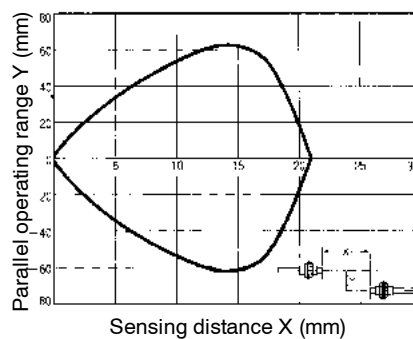

E32-T17L with E3X-NH amplifier

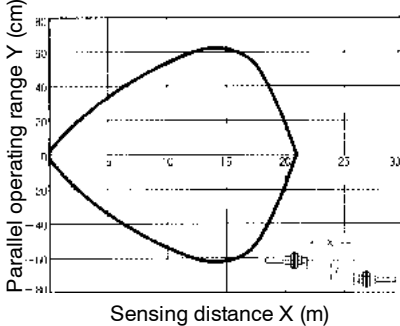

E32-T21 with E3JU-XR amplifier

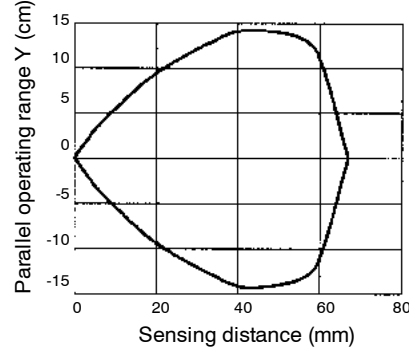

E32-T21 with E3X-NH amplifier

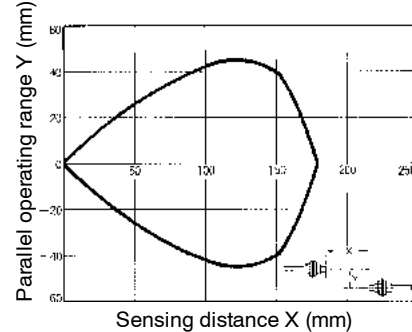

E32-T21L with E3X-A, E3X-F, and E3X-VG amplifiers

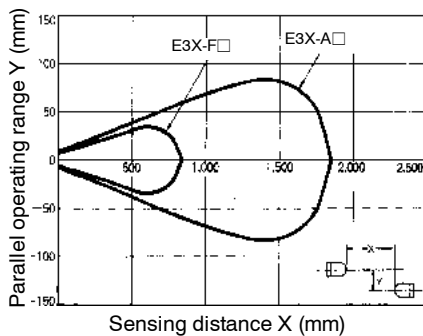

E32-T21L with E3X-H11 amplifier

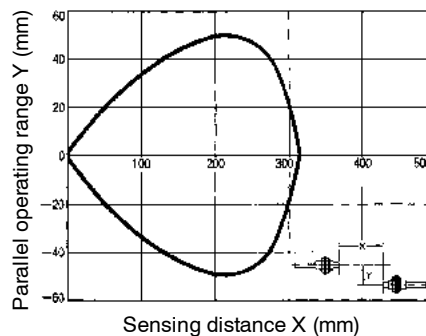

■ OPERATING RANGE (CONT.)

Through-beam, General Purpose Type

E32-T21L with E3X-NH amplifier

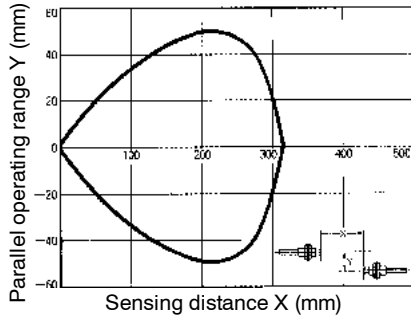

E32-T21R with E3X-NH amplifier

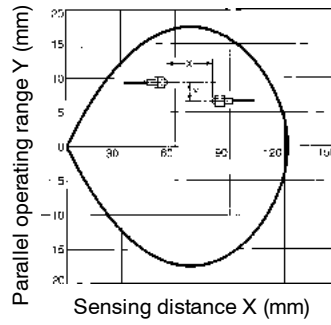

E32-T22 with E3X-A, E3X-F, and E3X-VG amplifiers

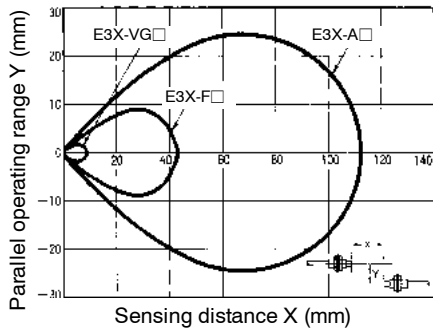

E32-T22 with E3X-NH amplifier

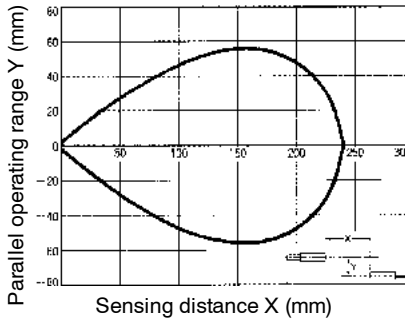

E32-T22 with E3JU-XR amplifier

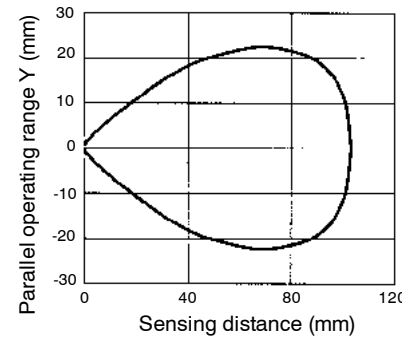

E32-T22L with E3X-A, E3X-F, and E3X-VG amplifiers

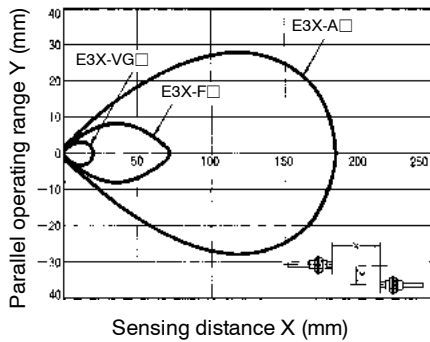

E32-TC50 with E3X-A11 amplifier

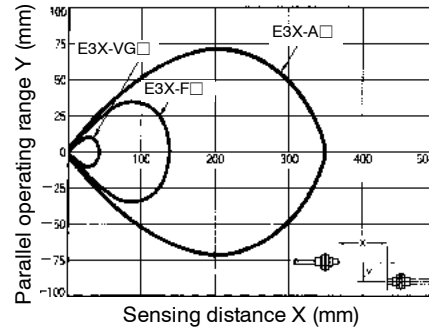

E32-TC200 with E3X-A11 amplifier

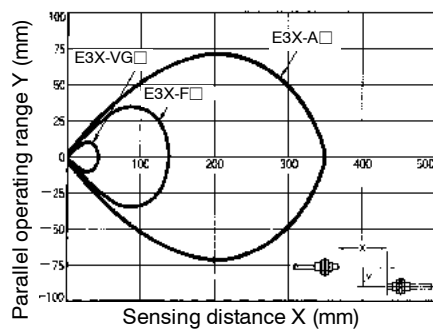

E32-TC200 with E3X-DAN amplifier

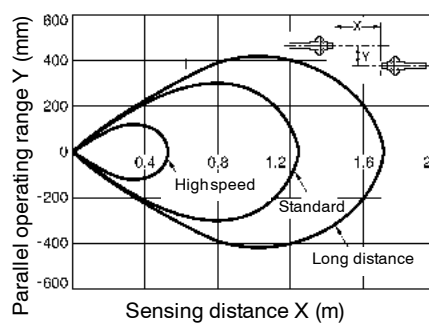

■ OPERATING RANGE (CONT.)

Through-beam, General Purpose Type

E32-TC200 with E3X-H11 amplifier

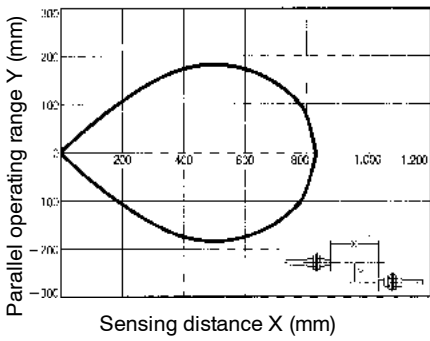

E32-TC200 with E3X-NM and E3X-NT amplifiers

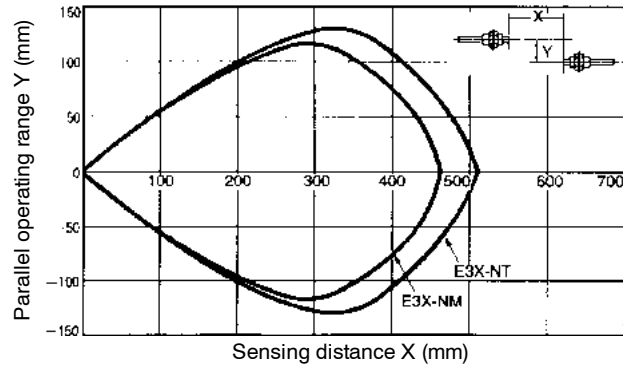

E32-TC200 with E3X-NH amplifier

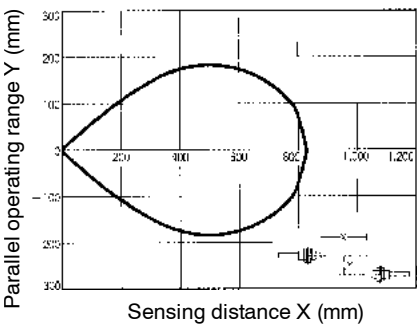

E32-TC200 with E39-F2 and E3X-NH amplifier

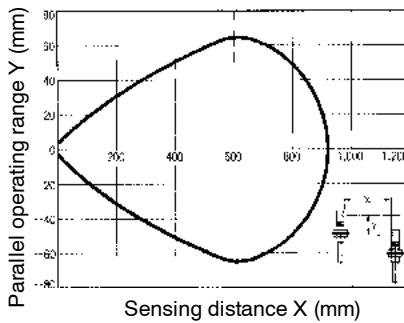

E32-TC200 with E3JU-XR amplifier

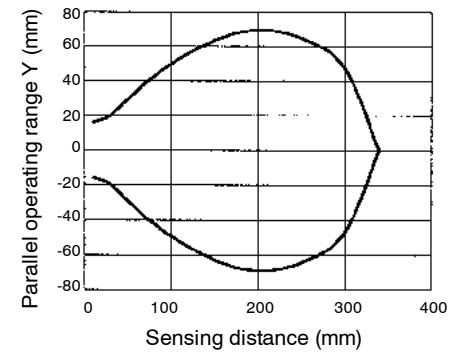

E32-TC200 with E3X-NV amplifier

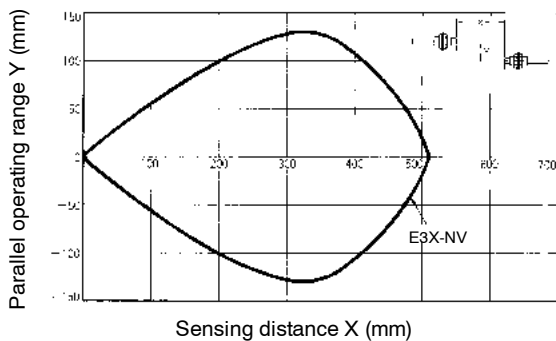

E32-TC200A with E3X-A, E3X-F, and E3X-VG amplifiers

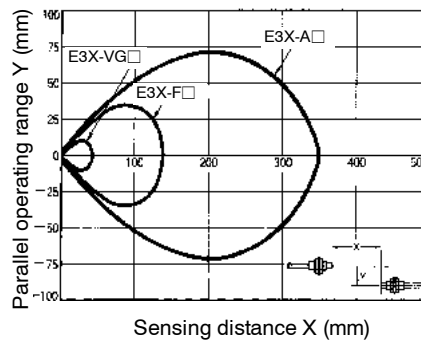

■ OPERATING RANGE (CONT.)

Through-beam, General Purpose Type

E32-TC200C with E3X-A11 amplifier

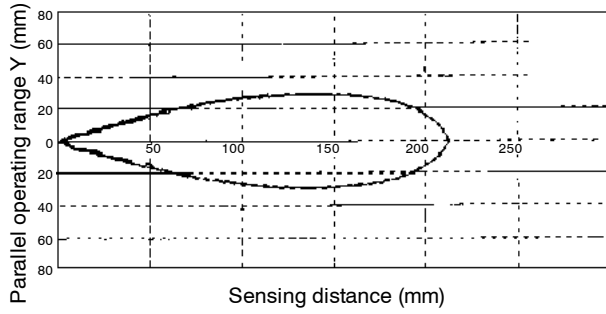

E32-TC200E with E3X-A, E3X-F and E3X-VG amplifiers

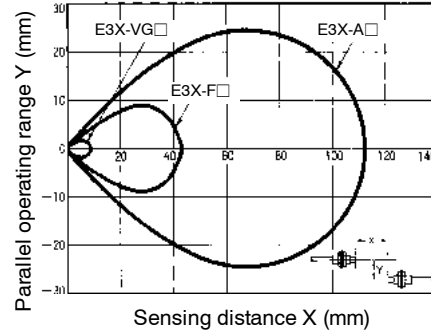

Through-beam, Armored Type

E32-UTAT1-3F with E3JU-XR amplifier

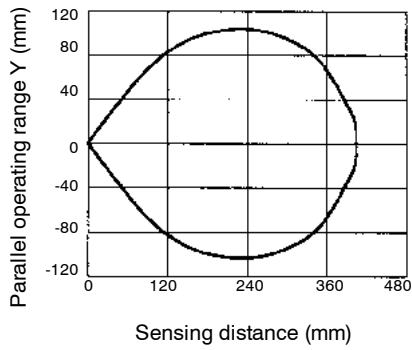

E32-UTAT1-6F with E3JU-XR amplifier

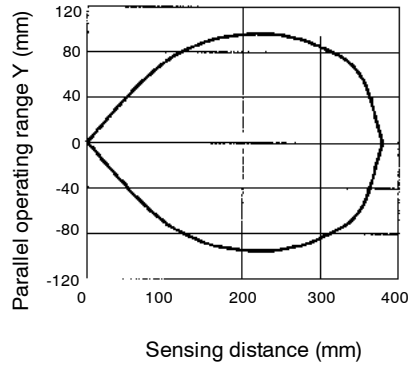

E32-UTBT1-3F with E3JU-X amplifier

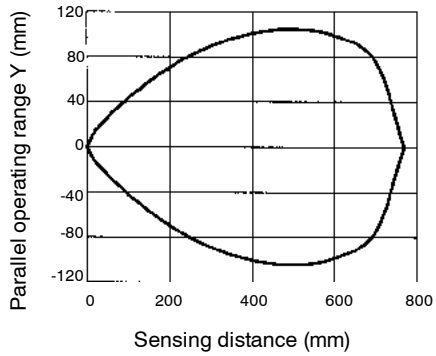

E32-UTBT1-6F with E3JU-X amplifier

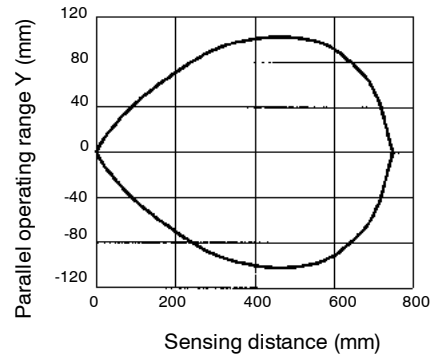

OPERATING RANGE (CONT.)

Through-beam, Probe Type

E32-TC200B and E32-TC200B4 with E3X-A11 amplifier

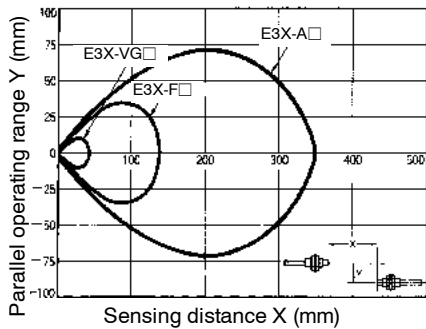

E32-TC200D and E32-TC200D4 with E3X-A11 amplifier

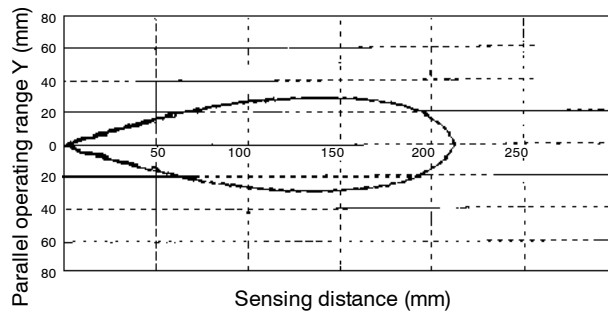

E32-TC200F and E32-TC200F4 with E3X-A11 amplifier

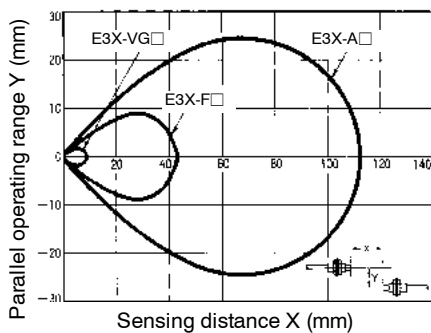

Through-beam, Side Beam Type

E32-T14 with E3X-A11 amplifier

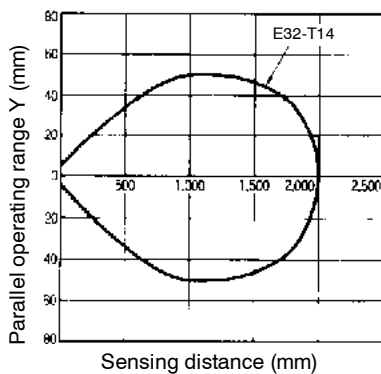

E32-T14 with E3X-NH amplifier

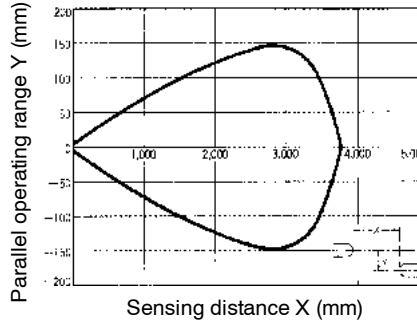

E32-T14L with E3X-A11, E3X-F, and E3X-VG amplifiers

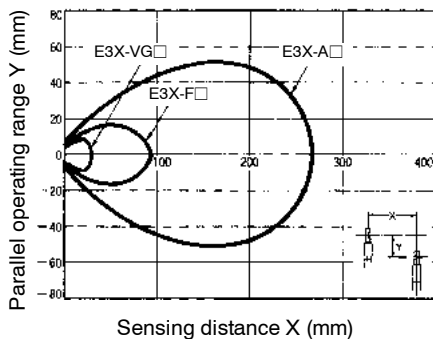

E32-T14L with E3X-H11 amplifier

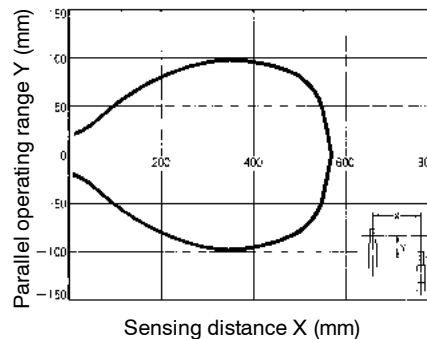

■ OPERATING RANGE (CONT.)

Through-beam, Side Beam Type

E32-T14L with E3X-NH amplifier

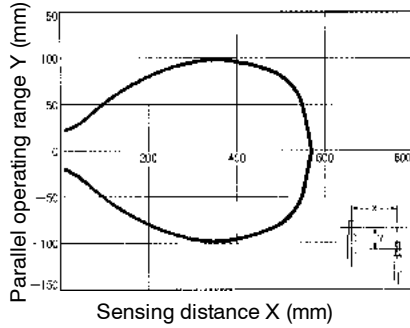

E32-T16 with E3X-A11 amplifier

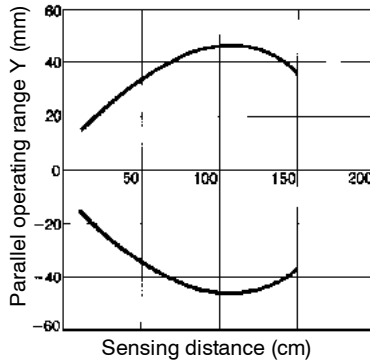

E32-T16 with E3XA-CC4A amplifier and 0.5 mm slit

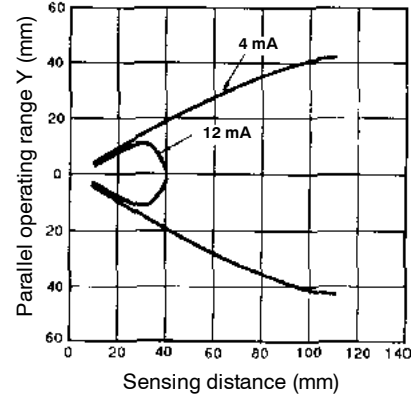

E32-T16 with E3XA-CC4A amplifier and 1 mm slit

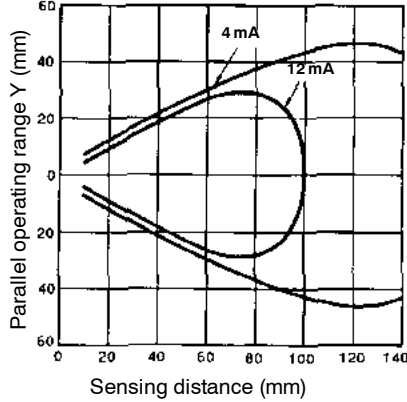

E32-T24 with E3X-A11 amplifier

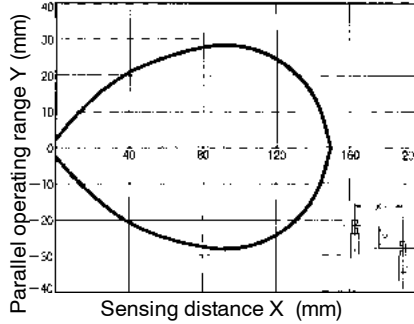

E32-T24 with E3X-NH amplifier

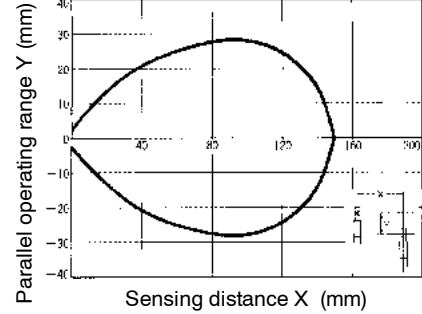

Through-beam, High Temperature Type

E32-T51 with E3X-A and E3X-F amplifiers

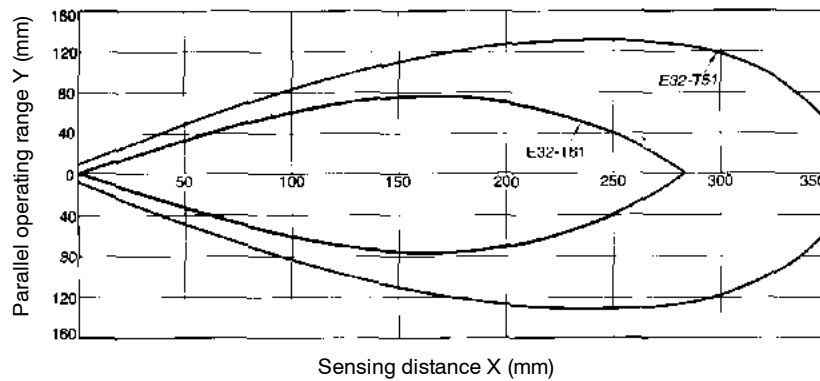

E32-T51 with E3X-NH amplifier

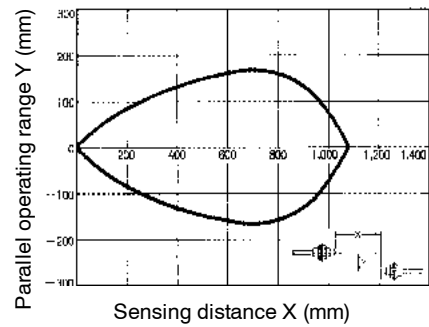

■ OPERATING RANGE (CONT.)

Through-beam, High Temperature Type

E32-T51 with E3JU-XR amplifier

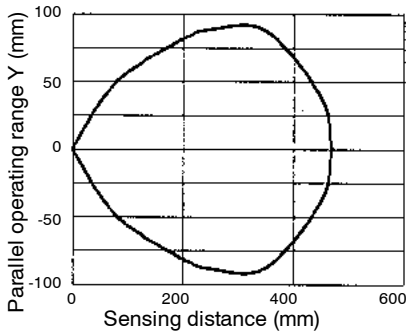

E32-T61 with E3X-H11 amplifier

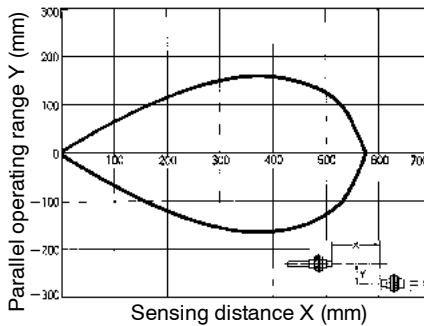

E32-T61 with E3X-NH amplifier

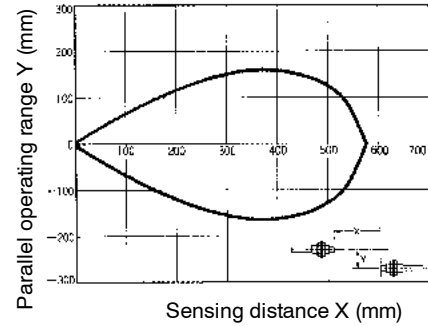

Through-beam, Special Purpose Type

E32-M21 with E3X-A11 amplifier

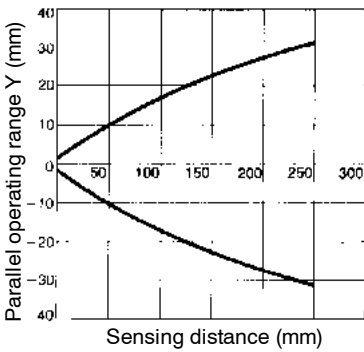

E32-M21 with E3X-NH amplifier

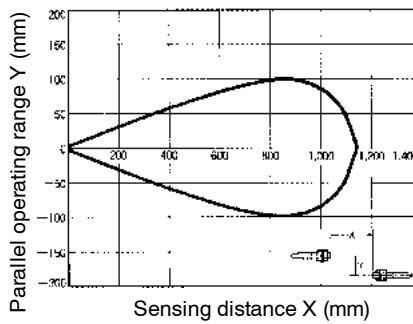

E32-T12F with E3X-NH amplifier

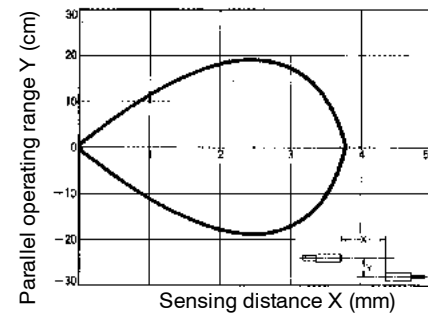

E32-T12F with E3X-A, E3X-F, and E3X-VG amplifiers

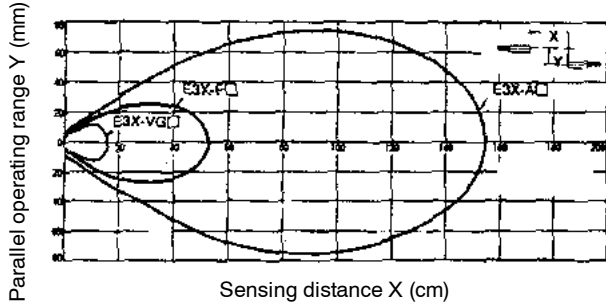

E32-T12F with E3X-H11 amplifier

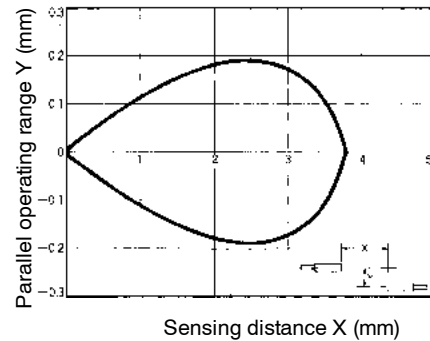

E32-T22S with E3X-NH amplifier

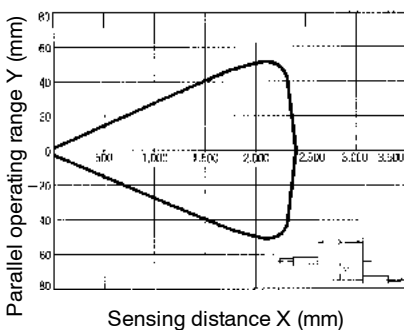

E32-T24S with E3X-NH amplifier

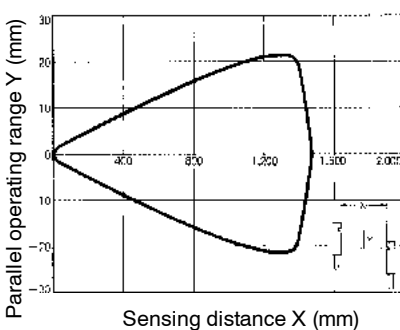

E32-T84S with E3X-NH amplifier

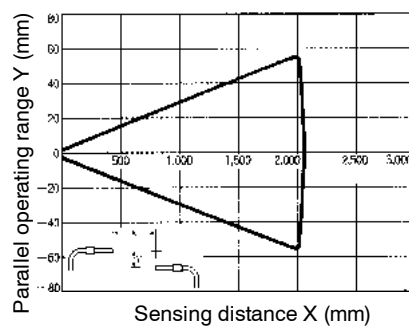

■ OPERATING RANGE (CONT.)

Diffuse, General Purpose Type

E32-CC200 with E3X-A and E3X-F amplifiers

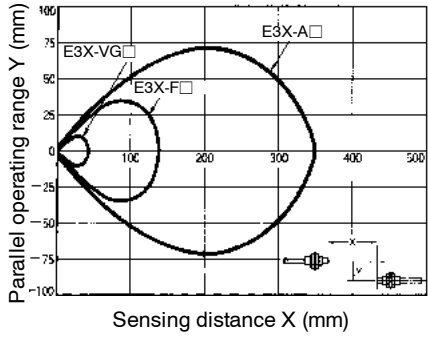

E32-CC200 with E3X-NH amplifier

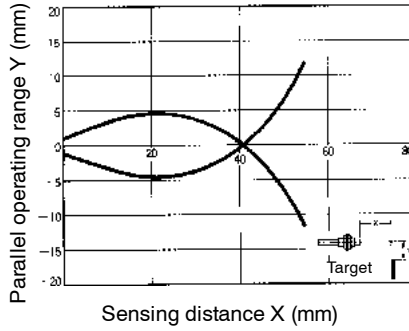

E32-CC200 with E3MC-Y amplifier

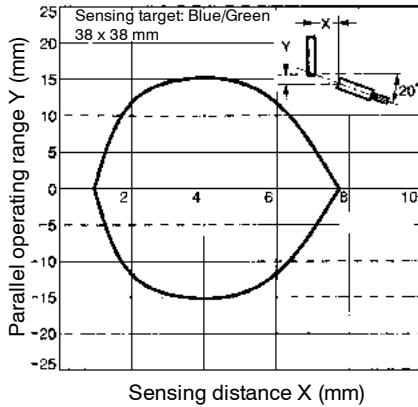

E32-D11 with E3X-NH amplifier

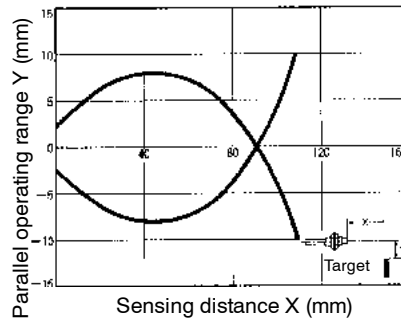

E32-D11 with E3JU-XR amplifier

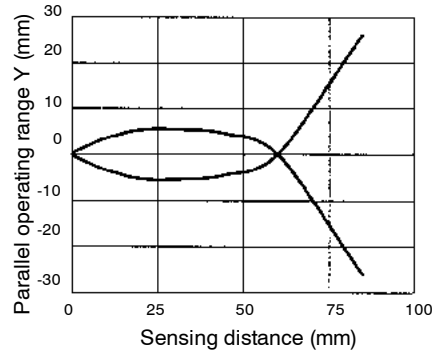

E32-D11L with E3X-A, E3X-F, and E3X-VG amplifiers

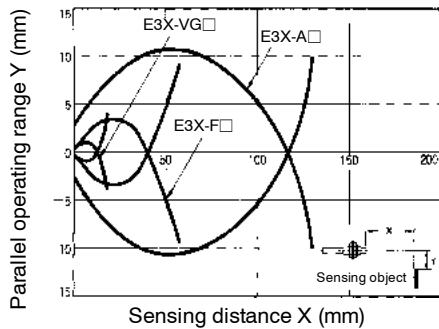

E32-D11L with E3X-H11 amplifier

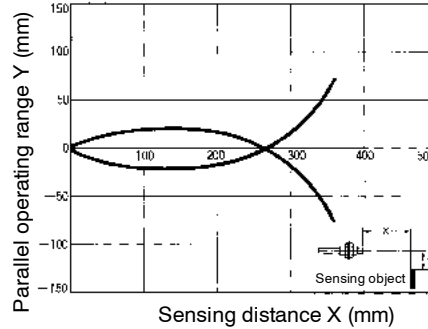

E32-D11L with E3X-NH amplifier

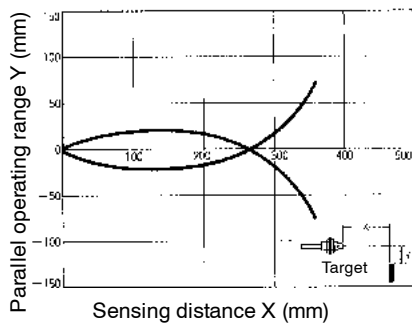

E32-D11L with E3X-NVG amplifier

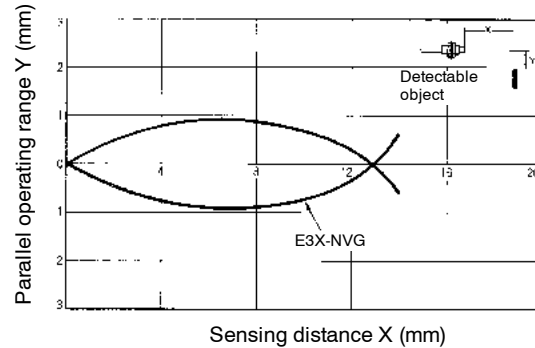

■ OPERATING RANGE (CONT.)

Diffuse, General Purpose Type

E32-D11L with E3MC-Y amplifier

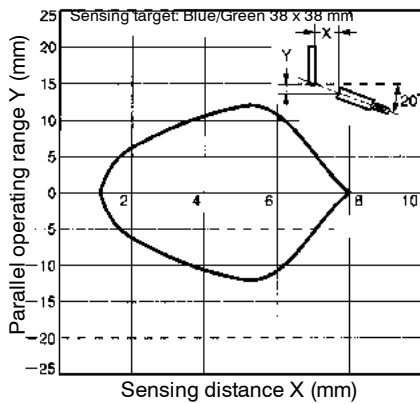

E32-D11R with E3X-NH amplifier

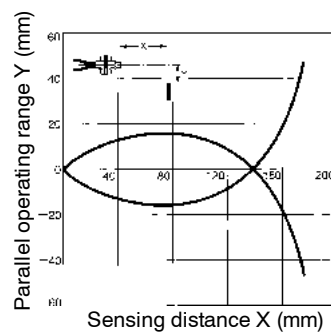

E32-D21 with E3X-A, E3X-F and E3X-VG amplifiers

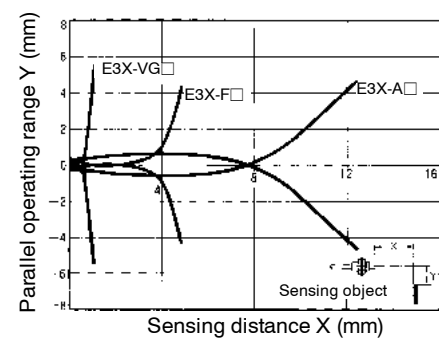

E32-D21 with E3X-NH amplifier

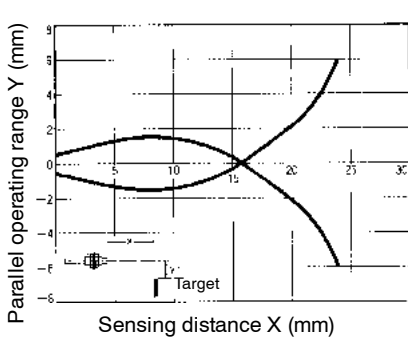

E32-D21 with E3JU-XR amplifier

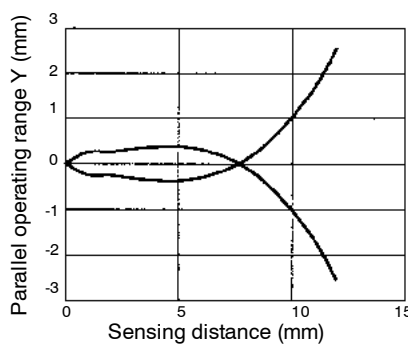

E32-D21L with E3X-A and E3X-F amplifiers

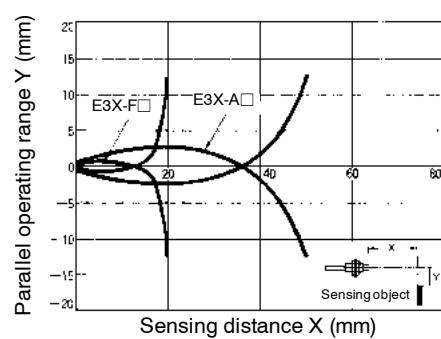

E32-D21L with E3X-H11 amplifier

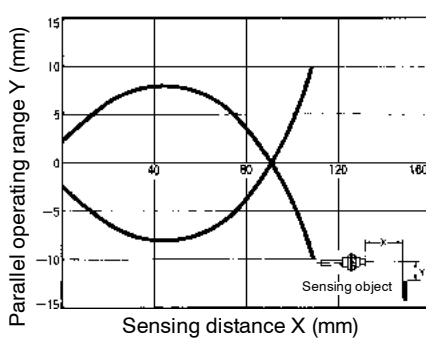

E32-D21L with E3X-NH amplifier

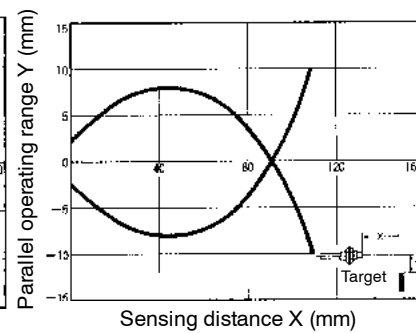

E32-D21R with E3X-DAN amplifier

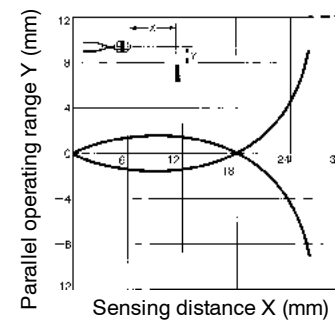

E32-D22L with E3X-A and E3X-F amplifiers

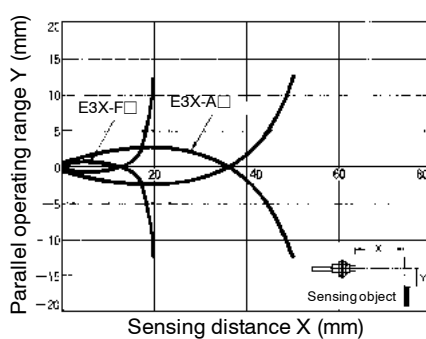

E32-D32 with E3X-A11 amplifier

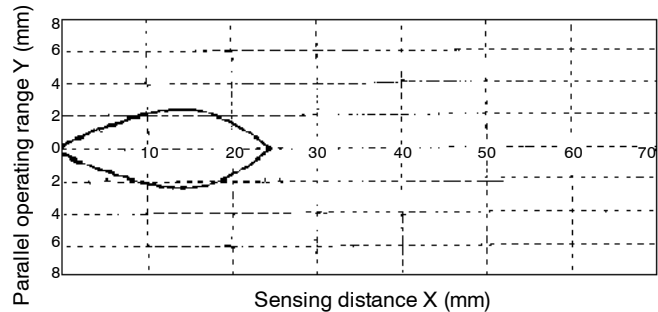

■ OPERATING RANGE (CONT.)

Diffuse, General Purpose Type

E32-D32 with E3X-NH amplifier

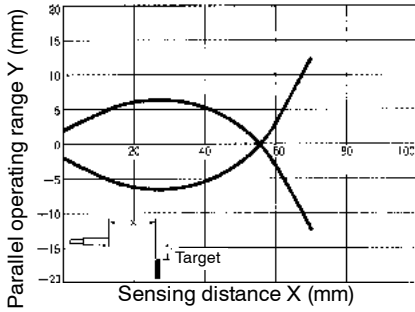

E32-D32 with E3JU-XR amplifier

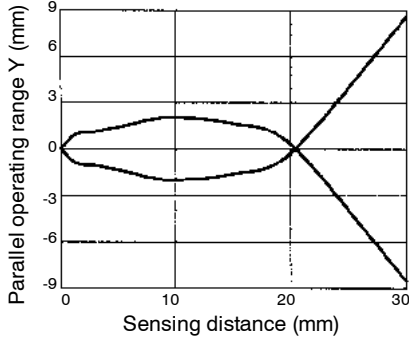

E32-D32L with E3X-A, E3X-F, and E3X-VG amplifiers

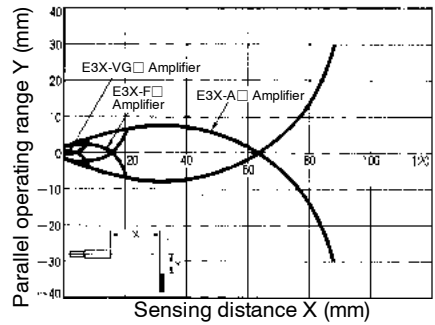

E32-D32L with E3X-NH amplifier

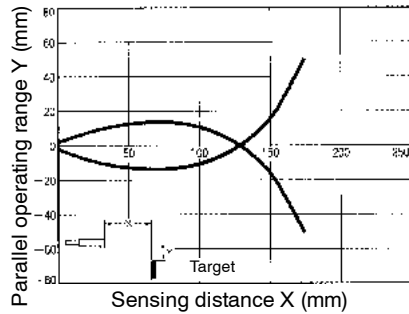

E32-D32L with E3MC-Y amplifier

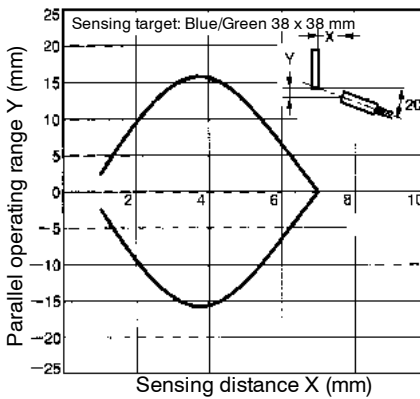

E32-DC50 with E3X-A, E3X-F, and E3X-VG amplifiers

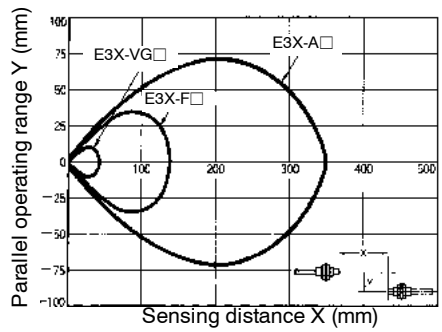

E32-DC200 with E3X-A, E3X-F, and E3X-VG amplifier

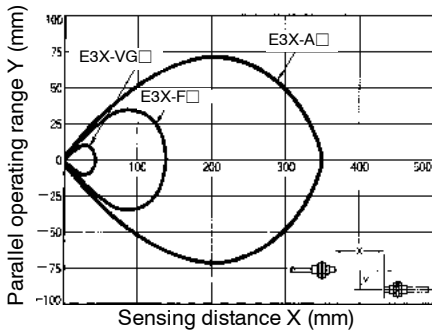

E32-DC200 with E3X-H11 amplifier

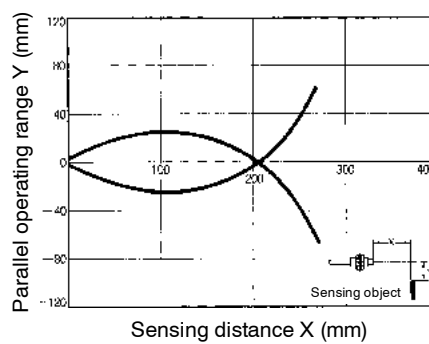

E32-DC200 with E3X-DAN amplifier

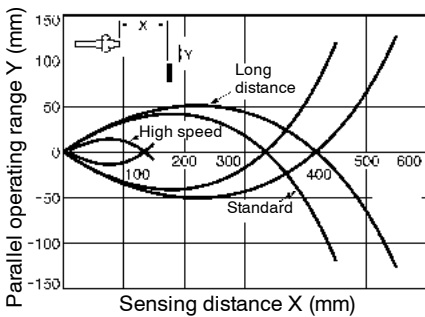

E32-DC200 with E3X-NH amplifier

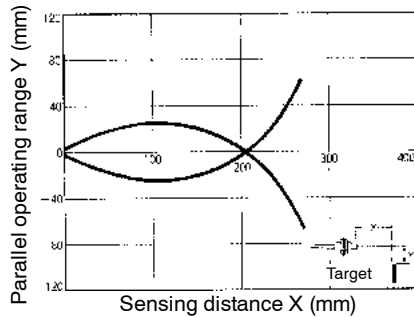

E32-DC200 with E3JU-XR amplifier

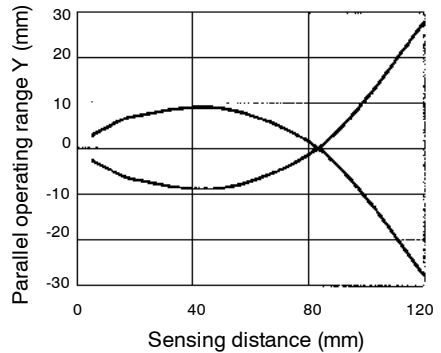

OPERATING RANGE (CONT.)

Diffuse, General Purpose Type

E32-DC200 with E3X-NM and E3X-NT amplifiers

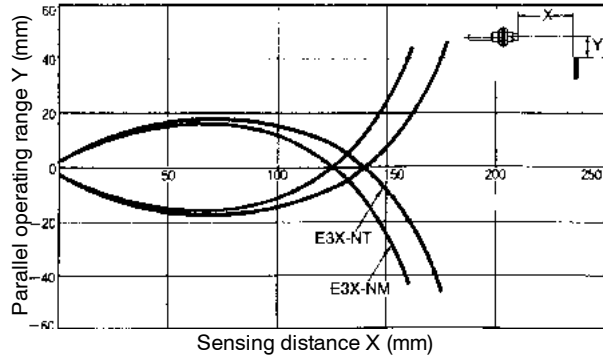

E32-DC200 with E3X-NV amplifier

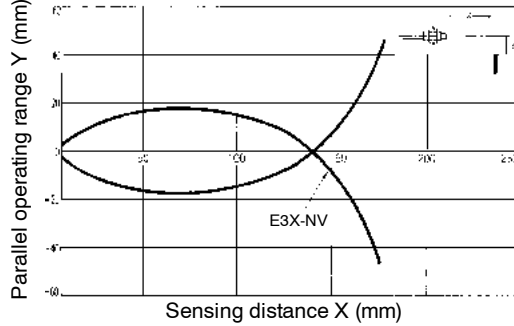

E32-DC200 with E3MC-Y amplifier

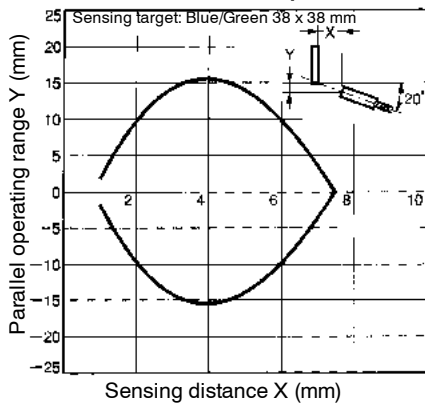

E32-DC200C with E3X-A11 amplifier

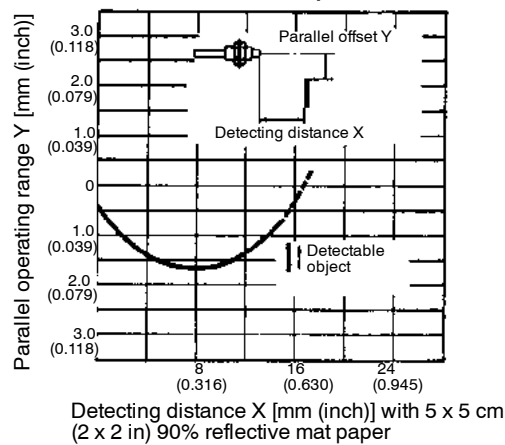

E32-DC200E with E3X-A11 amplifier

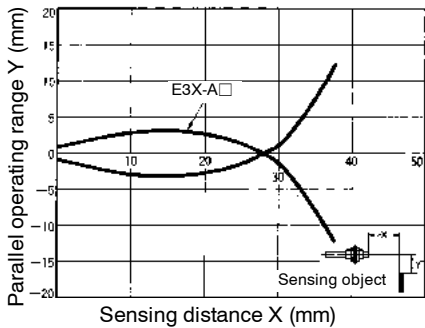

Diffuse, Armored Type

E32-UDAT1-3F with E3JU-XR amplifier

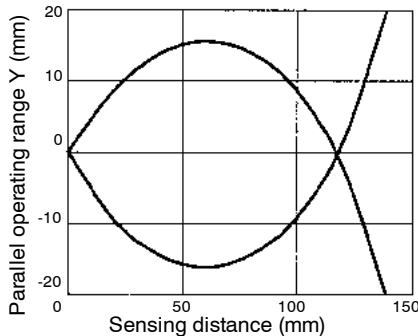

E32-UDAT1-6F with E3JU-XR amplifier

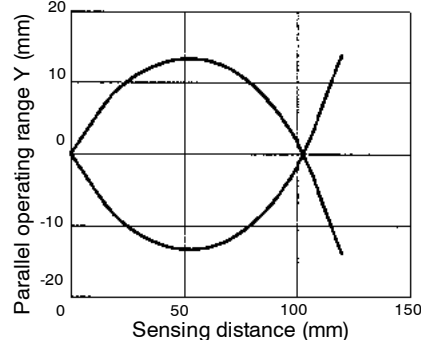

■ OPERATING RANGE (CONT.)

Diffuse, Armored Type

E32-UDAT1-3F and E32-UDAT1-6F with E3X-A11 amplifier

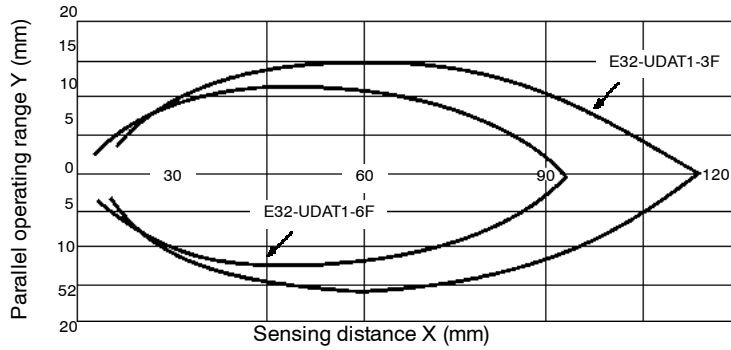

E32-UDBT1-3F with E3JU-X amplifier

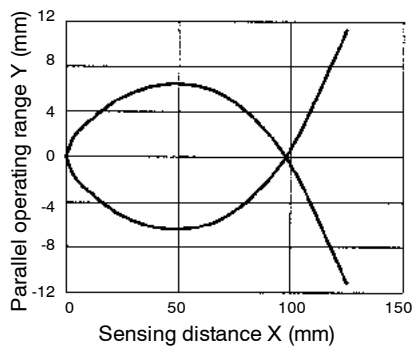

E32-UDBT1-6F with E3JU-X amplifier

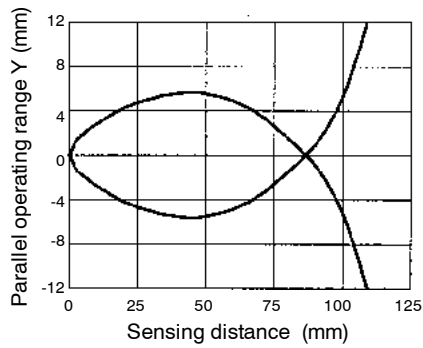

Diffuse, Probe Type

E32-D33 with E3X-A11 amplifier

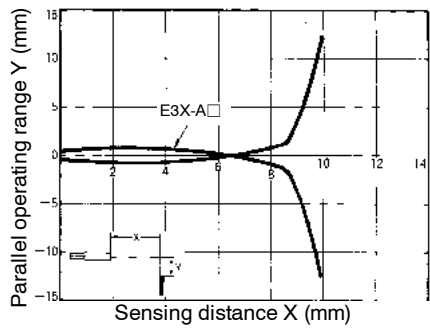

E32-D33 with E3X-DAN amplifier

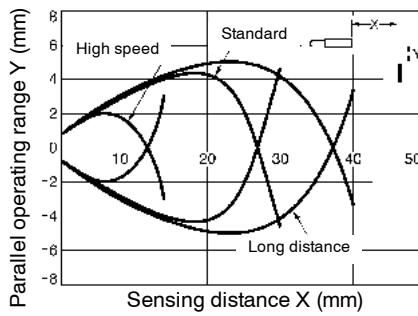

E32-D33 with E3X-NH amplifier

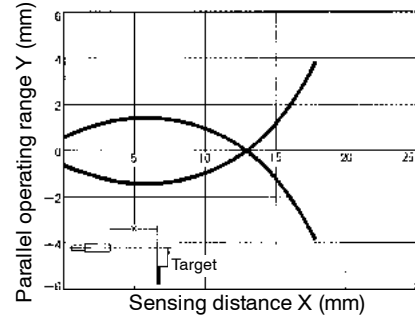

E32-DC200B and E32-DC200B4 with E3X-A and E3X-F amplifiers

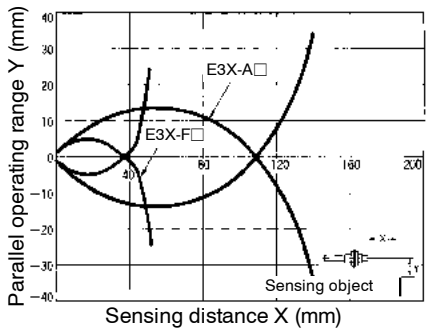

E32-DC200F with E3X-NH amplifier

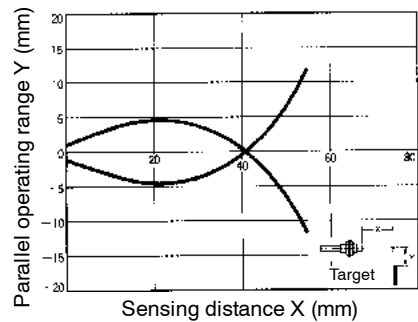

E32-DC200F and E32-DC200F4 with E3X-A11 amplifier

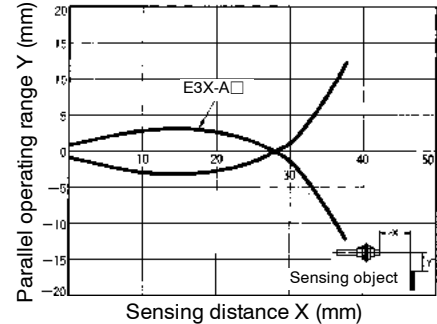

OPERATING RANGE (CONT.)

Diffuse, Side Beam Type

E32-D14L with E3X-A, E3X-F and E3X-VG amplifiers

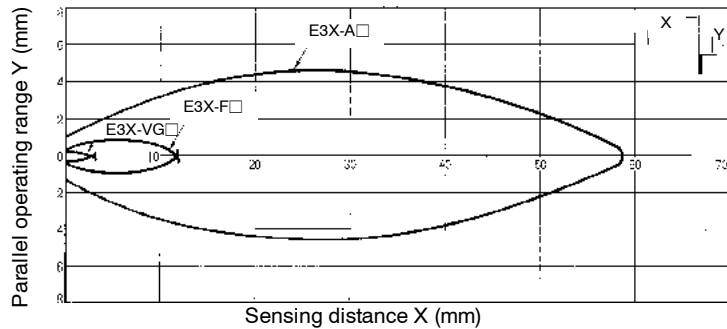

E32-D24 with E3X-A and E3X-F amplifiers

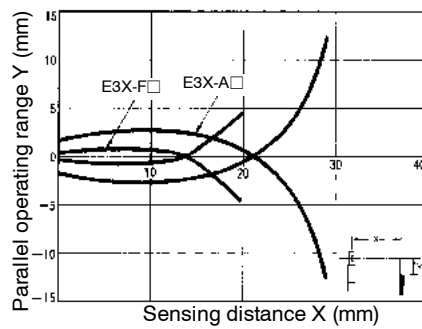

Diffuse, High Temperature Type

E32-D51 with E3X-A and E3X-F amplifiers

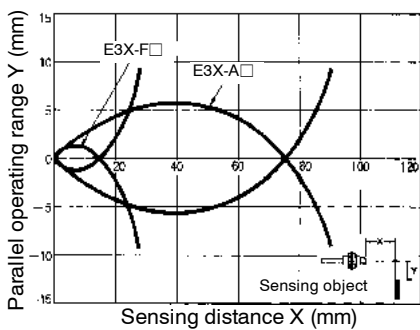

E32-D51 with E3X-NH amplifier

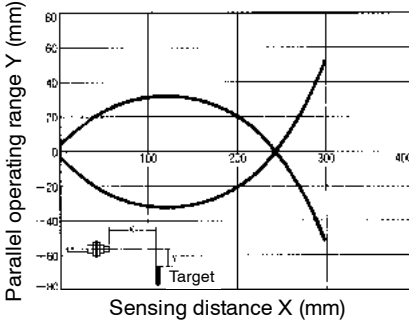

E32-D51 with E3JU-XR amplifier

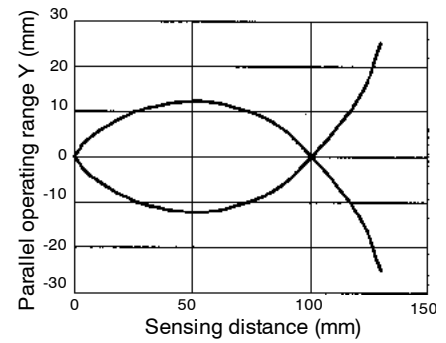

E32-D61 with E3X-A and E3X-F amplifiers

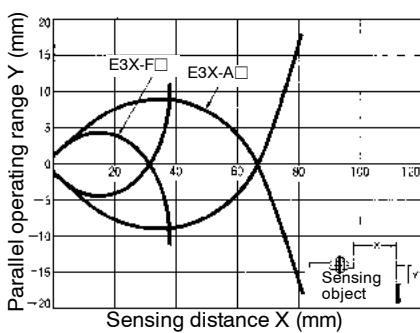

E32-D73 with E3X-A and E3X-F amplifiers

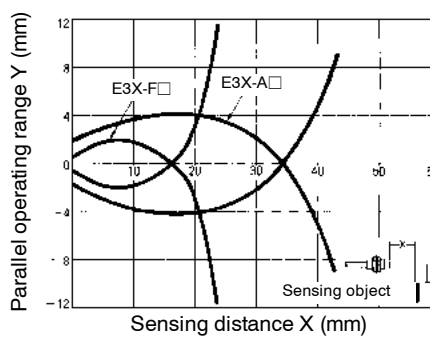

■ OPERATING RANGE (CONT.)

Diffuse, Convergent and Special Purpose Types

E32-D12F with E3X-A, E3X-F and E3X-VG amplifiers

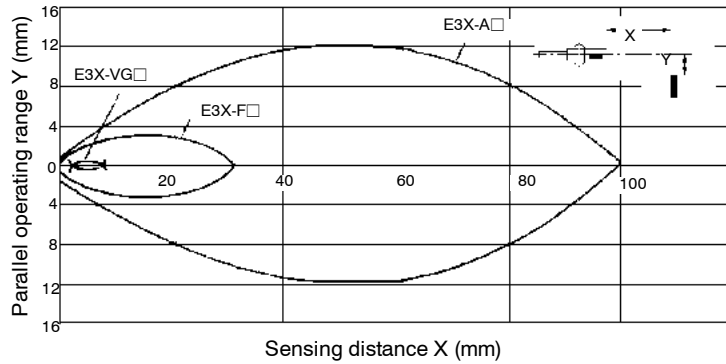

E32-L25 and E32-L25A with E3X-A11 amplifier

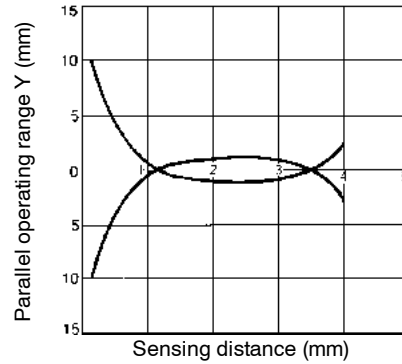

E32-L25L with E3X-A amplifier

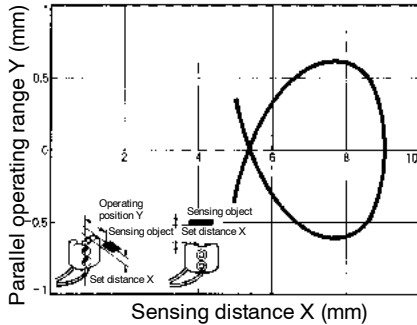

E32-L25L with E3X-DAN amplifier

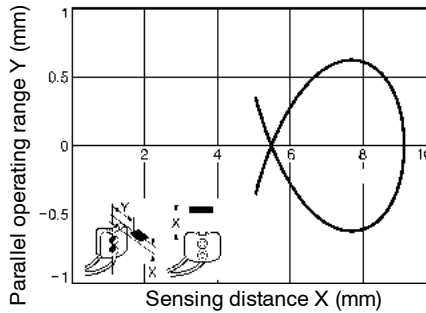

E32-L25L with E3X-NH amplifier

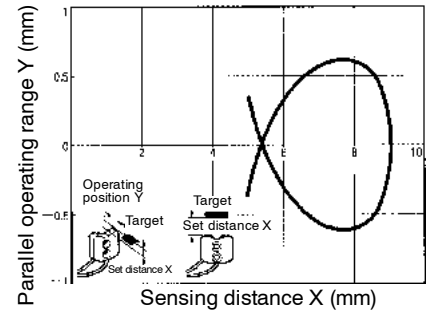

Retroreflective Type

E32-R21 with E3X-A11 amplifiers

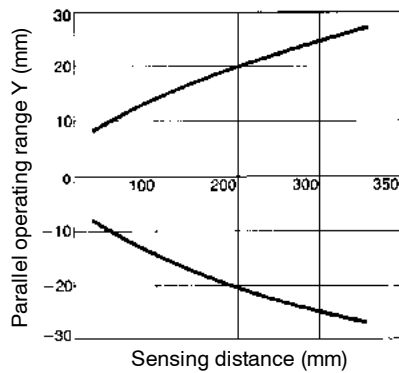

E32-R21 with E3XA-CC4A amplifier and E39-R3 reflector

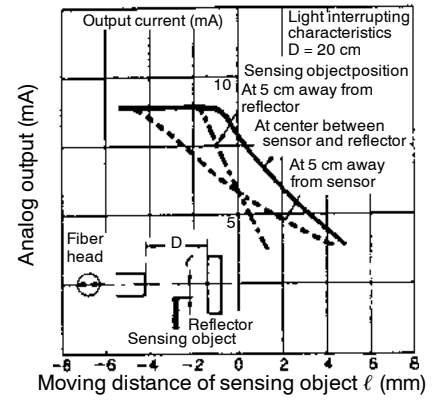
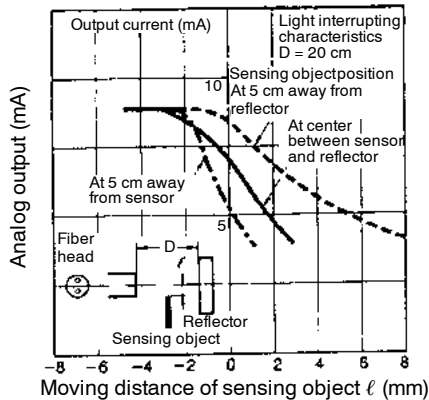

ANALOG OUTPUT VS. DISTANCE (STANDARD MODE)

E32-TC200 with E3X-DAN amplifier (Through-beam)

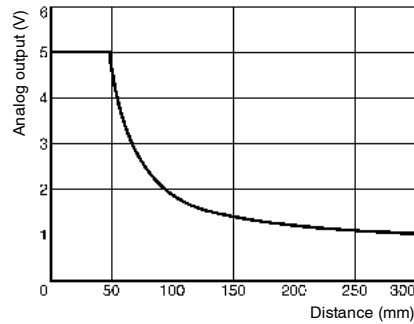

E32-DC200 with E3X-DAN amplifier (Diffuse)

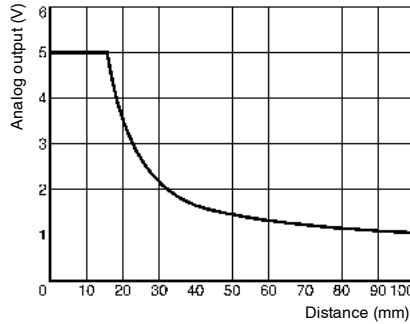

ADDITIONAL DATA

With standard sensing object. With standard target at maximum sensitivity.

**Sensing Distance vs. Operating Range
E32-DC200 with E3X-DAN amplifier (Reflective)**

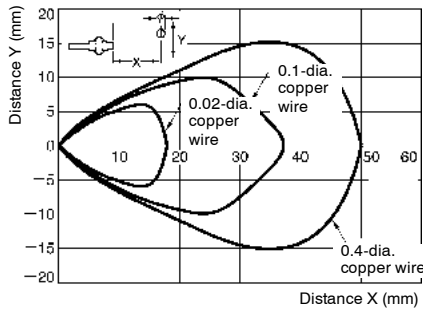

**Differential Travel vs. Sensing Distance
E32-D11L with E3X-DAN amplifier (Reflective)**

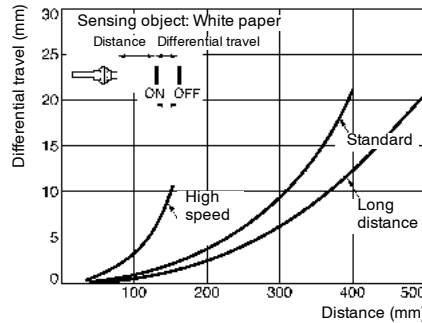

**Repeat Accuracy vs. Sensing Distance
E32-DC200 with E3X-DAN amplifier (Reflective)**

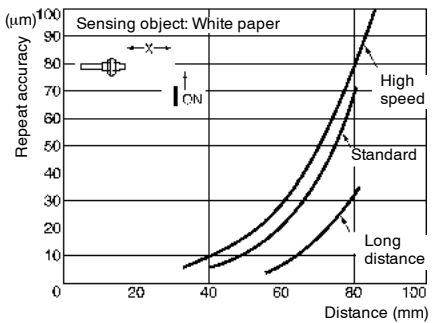

Dimensions

Unit: mm (inch)

■ THROUGH-BEAM TYPE

(Sold in pairs)

General Purpose

E32-T11

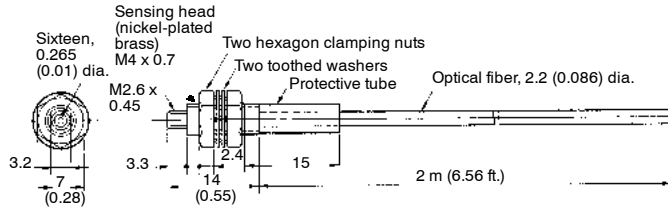

E32-T11L

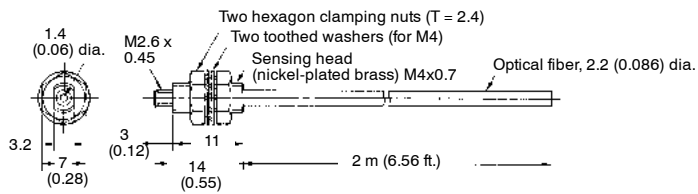

E32-T11R

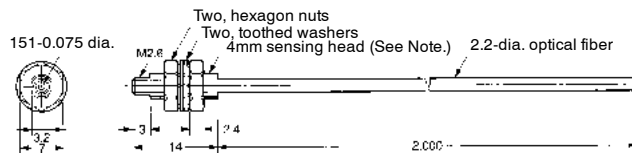

Note: The sensing head is made of nickel-plated brass.

E32-T12L

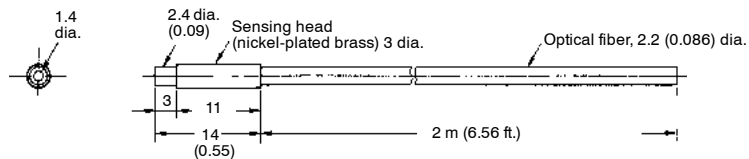

E32-T17L

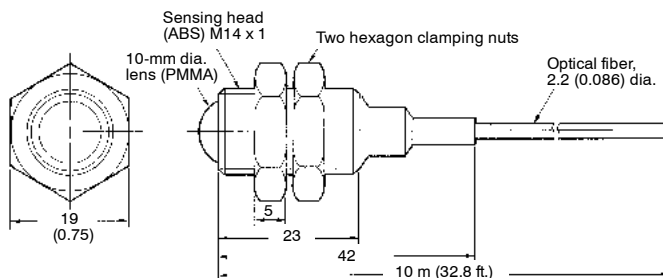

■ THROUGH-BEAM TYPE (CONT.)

E32-T21

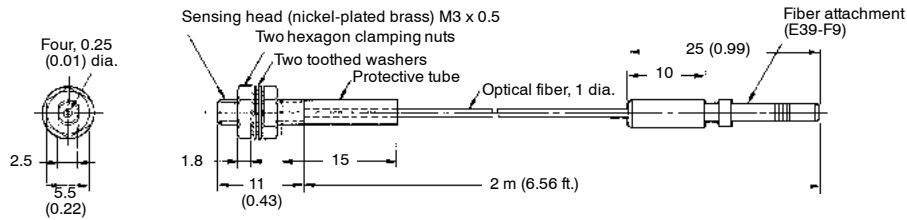

E32-T21L

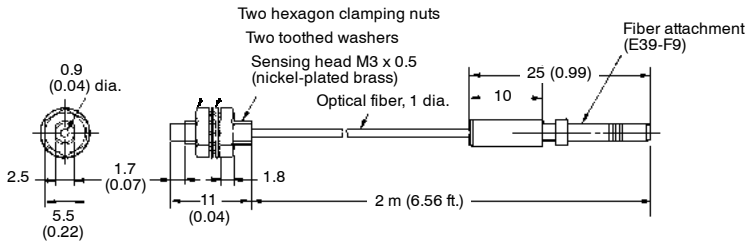

E32-T21R

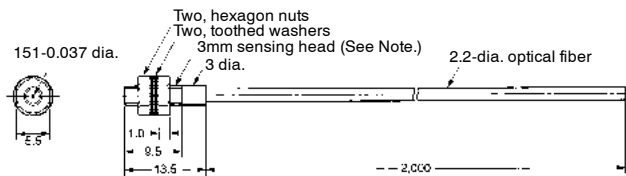

Note: The sensing head is made of nickel-plated brass.

E32-T22

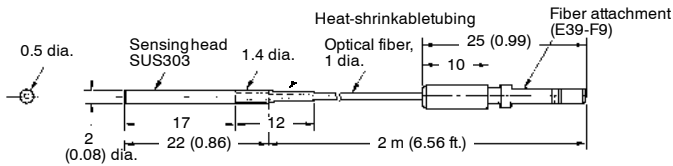

E32-T22L

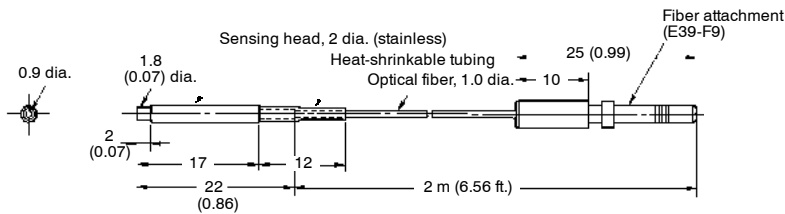

■ THROUGH-BEAM TYPE (CONT.)

E32-TC50, E32-TC200, E32-TC500,
E32-TC1000

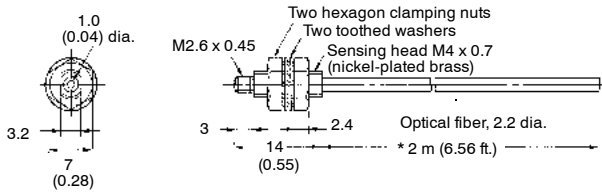

* This length is 50 cm for E32-TC50, 5 m for E32-TC500 and 10 m for E32-TC10000.

E32-TC200A

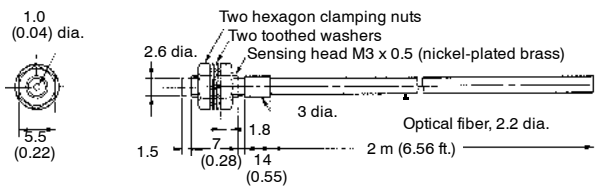

E32-TC200C

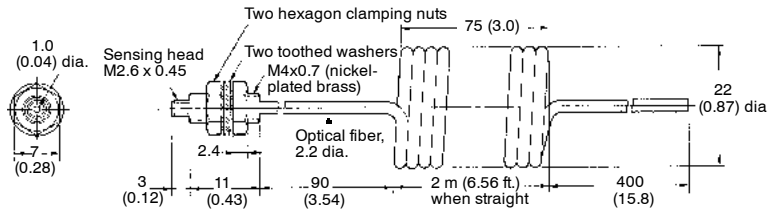

E32-TC200E

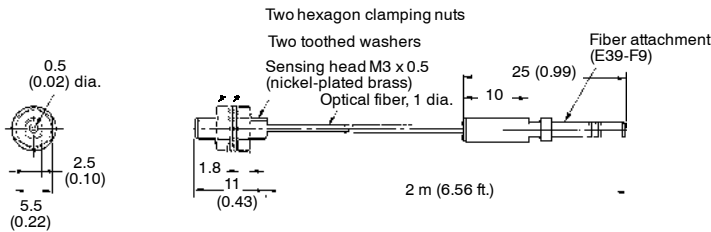

Armored Type

E32-UTAT1-3F
E32-UTAT1-6F

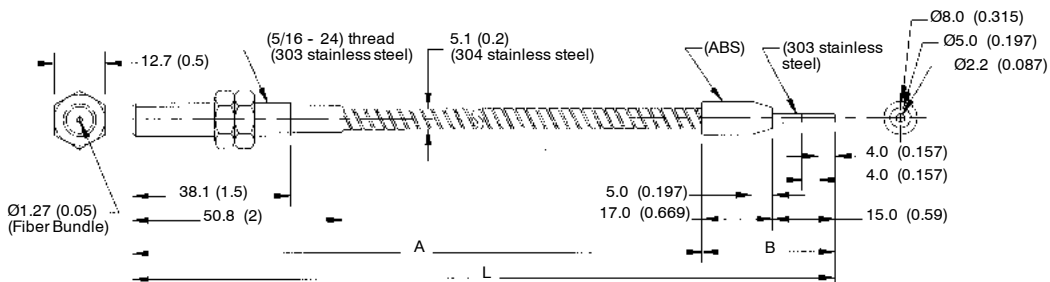

Note: 1. Distance A can withstand 150°C (302°F); Distance B can withstand 70°C (158°F);
2. L = 3ft. for E32-UTAT1-3F; 6ft. for E32-UTAT1-6F

THROUGH-BEAM TYPE (CONT.)

E32-UTBT1-3F
E32-UTBT1-6F

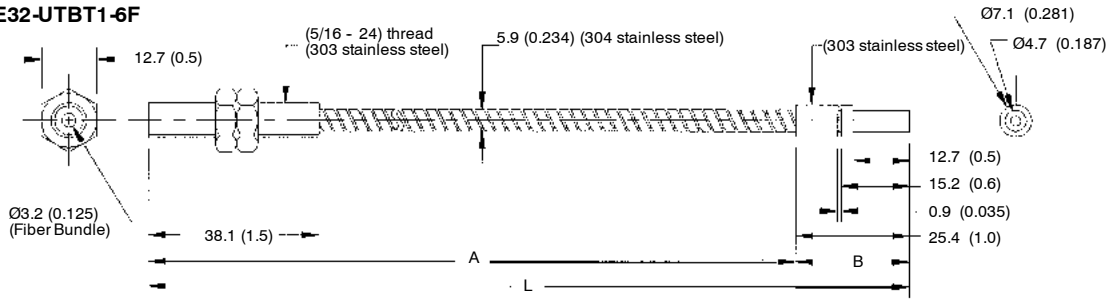

Note: 1. Distance A can withstand 200°C (392°F); Distance B can withstand 70°C (158°F);
2. L = 3ft. for E32-UTAT1-3F; 6ft. for E32-UTAT1-6F

Probe Type

E32-T33-1

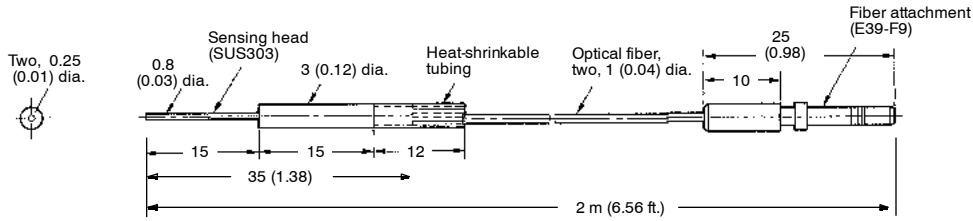

E32-TC200B
E32-TC200B4

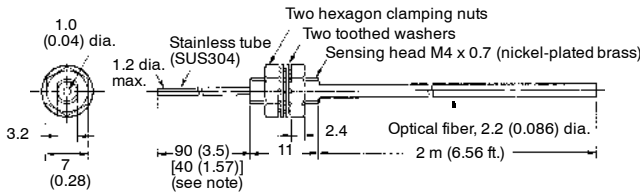

Note: The values in the brackets are for the E32-TC200B4.

E32-TC200D
E32-TC200D4

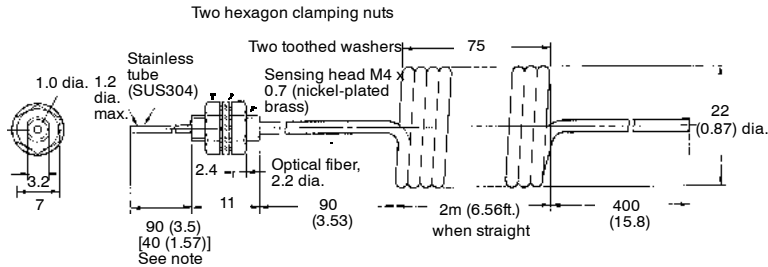

Note: The values in the brackets are for the E32-TC200D4.

■ THROUGH-BEAM TYPE (CONT.)

E32-TC200F
E32-TC200F4

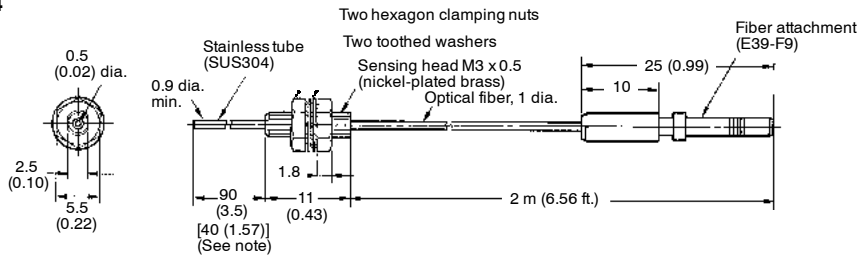

Note: The values in the brackets are for the E32-TC200F4.

Side Sensing Type

E32-T14

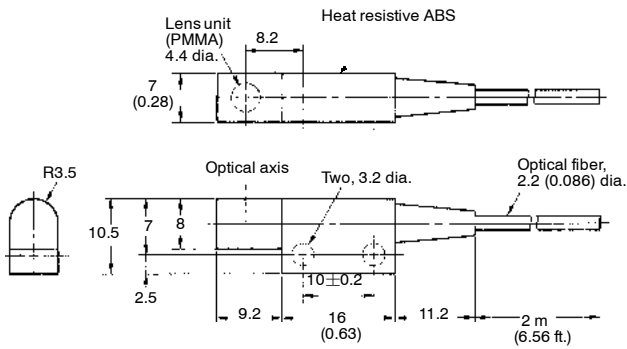

E32-T14L

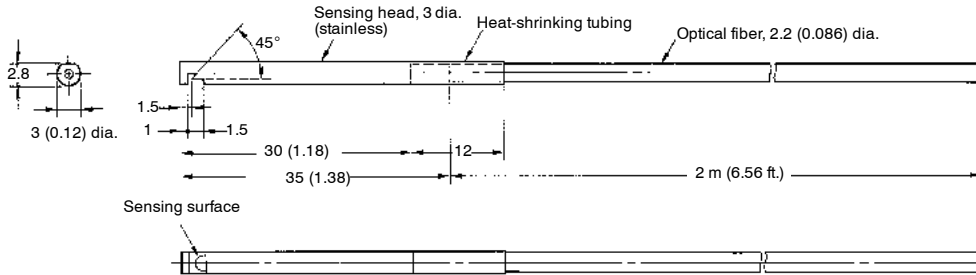

THROUGH-BEAM TYPE (CONT.)

Side Sensing Type

E32-T16

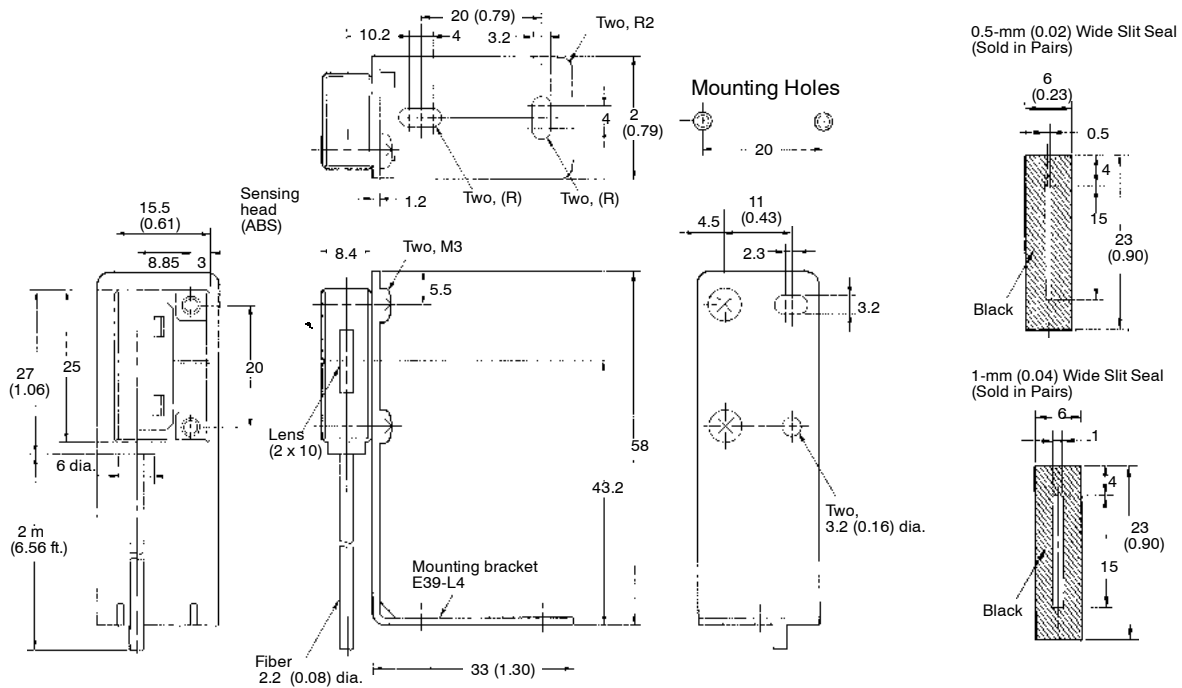

E32-T16P

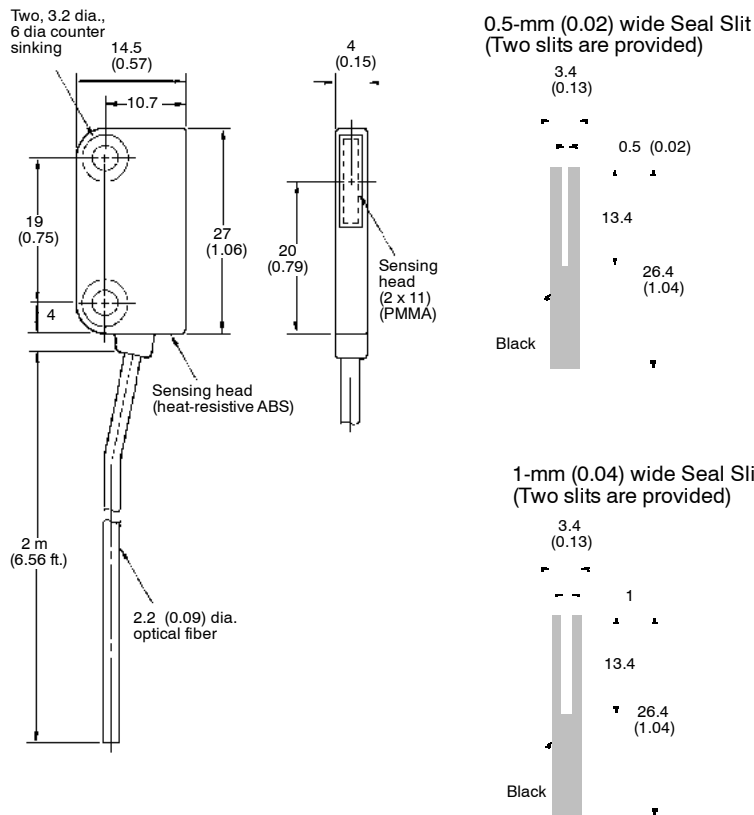

E32-T16P + E39-L94 Mounting

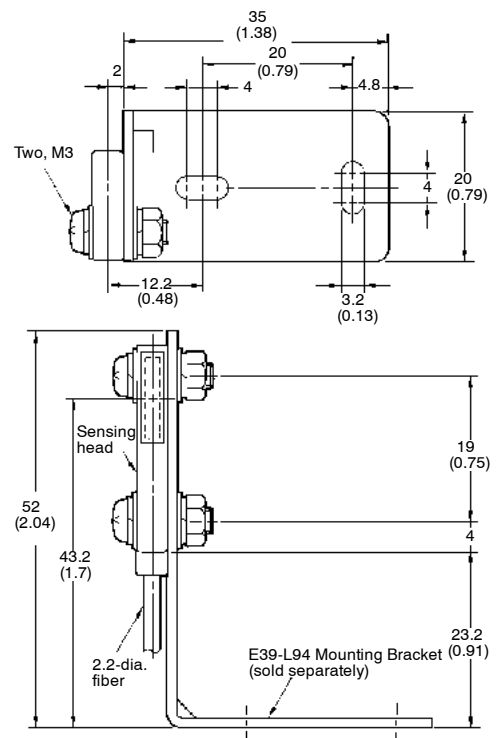

■ THROUGH-BEAM TYPE (CONT.)

Side Sensing Type

E32-T24

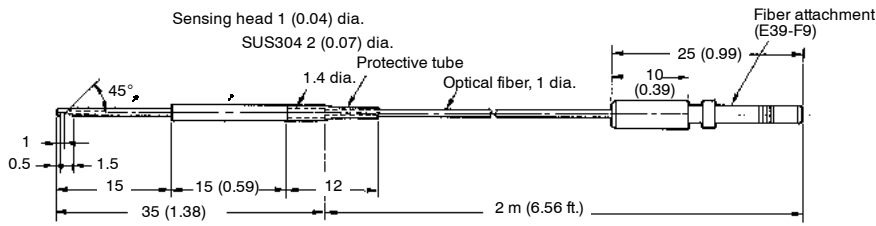

High Temperature Type

E32-T51

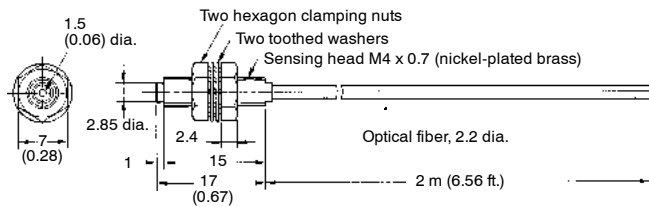

Note: Resistant temperature is 150°C (302°F). Resistant temperature is 130°C (266°F) when used continuously.

E32-T61

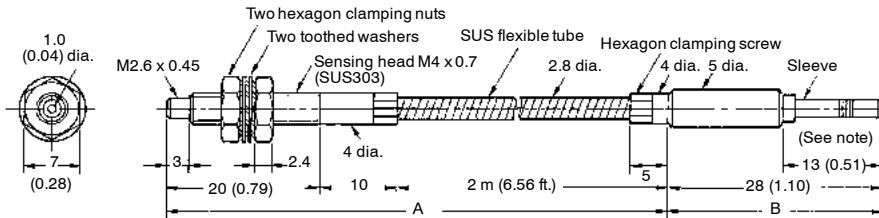

Note: Section A resists 300°C and section B (which is inserted to the amplifier) resists 110°C. The operating temperature of section B must also be within the withstand temperature range of the amplifier.

Special Purpose

E32-G14

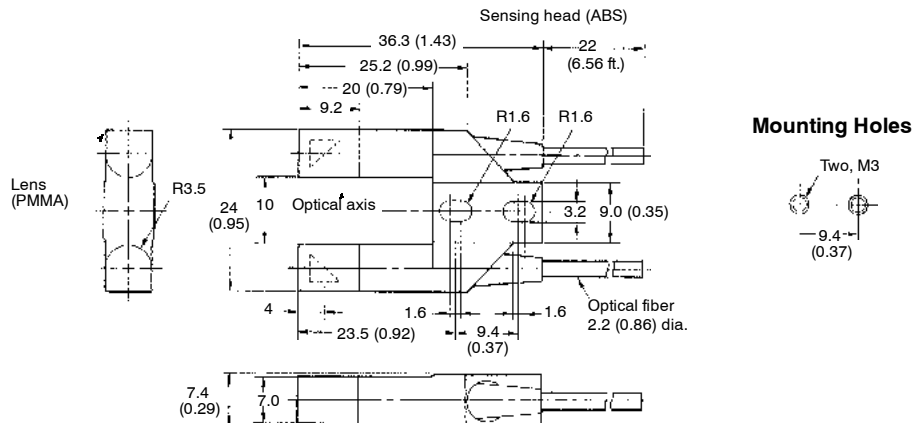

THROUGH-BEAM TYPE (CONT.)

Special Purpose

E32-M21

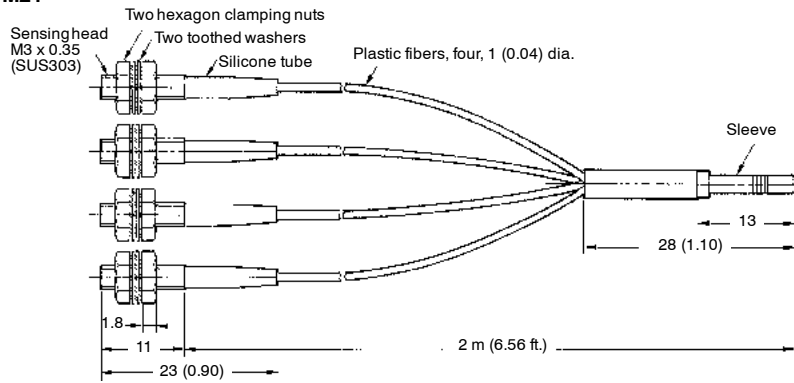

Note: One set of silicone tubes is black while the other set is gray for easy identification when they are connected to the light source and receiver.

E32-T12F

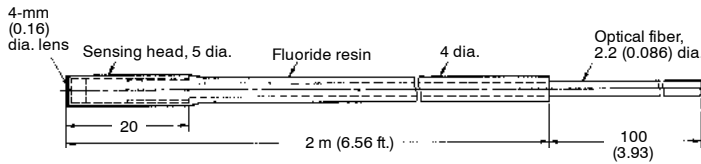

E32-T22S

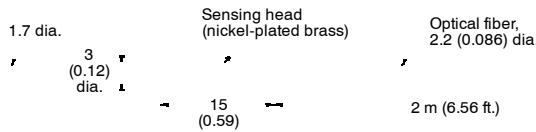

E32-T24S

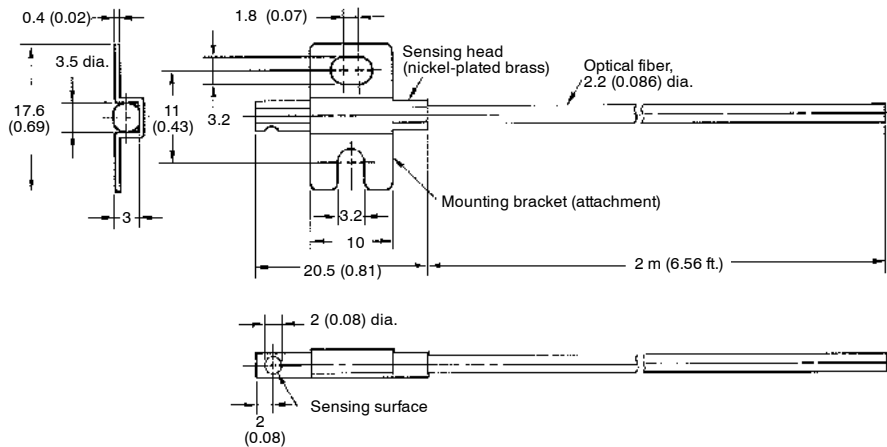

■ THROUGH-BEAM TYPE (CONT.)

Special Purpose

E32-T84S

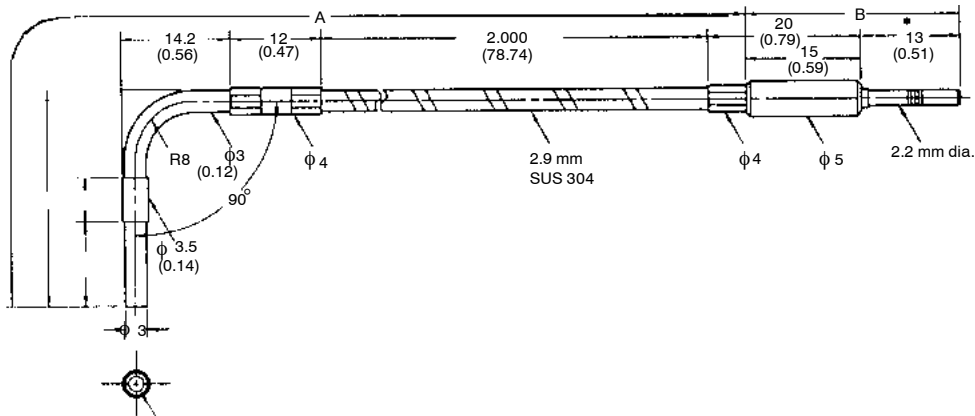

■ DIFFUSE TYPE

General Purpose

E32-CC200

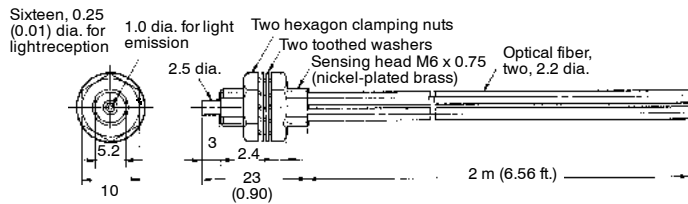

E32-D11

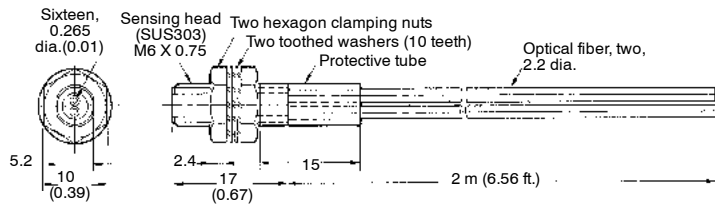

E32-D11L

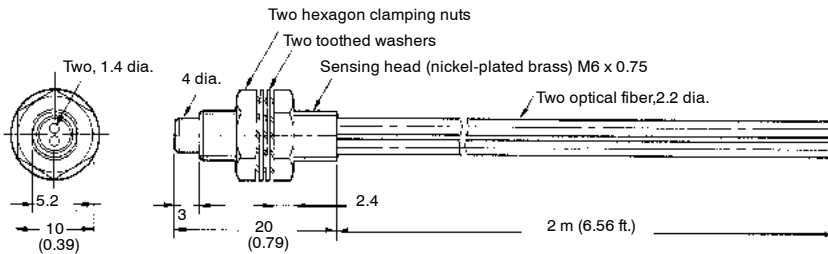

■ DIFFUSE TYPE (CONT.)

General Purpose

E32-D11R

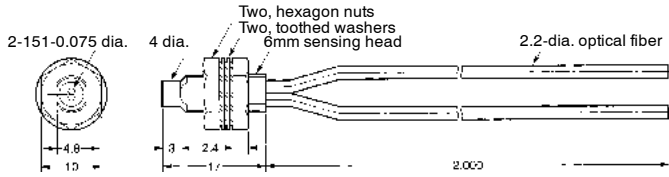

Note: The material is ADC (aluminum die-cast)

E32-D21

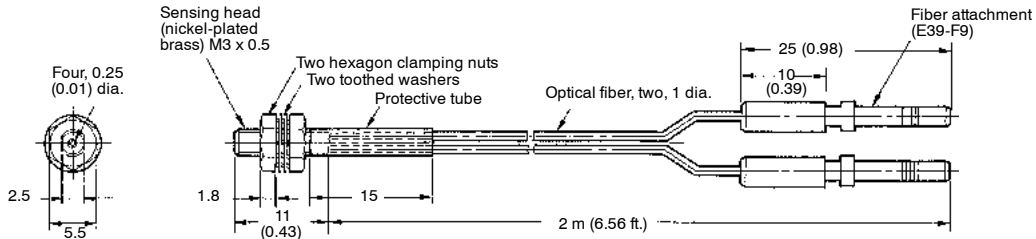

E32-D21L

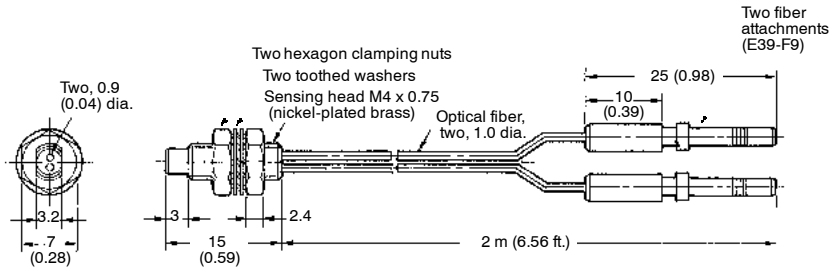

E32-D21R

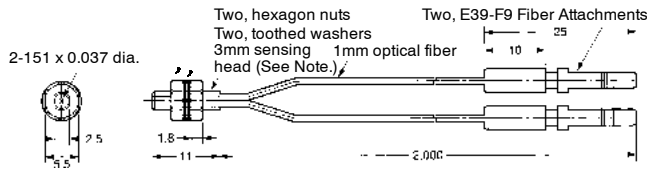

Note: The sensing head is made of nickel-plated brass.

E32-D22L

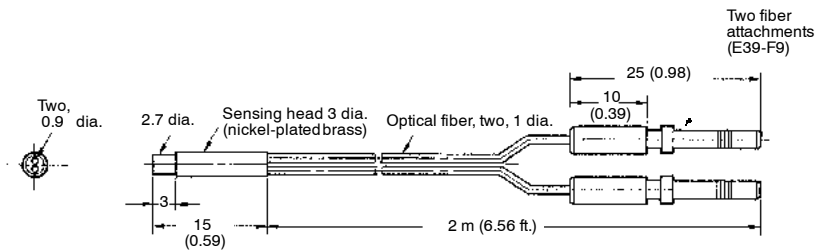

■ DIFFUSE TYPE (CONT.)

General Purpose

E32-D32

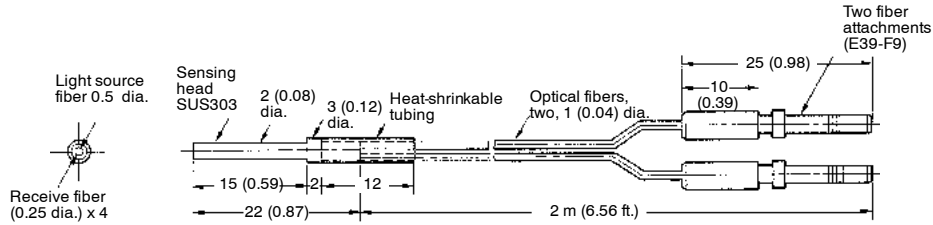

E32-D32L

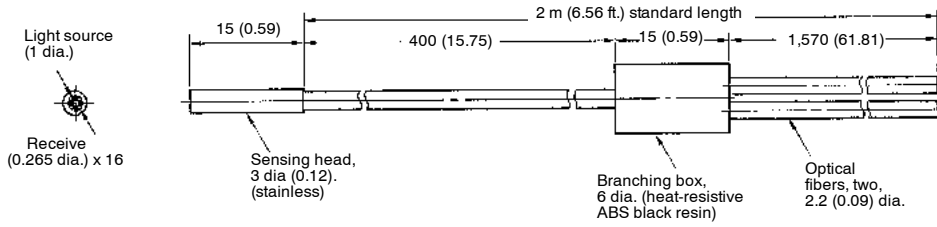

E32-DC50, E32-DC200, E32-DC500, E32-DC1000

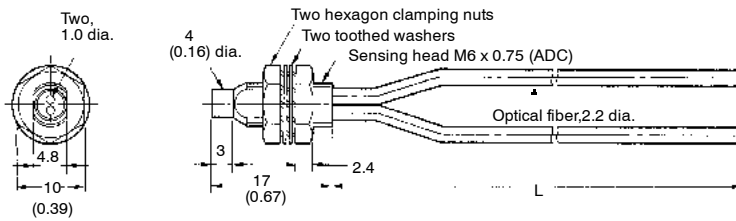

| Part number | L |
|-------------|-----------------|
| E32-DC50 | 50 cm (19 in) |
| E32-DC200 | 2 m (6.56 ft.) |
| E32-DC500 | 5 m (16.3 ft.) |
| E32-DC1000 | 10 m (32.8 ft.) |

E32-DC200C

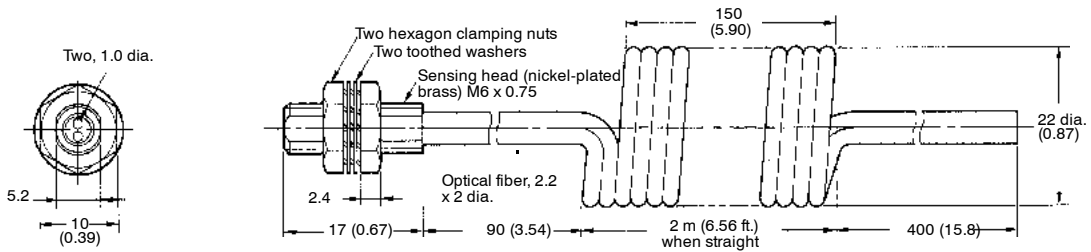

E32-DC200E

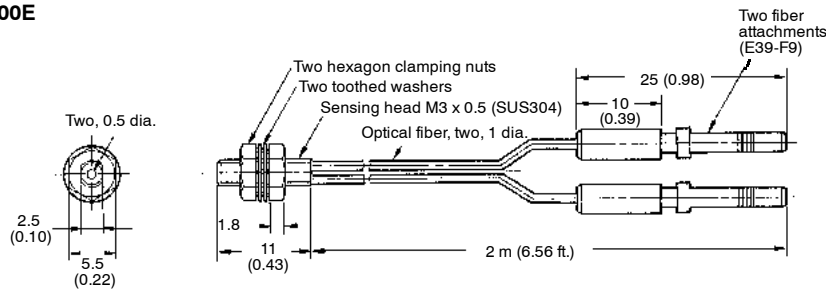

■ DIFFUSE TYPE (CONT.)

Armored Type

E32-UDAT1-3F
E32-UDAT1-6F

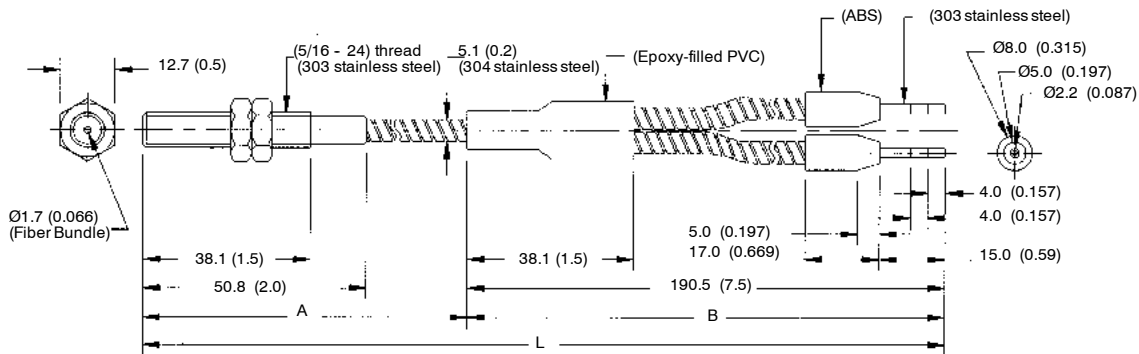

Note: 1. Distance A can withstand 150°C (302°F); Distance B can withstand 70°C (158°F); L= 3ft. or 6ft.
2. L = 3ft. for E32-UDAT1-3F; 6ft. for E32-UDAT1-6F

E32-UDBT1-3F
E32-UDBT1-6F

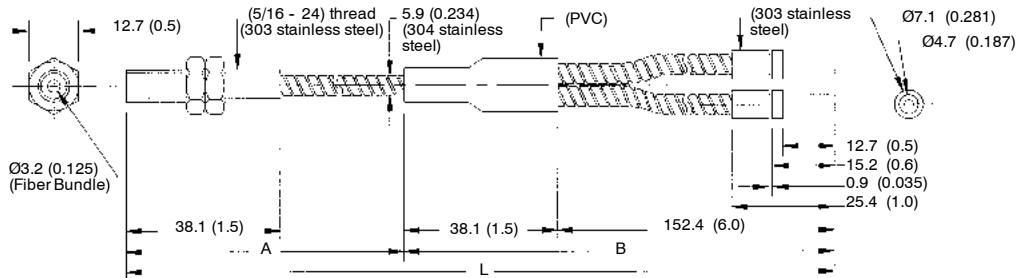

Note: 1. Distance A can withstand 200°C (392°F); Distance B can withstand 70°C (158°F)
2. L = 3ft. for E32-UDBT1-3F; 6ft. for E32-UDBT1-6F

Probe Type

E32-D33

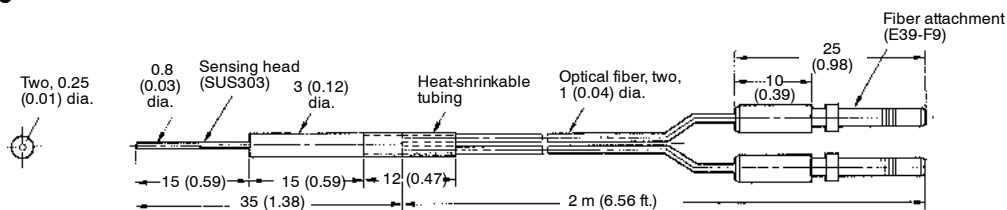

E32-DC200B
E32-DC200B4

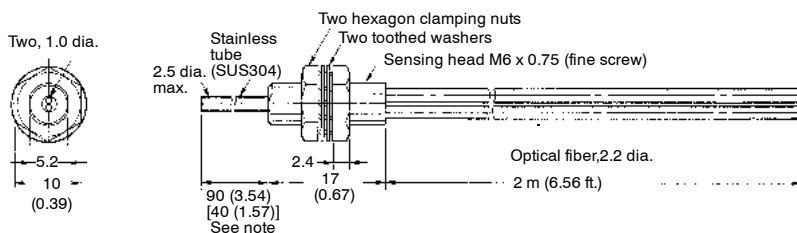

Note: The values in the brackets are for the E32-DC200B4.

■ DIFFUSE TYPE (CONT.)

Probe Type

E32-DC200D
E32-DC200D4

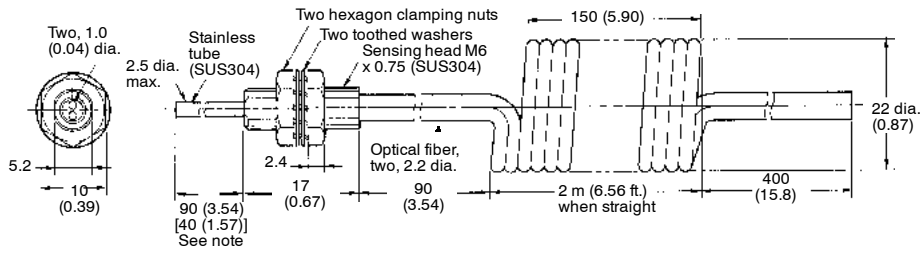

Note: The values in the brackets are for the E32-DC200D4.

E32-DC200F
E32-DC200F4

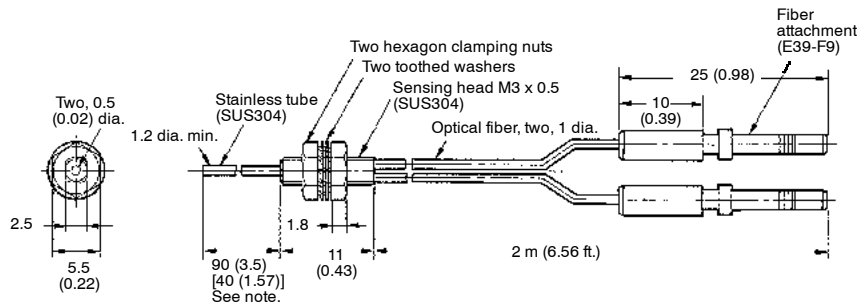

Note: The values in the brackets are for the E32-TC200F4.

E32-DC9G
E32-DC9G4

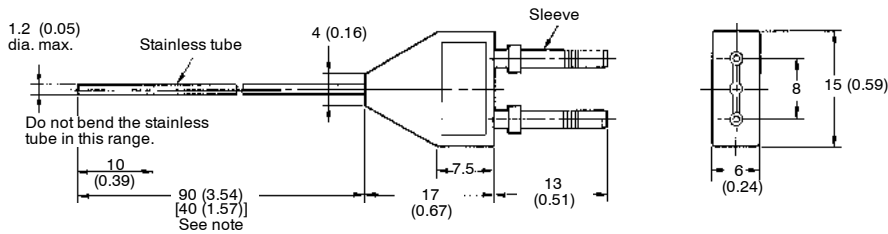

Note: The values in the brackets are for the E32-DC9G4.

Side Sensing Type

E32-D14L

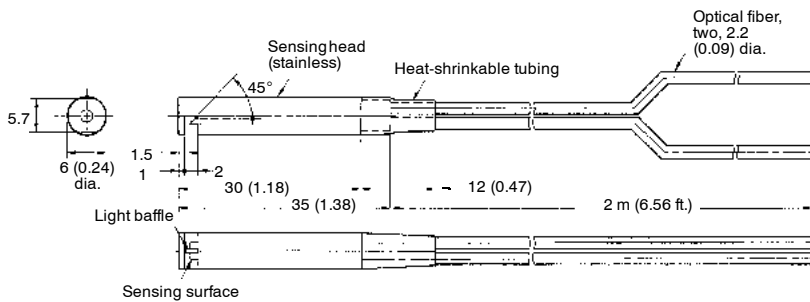

■ DIFFUSE TYPE (CONT.)

Side Sensing Type

E32-D24

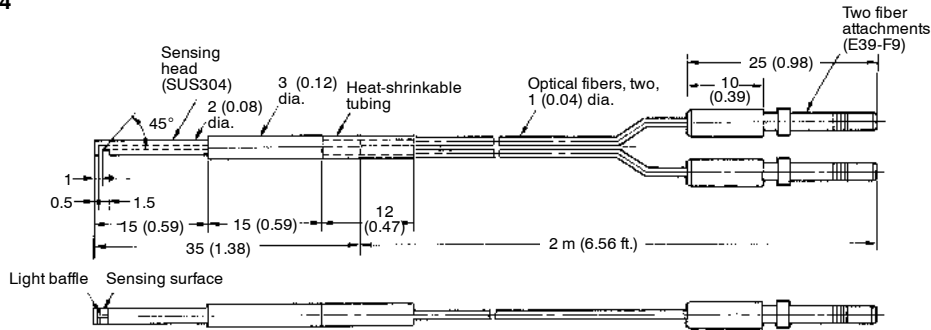

High Temperature Type

E32-D51

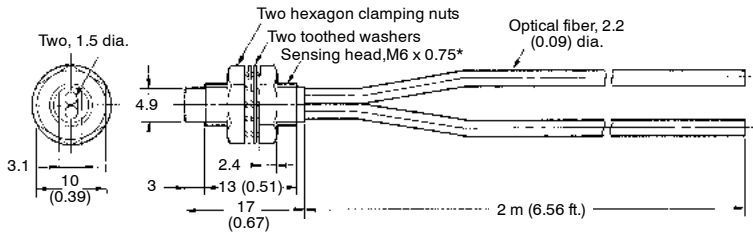

*nickel-plated brass

Note: Resistant temperature is 150°C (302°F). Resistant temperature is 130°C (266°F) when used continuously.

E32-D61

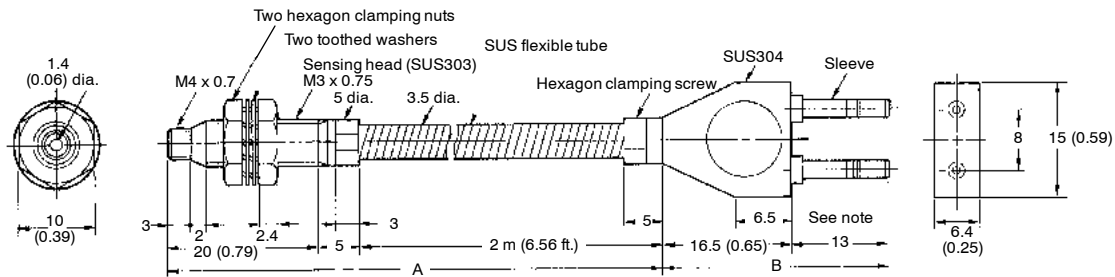

Note: Section A resists 300°C (572°F) and section B (which is inserted to the amplifier) resists 110°C (230°F). The operating temperature of section B must also be within the withstand temperature range of the amplifier.

■ DIFFUSE TYPE (CONT.)

High Temperature Type

E32-D73

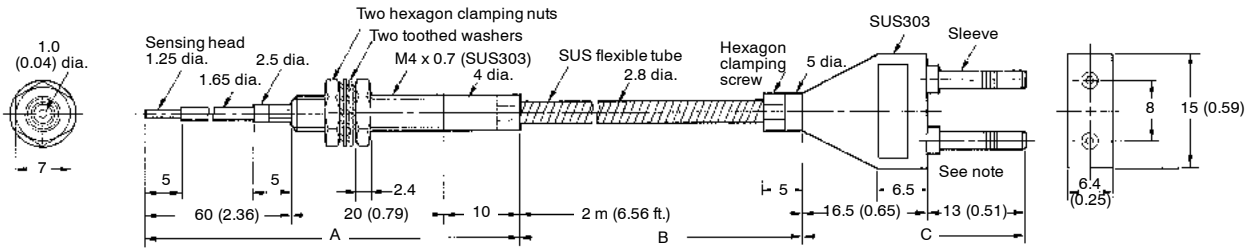

Note: Section A resists 400°C (752°F), section B resists 300°C (572°F) and section C (which is inserted to the amplifier) resists 110°C (230°F). The operating temperature of section C must also be within the withstand temperature range of the amplifier.

Convergent Type and Special Purpose

E32-D12F

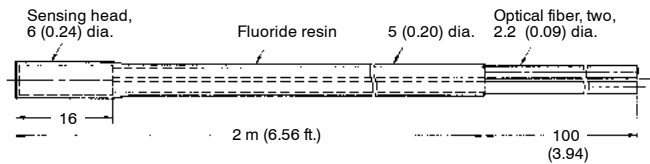

E32-L24L

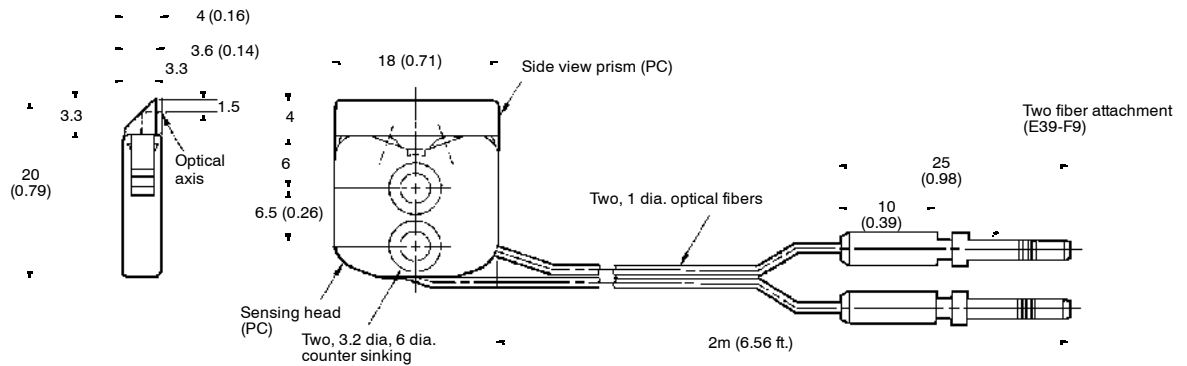

■ DIFFUSE TYPE (CONT.)

Convergent Type

E32-L25

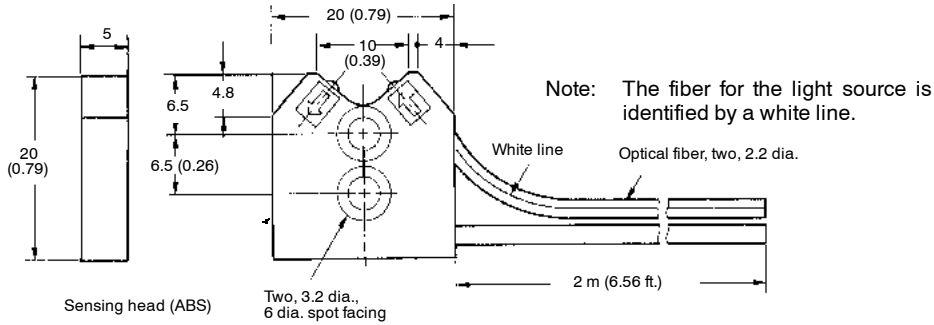

E32-L25A

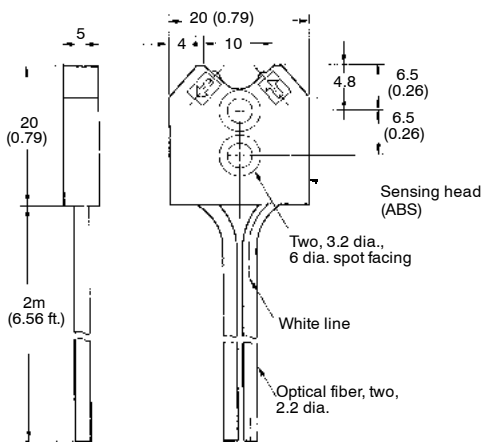

E32-L25L

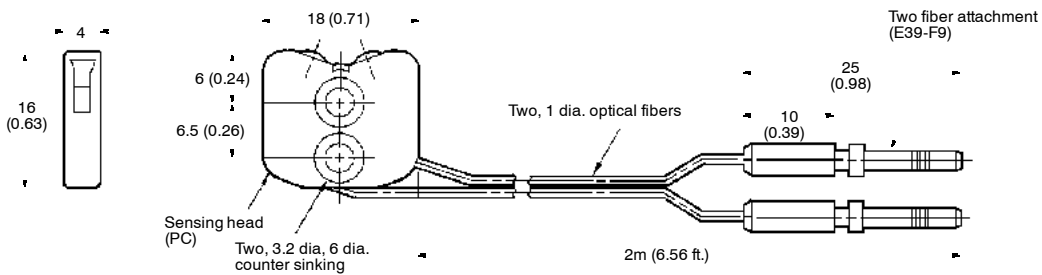

■ RETROREFLECTIVE TYPE

E32-R16

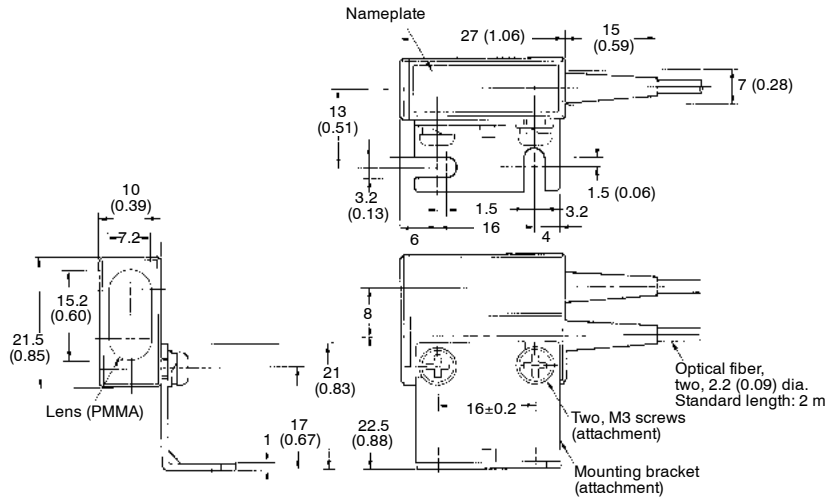

E32-R21

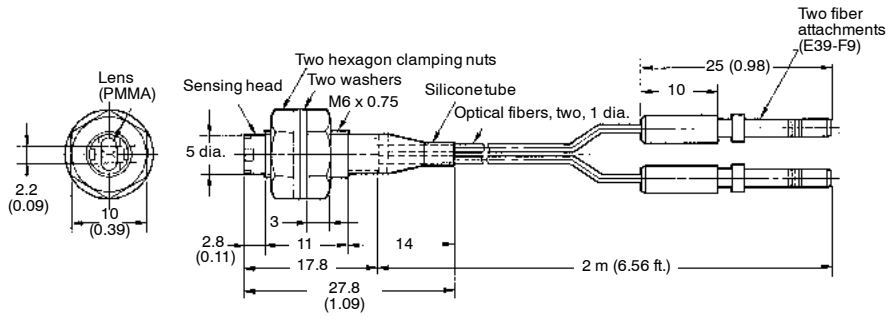

Installation

■ SENSING HEAD

Mounting Sensing Head in a Panel

Prepare a hole in the panel that can accommodate the threaded cylindrical sensing head. Be sure to place the washer in front of the mounting nut before inserting the sensing head through the hole. Tighten the front mounting nut using no more than the maximum torque recommended in the table.

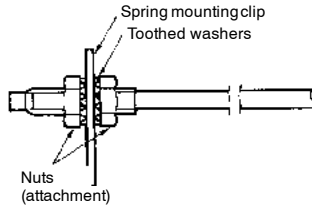

Mounting Sensing Head in a Channel

Insert the sensing head at the desired location in the channel as shown in the illustration, then use a set screw to fasten the head in place. Apply no more than 2.6 in-lb of force in tightening the set screw.

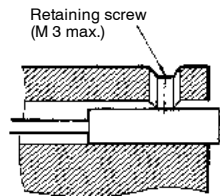

Tightening Torque

Use a proper-sized wrench and do not exceed the torque recommended for the sensing head.

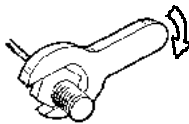

| Sensing heads | Maximum torque |
|----------------------|----------------|
| M3 and M4 threads | 6.88 in-lb |
| M6 threads | 8.66 in-lb |
| 2 mm dia., no thread | 2.6 in-lb |
| 3 mm dia., no thread | 2.6 in-lb |
| E32-D14L | 8.66 in-lb |
| E32-T12F | 6.88 in-lb |
| E32-D12F | 6.88 in-lb |
| E32-T16 | 4.33 in-lb |
| E32-R21 | 5.2 in-lb |
| E32-M21 | 4.33 in-lb |
| E32-L25A | 6.88 in-lb |

■ CUTTING FIBER

Insert a fiber into the Fiber and determine the length of the fiber to be cut.

Press down the Fiber Cutter in a single stroke to cut the fiber.

When the fiber is cut, an insertion mark is inscribed on the fiber.

For a 2.2-mm dia. standard fiber only.

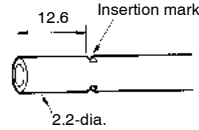

Insert a fiber into the Fiber Cutter in the direction indicated by the arrow (refer to the following figure).

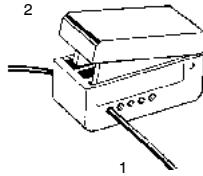

The cutting holes cannot be used twice. If the same hole is used twice, the cutting face of the fiber will be rough and the sensing distance will be reduced. Always use an unused hole.

Use either one of the two holes on the right (refer to the following figure) to cut a thin fiber as follows:

1. An attachment is temporarily fitted to a thin fiber before shipment.

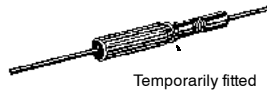

2. Secure the attachment after adjusting the position of it in the direction indicated by the arrow.
3. Insert the fiber into the E39-F4 to cut.

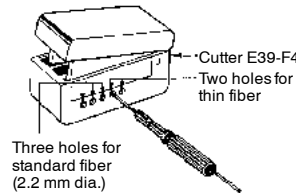

Note: Insert the fiber in the direction indicated by the arrow.

■ FIBER UNITS WITH 90° BEND IN STAINLESS STEEL PROBE

Applicable Models

E32-TC200B/TC200F/DC200F

Appearance

Stainless Steel Probe with a 90° Bend at the Tip

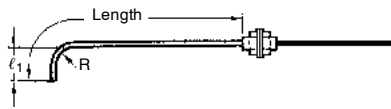

| Bending radius | $l_1 (+1)$ | |
|----------------|------------|---------|
| R 5.0 | 10.0 mm | 15.0 mm |
| R 7.5 | 12.5 mm | 17.5 mm |
| R 10.0 | 15.0 mm | 20.0 mm |
| R 12.5 | 17.5 mm | 22.5 mm |

The length overall is 120 mm max.

Note: If larger l_1 is required, use the E39-F11 Sleeve Bender.

Stainless Steel Probe with a 90° Bend at the Base

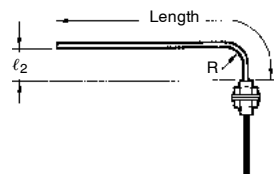

| Bending radius | $l_2 (+1)$ | |
|----------------|------------|---------|
| R 5.0 | 5.0 mm | 10.0 mm |
| R 7.5 | 7.5 mm | 17.5 mm |
| R 10.0 | 10.0 mm | 20.0 mm |
| R 12.5 | 12.5 mm | 22.5 mm |

The length overall is 120 mm max.

Note: If larger l_2 is required, use the E39-F11 Sleeve Bender.

Sensing Distance for Probes with 90° Bends

| Part number | Amplifier | Bending radius | | | | |
|-------------|-----------|----------------|--------|--------|--------|--------|
| | | Standard | R5.0 | R7.5 | R10.0 | R12.5 |
| E32-TC200B | E3X-H11 | 400 mm | 260 mm | 330 mm | 360 mm | 400 mm |
| | E3X-A□□ | 180 mm | 110 mm | 140 mm | 160 mm | 180 mm |
| E32-TC200F | E3X-H11 | 100 mm | 55 mm | 100 mm | 100 mm | 100 mm |
| | E3X-A□□ | 50 mm | 30 mm | 50 mm | 50 mm | 50 mm |
| E32-DC200F | E3X-H11 | 36 mm | 30 mm | 36 mm | 36 mm | 36 mm |
| | E3X-A□□ | 18 mm | 10 mm | 18 mm | 18 mm | 18 mm |

■ BENDING RADIUS

E39-F11 Sleeve Bender

The bending radius of the stainless probe should be as large as possible. The smaller the bending radius becomes, the shorter the sensing distance will be.

Insert the tip of the stainless probe to the Sleeve Bender and bend the stainless probe slowly along the curve of the Sleeve Bender (refer to the figure).

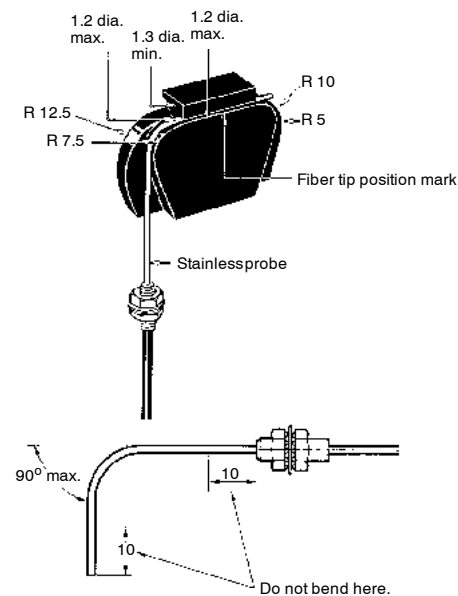

INSTALLING FIBER CABLES

Bends in Fiber cables

Plastic and glass filament fiber cables may be bent to avoid obstacles on the way to the sensing site. Here are some guidelines about the location of cable bends: The first bend must be at least 20 mm (0.79 in) away from where the cables enter the amplifier. The last bend must be at least 20 mm (0.79 in) bending the sensing head. We recommend a 25 mm (1.0 in) minimum radius for a right angle bend to maintain the rated sensing distance. The sharpest allowable right angle bend is over a 10 mm (0.39 in) radius, but this will result in a shorter sensing distance. Refer to the bending radius graph.

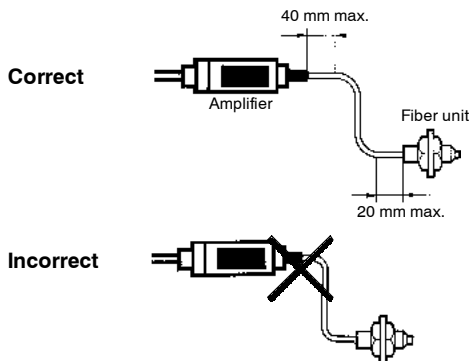

Do not apply excess force on the Fiber Units.

Do not pull or press the Fiber Units. The Fiber Units have a withstand force of 1 kg or 3 kg (pay utmost attention because the fibers are thin).

Do not bend the Fiber Units beyond the permissible bending radius.

Do not bend the edge of the Fiber Units.

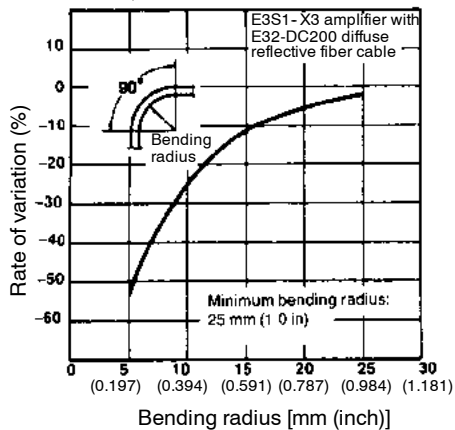

Proper Supports for Cables

To support the fiber cable between the sensing site and the amplifier, mount the cable using a nylon strap or cable tie. Do not use a U-shaped strap that will compress or put stress on the fiber cable. To prevent damage from excessive vibration, take up the fiber in a loop as shown below.

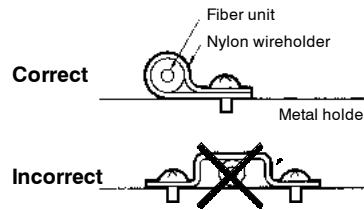

The Fiber Head could be broken by excessive vibration. To prevent this, the following is effective:

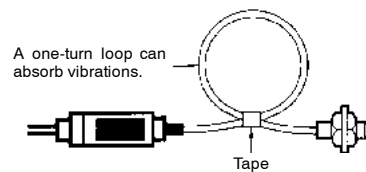

LONGER FIBER-OPTIC CABLES

Applicable Models

- E32-TC200/-DC200
- E32-TC200B/-DC200B
- E32-TC200E/-DC200E
- E32-TC200F/-DC200F
- E32-TC200A

Appearance

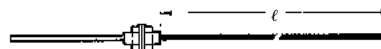

The length can be ordered in increments of 1 m between 6 m min. and 20 m max. (2-m and 5-m fiber length types are standard for E32-TC200, E32-DC200.)

E39-F10 Fiber Connector

Use the following procedure (refer to the figure) to connect fibers via the Fiber Connector.

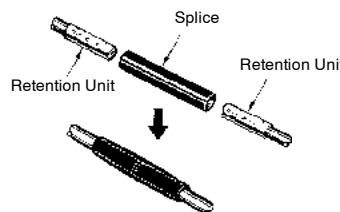

Each fiber should be as close as possible before they are connected.

Sensing distance will be reduced by approximately 25% when fibers are connected.

Only fibers with 2.2 mm dia. can be connected.

■ SPECIAL HANDLING

E32-D51/-T51 Heat-Resistant Fiber

The bending radius of the fibers should be 35 mm min.

Connecting fibers via the E39-F10 Fiber Connector is not possible.

The withstand temperature of the Heat-Resistant Fibers is 150°C max. In continuous operation, the ambient temperature should be 130°C max.

E32-T14/-T51

If the sensor is ON because some object in front of the lenses reflects light, attach the black seals (sold together) to the lenses.

E32-T14/-G14



E32-L25 (A) Wafer Sensor

Insert the fiber with a white line into the light projection side of the Amplifier.

The tightening force of the sensor head is 8 kgf • cm (0.75 N • m).

Avoid places where water could be sprayed onto the E32-L25(A).

E32-T16 Slit Seal (Attachment)

Peel the E32-T16 Slit Seal off the ground paper and affix the Slit Seal to the sensing face of the sensor so that the corners of the Slit Seal fit in with the corners of the sensing face. To sense an object at a distance of 30 cm max., a 0.5-mm wide Slit Seal must be used.

E32-T16 Sensing Head

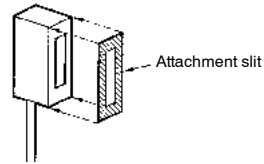

NOTE: DIMENSIONS SHOWN ARE IN MILLIMETERS. To convert millimeters to inches divide by 25.4.

OMRON®

OMRON ELECTRONICS LLC

One East Commerce Drive
Schaumburg, IL 60173

1-800-55-OMRON

OMRON ON-LINE

Global - <http://www.omron.com>
USA - <http://www.omron.com/oei>
Canada - <http://www.omron.com/oci>

OMRON CANADA, INC.

885 Milner Avenue
Scarborough, Ontario M1B 5V8

416-286-6465