

## RF to IF Single Downconverting Mixer

2000MHz to 2900MHz

### GENERAL DESCRIPTION

This document describes the specification<sup>2</sup> for the IDTF1763 Zero-Distortion™ Highband RF to IF Single Downconverting Mixer. This device is part of a series of mixers using lowside or highside LO injection options for all UTRA frequency bands. See the Part# Matrix for the detail of all devices in this series.

The F1763 single channel device is designed to operate with a single 5V supply. It is optimized for operation in a Multi-mode, Multi-carrier BaseStation Receiver for frequency bands from 2000MHz - 2900MHz using either lowside or highside LO. IF frequencies from 50MHz to 500MHz are supported. Nominally, the device offers +42 dBm Output IP3 with 200mA of  $I_{cc}$ .

### COMPETITIVE ADVANTAGE

In typical basestation receivers, the RF to IF mixer dominates the linearity performance for the entire receive system. The Zero-Distortion™ family of mixers dramatically improve the maximum signal levels ( $IM_3$  tones) that the BTS can withstand at a desired Signal to Noise Ratio (SNR.) Zero-Distortion™ technology allows realization of either benefit. In basestation transmitters, digital pre-distortion (DPD) is employed to improve the Transmitter performance. By utilizing an ultra-linear mixer in the DPD RX path, such as the IDTF1763, the ACLR and/or power consumption of the full Tx system can be improved significantly. This is because the F1763 can directly drive an ADC through an Anti-Alias filter. Downstream amplification is not necessary in the DPD application.

- ✓  $IP3_0$ : ↑ **12 dB**
- ✓ Dissipation: ↓ **10%**
- ✓ Allows for higher RF gain improving **Sensitivity**
- ✓ Eliminates the need for an ADC driver or IF VGA in DPD linearization path



### FEATURES

- Ideal for Multi-Carrier Systems
- Lowside or Highside LO
- 11.7dB Gain
- Ultra linear +45dBm  $IP3_0$  using HS LO or +42dBm  $IP3_0$  using LS LO
- 9.7 dB NF
- 200  $\Omega$  output impedance
- Wide flat performance IF BW
- Drives ADC directly for DPD applications
- Low Power Consumption
- 5x5 20 pin package
- Standby Mode

### DEVICE BLOCK DIAGRAM

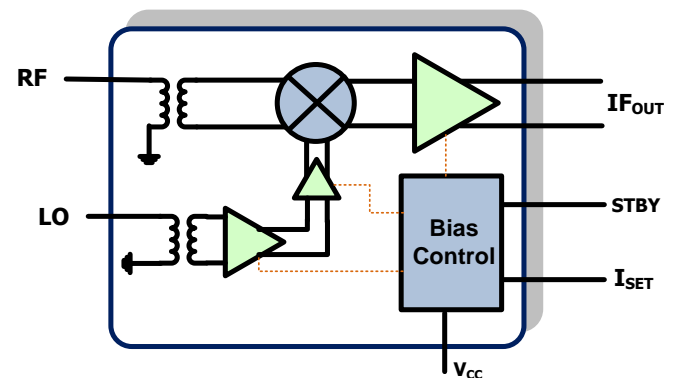

### ORDERING INFORMATION

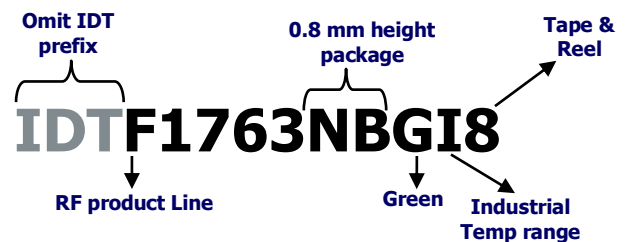

### PART# MATRIX

| Part# | RF Range    | UTRA bands                                       | IF freq range | Typ. Gain | Injection |
|-------|-------------|--|---------------|-----------|-----------|
| F1701 | 600 - 1060  | 5,6,8,12,13,14,17,18,19,20,26                    | 70 - 300      | 11.8      | Both      |
| F1751 | 1400 - 2500 | 1,2,3,4,9,10,11,21,23,24,25,33,34,35,36,37,39,40 | 50 - 500      | 11.8      | Both      |
| F1763 | 2000 - 2900 | 7,38,40,41                                       | 50 - 500      | 11.7      | Both      |



**ABSOLUTE MAXIMUM RATINGS**

|   |                                     |
|---|-------------------------------------|
| VCC to GND  | -0.3V to +5.5V                      |
| STBY  | -0.3V to (VCC + 0.3V)               |
| IF_OUT+, IF_OUT-, RF_IN   | -0.3V to (VCC + 0.3V)               |
| LO_IN   | -0.3V to +0.3V                      |
| IF_SET to GND, IF_BIAS to GND   | -0.3V to +1.2V                      |
| RF Input Power  | +20dBm                              |
| Continuous Power Dissipation  | 1.3W                                |
| $\theta_{JA}$ (Junction – Ambient)  | +40°C/W                             |
| $\theta_{JC}$ (Junction – Case) The Case is defined as the exposed paddle | +3°C/W                              |
| Operating Temperature Range (Case Temperature)                            | $T_C = -40^\circ\text{C}$ to +105°C |
| Maximum Junction Temperature  | 150°C                               |
| Storage Temperature Range   | -65°C to +150°C                     |
| Lead Temperature (soldering, 10s)   | +260°C                              |

*Stresses above those listed above may cause permanent damage to the device. Functional operation of the device at these or any other conditions above those indicated in the operational section of this specification is not implied. Exposure to absolute maximum rating conditions for extended periods may affect device reliability.*



**IDTF1763 RECOMMENDED OPERATING CONDITIONS**

| Parameter                   | Comment   | Symbol            | min  | typ | max  | Units |
|-----------------------------|---|-------------------|------|-----|------|-------|
| Supply Voltage(s)           | All V <sub>CC</sub> pins  | V <sub>CC</sub>   | 4.75 |     | 5.25 | V     |
| Operating Temperature Range | Case Temperature  | T <sub>CASE</sub> | -40  |     | +105 | degC  |
| RF Freq Range               | Sets LO Range   | F <sub>RF1</sub>  | 2300 |     | 2700 | MHz   |
| Oversample RF Range         | <ul style="list-style-type: none"><li>▪ Measure gain at 200MHz IF</li><li>▪ LO = 1800MHz, 2700MHz</li></ul> | F <sub>RF2</sub>  | 2000 |     | 2900 |       |
| LO Range                    |   | F <sub>LO</sub>   | 1800 |     | 3000 |       |
| IF Freq Range               |   | F <sub>IF</sub>   | 50   |     | 500  |       |



**RF to IF Single Downconverting Mixer**

**2000MHz to 2900MHz**

**IDTF1763 SPECIFICATION**

Refer to Typical Application Circuit when operated with  $V_{CC} = +5.0V$ ,  $T_C = +25^\circ C$ ,  $F_{RF} = 2500\text{ MHz}$ ,  $F_{IF} = 200\text{ MHz}$ ,  $F_{LO} = 2300\text{ MHz}$ ,  $P_{LO} = 0\text{ dBm}$ , output power = +1dBm per tone, STBY = GND unless otherwise noted. Transformer loss is de-embedded unless otherwise noted.

| Parameter                | Comment   | Symbol           | min                   | typ         | max                    | units   |
|--------------------------|---|------------------|-----------------------|-------------|------------------------|---------|
| Logic Input High         | For Standby Pin   | $V_{IH}$         | <b>2</b>              |             |                        | V       |
| Logic Input Low          | For Standby Pin   | $V_{IL}$         |                       |             | <b>0.8<sup>1</sup></b> | V       |
| Logic Current            | For Standby Pin   | $I_{IH}, I_{IL}$ | <b>-1</b>             |             | <b>+1</b>              | $\mu A$ |
| Supply Current           | Total $V_{CC}$  | $I_{SUPP}$       |                       | <b>200</b>  | <b>215</b>             | mA      |
| Supply Current           | Standby Mode<br>▪ STBY = $V_{IH}$   | $I_{STBY}$       |                       | <b>25</b>   | <b>33</b>              | mA      |
| LO Power                 |   | $P_{LO}$         | <b>-3<sup>2</sup></b> |             | <b>+3</b>              | dBm     |
| Settling Time            | <ul style="list-style-type: none"> <li>Pin = -13 dBm</li> <li>Gate STBY from <math>V_{IH}</math> to <math>V_{IL}</math></li> <li>Time for IF Signal to settle to within 1 dB of final value</li> </ul>                    | $T_{SETT}$       |                       | 130         |                        | nsec    |
| Gain                     | <ul style="list-style-type: none"> <li><math>F_{RF} = 2000\text{MHz}</math></li> <li><math>F_{LO} = 1800\text{MHz}</math></li> </ul>  | $G_{LB}$         |                       | <b>12.2</b> |                        | dB      |
|                          | <ul style="list-style-type: none"> <li><math>F_{RF} = 2500\text{MHz}</math></li> <li><math>F_{LO} = 2300\text{MHz}</math></li> </ul>  | $G_{MB}$         | <b>10.7</b>           | <b>11.7</b> | <b>13</b>              |         |
|                          | <ul style="list-style-type: none"> <li><math>F_{RF} = 2900\text{MHz}</math></li> <li><math>F_{LO} = 2700\text{MHz}</math></li> </ul>  | $G_{HB}$         |                       | <b>11</b>   |                        |         |
| Noise Figure             | <ul style="list-style-type: none"> <li><math>F_{RF} = 2100\text{MHz}</math></li> <li><math>F_{LO} = 1900\text{MHz}</math></li> </ul>  | $NF_{LB}$        |                       | 9.2         |                        | dB      |
|                          | <ul style="list-style-type: none"> <li><math>F_{RF} = 2500\text{MHz}</math></li> <li><math>F_{LO} = 2300\text{MHz}</math></li> </ul>  | $NF_{MB}$        |                       | 9.7         |                        |         |
|                          | <ul style="list-style-type: none"> <li><math>F_{RF} = 2900\text{MHz}</math></li> <li><math>F_{LO} = 2700\text{MHz}</math></li> </ul>  | $NF_{HB}$        |                       | 10.9        |                        |         |
| NF w/Blocker             | <ul style="list-style-type: none"> <li>+100 MHz offset blocker</li> <li><math>P_{IN} = +4\text{ dBm}</math></li> </ul>  | $NF_{BLK}$       |                       | 20          |                        | dB      |
| Output IP3               | <ul style="list-style-type: none"> <li><math>F_{RF1} = 2100\text{MHz}</math></li> <li><math>F_{LO} = 1900\text{MHz}</math></li> <li><math>P_{IN} = -10\text{dBm}</math> per tone</li> <li>5MHz Tone Separation</li> </ul> | $OIP3_{LB}$      | 35                    | 40          |                        | dBm     |
|                          | <ul style="list-style-type: none"> <li><math>F_{RF1} = 2500\text{MHz}</math></li> <li><math>F_{LO} = 2300\text{MHz}</math></li> <li><math>P_{IN} = -10\text{dBm}</math> per tone</li> <li>5MHz Tone Separation</li> </ul> | $OIP3_{MB}$      | <b>34</b>             | <b>42</b>   |                        |         |
|                          | <ul style="list-style-type: none"> <li><math>F_{RF1} = 2500\text{MHz}</math></li> <li><math>F_{LO} = 2700\text{MHz}</math></li> <li><math>P_{IN} = -10\text{dBm}</math> per tone</li> <li>5MHz Tone Separation</li> </ul> | $OIP3_{MB}$      |                       | 45          |                        |         |
|                          | <ul style="list-style-type: none"> <li><math>F_{RF1} = 2900\text{MHz}</math></li> <li><math>F_{LO} = 2700\text{MHz}</math></li> <li><math>P_{IN} = -10\text{dBm}</math> per tone</li> <li>5MHz Tone Separation</li> </ul> | $OIP3_{HB}$      | 35                    | 40          |                        |         |
| 2RF – 2LO rejection      | <ul style="list-style-type: none"> <li><math>P_{RF} = -10\text{dBm}</math></li> <li>Frequency = 2400MHz</li> </ul>  | 2x2              |                       | -74         | -65                    | dBc     |
| 2 <sup>nd</sup> Harmonic | <ul style="list-style-type: none"> <li><math>P_{out} = -3\text{dBm}</math></li> </ul>   | H2               |                       | -72         | -67                    | dBc     |



**RF to IF Single Downconverting Mixer**

**2000MHz to 2900MHz**

**IDTF1763 SPECIFICATION (CONTINUED)**

Refer to Typical Application Circuit when operated with  $V_{CC} = +5.0V$ ,  $T_C = +25^\circ C$ ,  $F_{RF} = 2500$  MHz,  $F_{IF} = 200$  MHz,  $F_{LO} = 2300$  MHz,  $P_{LO} = 0$  dBm, output power = +1dBm per tone, STBY = GND unless otherwise noted. Transformer loss is de-embedded unless otherwise noted.

| Parameter                     | Comment   | Symbol          | min       | typ  | max | units    |
|-------------------------------|---|-----------------|-----------|------|-----|----------|
| IM2 Sum Product (IM2+)        | <ul style="list-style-type: none"> <li>▪ Pout = -3 dBm each tone</li> <li>▪ <math>F_{IF1} = 200</math> MHz, <math>F_{IF2} = 205</math> MHz</li> <li>▪ IM2 Product = 405 MHz</li> </ul>                                    | IM2+            |           | -67  | -61 | dBc      |
| IM2 Diff Product (IM2-)       | <ul style="list-style-type: none"> <li>▪ Pout = -3 dBm each tone</li> <li>▪ <math>F_{IF1} = 200</math> MHz, <math>F_{IF2} = 205</math> MHz</li> <li>▪ IM2 Product = 5 MHz</li> </ul>                                      | IM2-            |           | -82  | -76 | dBc      |
| 1dB output compression        | Output referred   | $P1dB_O$        | <b>17</b> | 20.9 |     | dBm      |
| 1dB input compression         | Input referred  | $P1dB_I$        |           | 10.2 |     | dBm      |
| Gain Comp. w/blocker          | <ul style="list-style-type: none"> <li>▪ Unmodulated blocker</li> <li>▪ <math>P_{in} = +4</math> dBm, -100MHz offset</li> <li>▪ Signal Pin Tone = -20dBm</li> <li>▪ Measure <math>\Delta</math> gain of signal</li> </ul> | $\Delta G_{AC}$ |           | 0.1  | 0.2 | dB       |
| Gain Ripple                   | <ul style="list-style-type: none"> <li>▪ Fixed LO = 1650 MHz</li> <li>▪ RF = 1700 to 2100 MHz</li> <li>▪ IF = 50 to 450MHz</li> </ul>   |                 |           | 2.7  | 3   | dB       |
| RF Input Impedance            | Single Ended  | $Z_{RF}$        |           | 50   |     | $\Omega$ |
| LO port Impedance             | Single Ended  | $Z_{LO}$        |           | 50   |     |          |
| IF Output Impedance           | Differential  | $Z_{IF}$        |           | 200  |     |          |
| RF Input Return Loss          | Single Ended  | $RF_{RL}$       | 15        | 25   |     | dB       |
| LO port Return Loss           | Single Ended  | $LO_{RL}$       | 12        | 16   |     | dB       |
| IF Output Return Loss         | Differential  | $IF_{RL}$       | 10        | 13   |     | dB       |
| LO to IF leakage <sup>2</sup> |   | $ISO_{LI}$      |           | -34  | -27 | dBm      |
| RF to IF isolation            | Referenced to Pin = -10dBm  | $ISO_{RI}$      |           | -44  | -38 | dBc      |
| LO to RF leakage              |   | $ISO_{LR}$      |           | -49  | -38 | dBm      |

1 – Items in min/max columns in *bold italics* are Guaranteed by Test

2 – All other Items in min/max columns are Guaranteed by Design Characterization



**TYPICAL OPERATING CONDITIONS**

Unless otherwise noted, the following conditions apply to the Typ Ops Graphs:

- $V_{CC} = +5.0V$
- $T_C = +25^{\circ}C$
- $F_{RF} = 2500\text{ MHz}$
- $F_{IF} = 200\text{ MHz}$
- $F_{LO} = 2300\text{ MHz}$
- $P_{LO} = 0\text{ dBm}$
- $P_{in} = -10\text{ dBm}$  per tone
- $STBY = GND$
- Transformer loss is de-embedded for Gain, Output P1dB and OIP3 Graphs



**TOCs [IF = 200MHz, HIGH SIDE INJECTION] Gain, OIP3 (1)**

**Gain vs. T<sub>CASE</sub>**

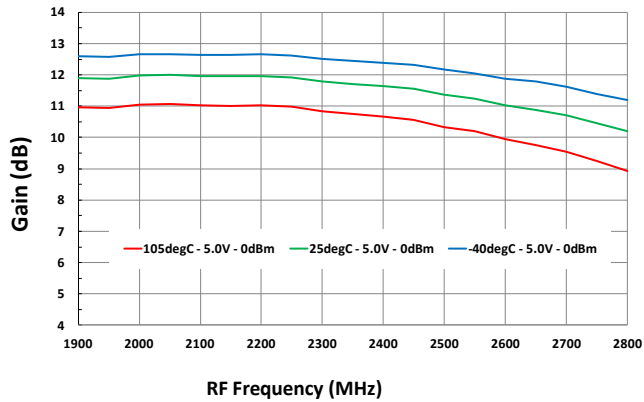

**Gain vs. Lo Level**

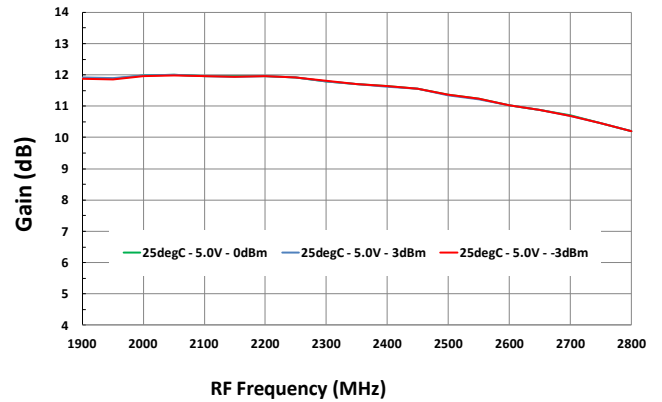

**Gain vs. Vcc**

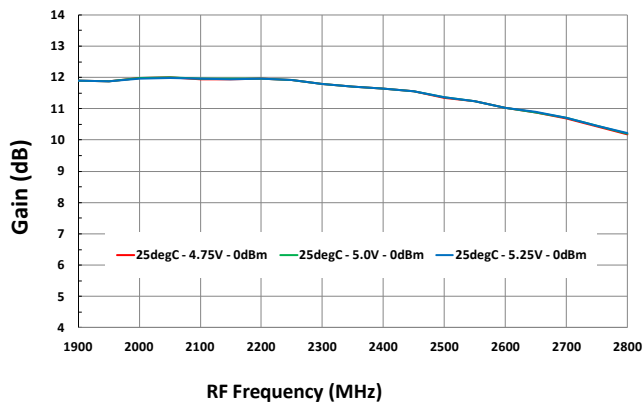

**Output IP3 vs. T<sub>CASE</sub>**

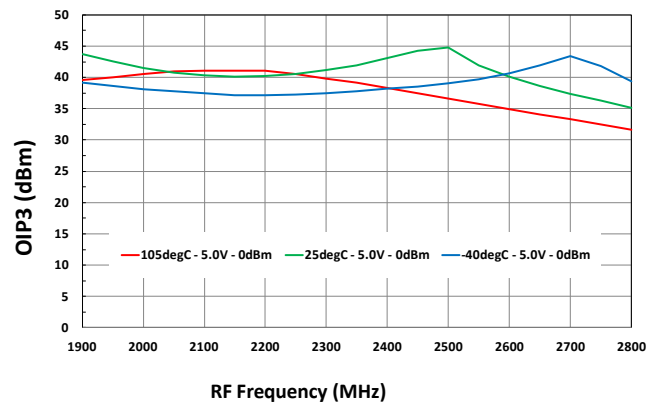

**Output IP3 vs. Lo Level**

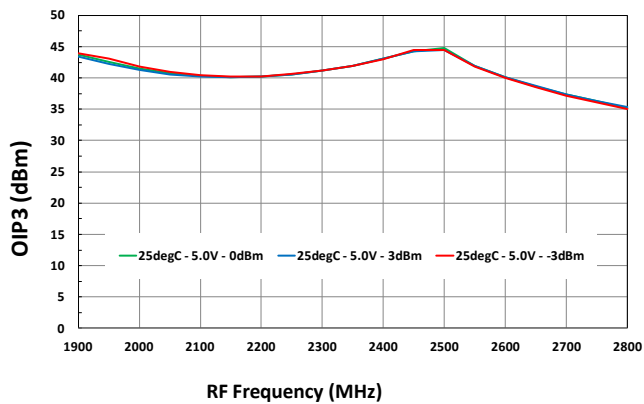

**Output IP3 vs. Vcc**

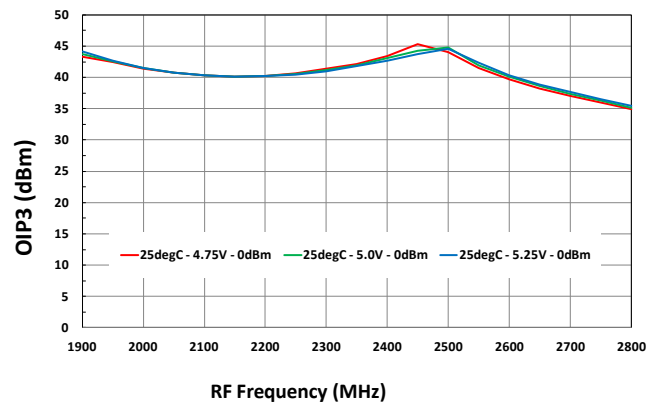



**TOCs [IF = 200MHz, HIGH SIDE INJECTION] P1dB<sub>o</sub>, 2x2 (2)**

**P1dB<sub>o</sub> vs. T<sub>CASE</sub>**

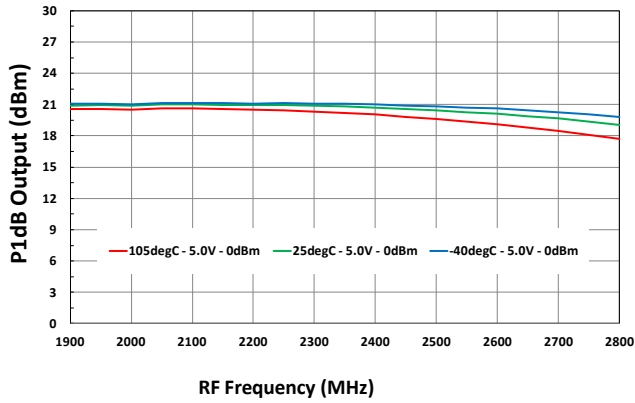

**P1dB<sub>o</sub> vs. Lo Level**

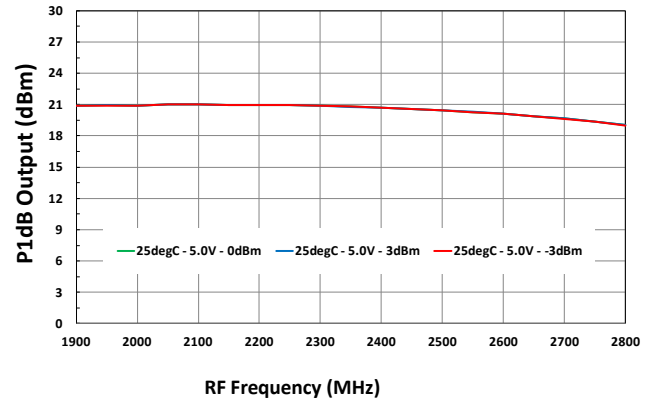

**P1dB<sub>o</sub> vs. V<sub>CC</sub>**

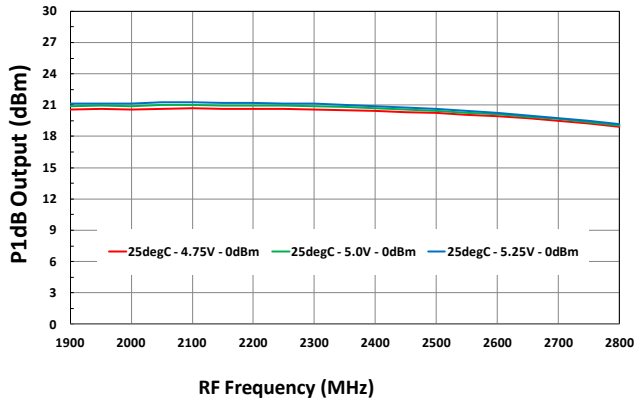

**2x2 Rejection vs. T<sub>CASE</sub>**

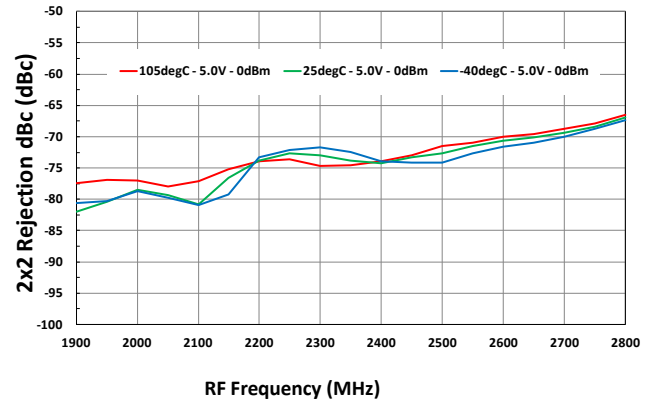

**2x2 Rejection vs. Lo Level**

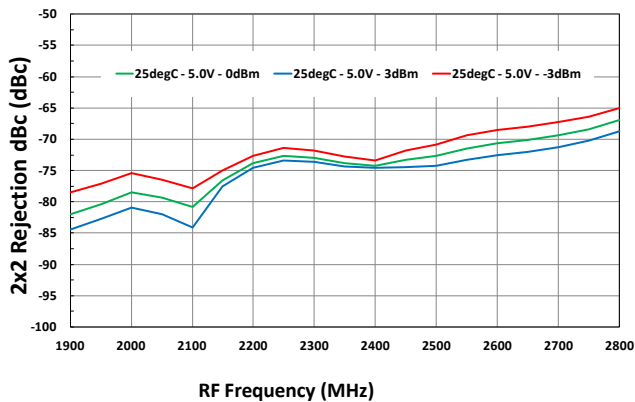

**2x2 Rejection vs. V<sub>CC</sub>**

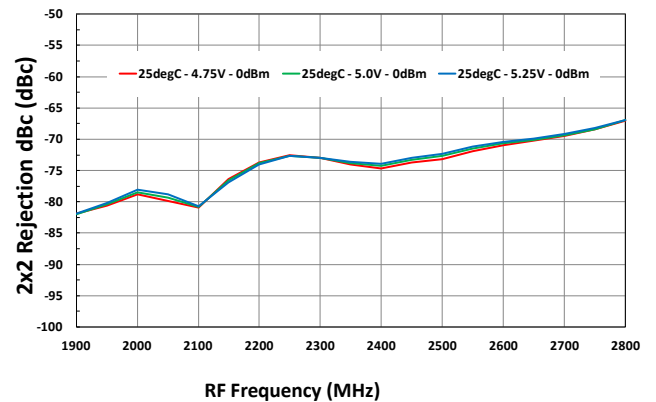



**TOCs [IF = 200MHz, HIGH SIDE INJECTION] 3x3, H2 Rejection (3)**

**3x3 Rejection vs. T<sub>CASE</sub>**

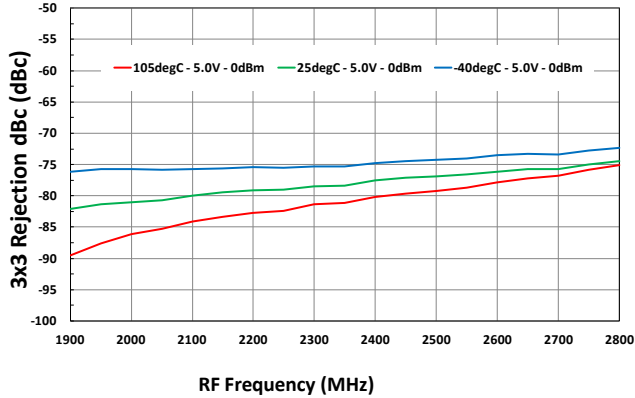

**3x3 Rejection vs. Lo Level**

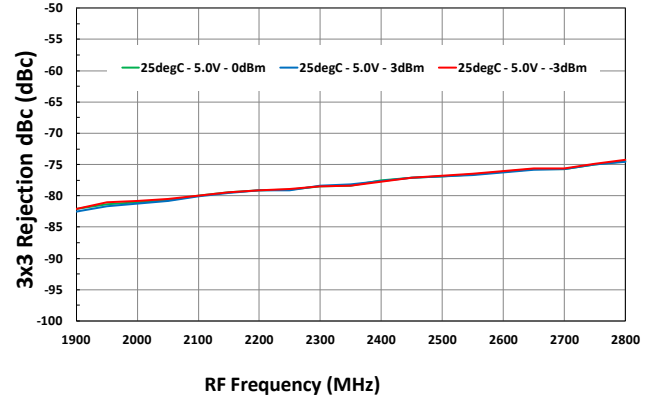

**3x3 Rejection vs. V<sub>CC</sub>**

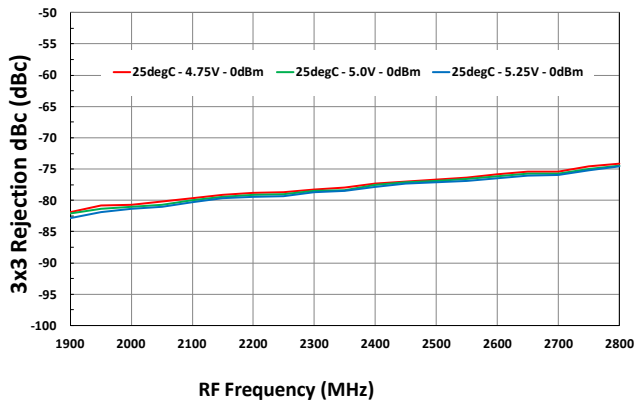

**H2 Rejection vs. T<sub>CASE</sub>**

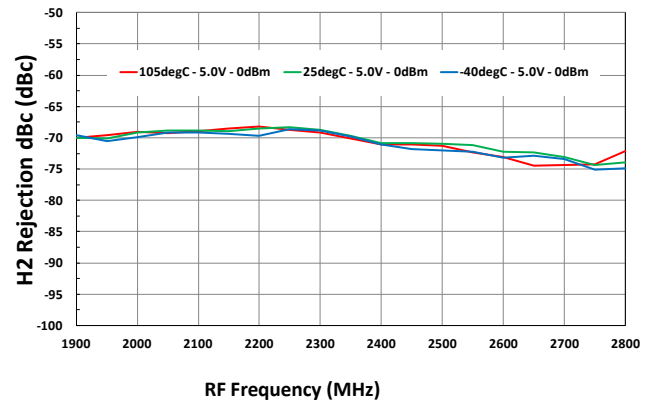

**H2 Rejection vs. Lo Level**

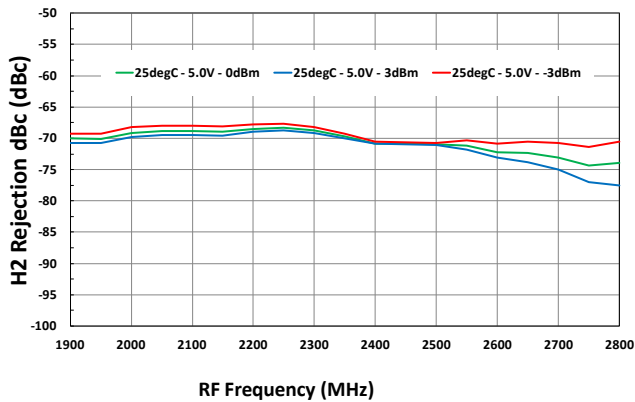

**H2 Rejection vs. V<sub>CC</sub>**

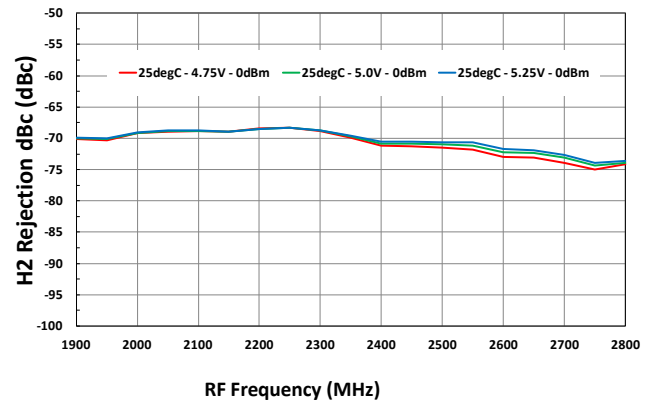



RF to IF Single Downconverting Mixer

2000MHz to 2900MHz

TOCs [IF = 200MHz, HIGH SIDE INJECTION] Icc, LO-IF leakage [4]

**Icc vs. T<sub>CASE</sub>**

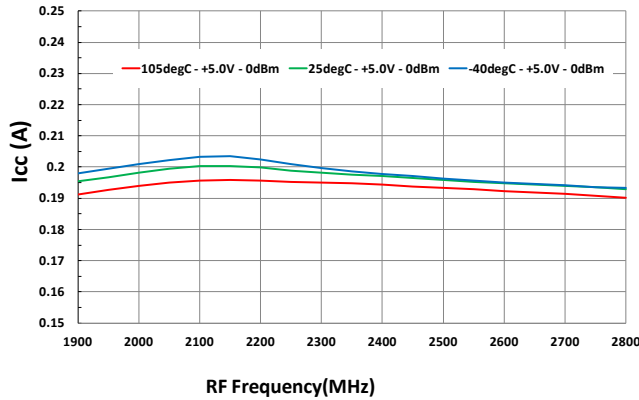

**Icc vs. Lo Level**

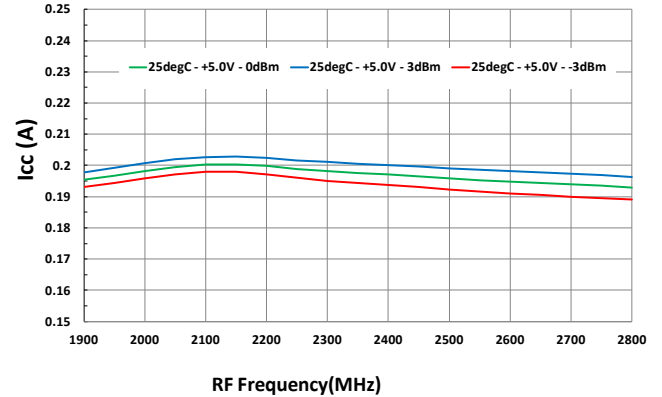

**Icc vs. Vcc**

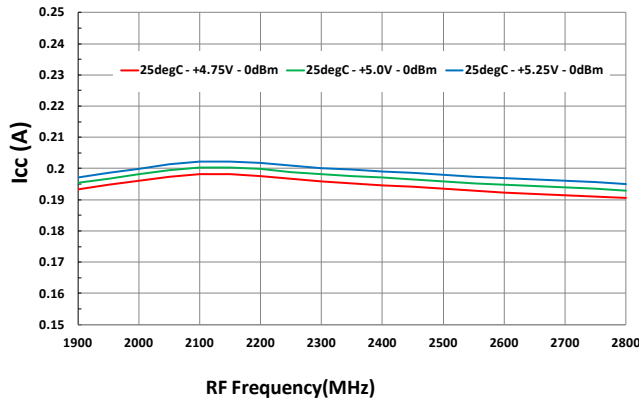

**Lo to IF leakage vs. T<sub>CASE</sub>**

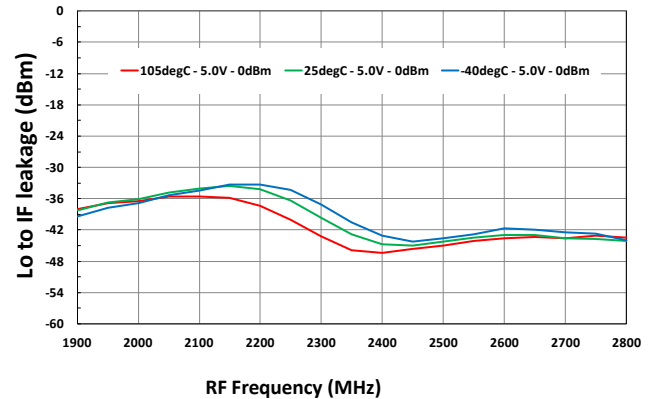

**Lo to IF leakage vs. Lo Level**

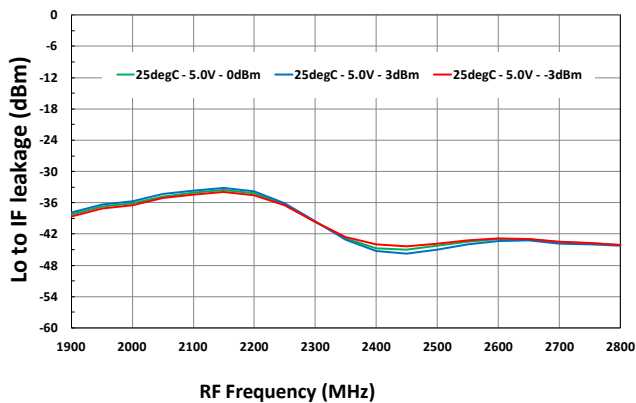

**Lo to IF leakage vs. Vcc**

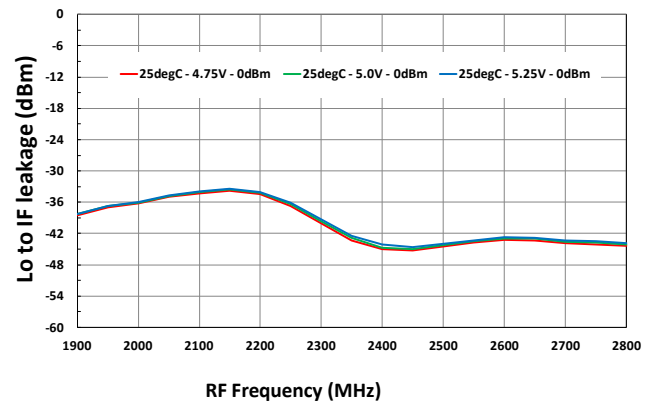

## RF to IF Single Downconverting Mixer

2000MHz to 2900MHz

### TOCs [IF = 200MHz, HIGH SIDE INJECTION] RF to IF leakage, OIP3, HD2 (5)

RF to IF leakage vs.  $T_{CASE}$

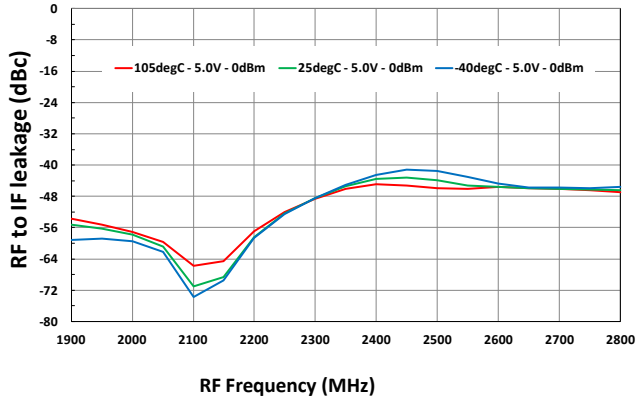

RF to IF leakage vs.  $Lo$  Level

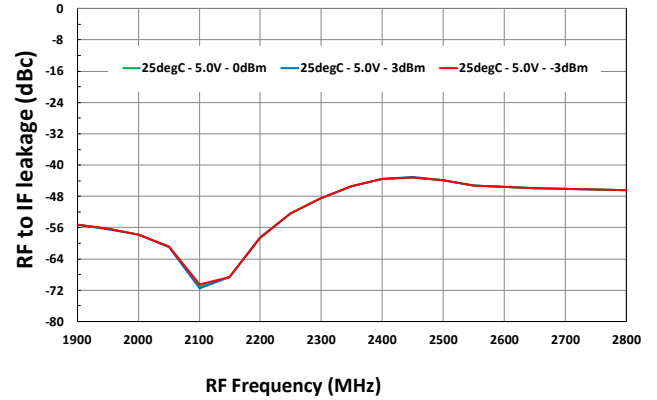

RF to IF leakage vs.  $V_{CC}$

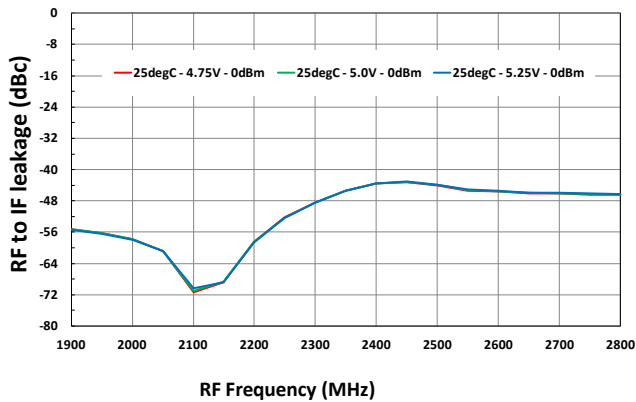

OIP3 vs. Input power

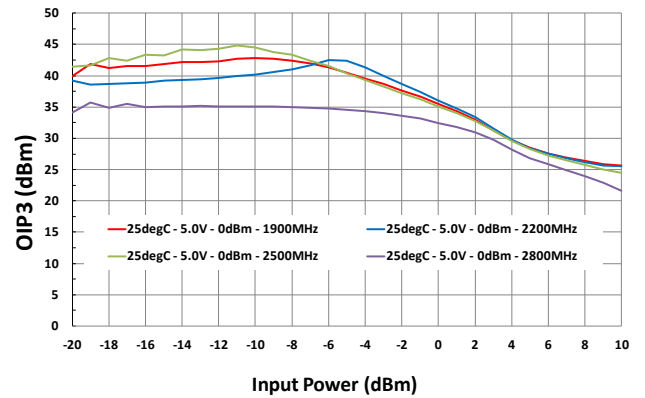

HD2 vs. Input power

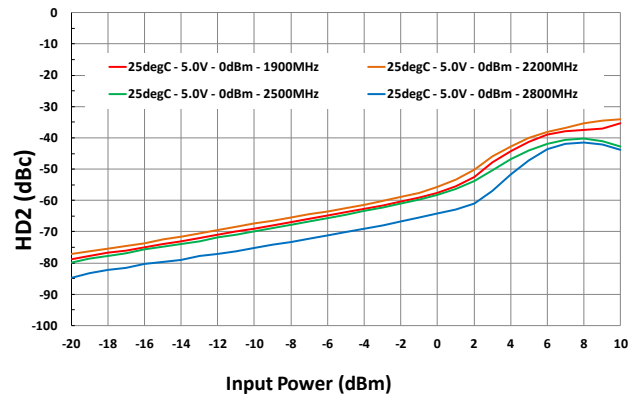

OIP3 vs. Delta Frequency of two tones

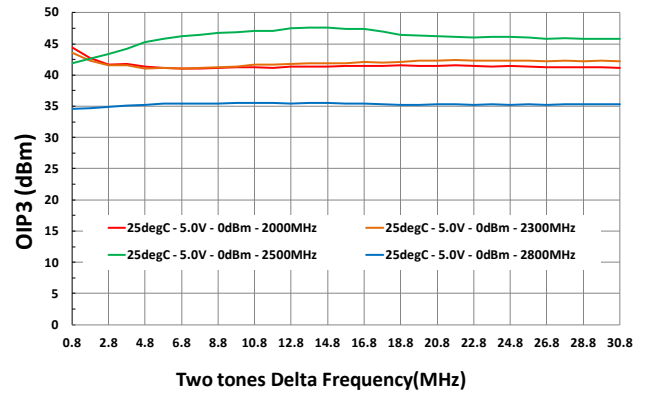

### TOCs [IF = 200MHz, LOW SIDE INJECTION] Gain, OIP3 (6)

Gain vs. T<sub>CASE</sub>

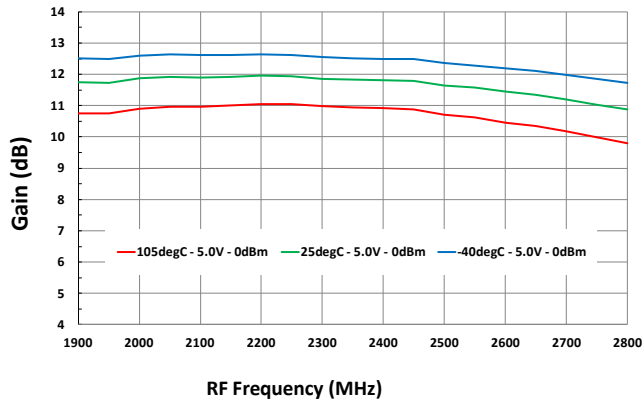

Gain vs. Lo Level

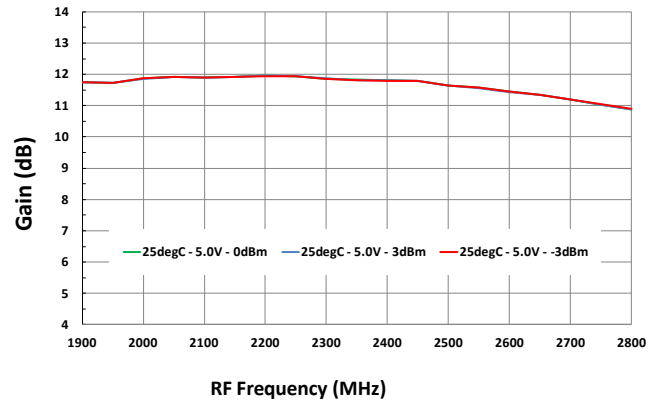

Gain vs. V<sub>CC</sub>

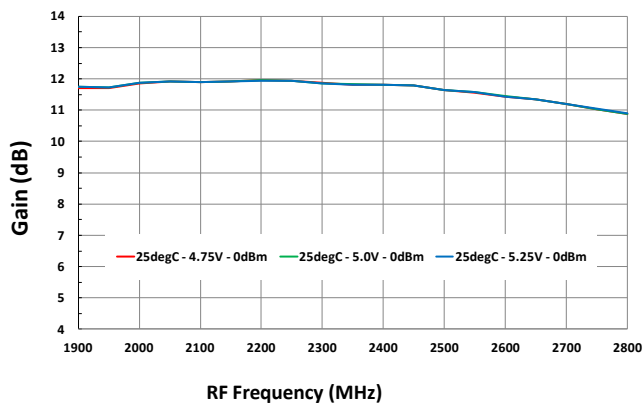

Output IP3 vs. T<sub>CASE</sub>

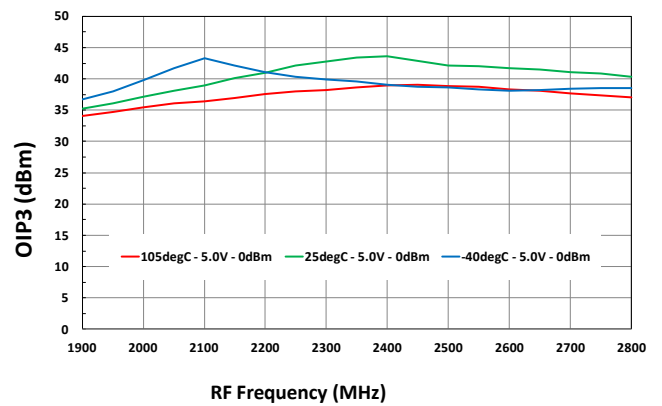

Output IP3 vs. Lo Level

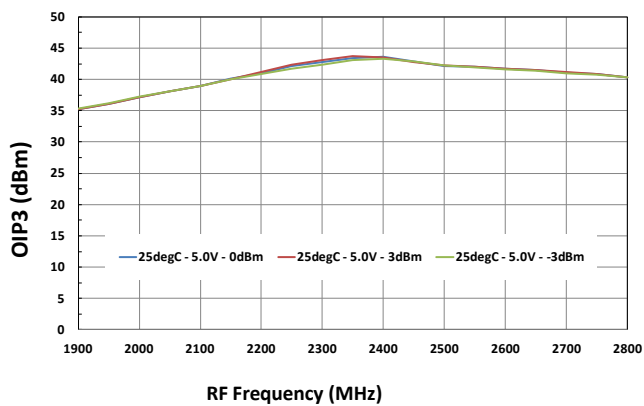

Output IP3 vs. V<sub>CC</sub>

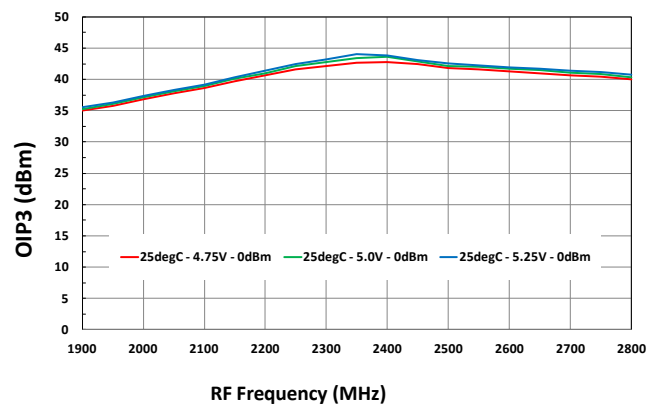



RF to IF Single Downconverting Mixer

2000MHz to 2900MHz

**TOCs [IF = 200MHz, LOW SIDE INJECTION] P1dB<sub>o</sub>, 2x2 (7)**

**P1dB<sub>o</sub> vs. T<sub>CASE</sub>**

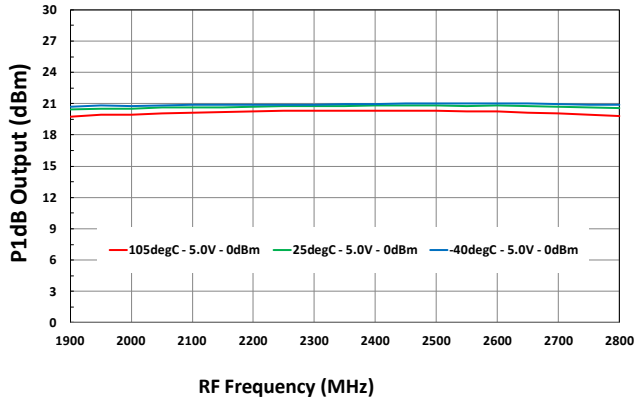

**P1dB<sub>o</sub> vs. Lo Level**

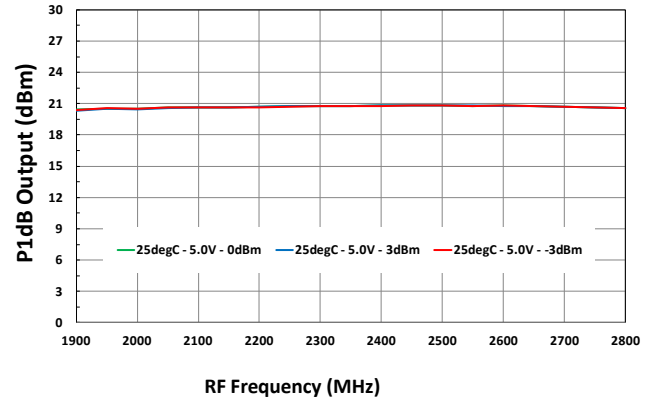

**P1dB<sub>o</sub> vs. V<sub>CC</sub>**

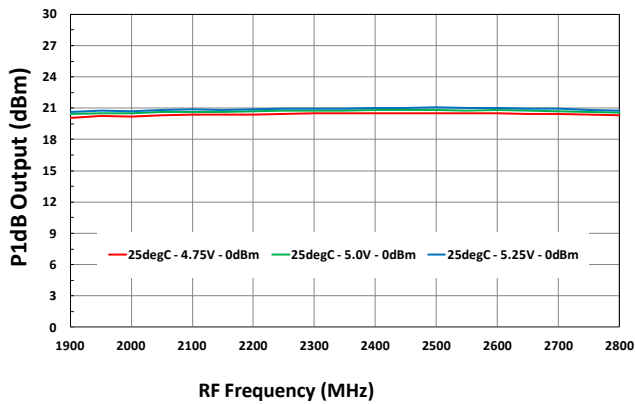

**2x2 Rejection vs. T<sub>CASE</sub>**

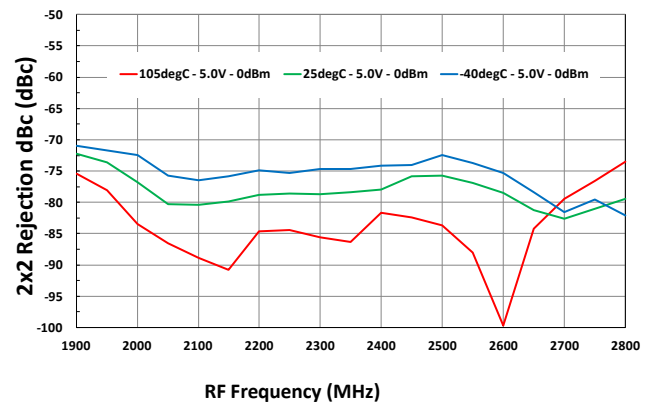

**2x2 Rejection vs. Lo Level**

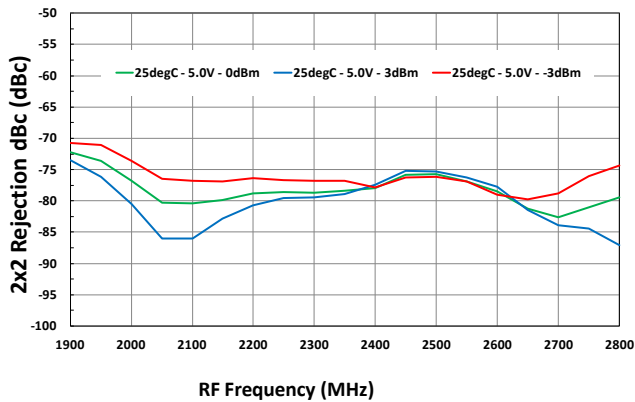

**2x2 Rejection vs. V<sub>CC</sub>**

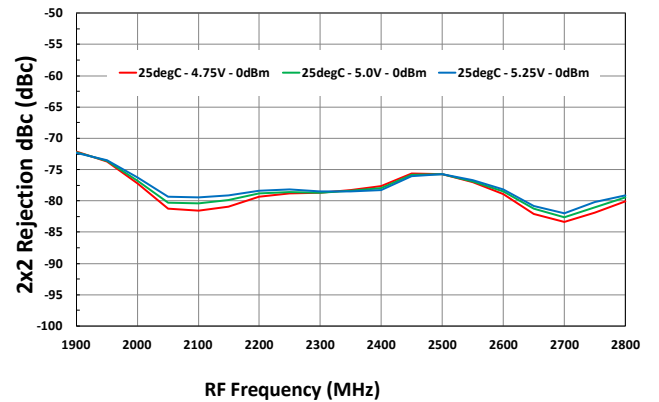

**TOCs [IF = 200MHz, LOW SIDE INJECTION] 3x3, H2 Rejection (8)**

**3x3 Rejection vs. T<sub>CASE</sub>**

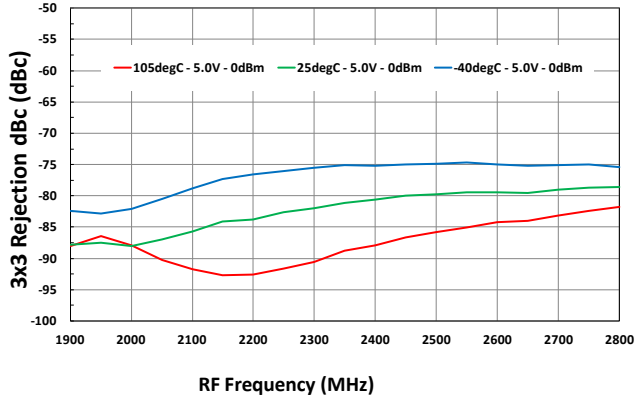

**3x3 Rejection vs. Lo Level**

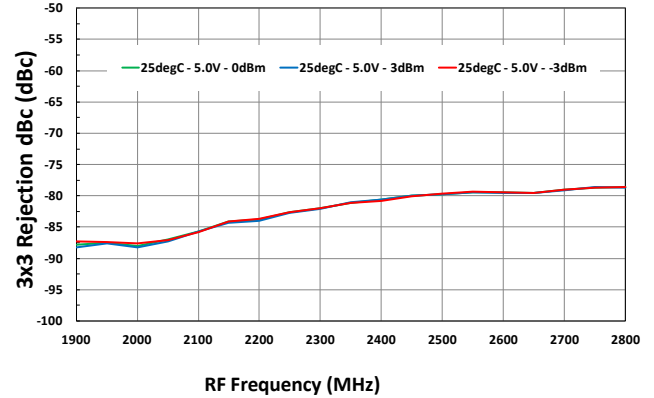

**3x3 Rejection vs. Vcc**

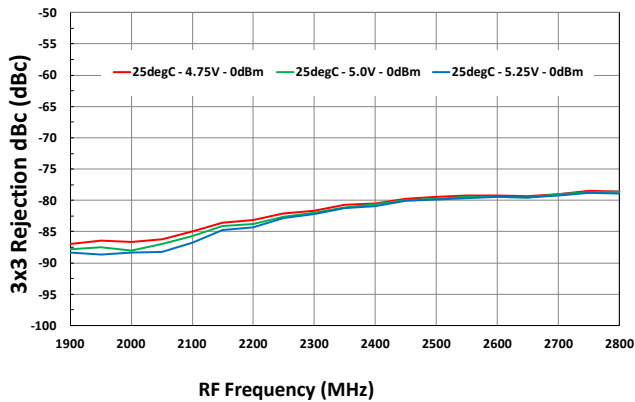

**H2 Rejection vs. T<sub>CASE</sub>**

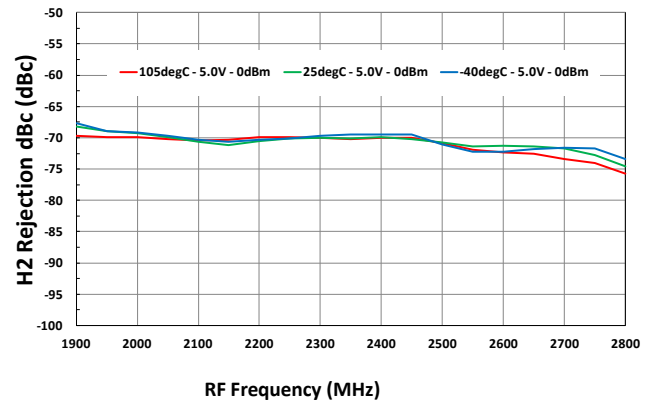

**H2 Rejection vs. Lo Level**

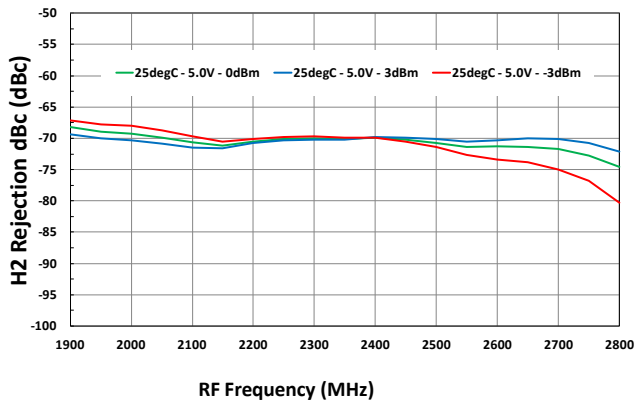

**H2 Rejection vs. Vcc**

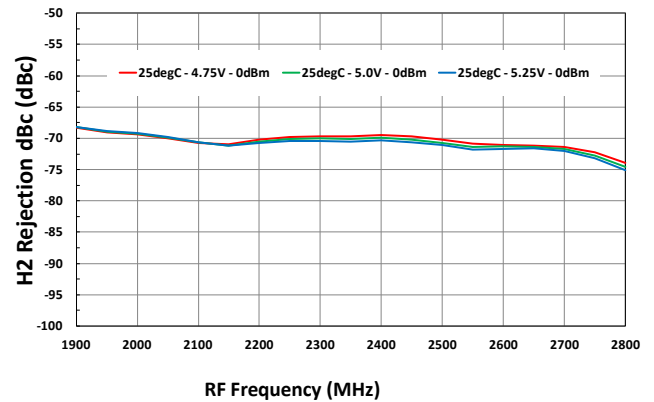



RF to IF Single Downconverting Mixer

2000MHz to 2900MHz

## TOCs [IF = 200MHz, LOW SIDE INJECTION] Icc, Lo to IF Leakage (9)

### Icc vs. T<sub>CASE</sub>

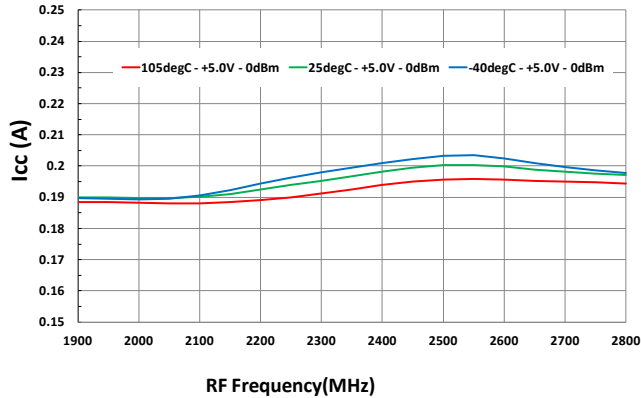

### Icc vs. Lo Level

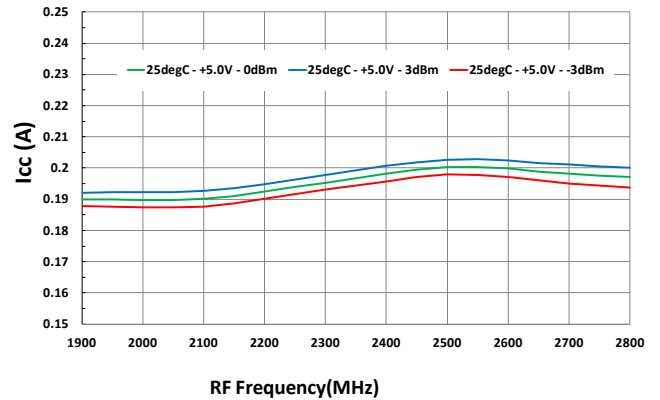

### Icc vs. Vcc

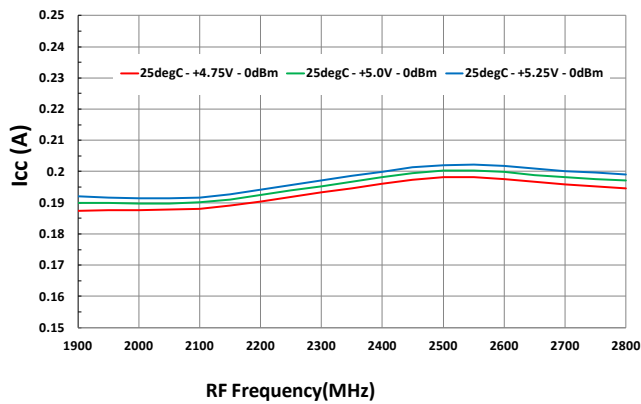

### Lo to IF leakage vs. T<sub>CASE</sub>

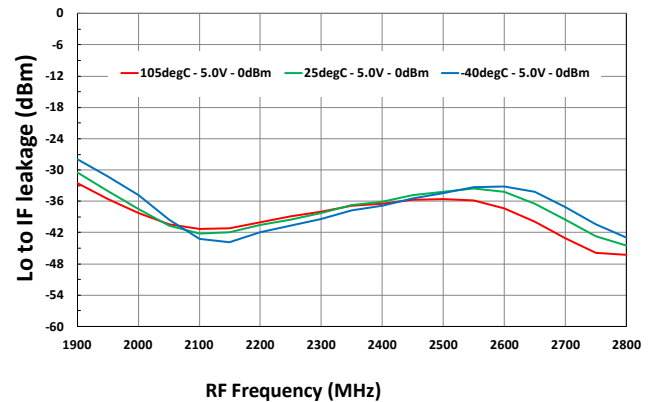

### Lo to IF leakage vs. Lo Level

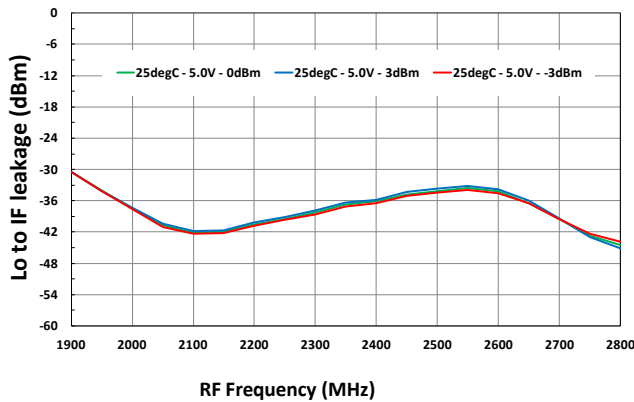

### Lo to IF leakage vs. Vcc

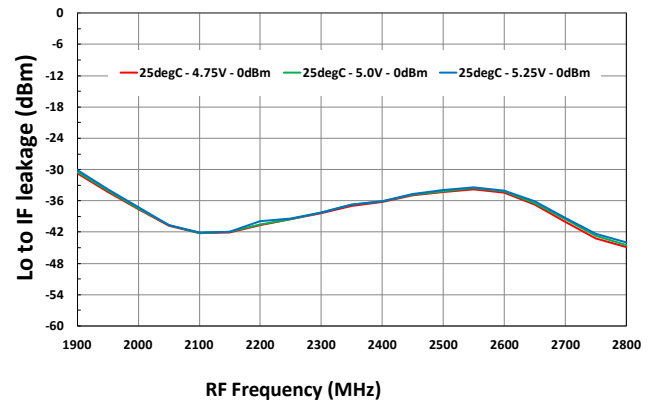

## TOCs [IF = 200MHz, Low Side Injection] RF to IF leakage, OIP3, H2 (10)

RF to IF leakage vs. TCASE

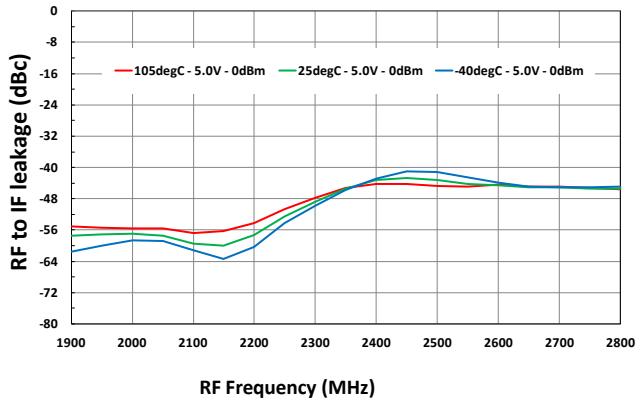

RF to IF leakage vs. Lo Level

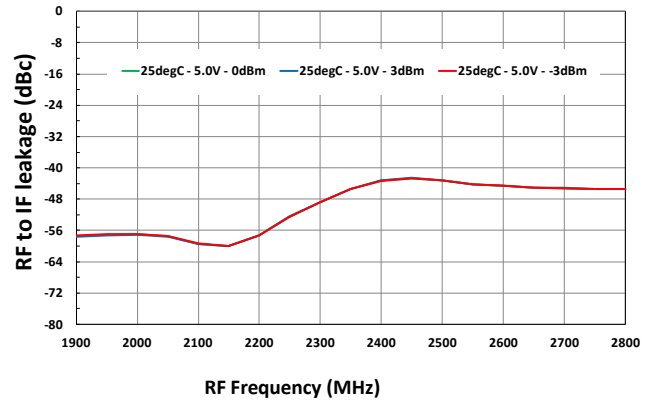

RF to IF leakage vs. Vcc

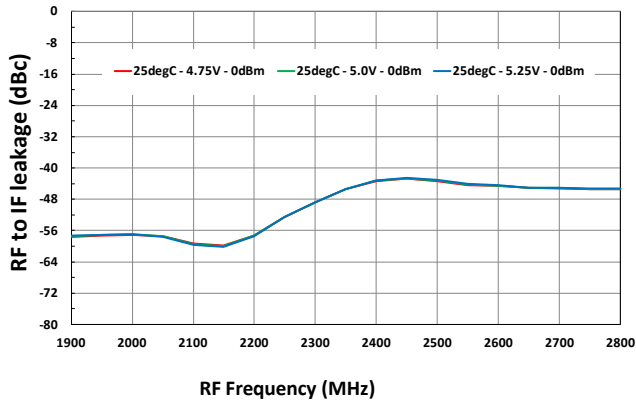

OIP3 vs. Input power

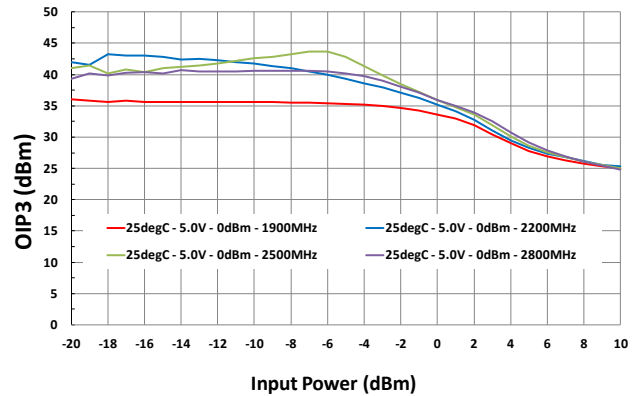

HD2 vs. Input power

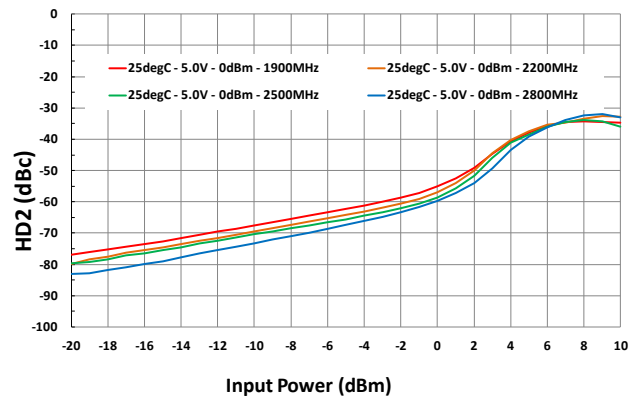

OIP3 vs. Delta Frequency of two tones

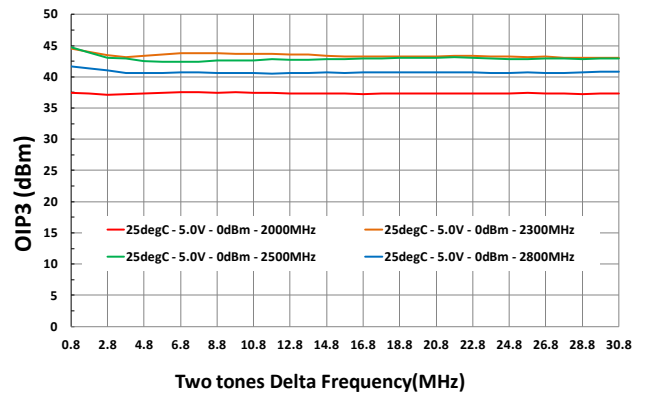



## RF to IF Single Downconverting Mixer

2000MHz to 2900MHz

### TOCs NF, Settling Time, Return Loss (11)

#### Noise Figure vs. T<sub>CASE</sub>

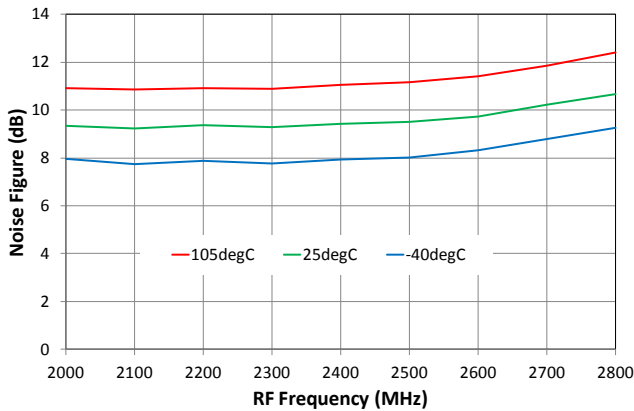

#### Noise Figure with Blocker (RF: 2500MHz, Blocker: 2600MHz)

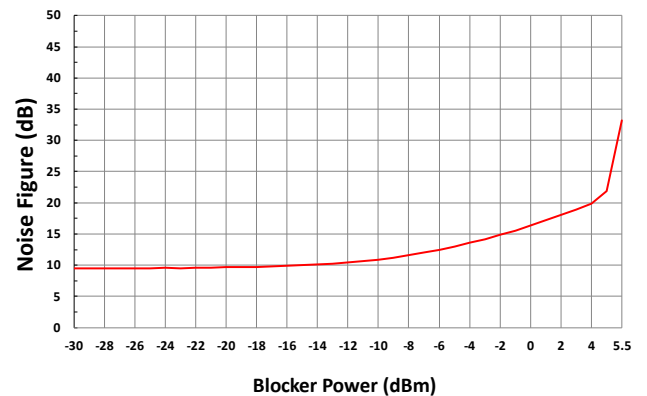

#### Turn on Settling

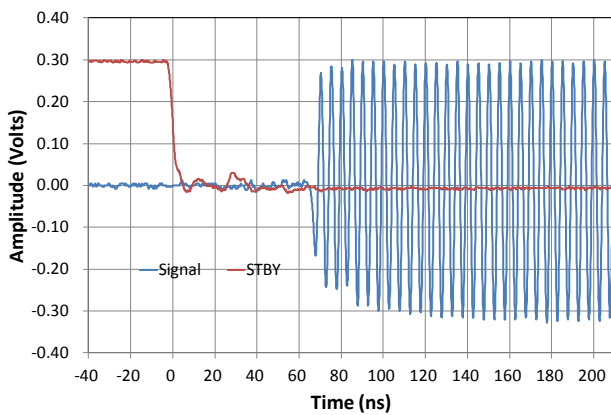

#### Turn off Settling

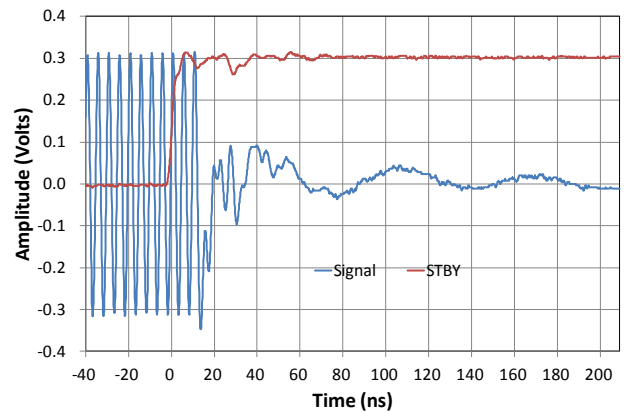

#### Lo port Return Loss

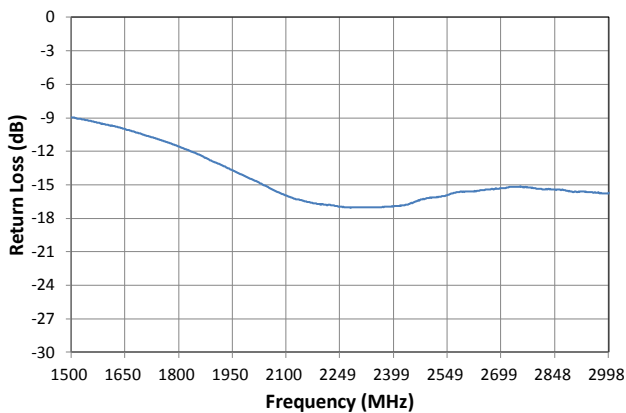

#### RF port Return Loss

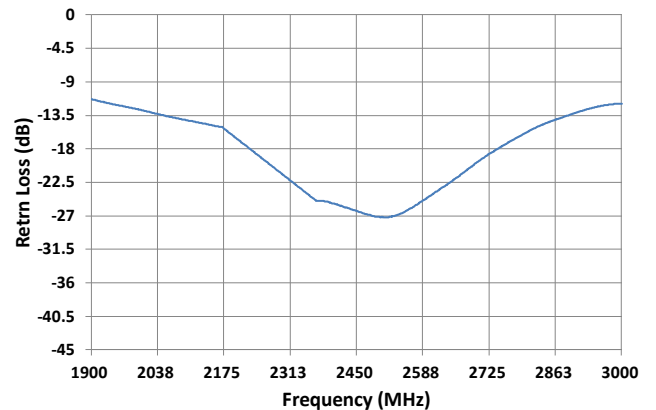



RF to IF Single Downconverting Mixer

200MHz to 2900MHz

### TOCs Return Loss (12)

#### IF port Return Loss

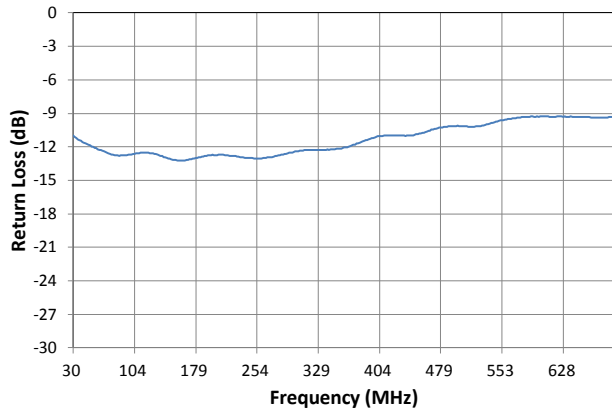



# IDTF1763NBGI Datasheet

RF to IF Single Downconverting Mixer

1900MHz to 2900MHz

## PACKAGE DRAWING (NBG20)

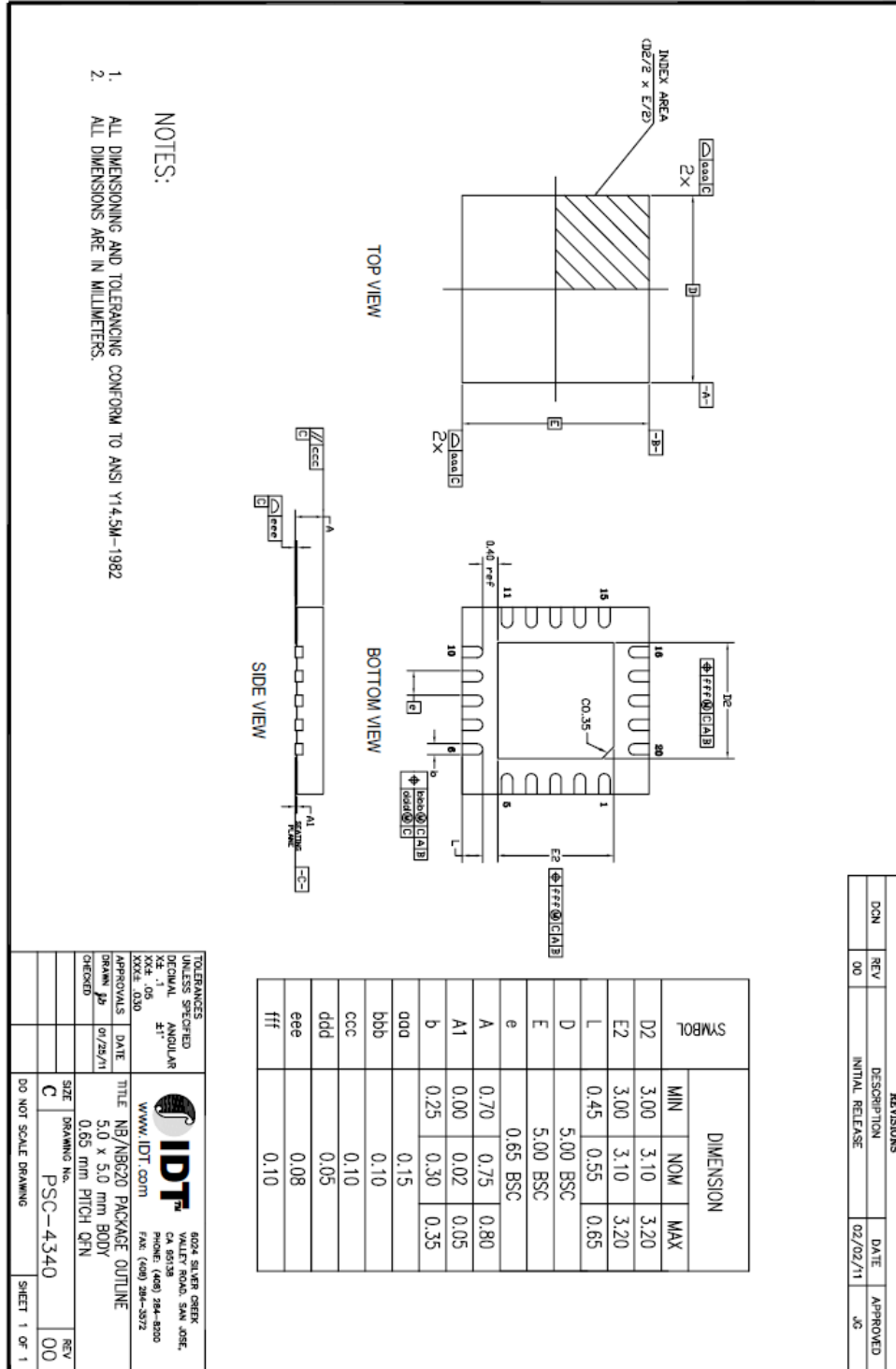

**PIN DIAGRAM**

**BLACK TEXT** is recommended external connection  
**RED TEXT** denotes internal function or connection

**TOP View**

*(looking through the top of the package)*

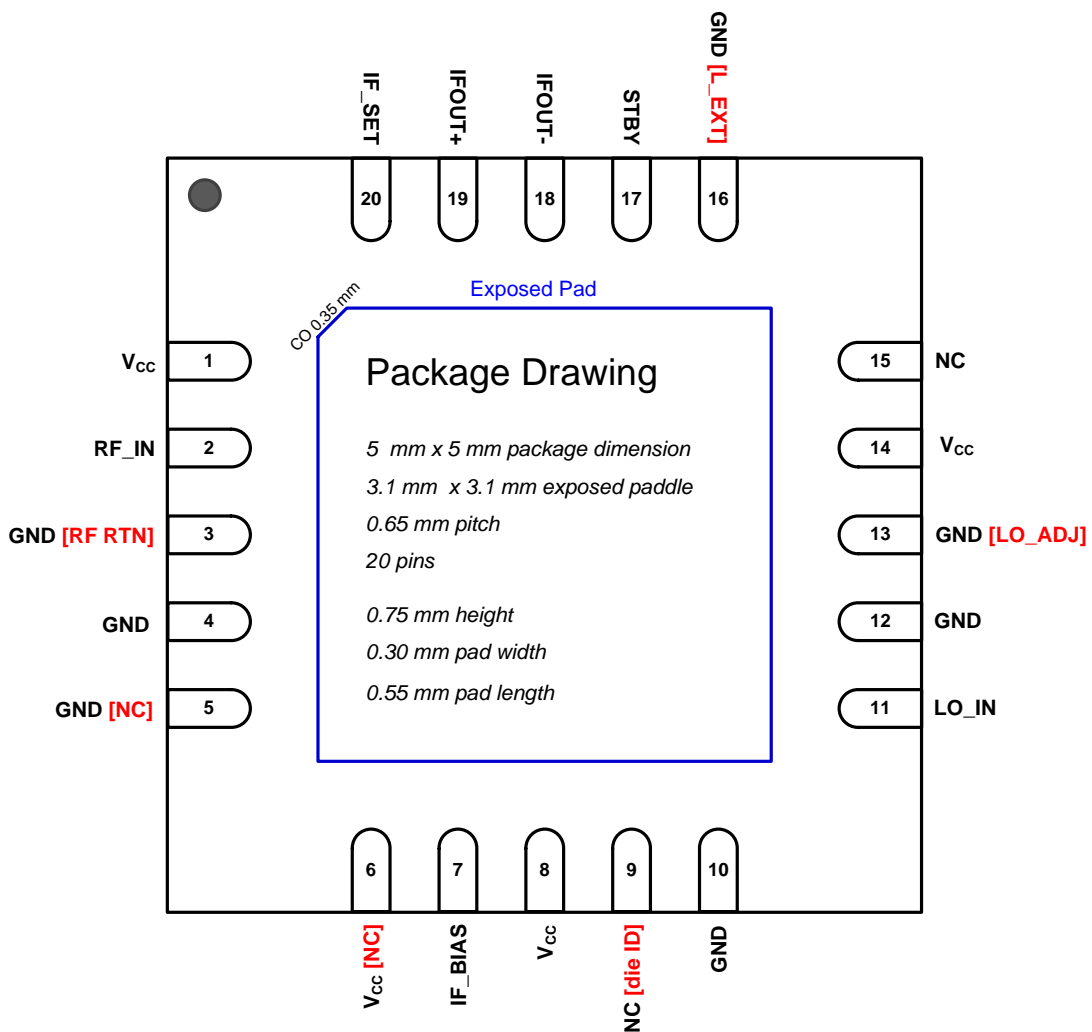

**PIN DESCRIPTIONS**

| Pin | Name         | Function   |
|-----|--------------|--|
| 1   | VCC          | Power Supply. Bypass to GND with capacitors shown in the Typical Application Circuit as close as possible to pin.  |
| 2   | RF_IN        | RF Input. Internally matched to 50Ω. Do not apply DC to this pin.  |
| 3   | GND [RF_RTN] | RF input Balun return. Ground this pin   |
| 4   | GND          | Internally bonded to GND   |
| 5   | GND [NC]     | No Connection. Not internally connected. OK to connect to VCC. OK to connect to GND.   |
| 6   | VCC [NC]     | No Connection. Not internally connected. OK to connect to VCC. OK to connect to GND.   |
| 7   | IF_BIAS      | Connect the specified resistor from this pin to ground to optimize linearity.  |
| 8   | VCC          | Power Supply. Bypass to GND with capacitors shown in the Typical Application Circuit as close as possible to pin.  |
| 9   | NC [die ID]  | This pin serves as the die ID. Leave it unconnected  |
| 10  | GND          | Internally bonded to GND   |
| 11  | LO_IN        | Local Oscillator Input. This input is internally matched to 50Ω. This pin requires an input DC-blocking capacitor  |
| 12  | GND          | Internally bonded to GND   |
| 13  | GND [LO_ADJ] | Ground this pin for best linearity performance. A resistor from this pin to GND can be used to reduce DC power consumption while slightly degrading linearity performance. |
| 14  | VCC          | Power Supply. Bypass to GND with capacitors shown in the Typical Application Circuit as close as possible to pin.  |
| 15  | NC           | No Connection. Not internally connected. OK to connect to VCC. OK to connect to GND.   |
| 16  | GND [L_EXT]  | Provisions for an external inductor. Ground this pin for normal operation.   |
| 17  | STBY         | Ground for normal operation. Pull high to disable  |
| 18  | IF_OUT-      | Mixer Differential IF Output. Connect pullup inductor from this pin to VCC (see the Typical Application Circuit).  |
| 19  | IF_OUT+      | Mixer Differential IF Output. Connect pullup inductor from this pin to VCC (see the Typical Application Circuit).  |
| 20  | IF_SET       | Connect the specified resistor from this pin to ground to set the correct Icc for the IF amplifier.  |
|     | — EP         | Exposed Pad. Internally connected to GND. Connect to Ground with multiple vias for good thermal relief   |

### EVKIT / APPLICATION CIRCUIT

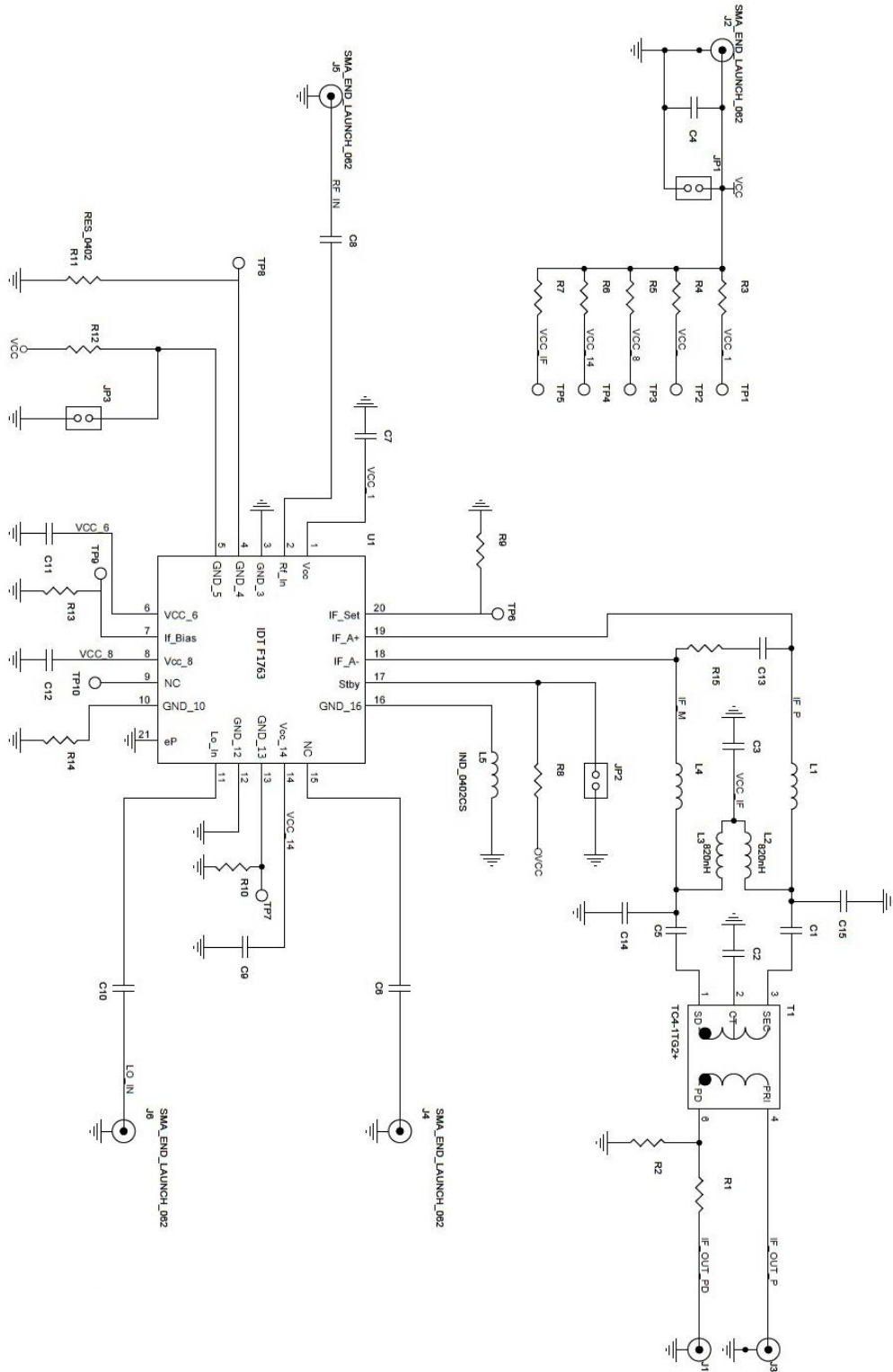

## POWER SUPPLIES

All supply pins should be bypassed with external capacitors to minimize noise and fast transients. Supply noise can degrade noise figure and fast transients can trigger ESD clamps and cause them to fail. Supply voltage change or transients should have a slew rate smaller than 1V/20uS. In addition, all control pins should remain at 0V (+/-0.3V) while the supply voltage ramps or while it returns to zero.

## EVKIT PICTURE/LAYOUT/OPERATION

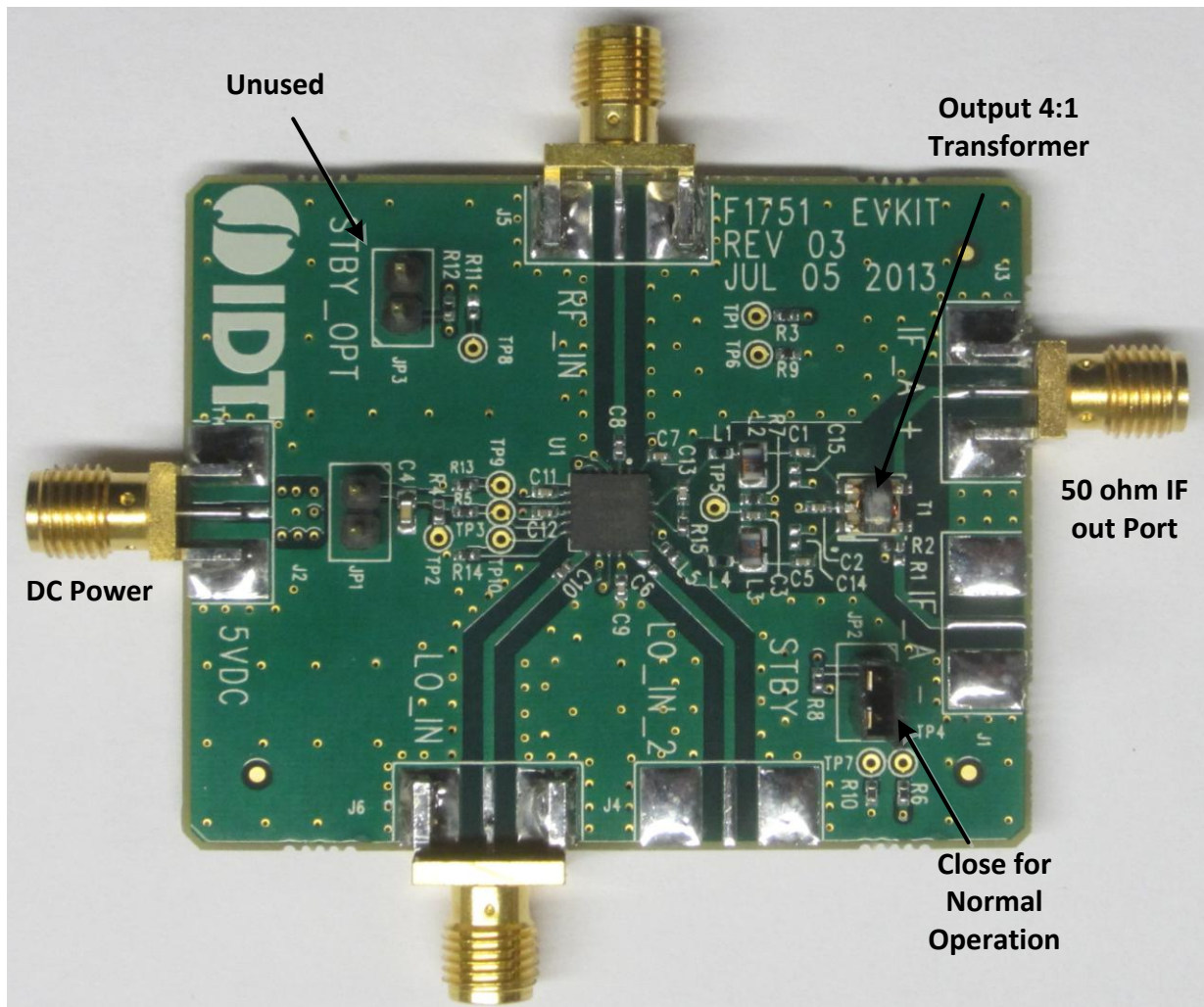

### EVKIT BOM

F1763  
11/26/2013

| Item # | Value          | Size/Rev | Desc                                    | Mfr. Part #         | Mfr.            | Supplier Part #  | Supplier      | Part Reference           | Qty |
|--------|----------------|----------|---|---------------------|-----------------|------------------|---------------|--------------------------|-----|
| 1      | 10nF           | 0402     | CAP CER 10000PF 16V 10% X7R 0402        | GRM155R71C103KA01D  | MURATA          | 490-1313-1-ND    | Digikey       | C1,2,3,5,7,9,12          | 7   |
| 2      | 10uF           | 0603     | CAP CER 10UF 6.3V X5R 0603              | GRM188R60J106ME47D  | MURATA          | 490-3896-1-ND    | Digikey       | C4                       | 1   |
| 3      | 0.5pF          | 0402     | CAP CER 0.5PF 50V NPO 0402              | GJM1555C1HR50BB01D  | MURATA          | 490-6077-1-ND    | Digikey       | C13                      | 1   |
| 4      | 39pF           | 0402     | CAP CER 39PF 50V 5% COG 0402            | GRM1555C1H390JZ010  | MURATA          | 490-1286-1-ND    | Digikey       | C8,10                    | 2   |
| 5      | 0              | 0402     | RES 0.0 OHM 1/10W 0402 SMD              | ERJ-2GE0R00X        | Panasonic       | P0.0JCT-ND       | Digikey       | R2,3,4,5,6,7,10,11,14,L5 | 10  |
| 6      | 100            | 0402     | RES 100 OHM 1/10W 1% 0402 SMD           | ERJ-2RKF1000X       | Panasonic       | P100LCT-ND       | Digikey       | R15                      | 1   |
| 7      | 1K             | 0402     | RES 1K OHM 1/10 1% 0402 SMD             | ERJ-2RKF1001X       | Panasonic       | P1.00KLCT-ND     | Digikey       | R9                       | 1   |
| 8      | 12.1K          | 0402     | RES 12.1K OHM 1/10 1% 0402 SMD          | ERJ-2RKF1212X       | Panasonic       | P12.1KLCT-ND     | Digikey       | R13                      | 1   |
| 9      | 47K            | 0402     | RES 47.0K OHM 1/16W 1% 0402 SMD         | RC0402FR-0747KL     | Yageo           | 311-47.0KLRCT-ND | Digikey       | R8                       | 1   |
| 10     | 22nH           | 0402     | 0402 Inductor 22nH LQW series           | LQW15AN22NJ00D      | MURATA          | 490-1150-1-ND    | Digikey       | L1,4                     | 2   |
| 11     | 820nH          | 0805     | 0805CS (2012) Ceramic Chip Inductor     | 0805CS-821XJLB      | COILCRAFT       | 0805CS-821XJLB   | COILCRAFT     | L2,3                     | 2   |
| 12     | Header_2Pin    | TH_2     | CONN HEADER VERT SGL 2POS GOLD          | 961102-6404-AR      | 3M              | 3M9447-ND        | Digikey       | JP1,2                    | 2   |
| 13     | SMA_END_LAUNCH | .062     | CONN SMA JACK END LAUNCH PCB (Big)      | 142-0701-851        | Emerson Johnson | 530-142-0701-851 | Mouser        | J5,6                     | 2   |
| 14     | SMA_END_LAUNCH | .062     | CONN SMA JACK END LAUNCH PCB (Small)    | 142-0711-821        | Emerson Johnson | 530-142-0711-821 | Mouser        | J2,3                     | 2   |
| 15     | 4:1 Balun      | SM-22    | 4:1 Center Tap Balun 50 OHM 3 TO 800Mhz | TC4-6TG2+           | Mini Circuits   | TC4-6TG2+        | Mini Circuits | T1                       | 1   |
| 16     | F1763          | QFN-20   | RF MIXER                                | F1763               | IDT             | F1763_013        | IDT           | U1                       | 1   |
| 17     | PCB            | 02       | Printed Circuit Board                   | F1751 EV Kit Rev 03 |                 |                  |               |                          | 1   |
| 18     | BOM            | 03       | Bill Of Material                        |                     |                 |                  |               |                          |     |
| 19     | DNP            | 402      |   |                     |                 |                  |               | R1,12,C6,11,14,15,JP3    |     |
| Total  |                |          |   |                     |                 |                  |               |                          | 38  |

### TOP MARKINGS

