

MLX90372 - Triaxis® Position Processor

Datasheet

Features and Benefits

- **Triaxis®** Hall Technology
- On Chip Signal Processing for Robust Absolute Position Sensing
- **ASIL READY** BY MELEXIS ISO26262 ASIL-C Safety Element out of Context
- AEC-Q100 Qualified
- Programmable Measurement Range
- Programmable Linear Transfer Characteristic (4 or 8 Multi-points or 16 or 32 PWL)
- Selectable (fast) SENT or PWM Output
- SAE J2716 APR2016 SENT
- Enhanced serial data communication
- 48 bits ID Number option
- Single Die - SOIC-8 Package (RoHS)
- Dual Die (Full Redundant) - TSSOP-16 Package (RoHS)
- PCB-less DMP-4 Package (RoHS)
- Robustness against stray-field



SOIC-8

TSSOP-16

DMP-4

Application Examples

- Absolute Rotary Position Sensor
- Pedal Position Sensor
- Throttle Position Sensor
- Ride Height Position Sensor
- Absolute Linear Position Sensor
- Steering Wheel Position Sensor
- Float-Level Sensor
- Non-Contacting Potentiometer

Description

The MLX90372 is a monolithic magnetic position processor IC. It consists of a Triaxis® Hall magnetic front end, an analog to digital signal conditioner, a DSP for advanced signal processing and an output stage driver.

The MLX90372 is sensitive to the three components of the magnetic flux density applied to the IC (i.e. B_x , B_y and B_z). This allows the MLX90372 with the correct magnetic circuit to decode the absolute position of any moving magnet (e.g. rotary position from 0 to 360 Degrees or linear displacement, see fig. 2). It enables the design of non-contacting position sensors that are frequently required for both automotive and industrial applications.

The MLX90372 provides SENT frames encoded according to a Secure Sensor format. The circuit delivers enhanced serial messages providing error codes, and user-defined values. Through programming, the MLX90372 can also be configured to output a PWM (Pulse Width Modulated) signal.



Ordering Information

Product	Temp.	Package	Option Code	Packing Form	Definition
MLX90372	G	DC	ACC-300	RE	Angular Rotary / Linear position
MLX90372	G	GO	ACC-200	RE	Linear position Strayfield Immune
MLX90372	G	GO	ACC-300	RE	Angular Rotary / Linear position
MLX90372	G	VS	ACC-300	RE/RX	Angular Rotary / Linear position
MLX90372	G	VS	ACC-301	RE/RX	Angular Rotary / Linear position
MLX90372	G	VS	ACC-303	RE/RX	Angular Rotary / Linear position
MLX90372	G	VS	ACC-308	RE/RX	Angular Rotary / Linear position
MLX90372	G	DC	ACE-100	RE	Angular Rotary Strayfield Immune
MLX90372	G	DC	ACE-200	RE	Linear position Strayfield Immune
MLX90372	G	DC	ACE-300	RE	Angular Rotary / Linear position
MLX90372	G	GO	ACE-100	RE	Angular Rotary Strayfield Immune
MLX90372	G	GO	ACE-200	RE	Linear position Strayfield Immune
MLX90372	G	GO	ACE-300	RE	Angular Rotary / Linear position
MLX90372	G	GO	ACE-500	RE	Angular Rotary Strayfield Immune
MLX90372	G	VS	ACE-100	RE/RX	Angular Rotary Strayfield Immune
MLX90372	G	VS	ACE-101	RE/RX	Angular Rotary Strayfield Immune
MLX90372	G	VS	ACE-103	RE/RX	Angular Rotary Strayfield Immune
MLX90372	G	VS	ACE-108	RE/RX	Angular Rotary Strayfield Immune
MLX90372	G	VS	ACE-200	RE/RX	Angular Rotary / Linear position
MLX90372	G	VS	ACE-201	RE/RX	Angular Rotary / Linear position
MLX90372	G	VS	ACE-203	RE/RX	Angular Rotary / Linear position
MLX90372	G	VS	ACE-208	RE/RX	Angular Rotary / Linear position
MLX90372	G	VS	ACE-300	RE/RX	Angular Rotary / Linear position
MLX90372	G	VS	ACE-301	RE/RX	Angular Rotary / Linear position
MLX90372	G	VS	ACE-303	RE/RX	Angular Rotary / Linear position
MLX90372	G	VS	ACE-308	RE/RX	Angular Rotary / Linear position
MLX90372	G	VS	ACE-350	RE/RX	Angular Rotary / Linear position
MLX90372	G	VS	ACE-357	RE/RX	Angular Rotary / Linear position
MLX90372	G	VS	ADE-310	RE/RX	Angular Rotary / Linear position
MLX90372	G	VS	ADE-311	RE/RX	Angular Rotary / Linear position
MLX90372	G	VS	ADE-313	RE/RX	Angular Rotary / Linear position
MLX90372	G	VS	ADE-318	RE/RX	Angular Rotary / Linear position

Table 1 - Ordering Codes

Temperature Code:	G: from -40°C to 160°C
Package Code:	DC : SOIC-8 package (see 18.1) GO : TSSOP-16 package (full redundancy dual die, see 18.5) VS : DMP-4 package (PCB-less dual mold, see 18.12)
Option Code - Chip revision	ACE-123 : Chip Revision <ul style="list-style-type: none"> ▪ ACC : Not recommended for new designs ⁽¹⁾ ▪ ACE : Standard preferred revision ⁽¹⁾ ▪ ADE : DMP “low emissions” version
Option Code - Application	ACE-123 : 1-Application - Magnetic configuration <ul style="list-style-type: none"> ▪ 1: Angular Rotary Strayfield Immune - Low field Variant ▪ 2: Linear position Strayfield Immune ▪ 3: Legacy / Angular Rotary / Linear position ▪ 5: Angular Rotary Strayfield Immune - High field Variant
Option Code - SW & DMP-4 configuration	ACE-123 : 2-SW and DMP-4 package configuration For SOIC-8 (code DC) and TSSOP-16 (code GO) packages <ul style="list-style-type: none"> ▪ 0: SENT 3μs mode For DMP-4 (code VS) package with Pinout-A (see section 3.3) <ul style="list-style-type: none"> ▪ 0: SENT 3μs mode, standard capacitor configuration ⁽²⁾ ▪ 1: SENT 3μs mode, capacitor configuration no 2 ⁽²⁾ For DMP-4 (code VS) package with Pinout-B (see section 3.4) <ul style="list-style-type: none"> ▪ 5: SENT 3μs mode
Option Code - Trim & Form	ACE-123 : 3-DMP-4 Trim & Form configuration <ul style="list-style-type: none"> ▪ 0: Standard STD1 1.27. See section 18.9 ▪ 1: Trim and Form STD1 2.54. See section 18.10 (not recommended for new designs, prefer STD4 2.54) ▪ 3: Trim and Form STD2 2.54. See section 18.11 ▪ 7: Trim and Form STD3 2.00. See section 18.12 ▪ 8: Trim and Form STD4 2.54. See section 18.13
Packing Form:	-RE : Tape & Reel <ul style="list-style-type: none"> ▪ VS:2500 pcs/reel ▪ DC:3000 pcs/reel ▪ GO:4500 pcs/reel -RX : Tape & Reel, similar to RE with parts face-down (VS package only)
Ordering Example:	MLX90372GDC-ACE-300-RE For a legacy version in SOIC-8 package, delivered in Reel of 3000pcs.

Table 2 - Ordering Codes Information

¹ ACE is preferred product revision to be selected for new designs. ACC remains in production during the entire product lifecycle.

² See section 15.3 Wiring with the MLX90372 in DMP-4 Package (built-in capacitors)

Contents

Features and Benefits.....	1
Application Examples.....	1
Description.....	1
Ordering Information	2
1. Functional Diagram and Application Modes.....	7
2. Glossary of Terms.....	8
3. Pin Definitions and Descriptions.....	9
3.1. Pin Definition for SOIC-8 package.....	9
3.2. Pin Definition for TSSOP-16 package	9
3.3. Pin Definition for DMP#1 - Pinout A package	10
3.4. Pin Definition for DMP#2 - Pinout B package	10
4. Absolute Maximum Ratings.....	11
5. Isolation Specification.....	11
6. General Electrical Specifications.....	12
7. Timing Specification.....	14
7.1. General Timing Specifications	14
7.2. Timing Modes	14
7.3. Timing Definitions.....	16
7.4. SENT timing specifications.....	18
7.5. PWM timing specifications	22
8. Magnetic Field Specifications	23
8.1. Rotary Stray-field Immune Mode - Low Field Variant (-100 code)	23
8.2. Rotary Stray-field Immune Mode - High Field Variant (-500 code)	24
8.3. Linear Stray-field Immune Mode (-200 code)	25
8.4. Standard/Legacy Mode (-300 code)	26
9. Accuracy Specifications.....	28
9.1. Definitions	28
9.2. Rotary Stray-field Immune Mode - Low Field Variant (-100 code)	29
9.3. Rotary Stray-field Immune Mode - High Field Variant (-500 code)	30
9.4. Linear Stray-field Immune Mode.....	30
9.5. Standard/Legacy Mode.....	31
10. Memory Specifications.....	32
11. Digital Output Protocol	33

11.1. Single Edge Nibble Transmission (SENT) SAE J2716	33
11.2. PWM (pulse width modulation).....	42
12. End-User Programmable Items.....	43
12.1. End User Identification Items	47
13. Description of End-User Programmable Items	48
13.1. Output modes.....	48
13.2. Output Transfer Characteristic	49
13.3. Sensor Front-End	57
13.4. Filtering.....	58
13.5. Programmable Diagnostics Settings	59
14. Functional Safety	62
14.1. Safety Manual.....	62
14.2. Safety Mechanisms.....	62
15. Recommended Application Diagrams	66
15.1. Wiring with the MLX90372 in SOIC-8 Package	66
15.2. Wiring with the MLX90372 in TSSOP-16 Package.....	67
15.3. Wiring with the MLX90372 in DMP-4 Package (built-in capacitors).....	68
16. Standard information regarding manufacturability of Melexis products with different soldering processes.....	69
17. ESD Precautions.....	69
18. Package Information	70
18.1. SOIC-8 - Package Dimensions	70
18.2. SOIC-8 - Pinout and Marking	70
18.3. SOIC-8 - Sensitive spot positioning.....	71
18.4. SOIC-8 - Angle detection	72
18.5. TSSOP-16 - Package Dimensions.....	73
18.6. TSSOP-16 - Pinout and Marking.....	74
18.7. TSSOP-16 - Sensitive spot positioning	74
18.8. TSSOP-16 - Angle Detection.....	75
18.9. DMP-4 - Package Outline Dimensions (POD) - STD1 1.27.....	76
18.10. DMP-4 - Package Outline Dimensions (POD) - STD1 2.54.....	77
18.11. DMP-4 - Package Outline Dimensions (POD) - STD2 2.54.....	78
18.12. DMP-4 - Package Outline Dimensions (POD) - STD3 2.00.....	79
18.13. DMP-4 - Package Outline Dimensions (POD) - STD4 2.54.....	80
18.14. DMP-4 - Marking	81

18.15. DMP-4 - Sensitive Spot Positioning	81
18.16. DMP-4 - Angle detection	84
18.17. Packages Thermal Performances.....	84
19. Contact	85
20. Disclaimer	85

1. Functional Diagram and Application Modes



fig. 1 - MLX90372 Block diagram



fig. 2 - Application Modes

2. Glossary of Terms

Name	Description
ADC	Analog-to-Digital Converter
AoU	Assumption of Use
ASP	Analog Signal Processing
AWD	Absolute Watchdog
CPU	Central Processing Unit
CRC	Cyclic Redundancy Check
%DC	Duty Cycle of the output signal i.e. $T_{ON} / (T_{ON} + T_{OFF})$
DMP	Dual Mould Package
DP	Discontinuity Point
DCT	Diagnostic Cycle Time
DSP	Digital Signal Processing
ECC	Error Correcting Code
EMA	Exponential Moving Average
EMC	Electro-Magnetic Compatibility
EoL	End of Line
FIR	Finite Impulse Response
Gauss (G)	Alternative unit for the magnetic flux density (10G = 1mT)
HW	Hardware
IMC	Integrated Magnetic Concentrator
INL / DNL	Integral Non-Linearity / Differential Non-Linearity
IWD	Intelligent Watchdog
LSB/MSB	Least Significant Bit / Most Significant Bit
NC	Not Connected
NVRAM	Non Volatile RAM
POR	Power-on Reset
PSF	Product Specific Functions
PWL	Piecewise Linear
PWM	Pulse Width Modulation
RAM	Random Access Memory
ROM	Read-Only Memory
SEoC	Safety Element out of Context
TC	Temperature Coefficient (in ppm/°C)
Tesla (T)	SI derived unit for the magnetic flux density (Vs/m ²)

Table 3 - Glossary of Terms

3. Pin Definitions and Descriptions

3.1. Pin Definition for SOIC-8 package

Pin #	Name	Description
1	V _{DD}	Supply
2	Input	For test or Application
3	Test	For test or Application
4	N.C.	Not connected
5	OUT	Output
6	V _{SS}	Digital ground
7	V _{DEC}	Decoupling pin
8	V _{SS}	Analog ground

Table 4 - SOIC-8 Pins definition and description

Pins Input and Test are internally grounded in application. For optimal EMC behaviour always connect the unused pins to the ground of the PCB.

3.2. Pin Definition for TSSOP-16 package

Pin #	Name	Description
1	V _{DEC1}	Decoupling pin die1
2	V _{SS1}	Analog ground die1
3	V _{DD1}	Supply die1
4	Input ₁	For test or Application
5	Test ₂	For test or Application
6	OUT ₂	Output die2
7	N.C.	Not connected
8	V _{SS2}	Digital ground die2
9	V _{DEC2}	Decoupling pin die2
10	V _{SS2}	Analog ground die2
11	V _{DD2}	Supply die2
12	Input ₂	For test or Application
13	Test ₁	For test or Application
14	N.C.	Not connected
15	OUT ₁	Output die1
16	V _{SS1}	Digital ground die1

Table 5 - TSSOP-16 Pins definition and description

Pins Input and Test are internally grounded in application. For optimal EMC behaviour always connect the unused pins to the ground of the PCB.

3.3. Pin Definition for DMP#1 - Pinout A package

DMP-4 package pinout A offers a pin to pin compatibility with the previous generation of Triaxis® products.

Pin #	Name	Description
1	V _{SS}	Ground
2	V _{DD}	Supply
3	OUT	Output
4	V _{SS}	Ground

Table 6 - DMP-4 Pins definition and description (pinout A)

3.4. Pin Definition for DMP#2 - Pinout B package

DMP-4 package configuration pinout B offers full benefit of the applications of Input pin (NTC, digital or analog gateway).

Pin #	Name	Description
1	OUT	Output
2	V _{SS}	Ground
3	V _{DD}	Supply
4	Input	NTC/Gateway

Table 7 - DMP-4 Pins definition and description (pinout B)

4. Absolute Maximum Ratings

Parameter	Symbol	Min	Max	Unit	Condition
Supply Voltage	V_{DD}		28	V	< 48h ; $T_j < 175^\circ\text{C}$
	V_{DD}		37	V	< 60s ; $T_{AMB} \leq 35^\circ\text{C}$
Reverse Voltage Protection	V_{DD-rev}	-14		V	< 48h
	V_{DD-rev}	-20		V	< 1h
Positive Output Voltage	V_{OUT}		28	V	< 48h
Reverse Output Voltage	$V_{OUT-rev}$	-14		V	< 48h
Internal Voltage	V_{DEC}		3.6	V	
	$V_{DEC-rev}$	-0.3		V	
Positive Input pin Voltage	V_{Input}		6	V	
Reverse Input pin Voltage	$V_{Input-rev}$	-3		V	
Positive Test pin Voltage	V_{Test}		3.6	V	
Reverse Test pin Voltage	$V_{Test-rev}$	-0.3		V	
Operating Temperature	T_{AMB}	-40	+160	$^\circ\text{C}$	
Junction Temperature	T_j		+175	$^\circ\text{C}$	see 18.17 for package thermal dissipation values
Storage Temperature	T_{ST}	-55	+170	$^\circ\text{C}$	
Magnetic Flux Density	B_{max}	-1	1	T	

Table 8 - Absolute maximum ratings

Exceeding any of the absolute maximum ratings may cause permanent damage.

Exposure to absolute maximum ratings conditions for extended periods may affect device reliability.

5. Isolation Specification

Only valid for the TSSOP-16 package (code GO, i.e. dual die version).

Parameter	Symbol	Min	Typ	Max	Unit	Condition
Isolation Resistance	R_{isol}	4	-	-	$M\Omega$	Between dice, measured between V_{SS1} and V_{SS2} with +/-20V bias

Table 9 - Isolation specification

6. General Electrical Specifications

General electrical specifications are valid for temperature range [-40;160] °C and supply voltage range [4.5;5.5] V unless otherwise noted.

Electrical Parameter	Symbol	Min	Typ	Max	Unit	Condition
Supply Voltage	V _{DD}	4.5	5	5.5	V	For voltage regulated mode
Supply Voltage Battery	V _{DD}	6	12	18	V	For Battery usage ⁽⁴⁾
Supply Current ⁽³⁾	I _{DD}	9.0	10.5	12.6	mA	Rotary and linear stray field applications (option code -100, -200, -500)
Supply Current ⁽³⁾	I _{DD}	8.0	9.0	10.5	mA	Legacy applications (option code -300)
Surge Current	I _{surge}	-	30	40	mA	IC Startup current (t _{startup} < 40µs)
Start-up Level	V _{DDstart}	3.6			V	Minimal supply start-up voltage
PTC Entry Level (rising)	V _{PROV0}	7.10	7.35	7.70	V	Supply overvoltage detection for 5V applications ⁽⁴⁾
PTC Entry Level Hysteresis	V _{PROV0Hyst}	400	500	600	mV	Supply overvoltage hysteresis
PTC Entry Level (rising)	V _{PROV1}	21.5	23.0	24.5	V	For Battery usage ⁽⁴⁾
PTC Entry Level Hysteresis	V _{PROV1Hyst}	0.8	1.4	2.0	V	For Battery usage ⁽⁴⁾
Undervoltage detection	V _{DDUVH}	3.95	4.1	4.25	V	Supply undervoltage high threshold
Undervoltage detection	V _{DDUVL}	3.75	3.90	4.05	V	Supply undervoltage low threshold
Regulated Voltage	V _{DEC}	3.2	3.3	3.4	V	Internal analog voltage
Regulated Voltage Overvoltage detection	V _{DECOVH}	3.65	3.75	3.85	V	High threshold
Regulated Voltage Undervoltage detection	V _{DECUVL}	2.70	2.85	2.92	V	Low threshold
Regulated voltage UV / OV detection hysteresis	V _{DECOVHyst} V _{DECUVHyst}	100	150	200	mV	
Digital supply	V _{DDD}	1.80	1.85	1.95	V	
Digital supply Overvoltage detection	V _{DDDOVH}	2.00	2.10	2.20	V	
Digital Supply Undervoltage detection	V _{DDDUVL}	1.585	1.680	1.735	V	Power-on Reset low threshold
Digital Supply OV / UV detection Hysteresis	V _{PORHyst}	30	100	200	mV	

Table 10 - Supply System Electrical Specifications

³ For the dual die version, the supply current is multiplied by 2.

⁴ Selection between 5V or battery applications is done using WARM_ACT_HIGH parameter. See chap.12

Electrical Parameter	Symbol	Min	Typ	Max	Unit	Condition
Output Short Circuit Current ⁽⁵⁾	I _{OUTshortPP}	-25		-10	mA	Push-pull modes (SENT, PWM) V _{OUT} = 0 V
		10		25	mA	V _{OUT} = 5 V .. 18V
Output Short Circuit Current	I _{OUTshortOD1}	10		25	mA	SENT Open Drain (see 13.1.1) V _{OUT} = 5V
Output Short Circuit Current	I _{OUTshortOD2}	25		90	mA	PWM mode Open Drain only (see 13.1.1)
Output Load	R _L	3			kΩ	PWM pull-up to 5V, PWM pull-down to 0V
	R _L	10	-	55	kΩ	SENT pull-up
	R _L	1	-	100	kΩ	Open drain pull-up
Digital push-pull output level	V _{satLoPP}	0	1	2 5	%V _{DD}	R _L ≥ 10kΩ R _L ≥ 3kΩ, pull-up to 5V
	V _{satLoPP}	0	-	2.5	%V _{DD}	R _L ≥ 10kΩ, ADE version
	V _{satHiPP}	98 95	99	100	%V _{DD}	R _L ≥ 10kΩ R _L ≥ 3kΩ, pull-down
	V _{satHiPP}	97.5	-	100	%V _{DD}	R _L ≥ 10kΩ, ADE version
Digital open drain output level	V _{satLoOD}	0		10	%V _{ext}	Pull-up to any external voltage V _{ext} ≤ 18V, I _L ≤ 3.4mA
Digital output Ron	R _{on}	27	50	100	Ω	ACC and ACE chip revision. Push-pull mode
Digital output Ron	R _{on}	50	100	215	Ω	ADE chip revision. Push-pull mode

Table 11 - Output Electrical specifications

⁵ Output current limitation triggers after a typical delay of 3μs.

7. Timing Specification

Timing specifications are valid for temperature range [-40;160] °C and supply voltage range [4.5; 5.5] V unless otherwise noted.

7.1. General Timing Specifications

Parameter	Symbol	Min.	Typ	Max.	Unit	Condition
Main Clock Frequency	F_{CK}	22.8	24	25.2	MHz	Including thermal and lifetime drift
		-5		5	% F_{ck}	Relative tolerances, including thermal and lifetime drift
Main Clock initial tolerances	$\Delta F_{CK,0}$	23.75	24	24.25	MHz	T=35°C
Main Clock Frequency Thermal Drift	$\Delta F_{CK,T}$	-2	-	2	% F_{ck}	Relative to clock frequency at 35°C. No ageing effects.
1MHz Clock Frequency	F_{1M}		1		MHz	
Intelligent Watchdog Timeout	T_{IWD}	19	20	21	ms	$F_{CK} = 24\text{MHz}$
Absolute Watchdog Timeout	T_{AWD}	19	20	21	ms	$F_{1M} = 1\text{MHz}$
Analog Diagnostics DCT	DCT_{ANA}	34		34	$T_{\text{angle-Meas}}$	Asynchronous mode (7.2.1)
		17		17	T_{frame}	Sync. Mode, $N_{\text{angFram}}=2$
		34		34	T_{frame}	Sync. Mode, $N_{\text{angFram}}=1$
Digital Diagnostics DCT	DCT_{DIG}			20	ms	see Table 72, section 14.2
Fail Safe state duration	T_{FSS}	9.8	11.0	11.9	ms	After a digital single-event fault ACE / ADE versions
		28.4	32.0	34.6		ACC version
Safe Startup Time	T_{SafeStup}	-	11.2	12.4	ms	Only valid for ACE / ADE versions (see. 7.3.1.2)

Table 12 - General Timing Specifications

7.2. Timing Modes

The MLX90372 can be configured in two continuous angle acquisition modes described in the following sections.

7.2.1. Continuous Asynchronous Acquisition Mode

In this mode, the sensor continuously acquire angle at a fixed rate that is asynchronous with regards to the output. The acquisition rate is defined by the $T_{\text{ADC_SEQ}}$ parameter which defines the angle measurement period $T_{\text{angleMeas}}$. This mode is used in SENT without pause and PWM. Despite that PWM is periodic, asynchronous mode is better suited and enable complete filtering options for PWM signals that are often slow compared to the measurement sequence.



fig. 3 - Continuous Asynchronous Timing Mode

Parameter	Symbol	Min.	Typ	Max.	Unit	Condition
Angle acquisition time	$T_{angleAcq}$		330		μs	
Internal Angle Measurement Period	$T_{angleMeas}$	528	588	-	μs	Typical is default factory settings (no user control)
SENT Frame Tick Count	N_{Tframe}	282	-	-	ticks	Do not change for asynchronous mode (see chap.12, T_FRAME)

Table 13 - Continuous Asynchronous Timing Mode

7.2.2. Continuous Synchronous Acquisition Mode

In continuous synchronous timing mode, the sensor acquires angles based on the output frequency. As a consequence, the output should have a fixed frame frequency. This mode makes sense only with constant SENT frame length (SENT with pause). The length of the SENT frame is defined by the parameter T_FRAME in number of ticks. The user has the choice to select either one or two angle acquisitions and DSP calculations per frame.



fig. 4 - Continuous Synchronous Timing Mode

Following table describes the frame length of synchronous acquisition mode with regards to T_FRAME parameter value (see chap. 12). Minimal values represent MLX90372 best achievable performance. Typical values are default or recommended values. Maximal values are limited by the SAE J2716 standard and not displayed in this table. For a chosen timing configuration, one has to take into account the main clock relative tolerances listed in Table 12 to get a tolerance on the frame length.

Parameter	Symbol	Min	Typ	Max	Unit	Condition
SENT Frame Tick Count (Normal SENT)	N _{Tframe}	310 ⁽⁶⁾	320	-	ticks	For tick time of 3μs (Normal SENT) and two angles per frame
SENT Frame Tick Count (Normal SENT)	N _{Tframe}	282 ⁽⁶⁾	304 ⁽⁷⁾	-	ticks	For tick time of 3μs (Normal SENT) and one angle per frame
SENT Frame Tick Count (Fast SENT)	N _{Tframe}	320 ⁽⁶⁾	330	-	ticks	For tick time of 1.5μs (Fast SENT) and one angle per frame
SENT Frame Period (Normal)	T _{frame}	930 ⁽⁶⁾	960	-	μs	3μs tick time with pause and two angles per frame (F _{CK} = 24MHz)
SENT Frame Period (Fast)	T _{frame}	480 ⁽⁶⁾	495	-	μs	1.5μs tick time with pause, one angle per frame (F _{CK} = 24MHz)
Number of angles per frame	N _{angFrame}	1	2	2		set by TWO_ANGLES_FRAME parameter

Table 14 - SENT Synchronous Timing Mode Configurations

7.3. Timing Definitions

7.3.1. Startup Time and Startup Phases definition

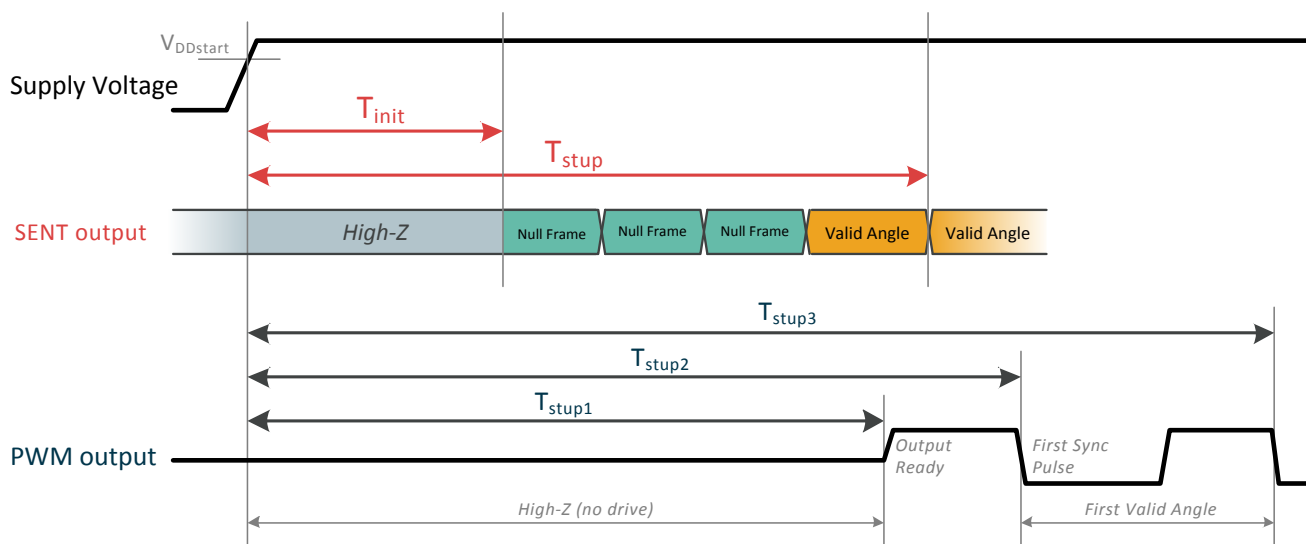

fig. 5 - Startup Time Definition

⁶ Minimal timings are only confirmed to work in a specific configuration and may lead to noise degradation. Melexis recommends typical configuration (factory settings) for safe operation with any end user configuration.

⁷ This timing optimizes the startup time (see Table 17)

7.3.1.1. Normal Startup

A typical startup in SENT consists of two main phases. During the first one, the circuit performs its initialisation until being able to start acquiring angles and transmitting SENT frames. This first phase lasts T_{init} milliseconds. After that time, the IC starts transmitting SENT initialisation frames, also called null frames, their content being mainly zeros. During the second phase, the sensor acquires angles until the amplification chain gain settles. The overall startup time T_{stup} is the time between power up and complete transmission of the first valid angle.

7.3.1.2. Safe Startup

When `COLD_SAFE_STARTUP_EN` is set (see chap. 12, End-User Programmable Items), the circuit performs a full diagnostic cycle before starting the transmission of an angle. This sequence lasts $T_{SafeStup}$ milliseconds (see Table 12 - General Timing Specifications). After T_{init} , the circuit start sending null SENT frames until the full diagnostic sequence is complete.

7.3.1.3. Startup phase in PWM mode

In PWM mode, startup is defined by three values, $T_{stup[1..3]}$. The first value is reached when the output is ready and starts to drive a voltage. The second value T_2 is the start of the first value angle transmission and the third one T_3 the moment the first angle has been transmitted.

7.3.2. Latency (average)

Latency is the average lag between the movement of the detected object (magnet) and the response of the sensor output. This value is representative of the time constant of the system for regulation calculations.



fig. 6 - Definition of Latency

7.3.3. Step Response (worst case)

Step response is defined as the delay between a change of position of the magnet and the 100% settling time of the sensor output with full angle accuracy with regards to filtering. Worst case is happening when the movement of the magnet occurs just after a measurement sequence has begun. Step response therefore consists of the sum of:

- $\delta_{mag,measSeq}$, the delay between magnetic change and start of next measurement sequence
- $T_{measSeq}$, the measurement sequence length
- $\delta_{measSeq,frameStart}$, the delay between end of measurement sequence and start of next frame
- T_{frame} , the frame length

Worst case happens when $\delta_{mag,measSeq} = T_{measSeq}$, which gives:

$$T_{wcStep} = 2T_{measSeq} + \delta_{measSeq,frameStart} + T_{frame}$$

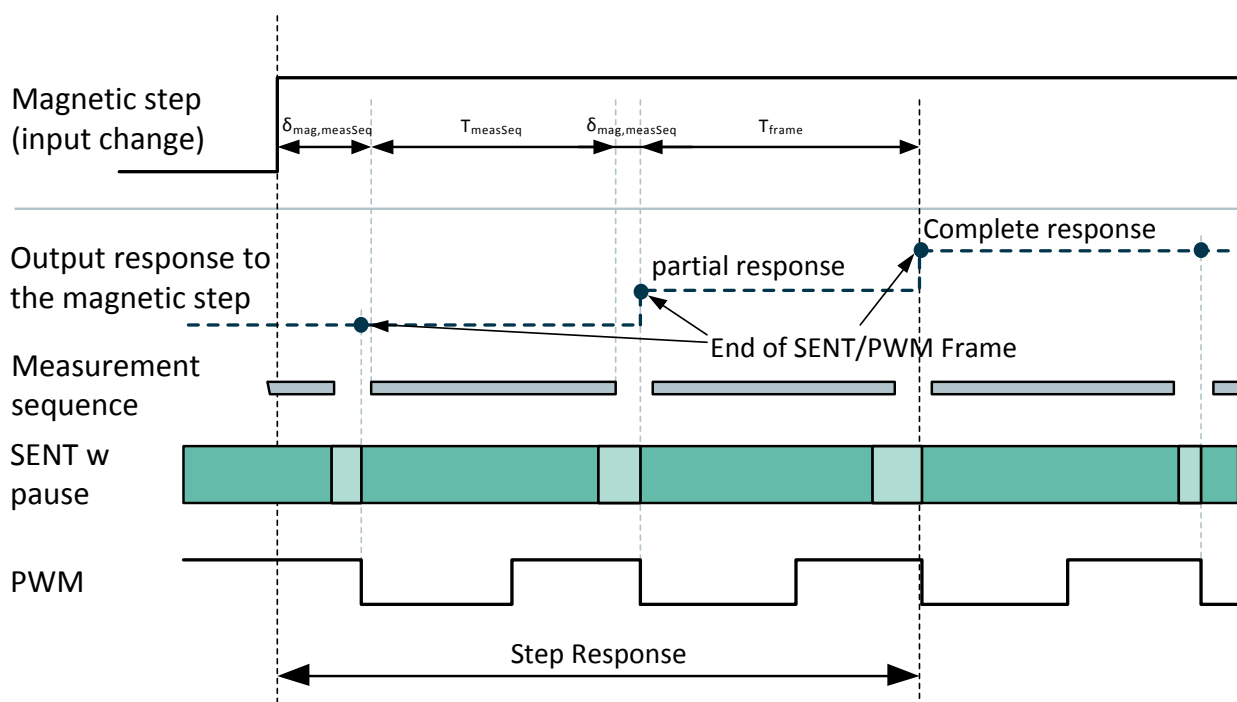

fig. 7 - Step Response Definition

7.4. SENT timing specifications

7.4.1. MLX90372 ACE/ADE SENT Timing Specifications

Timing specifications are valid for a given configuration of the SENT frame and tick time (see 11.1.9)

Parameter	Symbol	Min	Typ	Max	Unit	Condition
Tick time		1.5	3	6	μs	1.5μs = Fast SENT 3μs = Normal SENT (default) 6μs = Slow SENT
SENT startup time (up to first sync pulse)	T_{init}	-	2.95	3.10	ms	Until initialisation frame start
SENT edge rise Time		4.5	6.2	7.5	μs	for SENT_SEL_SR_RISE/FALL = 4 (see 11.1.6)
SENT edge fall Time		3.9	4.8	5.2	μs	
Slow Message cycle length			691 415		ms	Extended sequence (40 frames) Short sequence (24 frames)

Table 15 - SENT General Timing Specifications

Parameter	Symbol	Min	Typ	Max	Unit	Condition
For SENT with pause (synchronous), 3µs tick time, 2 angles per SENT frame, T_FRAME = 310						
SENT startup time	T _{stup}	-	6.48	-	ms	Until first valid angle received
Average Latency	T _{latcy}	-	1.73 2.19	-	ms	Filter = 1 (FIR11) Filter = 2 (FIR1111) ⁽⁸⁾
Step Response (worst case)	T _{wcStep}	-	-	2.98 3.91	ms	Filter = 1 (FIR11) Filter = 2 (FIR1111) ⁽⁸⁾
For SENT with pause (synchronous), 3µs tick time, 2 angles per SENT frame, T_FRAME = 320						
SENT startup time	T _{stup}	-	6.60	-	ms	Until first valid angle received
Average Latency	T _{latcy}	-	1.77 2.25	-	ms	Filter = 1 (FIR11) Filter = 2 (FIR1111) ⁽⁸⁾
Step Response (worst case)	T _{wcStep}	-	-	3.12 4.08	ms	Filter = 1 (FIR11) Filter = 2 (FIR1111) ⁽⁸⁾
For SENT with pause (synchronous), 3µs tick time, 1 angle per SENT frame, T_FRAME = 282						
SENT startup time	T _{stup}	-	6.99	-	ms	Until first valid angle received
Average Latency	T _{latcy}	-	1.33	-	ms	Filter = 0 (no filter)
Step Response (worst case)	T _{wcStep}	-	-	2.32	ms	Filter = 0 (no filter)
For SENT with pause (synchronous), 3µs tick time, 1 angle per SENT frame, T_FRAME = 304						
SENT startup time	T _{stup}	-	6.41	-	ms	Until first valid angle received
Average Latency	T _{latcy}	-	1.54	-	ms	Filter = 0 (no filter)
Step Response (worst case)	T _{wcStep}	-	-	2.60	ms	Filter = 0 (no filter)

Table 16 - Synchronous SENT Mode Timing Specifications for 3µs tick time

Parameter	Symbol	Min	Typ	Max	Unit	Condition
For SENT with pause (synchronous), 1.5µs tick time, 1 angle per SENT frame, T_FRAME = 320						
SENT startup time	T _{stup}	6.12	6.23	-	ms	Until first valid angle received
Average Latency	T _{latcy}	-	0.98 1.15 1.31	-	ms	Filter = 0 (no filter) Filter = 1 (FIR11) Filter = 2 (FIR1111) ⁽⁸⁾
Step Response (worst case)	T _{wcStep}	-	-	1.58 1.89 2.20	ms	Filter = 0 (no filter) Filter = 1 (FIR11) Filter = 2 (FIR1111) ⁽⁸⁾

⁸ See section 13.4 for details concerning Filter parameter

Parameter	Symbol	Min	Typ	Max	Unit	Condition
For SENT with pause (synchronous), 1.5µs tick time, 1 angle per SENT frame, T_FRAME = 330						
SENT startup time	T _{stup}	6.12	6.23	-	ms	Until first valid angle received
Average Latency	T _{latcy}	-	1.05	-	ms	Filter = 0 (no filter)
			1.21			Filter = 1 (FIR11)
			1.37			Filter = 2 (FIR1111) ⁽⁸⁾
Step Response (worst case)	T _{wcStep}	-	-	1.63 1.95 2.27	ms	Filter = 0 (no filter) Filter = 1 (FIR11) Filter = 2 (FIR1111) ⁽⁸⁾

Table 17 - Synchronous SENT Mode Timing Specifications for 1.5us tick time

Parameter	Symbol	Min	Typ	Max	Unit	Condition
For SENT without pause (asynchronous), 3µs tick time⁽⁹⁾						
SENT startup time	T _{stup}	6.25 6.42	6.39 6.56	6.51 6.68	ms	Until first valid angle received with SENT_INIT_GM = 1
Average Latency ⁽⁹⁾	T _{latcy}	1.40 1.67 2.20	1.40 1.70 2.29	-	ms	Filter = 0 (no filter)
						Filter = 1 (FIR11)
						Filter = 2 (FIR1111) ⁽⁸⁾
Step Response (worst case)	T _{wcStep}	-	2.41 2.94 4.00	2.72 3.32 4.50	ms	Filter = 0 (no filter) Filter = 1 (FIR11) Filter = 2 (FIR1111) ⁽⁸⁾
For SENT without pause (asynchronous), 1.5µs tick time⁽⁹⁾						
SENT startup time	T _{stup}	6.42	6.50	6.56	ms	Until first valid angle received
Average Latency ⁽⁹⁾	T _{latcy}	0.91 1.17 1.70	0.91 1.21 1.80	-	ms	Filter = 0 (no filter)
						Filter = 1 (FIR11)
						Filter = 2 (FIR1111) ⁽⁸⁾
Step Response (worst case)	T _{wcStep}	-	1.76 2.29 3.34	1.94 2.54 3.72	ms	Filter = 0 (no filter) Filter = 1 (FIR11) Filter = 2 (FIR1111) ⁽⁸⁾

Table 18 - Asynchronous SENT Mode Timing Specifications

⁹In asynchronous mode, the latency is defined as an average delay with regards to all possible variations. For worst case, refer to step response (worst case) values

7.4.2. MLX90372 ACC Default SENT Timing specifications

MLX90372 ACC versions come with the following typical default programming that differs from ACE/ADE version (see chapter 12, item no 134, T_FRAME).

Parameter	Symbol	Min	Typ	Max	Unit	Condition
SENT Frame Tick Count (Normal SENT)	N_{Tframe}	-	366	-	ticks	For tick time of 3 μ s (Normal SENT) and two angles per frame
Slow Message cycle length			791 475		ms	Extended sequence (40 frames) Short sequence (24 frames)

Table 19 - Default ACC Synchronous SENT frame length

For this typical value, the timing performances are described in the next table (Table 20). ACC has the same timing capabilities than the ACE and can be programmed in a similar way. When the ACC default programming is changed to match the one of ACE/ADE, timing performances are equivalent. For timing performances not described in this section, refer to the Table 14 and section 7.4.1.

Parameter	Symbol	Min	Typ	Max	Unit	Condition
For SENT with pause (synchronous), 3μs tick time, 2 angles per SENT frame						
SENT startup time	T_{stup}	-	7.18	-	ms	Until first valid angle received
Average Latency	T_{latcy}	-	1.79 2.33	-	ms	Filter = 1 (FIR11) Filter = 2 (FIR1111) ⁽¹⁰⁾
Step Response (worst case)	T_{wcStep}	-	-	3.28 4.38	ms	Filter = 1 (FIR11) Filter = 2 (FIR1111) ⁽⁸⁾
For SENT with pause (synchronous), 3μs tick time, 1 angle per SENT frame⁽¹¹⁾						
SENT startup time	T_{stup}	-	6.60	-	ms	Until first valid angle received
Average Latency	T_{latcy}	-	1.49	-	ms	Filter = 0 (no filter)
Step Response (worst case)	T_{wcStep}	-	-	2.61	ms	Filter = 0 (no filter)

Table 20 - Synchronous SENT mode ACC default timing specifications

¹⁰ See section 13.4 for details concerning Filter parameter

¹¹ Need experimental/formal confirmation, data based on simulation

7.5. PWM timing specifications

For the parameters in below table, maximum timings correspond to minimal frequency and vice versa.

Parameter	Symbol	Min	Typ	Max	Unit	Condition
PWM Frequency	F_{PWM}	100	1000	2000	Hz	
PWM Frequency Initial Tolerances	$\Delta F_{PWM,0}$	-1.5		1.5	% F_{PWM}	T=35°C, can be trimmed at EOL
PWM Frequency Thermal Drift	$\Delta F_{PWM,T}$	-2.0		2.0	% F_{PWM}	
PWM Frequency Drift	ΔF_{PWM}	-5.0		5.0	% F_{PWM}	Over temperature and lifetime
PWM startup Time (up to output ready)	T_{stup1}		6.60		ms	
PWM startup Time (up to first sync. Edge)	T_{stup2}	7.10	7.60	16.6	ms	$T_{stup1} + T_{PWM}$
PWM startup Time (up to first data received)	T_{stup3}	7.60	8.60	26.6	ms	$T_{stup1} + 2 * T_{PWM}^{(12)}$
Rise Time PWM		1.0	4.8	12.0	μs	typ. for SENT_SEL_SR_RISE/FALL = 4 (see 11.1.6). Measured between 1.1V and 3.8V
Fall Time PWM		1.0	4.8	12.0	μs	

Table 21 - PWM timing specifications

¹² First frame transmitted has no synchronization edge; therefore the second frame transmitted is the first complete one.

8. Magnetic Field Specifications

Magnetic field specifications are valid for temperature range [-40; 160] °C unless otherwise noted.

8.1. Rotary Stray-field Immune Mode - Low Field Variant (-100 code)

Parameter	Symbol	Min	Typ	Max	Unit	Condition
Number of magnetic poles	N_p	4 ⁽¹³⁾	-	-		
Magnetic Flux Density in X-Y plane	B_x, B_y ⁽¹⁴⁾			25 ⁽¹⁵⁾	mT	$\sqrt{B_x^2 + B_y^2}$ (this is not the useful signal)
Magnetic Flux Density in Z	B_z			100	mT	(this is not the useful signal)
Magnetic in-plane gradient of in-plane field component	$\frac{\Delta B_{XY}}{\Delta XY}$	3.8	10		$\frac{mT}{mm}$	$\frac{1}{2} \sqrt{\left(\frac{dB_x}{dX} - \frac{dB_y}{dY}\right)^2 + \left(\frac{dB_x}{dY} + \frac{dB_y}{dX}\right)^2}$ this is the useful signal (see fig. 8)
Magnet Temperature Coefficient	TC_m	-2400		0	$\frac{ppm}{^\circ C}$	
Field Strength Resolution ⁽¹⁶⁾	$\frac{\Delta B_{XY}}{\Delta XY}$	0.075	0.100	0.125	$\frac{mT}{mm \text{ LSB}}$	Magnetic field gradient norm (12bits data)
Field too Low Threshold ⁽¹⁷⁾	B_{TH_LOW}	0.8	1.2	⁽¹⁸⁾	$\frac{mT}{mm}$	Typ is recommended value to be set by user
Field too High Threshold ⁽¹⁷⁾	B_{TH_HIGH}	70	100 ⁽¹⁹⁾	102 ⁽¹⁹⁾	$\frac{mT}{mm}$	Typ is recommended value to be set by user

Table 22 - Magnetic specification for rotary stray-field immune- low field variant

Nominal performances apply when the useful signal $\Delta B_{XY}/\Delta XY$ is above the typical specified limit. Under this value, limited performances apply. See 8.1 for accuracy specifications.

¹³ Due to 4 poles magnet usage, maximum angle measurement range is limited to 180°

¹⁴ The condition must be fulfilled for all combinations of B_x and B_y .

¹⁵ Above this limit, the IMC® starts to saturate, yielding to an increase of the linearity error.

¹⁶ Only valid with default MAGNET_SREL_T[1..7] configuration

¹⁷ Typ. value is set by default for NVRAM rev.9 and shall be set by user for rev.8 (see Table 50, USER_ID3 and Table 49)

¹⁸ Higher values of Field too Low threshold are not recommended by Melexis and shall only be set in accordance with the magnetic design and taking a sufficient safety margin to prevent false positive.

¹⁹ Due to the saturation effect of the IMC, the FieldTooHigh monitor detects only defects in the sensor



fig. 8 - Minimum useful signal definition for rotary stray-field immune application-low field variant

8.2. Rotary Stray-field Immune Mode - High Field Variant (-500 code)

Parameter	Symbol	Min	Typ	Max	Unit	Condition
Number of magnetic poles	N_p	4 ⁽¹³⁾	-	-		
Magnetic Flux Density in X-Y plane	B_x, B_y ⁽¹⁴⁾			67 ⁽¹⁵⁾	mT	$\sqrt{B_x^2 + B_y^2}$ (this is not the useful signal)
Magnetic Flux Density in Z	B_z			100	mT	(this is not the useful signal)
Magnetic in-plane gradient of in-plane field component	$\frac{\Delta B_{XY}}{\Delta XY}$	8.25	21		$\frac{mT}{mm}$	$\frac{1}{2} \sqrt{\left(\frac{dB_x}{dX} - \frac{dB_y}{dY}\right)^2 + \left(\frac{dB_x}{dY} + \frac{dB_y}{dX}\right)^2}$ this is the useful signal.
Magnet Temperature Coefficient	TC_m	-2400		0	$\frac{ppm}{^\circ C}$	
Field Strength Resolution ⁽¹⁶⁾	$\frac{\Delta B_{XY}}{\Delta XY}$	0.075	0.100	0.125	$\frac{mT}{mm}$ LSB	Magnetic field gradient norm (12bits data)
Field too Low Threshold ⁽¹⁷⁾	B_{TH_LOW}	1.2	2	⁽¹⁸⁾	$\frac{mT}{mm}$	Typ is recommended value to be set by user
Field too High Threshold ⁽¹⁷⁾	B_{TH_HIGH}	80	100 ⁽¹⁹⁾	102 ⁽¹⁹⁾	$\frac{mT}{mm}$	Typ is recommended value to be set by user

Table 23 - Magnetic specification for rotary stray-field immune

See 8.2 for accuracy specifications.

8.3. Linear Stray-field Immune Mode (-200 code)

Parameter	Symbol	Min	Typ	Max	Unit	Condition
Number of magnetic poles	N _p		2	-		Linear movement
Magnetic Flux Density in X	B _x			80 ⁽²⁰⁾	mT	B _y ≤ 20mT
Magnetic Flux Density in X-Y	B _x , B _y ⁽²¹⁾			70 ⁽²²⁾	mT	$\sqrt{B_x^2 + B_y^2}$, B _y >20mT
Magnetic Flux Density in Z	B _z			100	mT	
Magnetic gradient of X-Z field components	$\frac{\Delta B_{XZ}}{\Delta X}$	3	6 ⁽²³⁾		$\frac{\text{mT}}{\text{mm}}$	$\sqrt{\left(\frac{\Delta B_X}{\Delta X}\right)^2 + \left(\frac{1}{G_{IMC}} \frac{\Delta B_Z}{\Delta X}\right)^2}$ ⁽²⁴⁾
Distance between the two IMC®	ΔX		1.91		mm	see chapter 18 for magnetic center definitions
IMC gain	G _{IMC}		1.19			see ⁽²⁴⁾
Magnet Temperature Coefficient	TC _m	-2400		0	$\frac{\text{ppm}}{^\circ\text{C}}$	
Field Strength Resolution ⁽¹⁶⁾	$\frac{\Delta B_{XZ}}{\Delta X}$	0.037	0.05	0.063	$\frac{\text{mT}}{\text{mm LSB}}$	Magnetic field gradient norm expressed in 12bits words
Field too Low Threshold ⁽¹⁷⁾	B _{TH_LOW}	0.2	1.2	⁽²⁵⁾	$\frac{\text{mT}}{\text{mm}}$	Typ is recommended value to be set by user
Field too High Threshold ⁽¹⁷⁾	B _{TH_HIGH}	35	50	51	$\frac{\text{mT}}{\text{mm}}$	Typ is recommended value to be set by user

Table 24 - Magnetic specifications for linear stray-field application

Nominal performances apply when the useful signal $\Delta B_{xz}/\Delta x$ and temperature ranges are inside the values defined in the following figure (fig. 9). At higher temperature or lower field gradients, the accuracy of MLX90372 is degraded and Limited Performances, described in section 9.4.2, apply.

²⁰ Above 80 mT, with B_y field in the mentioned limits, the IMC® starts saturating yielding to an increase of the linearity error.

²¹ The condition must be fulfilled for all combinations of B_x and B_y.

²² Above 70 mT, the IMC® starts saturating yielding to an increase of the linearity error.

²³ Below 6 mT/mm, the performances are degraded due to a reduction of the signal-to-noise ratio, signal-to-offset ratio.

²⁴ IMC has better performance for concentrating in-plane (X-Y) field components, resulting in a better magnetic sensitivity. A correction factor, called IMC gain has to be applied to the Z field component to account for this difference.

²⁵ Higher values of Field too Low threshold are not recommended by Melexis and shall only be set in accordance with the magnetic design and taking a sufficient safety margin to prevent false positive.



fig. 9 - Minimum useful signal definition for linear stray-field immune application

8.4. Standard/Legacy Mode (-300 code)

Parameter	Symbol	Min.	Typ.	Max.	Unit	Condition
Number of magnetic poles	N_P	-	2	-		
Magnetic Flux Density in X-Y plane	$B_x, B_y^{(21)}$			70	mT	$\sqrt{B_x^2 + B_y^2}$
Magnetic Flux Density in Z	B_z			100	mT	in absolute value
Useful Magnetic Flux Density Norm	B_{Norm}	$10^{(26)}$	20		mT	$\sqrt{B_x^2 + B_y^2}$ (X-y mode) $\sqrt{B_x^2 + \left(\frac{1}{G_{IMC}} B_z\right)^2}$ (X-Z mode) $\sqrt{B_y^2 + \left(\frac{1}{G_{IMC}} B_z\right)^2}$ (Y-Z mode) see 13.3.1 for sensing mode description.
IMC gain	G_{IMC}		1.19			see ²⁷
Magnet Temperature Coefficient	TC_m	-2400		0	$\frac{ppm}{^\circ C}$	
Field Strength Resolution ⁽²⁸⁾	B_{Norm}	0.075	0.100	0.125	$\frac{mT}{LSB}$	Magnetic field gradient norm expressed in 12bits words

²⁶ Below 10 mT the performances are degraded due to a reduction of the signal-to-noise ratio, signal-to-offset ratio

²⁷ IMC has better performance for concentrating in-plane (X-Y) field components, resulting in a better overall magnetic sensitivity. A correction factor, called IMC gain has to be applied to the Z field component to account for this difference.

Parameter	Symbol	Min.	Typ.	Max.	Unit	Condition
Field Too Low Threshold ⁽²⁹⁾	B _{TH_LOW}	0.4	4.0	(25)	mT	Typ is recommended value to be set by user
Field Too High Threshold ⁽²⁹⁾	B _{TH_HIGH}	70	100 ⁽³⁰⁾	100 ⁽³⁰⁾	mT	Typ is recommended value to be set by user

Table 25 - Magnetic specifications for Standard application

Nominal performances apply when the useful signal B_{Norm} is above the typical specified limit. Under this value, limited performances apply. See 9.5 for accuracy specifications.

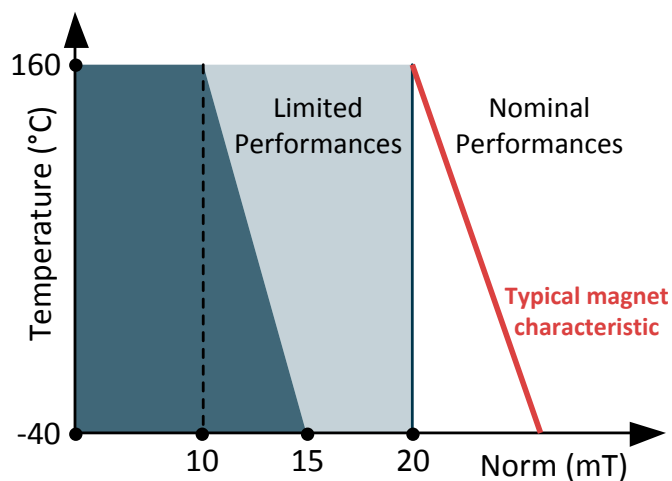

fig. 10 - Minimum useful signal definition for Standard/Legacy application

²⁸ Only valid with default MAGNET_SREL_T[1..7] configuration

²⁹ Typ. value is set by default for NVRAM rev.9 and shall be set by user for rev.8 (see Table 50, USER_ID3 and Table 49)

³⁰ Due to the saturation effect of the IMC, the FieldTooHigh monitor detects only defects in the sensor

9. Accuracy Specifications

Accuracy specifications are valid for temperature range [-40;160] °C and supply voltage range [4.5 - 5.5] V unless otherwise noted.

9.1. Definitions

This section defines several parameters, which will be used for the magnetic specifications.

9.1.1. Intrinsic Linearity Error



fig. 11 - Sensor accuracy definition

Illustration of fig. 11 depicts the intrinsic linearity error in new parts. The Intrinsic Linearity Error refers to the IC itself (offset, sensitivity mismatch, orthogonality) taking into account an ideal magnetic field. Once associated to a practical magnetic construction and the associated mechanical and magnetic tolerances, the output linearity error increases. However, it can be improved with the multi-point end-user calibration (see 13.2). As a consequence, this error is not critical in application because it is calibrated away.

9.1.2. Total Angle Drift

After calibration, the output angle of the sensor might still change due to temperature change, aging, etc.. This is defined as the total drift $\partial\theta_{TT}$:

$$\partial\theta_{TT} = \max\{\theta(\theta_{IN}, T, t) - \theta(\theta_{IN}, T_{RT}, t_0)\}$$

where θ_{IN} is the input angle, T is the temperature, T_{RT} is the room temperature, and t is the elapsed lifetime after calibration. t_0 represents the status at the start of the operating life. Note the total drift $\partial\theta_{TT}$ is always defined with respect to angle at room temperature. In this datasheet, T_{RT} is typically defined at 35°C, unless stated otherwise. The total drift is valid for all angles along the full mechanical stroke.

9.2. Rotary Stray-field Immune Mode - Low Field Variant (-100 code)

9.2.1. Nominal Performance

Valid before EoL calibration and for all applications under nominal performances conditions described in section 8.1 (fig. 8) and chapter 6.

Parameter	Symbol	Min	Typ	Max	Unit	Condition
XY - Intrinsic Linearity Error	L_{E_XY}	-1		1	Deg.	
Noise ⁽³¹⁾				0.2 0.4	Deg.	Filter = 2 Filter = 0 ⁽³²⁾
XY - Total Drift ⁽³³⁾	$\partial\theta_{TT_XY}$	-0.85		0.85	Deg.	Relative to 35°C
Hysteresis			0.1		Deg.	
Output Stray Field Immunity	$\partial\theta_{FF}$			0.6	Deg.	with 10mT/mm useful gradient field and 4kA/m stray-field ⁽³⁴⁾

Table 26 - Rotary stray-field immune nominal magnetic performances

9.2.2. Limited Performances

Valid before EoL calibration and for all applications under limited performances conditions described in section 8.1 (fig. 8) and chapter 6.

Parameter	Symbol	Min	Typ	Max	Unit	Condition
XY - Intrinsic Maximum Error	L_E	-1		1	Deg.	
Noise ⁽³¹⁾				0.7 0.5 0.35	Deg.	Filter = 0 Filter = 1 Filter = 2
XY - Total Drift ⁽³³⁾	$\partial\theta_{TT_XY}$	-0.85		0.85	Deg.	Relative to 35°C
Hysteresis			0.1		Deg.	

Table 27 - Rotary stray-field immune limited magnetic performances

³¹ $\pm 3\sigma$

³² See section 13.4 for details concerning Filter parameter

³³ Verification done on new and aged devices in an ideal magnetic field gradient (see 9.1.2). An additional application-specific error arises from the non-ideal magnet and mechanical tolerance drift.

³⁴ Tested in accordance with ISO 11452-8:2015, at 30°C, with stray-field strength of 4kA/m from any direction. This error scales linearly with both the useful field and the disturbing field.

9.3. Rotary Stray-field Immune Mode - High Field Variant (-500 code)

Valid before EoL calibration and for all applications under nominal performances conditions described in section 8.2 and chapter 6.

Parameter	Symbol	Min	Typ	Max	Unit	Condition
XY - Intrinsic Linearity Error	L_{E_XY}	-1		1	Deg.	
Noise ⁽³¹⁾				0.25 0.35 0.5	Deg.	Filter = 2 Filter = 1 Filter = 0 ⁽³²⁾
XY - Total Drift ⁽³³⁾	$\partial\theta_{TT_XY}$	-0.67 -0.60		0.67 0.60	Deg.	for the full temperature range for $T_{max} = 140^{\circ}C$
Hysteresis			0.1		Deg.	
Output Stray Field Immunity	$\partial\theta_{FF}$			0.30	Deg.	with 21mT/mm useful gradient field and 4kA/m stray-field ⁽³⁴⁾

Table 28 - Rotary stray-field immune nominal magnetic performances

9.4. Linear Stray-field Immune Mode (-200 code)

9.4.1. Nominal Performances

Valid before EoL calibration and for all applications under nominal conditions described in section 8.3 (fig. 9) and chapter 6.

Parameter	Symbol	Min	Typ	Max	Unit	Condition
XZ - Intrinsic Maximum Error	L_{E_XZ}	-2.5	± 1.25	2.5	Deg.	
Noise ⁽³¹⁾			0.10 0.15 -	0.20 0.30 0.25	Deg.	Filter = 1, 6mT/mm Filter = 0, 6mT/mm Filter = 0, 6mT/mm, $T_{max}=125^{\circ}C$
XZ - Total Drift ⁽³³⁾	$\partial\theta_{TT_XZ}$	-0.8		0.8	Deg.	Compared to $35^{\circ}C$, 6mT/mm gradient field
Hysteresis				0.10	Deg.	6mT/mm gradient field
Output Stray Field Immunity	$\partial\theta_{FF}$			0.8	Deg.	For 6mT/mm gradient field and 4kA/m stray-field ⁽³⁴⁾
Output Stray Field Immunity	$\partial\theta_{FF}$			0.2	Deg.	For 6mT/mm gradient field and 1kA/m stray-field ⁽³⁴⁾

Table 29 - Linear stray-field immune magnetic performances

9.4.2. Limited Performances

Valid before EoL calibration and for all applications under limited performances conditions described in section 8.3 (fig. 9) and chapter 6.

Parameter	Symbol	Min	Typ	Max	Unit	Condition
XZ - Intrinsic Maximum Error	L_{E_XZ}	-4	± 2	4	Deg.	
Noise ⁽³⁵⁾			0.20	0.40		Filter = 1, 3mT/mm
			0.25	0.65	Deg.	Filter = 0, 3mT/mm
			-	0.45		Filter = 0, 3mT/mm, $T_{max}=125^{\circ}C$
XZ - Total Drift ⁽³³⁾	$\partial\theta_{TT_XZ}$	-1.4		1.4	Deg.	Compared to 35°C, 3mT/mm
Hysteresis				0.25	Deg.	3mT/mm

Table 30 - Linear stray-field immune limited magnetic performances

9.5. Standard/Legacy Mode (-300 code)

9.5.1. Nominal Performances

Valid before EoL calibration and for all applications under nominal conditions described in section 8.4 (fig. 10) and chapter 6.

Parameter	Symbol	Min	Typ	Max	Unit	Condition
XY - Intrinsic Linearity Error	L_{E_XY}	-1		1	Deg.	
XZ - Intrinsic Linearity Error	L_{E_XZ}	-2.5	± 1.25	2.5	Deg.	
YZ - Intrinsic Linearity Error	L_{E_YZ}	-2.5	± 1.25	2.5	Deg.	
Noise ⁽³⁵⁾			0.05	0.1		Filter = 0, 40mT
			0.1	0.2	Deg.	Filter = 0, 20mT
			0.05	0.1		Filter = 2
XY - Total Drift ⁽³⁶⁾	$\partial\theta_{TT_XY}$	-0.45		0.45	Deg.	Relative to 35°C
XZ - Total Drift ⁽³⁶⁾	$\partial\theta_{TT_XZ}$	-0.6		0.6	Deg.	Relative to 35°C
YZ - Total Drift ⁽³⁶⁾	$\partial\theta_{TT_YZ}$	-0.6		0.6	Deg.	Relative to 35°C
Hysteresis			0.05	0.1	Deg.	20mT

Table 31 - Standard Mode Nominal Magnetic Performances

³⁵ $\pm 3\sigma$

³⁶ Verification done on new and aged devices in an ideal magnetic field (see 9.1.2). An additional application-specific error arises from the non-ideal magnet and mechanical tolerance drift.

9.5.2. Limited Performances

Valid before EoL calibration and for all applications under limited performances conditions described in section 8.4 (fig. 10) and chapter 6.

Parameter	Symbol	Min	Typ	Max	Unit	Condition
XY - Intrinsic Linearity Error	L_{E_XY}	-1		1	Deg.	
XZ - Intrinsic Linearity Error	L_{E_XZ}	-2.5	± 1.25	2.5	Deg.	
YZ - Intrinsic Linearity Error	L_{E_YZ}	-2.5	± 1.25	2.5	Deg.	
Noise ⁽³⁵⁾			0.2	0.4		Filter = 0
			0.14	0.28	Deg.	Filter = 1
			0.1	0.2		Filter = 2
XY - Total Drift ⁽³⁶⁾	$\partial\theta_{TT_XY}$	-0.6		0.6	Deg.	Relative to 35°C
XZ - Total Drift ⁽³⁶⁾	$\partial\theta_{TT_XZ}$	-0.8		0.8	Deg.	Relative to 35°C
YZ - Total Drift ⁽³⁶⁾	$\partial\theta_{TT_YZ}$	-0.8		0.8	Deg.	Relative to 35°C
Hysteresis			0.1	0.2	Deg.	10mT

Table 32 - Standard Mode Limited Magnetic Performances

10. Memory Specifications

Parameter	Symbol	Min	Typ	Max	Unit	Note
ROM	ROMsize		32		kB	1 bit parity check (single error detection)
RAM	RAMsize		1024		B	1 bit parity check (single error detection)
NVRAM	NVRAMsize		256		B	6 bits ECC (single error correction, double error detection)

Table 33 - Memory Specifications

11. Digital Output Protocol

11.1. Single Edge Nibble Transmission (SENT) SAE J2716

The MLX90372 provides a digital output signal compliant with SAE J2716 Revised APR2016.

11.1.1. Sensor message definition

The MLX90372 repeatedly transmits a sequence of pulses, corresponding with a sequence of nibbles (4 bits), with the following sequence:

- Calibration/Synchronization pulse period 56 clock ticks to determine the time base of the SENT frame
- One 4 bit Status and Serial Communication nibble pulse
- A sequence of one up to six 4 bits data nibbles pulses representing the values of the signal(s) to be transmitted. The number of nibbles will be fixed for each application of the encoding scheme (i.e. Singe Secure sensor format A.3, Throttle positions sensor A.1)
- One 4 bits Checksum nibble pulse
- One optional pause pulse

See also SAE J2716 APR2016 for general SENT specification.



fig. 12 - SENT message encoding example for two 12bits signals

11.1.2. Sensor message frame contents

The MLX90372 SENT transmits a sequence of data nibbles, according to the following configurations:

Description	Symbol	Min	Typ	Max	Unit	Description
SENT	SENTrev		2010	2016		SENT revision. Supports enhanced serial channel messages (2016)
Clock tick time	tickTime	1	3	12	μs	Main use cases : Fast SENT, 1.5μs tick time Normal SENT, 3μs tick time Slow SENT, 6μs tick time (see section 7.4)
Number of data nibbles	Xdn	3	6			
Frame duration (no pause pulse)	Npp	154		270	ticks	6 data nibbles
Frame duration with pause pulse	Ppc	282	320	922	ticks	Valid for 3μs tick time
Sensor type	A.1 A.3					Dual Throttle Position sensors Single Secure sensors

Table 34 - SENT Protocol Frame Definition

11.1.3. Single secure sensor A.3

The MLX90372 SENT transmits a sequence of data nibbles; according single secure sensor format defined in SAE J2716 appendix A.3. The frame contains 12 bit angular value, a 8 bit rolling counter and an inverted copy of the most significant nibble of angular value.

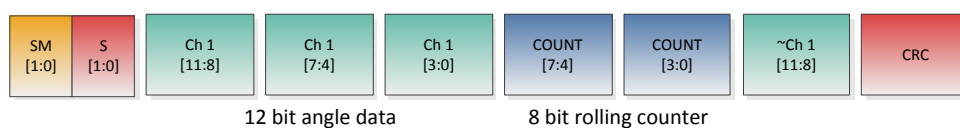

fig. 13 - A.3 Single Secure Sensor Frame Format

Shorthand Description	Tick time	Data nibbles	Pause Pulse	Serial message	Data format
SENT2010-03.0us-6dn-ppc(366.0)-esp-A.3	3μs	6	Y	Enhanced	A.3
SENT2010-03.0us-6dn-ppc(366.0)-nsp-A.3	3μs	6	Y	None	A.3
SENT2010-03.0us-6dn-npp-nsp-A.3	3μs	6	N	None	A.3
SENT2010-##-#us-#dn-###()-###-A.3	1..12	6	Y/N	En/None	A.3

Table 35 - A.3 Single Secure Sensor Shorthand examples

11.1.4. Dual Throttle position sensor A.1

The MLX90372 SENT transmits a sequence of data nibbles; according dual throttle positions sensor defined in SAE J2716 appendix A.1. The frame contains two 12 bit angular values.



fig. 14 - A.1 Dual Throttle Position Sensor Frame Format

Shorthand Description	Tick time	Data nibbles	Pause Pulse	Serial message	Data format
SENT2010-03.0us-6dn-ppc(366.0)-esp-A.1	3µs	6	Y	Enhanced	A.1
SENT2010-03.0us-6dn-ppc(366.0)-nsp-A.1	3µs	6	Y	None	A.1
SENT2010-03.0us-6dn-npp-nsp-A.1	3µs	6	N	None	A.1
SENT2010-##-#us-#dn-###()-###-A.1	1..12	6	Y/N	En/None	A.1

Table 36 - A.1 Dual Throttle Position Sensor Shorthand Examples

Second fast channel configuration:

SENT_FAST_CHANNEL	CH2 configuration
0	Temperature sensor (SP ID 0x23)
1	0xFF9(d4089) - CH1
2	RAM data (RAMPROBE_PTR)
3	0xFFF(d4095) - CH1

Table 37 - A.1 Dual Throttle Position Sensor Fast Channel 2 configuration

11.1.5. Start-up behaviour

The circuit will start to send initialisation frames once digital start-up is done but angle measurement initialisation sequence is not yet complete. These initialisation frames content can be chosen by user with the following option:

SENT_INIT_GM	Initialisation frame value	Comments
0	0x000	SAE compliant
1	0xFF	OEM requirement

Table 38 - Initialisation Frame Content Definition

11.1.6. SENT Output Timing configuration

SENT_TICK_TIME	Tick time configuration	Description
0	3 μ s	Standard SENT
1	0.5 μ s	Not recommended
2	1 μ s	Not recommended
3	1.5 μ s	Fast SENT
4	2.0 μ s	Not recommended
5	2.5 μ s	Not recommended
6	6 μ s	Slow SENT
7	12 μ s	Not recommended

Table 39 - SENT Tick Time Configuration

SENT_SEL_SR_FALL ⁽³⁷⁾	Fall time (T_{fall})	SENT_SEL_SR_RISE ⁽³⁷⁾	Rise Time (T_{rise})
0	No slew rate control	0	No slew rate control
1	0.7 μ s	1	0.9 μ s
2	1.2 μ s	2	1.6 μ s
3	1.9 μ s (ACC) 2.4 μ s (ACE/ADE)	3	3.0 μ s
4	4.8 μ s	4	6.2 μ s
5	9.6 μ s	5	12 μ s
6	19 μ s	6	24 μ s
7	24 μ s	7	30 μ s

Table 40 - SENT Rise and Fall Times Configuration



fig. 15 - SENT Rise and Fall Times configuration

³⁷ Due to output filtering, fast edges on the MLX90372 ADE version cannot be achieved. Use default programmed values.

NIBBLE_PULSE_CONFIG	High/low time configuration
2	Fixed low time (5 ticks)
3	Fixed high time (6 ticks) ⁽³⁸⁾

Table 41 - SENT Nibble configuration (high/low times)

11.1.7. Serial message channel (slow channel)

Serial data is transmitted serial in bit number 3 and 2 of the status and communication nibble. A serial message frame stretches over 18 consecutive SENT data messages from the transmitter. All 18 frames must be successfully received (no errors, calibration pulse variation, data nibble CRC error, etc.) for the serial value to be received.

Enhanced format with 12-bits data and 8-bits message ID is used (SAE J2716 APR2016 5.2.4.2, fig. 5.2.4.2-2). According to the standard, SM[0] contains a 6bits CRC followed by a 12-bits data. Message content is defined by a 8-bit message ID transmitted in the SM[1] channel. Correspondence between ID and message content is defined in the tables below (Table 42, Table 43 and Table 44).

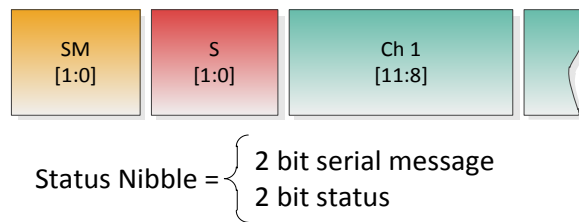

fig. 16 - SENT Status Nibble and Serial Message

By default, the short sequence consisting of a cycle of 24 data is transmitted (Table 42). An extended sequence can be used through configuration of SENT_SLOW_EXTENDED (Table 43). Additionally, the norm of the B field detected by the sensor can be returned at the end of the sequence by setting SENT_SLOW_BFIELD (Table 44)

#	8bit ID	Item	Source data
1	0x01	Diagnostic error code	Current status code from RAM
2	0x06	SENT standard revision	SENT_REV from NVRAM
3	0x01	Diagnostic error code	Current status code from RAM
4	0x05	Manufacturer code	SENT_MAN_CODE from NVRAM
5	0x01	Diagnostic error code	Current status code from RAM

³⁸ When using fixed high time in normal SENT mode, Melexis recommends lowering SENT_SEL_SR_RISE to 3 or setting ABE_OUT_MODE to 2 to two to avoid potential timing degradation on short nibbles.

#	8bit ID	Item	Source data
6	0x03	Channel 1 / 2 Sensor type	SENT_SENSOR_TYPE from NVRAM
7	0x01	Diagnostic error code	Current status code from RAM
8	0x07	Fast channel 1: X1	SENT_CHANNEL_X1 from NVRAM
9	0x01	Diagnostic error code	Current status code from RAM
10	0x08	Fast channel 1: X2	SENT_CHANNEL_X2 from NVRAM
11	0x01	Diagnostic error code	Current status code from RAM
12	0x09	Fast channel 1: Y1	SENT_CHANNEL_Y1 from NVRAM
13	0x01	Diagnostic error code	Current status code from RAM
14	0x0A	Fast channel 1: Y2	SENT_CHANNEL_Y2 from NVRAM
15	0x01	Diagnostic error code	Current status code from RAM
16	0x23	(Internal) temperature	Current temperature from RAM
17	0x01	Diagnostic error code	Current status code from RAM
18	0x29	Sensor ID #1	SENT_SENSOR_ID1 from NVRAM
19	0x01	Diagnostic error code	Current status code from RAM
20	0x2A	Sensor ID #2	SENT_SENSOR_ID2 from NVRAM
21	0x01	Diagnostic error code	Current status code from RAM
22	0x2B	Sensor ID #3	SENT_SENSOR_ID3 from NVRAM
23	0x01	Diagnostic error code	Current status code from RAM
24	0x2C	Sensor ID #4	SENT_SENSOR_ID4 from NVRAM

Table 42 - SENT Slow Channel Standard Data Sequence

#	8bit ID	Item	Source data
25	0x01	Diagnostic error code	Current status code from RAM
26	0x90	OEM Code #1	SENT_OEM_CODE1 from NVRAM
27	0x01	Diagnostic error code	Current status code from RAM
28	0x91	OEM Code #2	SENT_OEM_CODE2 from NVRAM
29	0x01	Diagnostic error code	Current status code from RAM
30	0x92	OEM Code #3	SENT_OEM_CODE3 from NVRAM
31	0x01	Diagnostic error code	Current status code from RAM
32	0x93	OEM Code #4	SENT_OEM_CODE4 from NVRAM
33	0x01	Diagnostic error code	Current status code from RAM
34	0x94	OEM Code #5	SENT_OEM_CODE5 from NVRAM
35	0x01	Diagnostic error code	Current status code from RAM
36	0x95	OEM Code #6	SENT_OEM_CODE6 from NVRAM

#	8bit ID	Item	Source data
37	0x01	Diagnostic error code	Current status code from RAM
38	0x96	OEM Code #7	SENT_OEM_CODE7 from NVRAM
39	0x01	Diagnostic error code	Current status code from RAM
40	0x97	OEM Code #8	SENT_OEM_CODE8 from NVRAM

Table 43 - SENT Slow Channel Extended Data Sequence

#	8bit ID	Item	source data
25	0x80	Field Strength	Bfield_norm from RAM (standard sequence)
41	0x80	Field Strength	Bfield_norm from RAM (extended sequence)

Table 44 - SENT Slow Channel Magnetic Field Norm ID and position

For Field Strength encoding, see chapter 8, Magnetic Field Specifications, under the application corresponding section.

11.1.8. Serial Message Error Code

The list of error and status messages transmitted in the 12-bit Serial Message data field when Serial Message 8-bit ID is 0x01, is given in the Table 45. The error is one-hot encoded and therefore each bit is linked to one or several monitor. Only the first error detected is reported and serial message error code will not be updated until all the errors have disappeared. This mechanism ensures only one error at a time takes control of the error debouncing counter (see 13.5.2).

The MSB acts as an error Flag when SENT_DIAG_STRICT is set. This bit will be high only when an error is present. For compatibility with previous Triaxis®, this bit can be kept high even if no error is present (SENT_DIAG_STRICT = 0).

Bit Nb	12 Bit Data (hex)	Diagnostic	Comments
-	0x000 / 0x800	No error	Programmable (SENT_DIAG_STRICT, see Table 49, no 138)
0	0x801	GainOOS	Gain out of spec (see 13.3.2, GAIN_MIN, GAIN_MAX)
1	0x802	FieldTooLow	Fieldstrength is below defined low threshold (see Table 49)
2	0x804	FieldTooHigh	Fieldstrength is above defined high threshold (see Table 49)

Bit Nb	12 Bit Data (hex)	Diagnostic	Comments
3	0x808	ADCclip	ADC is saturated, either low or high
4	0x810	ADC_test	ADC made wrong conversion
5	0x820	Analog Supply Monitors	Detects VDDA (VDEC) over and under voltage or VDD under voltage
6	0x840	Digital Supply Monitors	Detects VDDD (1.8V internal digital supply) overvoltage
7	0x880	RoughOffset	Hall Element offset monitor
8	0x900	Over/Under Temp	Temperature sensor monitor (see 13.5.3)
9	0xA00	HE_Bias / Analog Front End	Hall Element biasing issue / Analog front end self-test ⁽³⁹⁾
10	0xC00	Suply Bias Current	Current biasing system monitor
11	0x800	Extra Error Flag	set to one if any error present (only when SENT_DIAG_STRICT = 1). Otherwise, always high.

Table 45 - SENT Serial Message Error Code

11.1.9. SENT configuration shorthand definition

Shorthand description	Format	Req	90372 programmable setting
SENT SAE J2716 Rev	SENT xxxx	2007	CRC_2007
		2008	0 > 2007
		2010	1 2007
		2016	
Clock Tick length [μs]	XX.X μs	0.5<xx<12	SENT_TICK_TIME
			0 SENT 3.0μs
			1 SENT 0.5μs
			2 SENT 1μs
			3 SENT 1.5μs
			4 SENT 2.0μs
			5 SENT 2.5μs
			6 SENT 6.0μs
7 SENT 12.0μs			
Number of data Nibbles	X dn	3 ≤ x ≤ 6	EN_FAST_CH2
			0 3 Data nibbles
			1 6 Data nibbles

³⁹ Only available on MLX90372 ACE and ADE version (not on ACC)

Shorthand description	Format	Req	90372 programmable setting
Pause Pulse Option	npp	No pause Pulse	PROTOCOL 0 = npp
	ppc (xxx.0)	Pause Pulse with const. frame length	2 = ppc
	xxx	Frame Length (in clock ticks)	T_FRAME xxx > 282...922
Use of Serial protocol	nsp	No serial protocol	SERIAL_CONFIG 1 nsp
	ssp	Short serial protocol	2 ssp (not compliant)
	esp	Enhanced serial protocol	3 esp
Sensor type	A.1	Dual Throttle Position sensor	SENT_SS 0 A.1
	A.3	Single secure sensor	1 A.3

Table 46 - SENT Shorthand Description

11.2. PWM (pulse width modulation)

11.2.1. Definition



fig. 17 - PWM Signal definition

Parameter	Symbol	Test Conditions
PWM period	T_{PWM}	Trigger level = 50% V_{DD}
Jitter	J_{ON} J_{PWM}	$\pm 3\sigma$ for 1000 successive acquisitions with clamped output
Duty Cycle	DC	$T_{\text{ON}} / T_{\text{PWM}}$

Table 47 - PWM Signal definition

11.2.2. PWM performances

Parameter	Symbol	Min	Typ	Max	Unit	Condition
PWM Output Resolution	R_{PWM}		0.024	0.051	%DC/LSB	2kHz. Worst case error for 160°C
PWM %DC Jitter	J_{DC}			0.03	%DC	Push-Pull, 2kHz, $C_{\text{L}}=4.7\text{nF}$, $R_{\text{LPU}}=4.7\text{k}\Omega$
PWM Period Jitter	J_{PWM}	-	-	300	ns	Push-Pull, 2kHz, $C_{\text{L}}=4.7\text{nF}$, $R_{\text{LPU}}=4.7\text{k}\Omega$
PWM %DC thermal drift			0.02	0.05	%DC	Push-Pull, 2kHz, $C_{\text{L}}=4.7\text{nF}$, $R_{\text{LPU}}=4.7\text{k}\Omega$

Table 48 - PWM Signal Specifications

12. End-User Programmable Items

Parameter	PSF value	Description	Default Values	
			Standard	#bits
GENERAL CONFIGURATION				
USER_ID[0..5]	1..6	User Id. Reference. Reserved for customer traceability	see 12.1	6 x 8
MEMLOCK	163	Disable NVRAM write (memory LOCK)	0	2
WARM_ACT_HIGHV	223	Enable battery application ($V_{DD} > 5\text{ V}$)	0	1
WARM_TRIGGER_LONG	156	Add delay to enter PTC mode (MT7V)	0	1
SENSOR FRONT-END				
MAGNET_SREL_T[1..7]	179, 8..13	Magnet Relative sensitivity at temperature Tx. This parameter is mainly used in Linear Hall Mode. It is advised to keep defaults for other modes.	255	8
GAINMIN	14	Low threshold for virtual gain	01	8
GAINMAX	15	High threshold for virtual gain	63	8
GAINSATURATION	26	Gain Saturates on GAINMIX and GAINMAX	0	1
SENSING_MODE	18	Mapping fields for output angle		
		Rotary stray field Immune -- order code 100/500	0	3
		Linear position stray field Immune -- order code 200	4	
Linear position / Angular Rotary -- order code 300	1-3			
DSP_NB_CONV ⁽⁴⁰⁾	19	Number of phase spinning within ADC sequence 0=4 phase spinning	0 ⁽⁴⁰⁾	2
DSP - FILTERING				
FILTER	21	Filter mode selection	1	2
HYST	16	Hysteresis threshold for EMA filter	0	8
DENOISING_FILTER_ALPHA_SEL	79	Select the alpha parameter of the EMA (IIR) filter	0	2
DSP – ANGLE MAPPING FUNCTIONS				
CW	20	Set rotation to clockwise	0	1
DP	27	Discontinuity point	0	16
WORK_RANGE_GAIN	217	Re-scaling before the piece-wise linearization step	16	8
WORKING_RANGE	23	17, 32pts - Output angle range (= limited selection of WORK_RANGE_GAIN)	0	3
4POINTS	22	Select LNR method 4 pts	0	1
DSP_LNR_RESX2	78	Enable a double resolution LNR method 0: 4-points or 16-segments 1: 8-points or 32-segments	0	1
GAIN_ANCHOR_MID	180	re-scaling before the piece-wise linearization step	1	1

⁴⁰ Changing default value could impact the safety metrics. Default value shall be used.

Parameter	PSF value	Description	Default Values	
			Standard	#bits
LNR50, LNRAS.. LNRDS	29,35 41,48, 57	4pts –Slope for reference points A,B,C,D	N/A	16
LNRAX, LNRBX.. LNRDX	31,37, 43,51	4pts - X Coordinate for reference points A,B,C,D	N/A	16
LNRAY, LNRBY.. LNRDY	33,39, 45,54	4pts - Y Coordinate for reference points A,B,C,D	N/A	16
LNRX0..X7	46..65	8 pts - X coordinate point 0..7	N/A	16
LNRY0..Y16	28..69	17 pts - Y coordinate point 0..16	1-4088	16
LNR_DELTA_Y01..Y32	182.. 213	Delta Y for 32-segment linearization	N/A	8
LNR_DELTA_Y_EXPAND_LOG2	216	Adjust the span of NV_LNR_DELTA_Yn	0	2
USEROPTION_SCALING	24	Enables the output scaling function (x2) 0 = [0..100%] 1 = [-50..150%]	1	1
CLAMPLOW	71	Low clamping value of angle data	1	12
CLAMPHIGH	72	High clamping value of angle data	4088	12
OUTSLOPE_SEL ⁽⁴¹⁾	246	Select temperature-dependent offset (see 13.2.10)	0	2
OUTSLOPE_COLD ⁽⁴¹⁾	253	Slope coefficient at cold of the programmable temperature-dependent offset (signed value)	0	8
OUTSLOPE_HOT ⁽⁴¹⁾	254	Slope coefficient at Hot of the programmable temperature-dependent offset (signed value)	0	8

DIAGNOSTICS

DIAG_TEMP_THR_LOW ⁽⁴⁰⁾	84	Temperature threshold for under-temperature diagnostic	8 ⁽⁴⁰⁾	8
DIAG_TEMP_THR_HIGH ⁽⁴⁰⁾	85	Temperature threshold for over-temperature diagnostic	136 ⁽⁴⁰⁾	8
DIAG_FIELDTOOLOWTHRES	86	Field limit under which a fault is reported. On revision ACC, need to be programmed by user to be active. Each LSB of this threshold corresponds to 4 LSB of the field strength.	(42)	8
DIAG_FIELDTOOHIGHTHRES	87	Field limit over which a fault is reported. Each LSB of this threshold corresponds to 4 LSB of the field strength.	255	8
PWM WEAKMAGTHRESH	88	Weak Magnet threshold Byte (PWM only)	0	8
DIAGDEBOUNCE_STEPDOWN	90	Diagnostic debouncing stepdown time	1	4
DIAGDEBOUNCE_STEPUP	91	Diagnostic debouncing step-up time	2	4
DIAGDEBOUNCE_THRESH	93	Diagnostic debouncing threshold	2	6

⁴¹ Only available on IC revisions ACE and ADE

⁴² Default value depends on application and IC revision. See chapter 8 tables for more information.

Parameter	PSF value	Description	Default Values	
			Standard	#bits
DIAG_EN ⁽⁴⁰⁾	94	Diagnostics global enable. Do not modify! (see 14.2 Safety Mechanisms)	1 ⁽⁴⁰⁾	1
COLD_SAFE_STARTUP_EN	95	Normal (0) or full safe (1) start-up after power-on reset (see 7.3.1)	0	1
OUT_DIAG_HIZ_TIME	161	Duration of output High-Z after transient digital fault, do not modify!	-	3

OUTPUT CONFIGURATION

PROTOCOL	100	Select digital output communication mode	2	2
		0 = SENT without pause pulse		
		1 = PWM		
		2 = SENT with pause (default)		
TWO_ANGLES_FRAME	125	Enable 2 angle measurements SENT period w/ pause pulse. ! Has impact on the analog diagnostics DCT (see Table 12 - General Timing Specifications)	1	1
NIBBLE_PULSE_CONFIG	220	SENT nibble high/low-time configuration	2	2
		2 = Fixed 5 ticks low		
		3 = Fixed 6 ticks high		
T_FRAME	134	SENT Frame Tick Count / PWM period (4µs/LSB). ! Has impact on the analog diagnostics DCT (see Table 12 - General Timing Specifications)	320 ⁽⁴³⁾	12
T_SYNC_DELAY ⁽⁴⁰⁾	137	SENT - ADC synchronization delay	69 ⁽⁴³⁾	12
ABE_OUT_MODE	157	Output mode in normal mode	0	2
		00: SENT mode, digital push-pull		
		01: SENT mode, open-drain		
		10: PWM mode, digital fast push-pull		
		11: PWM open-drain, increased short circuit current		
SENT_SEL_SR_FALL	530	SENT slope Fall time configuration (see Table 40)	4	3
SENT_SEL_SR_RISE	531	SENT slope Rise time configuration (see Table 40)	4	3
ABE_OUT_CFG	159	Output pin configuration, do not modify!	6	2
OUT_ALWAYS_HIGHZ	105	Forces the PWM second output (TEST pin) in high-Z mode	0	1
PWM PROTOCOL OPTIONS				
PWM_POL	102	Invert the PWM polarity	0	1
PWM_REPORT_MODE_ANA	104	Error message within PWM frame	N/A	2
		0x0: PWM - config 2 (PWM signal in fault band)		
		0x1: PWM - config 1 (HiZ)		
		0x2: Output = config 3.a (0 constant)		
		0x3: Output = config 3.b (1 constant)		

⁴³ Default value is valid for ACE/ADE. ACC chip revision comes with T_FRAME=366 and T_SYNC_DELAY=21 as default value. Both T_FRAME and T_SYNC_DELAY have impact on safety metrics and shall follow Melexis programming recommendations.

Parameter	PSF value	Description	Default Values	
			Standard	#bits
PWM_DC_FAULT	107	PWM Duty Cycle in case of Fault	4	8
PWM_DC_FIELDTOOLOW	108	PWM Duty Cycle in case of Field Strength Too Low	10	8
PWM_DC_WEAKMAG	109	PWM Duty Cycle in case of Weak Magnet	6	8
SENT PROTOCOL OPTIONS				
STATUS_IN_CRC	111	Add first nibble in SENT CRC calculation	0	1
EN_FAST_CH2	113	Enable serial message DATA nibbles [6:4]	1	1
SENT_CH1_SRC_SEL ⁽⁴⁰⁾	114	Selection of the SENT channel 1 source: 0: Angle 1: RAM data at addr SENT_CH2_PTR	0 ⁽⁴⁰⁾	1
RAMPROBE_PTR	116	Data to be transmitted in SENT channel 2	N/A	16
SENT_MAN_CODE	118	Serial data message Manufacturer code	6	12
SENT_REV	119	Serial data message SENT rev	4	12
SENT_SENSOR_TYPE	121	Serial data message SENSOR_TYPE	0x050	12
SENT_TICK_TIME ⁽⁴⁰⁾	123	Sent tick time	0 ⁽⁴⁰⁾	3
SENT_SS	124	Enable Single Secure sensor format A.3	1	1
SENT_SLOW_EXTENDED	126	Enable enhanced serial message ID OEM code 25-40	0	1
SENT_FAST_CHANNEL_2	128	Configuration of SENT fast channel 2 when NV_SENT_SS=0	2	2
SENT_LEGACY_CRC	129	Enable SENT2007 CRC calculation	0	1
SENT_SLOW_BFIELD	130	Enable enhanced serial message ID 80	0	1
SENT_REPORT_MODE_ANA	131	Error message within SENT frame in diagnostic mode: 0x0: SENT - Status bit S0 is set 0x1: SENT - Status bit S0 is set and data = FF9 + DIAG_FAULT_CODE (FFF by default) 0x2: SENT - Status bit S0 is set and the redundant nibble is inverted	0	2
DIAG_FAULT_CODE ⁽⁴¹⁾	645	Defines the fault code when SENT_REPORT_MODE_ANA=1	6	3
SENT_DIAG_STRICT	138	Enhanced serial error reporting option: Disable Bit 11 when no error is present.	1	1
SENT_CHANNEL_X1	139	Serial data message X1	0	12
SENT_CHANNEL_X2	140	Serial data message X2	0	12
SENT_CHANNEL_Y1	141	Serial data message Y1	0	12
SENT_CHANNEL_Y2	142	Serial data message Y2	0	12
SENT_SENSOR_ID1..4	143.. 146	Serial data message sensor ID1.. ID4	0	12
SENT_OEM_CODE1..8	147.. 154	Serial data message OEM code 1..8	0	12

Parameter	PSF value	Description	Default Values	
			Standard	#bits
SERIAL_CONFIG	221	SENT serial configuration 1 = No serial protocol 3 = Enhanced serial protocol Do not use 0, 1 or 2 to retain safety goal.	3	2
SENT_INIT_GM	222	SENT initialization , 0 = transmitting 0 as initialization data 1 = transmitting 4095 as initialization data	0	1

Table 49 - MLX90372 End-User Programmable Items Table

Performances described in this document are only achieved by adequate programming of the device. To ensure desired functionality, Melexis recommends following its programming guidelines and contacting its technical or application services. Melexis does not guarantee the safety of the element if the configuration of the device is done outside of the above defined values and recommendations.

12.1. End User Identification Items

Parameter	PSF value	Description	Default Values	
			Standard	#bits
USER_ID[0..5]	1..6	User Id. References	-	8
USER_ID2	3	Product Number for 90372ACC	4	8
		Product Number for 90372ACE	7	
		Product Number for 90372ADE	8	
USER_ID3	4	NVRAM default user content revision		8
		90372 ACC	8	
		90372 ACE/ADE	9	
IMC_VERSION	692	0 : Rotary Stray Field Robust, low field version (-1xx ordering code) 1 : Angular / Linear position legacy (-3xx ordering code) 2 : Linear Stray Field Robust (-2xx ordering code) 4 : Rotary Stray Field Robust, high field version (-5xx ordering code)	-	7
MLX_ID0	677	X-Y position on the wafer (8 bit each)	-	16
MLX_ID1	680	Wafer ID (5 bits)	-	16
		Lot ID [10..0]		
MLX_ID2	683	Lot ID [16..11]	-	16
		Fab ID (4 bits)		
		Test Database ID (6 bits)		

Table 50 - Melexis and Customer ID fields description

User identification numbers (48 bits, 6 bytes) are freely usable by customers for traceability purpose. Other IDs are read only.

13. Description of End-User Programmable Items

13.1. Output modes

13.1.1. OUT mode (ABE_OUT_MODE)

Defines the Output Stage mode (SENT or PWM, driver mode) in application.

ABE_OUT_MODE	Type	Description	Comments
0	SENT	Push-Pull	
1	SENT	Open Drain	Requires a pull-up resistor
2	PWM	Push-Pull	In PWM mode, edge rising time is similar to falling time.
3	PWM	Open Drain	Requires a pull-up resistor, increased short circuit current (Table 11)

Table 51 - Output Mode Selection

13.1.2. Digital OUT protocol (PROTOCOL)

Selection of the measurement timing mode and the corresponding output protocol

PROTOCOL	Type	Descriptions
0	SENT	Continuous asynchronous angle acquisition, SENT without pause pulse
1	PWM	Continuous asynchronous angle acquisition, PWM
2	SENT	Continuous synchronous angle acquisition, SENT with pause

Table 52 - Protocol Selection

13.1.3. Serial Channel Configuration - Status and Communication Nibble

SERIAL_CONFIG	Type	Descriptions
0	-	Status and Communication nibble is not present. This configuration is not compliant with SENT. Do Not Use!
1	nsp	Status nibble will report an error. Data sent along the serial channel is taken from RAM.
2	ssp	This short serial protocol is not compliant with SENT. Do Not Use!
3	esp	Status nibble reports errors and serial channel reports sequence defined in 11.1.7

Table 53 - SENT Serial channel Configuration

13.1.4. PWM Output Mode

If PWM output mode is selected, the output signal is a digital signal with Pulse Width Modulation (PWM). The PWM polarity is selected by the PWMPOL parameter:

- PWM_POL = 0 for a low level at 100%
- PWM_POL = 1 for a high level at 100%

The PWM frequency is selected in the range [100, 2000] Hz by the T_FRAME parameter (12bits), defining the period time in the range [0.5; 10] ms. Minimum allowed value for T_FRAME is therefore 125 (0x7d).

$$T_{PWM} = \frac{4}{10^6} \times T_{FRAME}$$

- PWM period is derived from the main clock and subject to the same tolerances (see ΔF_{ck}).

13.2. Output Transfer Characteristic

There are 4 different possibilities to define the transfer function (LNR) as specified in the Table 54.

- With 4 arbitrary points (defined by X and Y coordinates) and 5 slopes
- With 8 arbitrary points (defined by X and Y coordinates)
- With 17 equidistant points for which only the Y coordinates are defined
- With 32 equidistant points for which only offset of Y compared to the average value is defined

Output Transfer Characteristic	4POINTS	DSP_LNR_RESX2
4 Arbitrary Points	1	0
8 Arbitrary Points	1	1
17 Equidistant Points	0	0
32 Equidistant Points	0	1

Table 54 - Output Transfer Characteristic Selection Table

Parameter	LNR type	Value	Unit
CW	All	0 → counter clockwise 1 → clockwise	LSB
DP	All	0 ... 359.9999	deg
LNRAX LNRBX LNRCX LNRDX	4 pts, X coordinates	0 ... 359.9999	deg

Parameter	LNR type	Value	Unit
LNRAY LNRBY LNRCY LNRDY	4 pts, Y coordinates	0 ... 100 -50 ... + 150	%
LNRS0 LNRAS LNRBS LNRCS LNRDS	4 pts, slopes	-17 ... 0 ... 17	%/deg
LNRX0 .. LNRX7	8 pts, X coordinates	0 ... 359.9999	deg
LNR Y0 ... LNR Y7 ... LNR Y16	8,17 pts, Y coordinates	0..100 -50 ... + 150	%
LNR_DELTA Y01 ... LNR_DELTA Y32	32 pts offsets	+/-3.125% +/-6.25% +/-12.5% +/-25%	%
WORKING RANGE ⁴⁴	17/32 pts	65.5 ... 360 32.75 ... 180	deg
CLAMP_LOW	All	0 ... 100	%
CLAMP_HIGH	All	0 ... 100	%

Table 55 - Output linearization and clamping parameters

13.2.1. Enable scaling Parameter

This parameter enables to double the scale of Y coordinates linearisation parameters from [0 .. 100]% to [-50 .. 150]% according to the following table (Table 56). This is valid for all linearisation schemes except the 32 points.

USEROPTION_SCALING	LNR_Y min value	LNR_Y max value
0	0%	100%
1	-50%	150%

Table 56 - USEROPTION_SCALING parameter

⁴⁴ See 13.2.8 for details

13.2.2. CW (Clockwise) Parameter

The CW parameter defines the magnet rotation direction.

- 0 or counter clockwise is defined by the 1-4-5-8 pin order direction for the SOIC-8 package and 1-8-9-16 pin order direction for the TSSOP-16 package.
- 1 or clockwise is defined by the reverse direction: 8-5-4-1 pin order direction for the SOIC-8 and 16-9-8-1 pin order direction for the TSSOP-16 package.

Refer to the drawing in the sensitive spot positioning section (18.4, 18.8, 18.16).

13.2.3. Discontinuity Point (or Zero Degree Point)

The Discontinuity Point defines the 0° point on the circle. The discontinuity point places the origin at any location of the trigonometric circle. The DP is used as reference for all the angular measurements.



fig. 18 - Discontinuity Point Positioning

13.2.4. 4-Pts LNR Parameters

The LNR parameters, together with the clamping values, fully define the relation (the transfer function) between the digital angle and the output signal.

The shape of the MLX90372 four points transfer function from the digital angle value to the digital output is described in the following figure (fig. 19). Seven segments can be programmed but the clamping levels are necessarily flat.

Two, three, or even six calibration points are then available, reducing the overall non-linearity of the IC by almost an order of magnitude each time. Three or six calibration point will be preferred by customers looking for excellent non-linearity figures. Two-point calibrations will be preferred by customers looking for a cheaper calibration set-up and shorter calibration time.

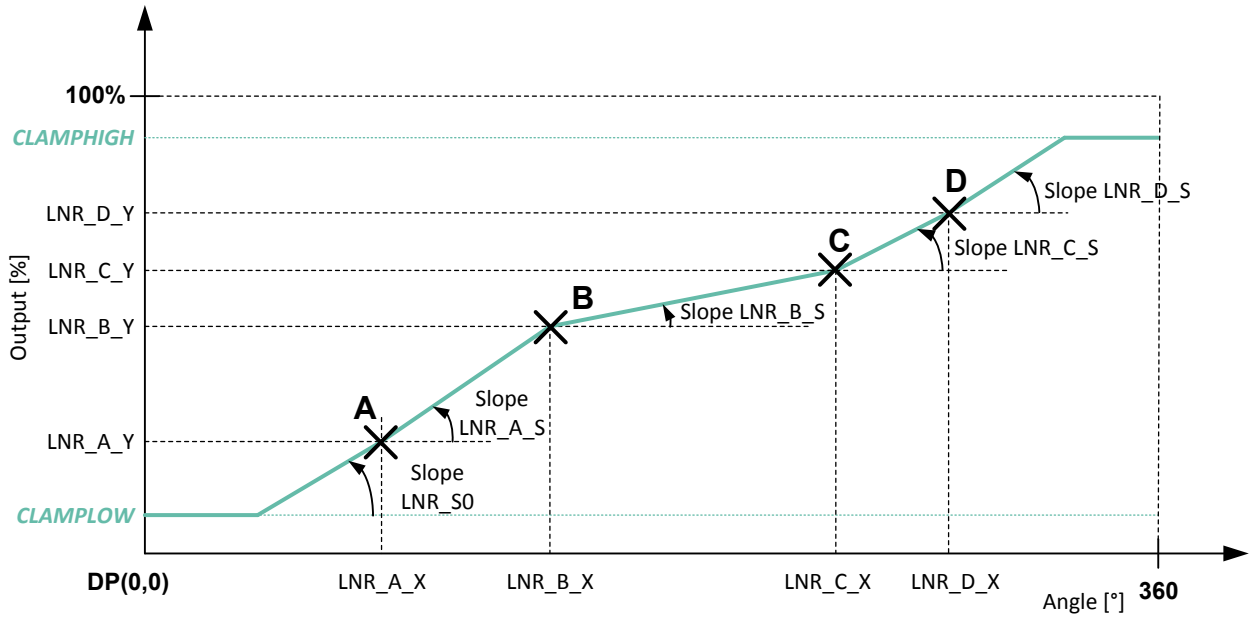

fig. 19 - 4pts Linearisation Parameters Description

13.2.5. 8-Pts LNR Parameters

The 8-Pts LNR parameters, together with the clamping values, fully define the relation (the transfer function) between the digital angle and the output signal.

The shape of the MLX90372 eight points transfer function from the digital angle value to the output voltage is described in the following figure (fig. 20). Eight calibration points [LNR_X0...7, LNR_Y0...7] together with 2 fixed points at the extremity of the range ([0°, 0%] ; [360°, 100%]) divides the transfer curve into 9 segments. Each segment is defined by 2 points and the values in between is calculated by linear interpolation.

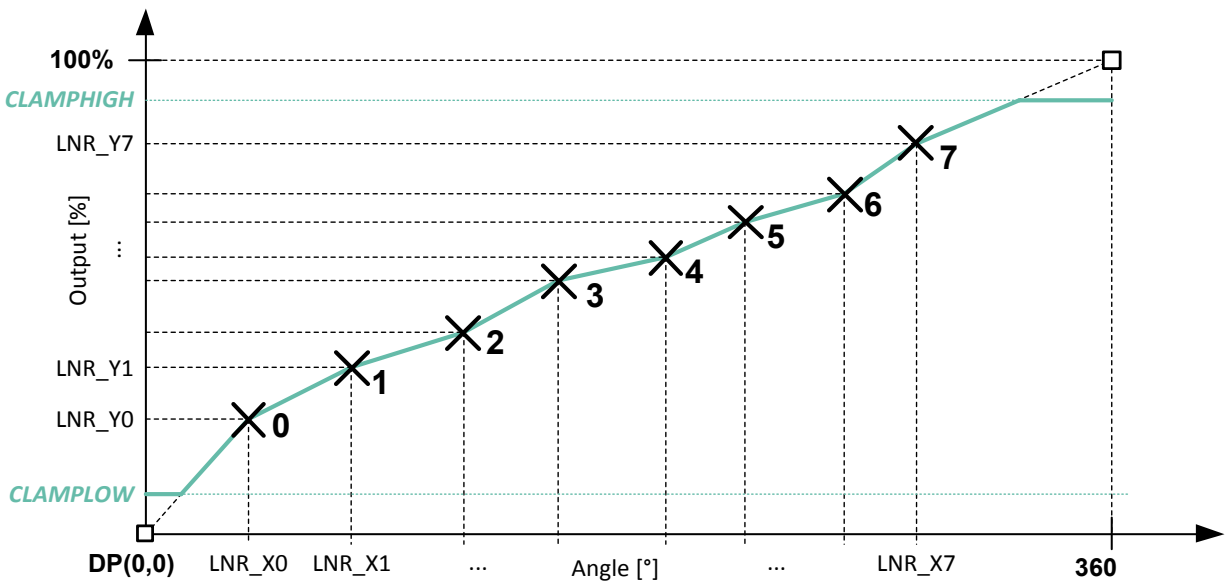

fig. 20 - 8pts Linearisation Parameters Description

13.2.6. 17-Pts LNR Parameters

The LNR parameters, together with the clamping values, fully define the relation (the transfer function) between the digital angle and the output signal.

The shape of the MLX90372 seventeen points transfer function from the digital angle value to the output voltage is described in the following figure (fig. 21). In the 17-Pts mode, the output transfer characteristic is Piece-Wise-Linear (PWL).



fig. 21 - 17pts Linearisation Parameters Description

All the Y-coordinates can be programmed from -50% up to +150% to allow clamping in the middle of one segment (like on the figure), but the output value is limited to CLAMPLOW and CLAMPHIGH values.

Between two consecutive points, the output characteristic is interpolated.

13.2.7. 32-Pts LNR parameters

The LNR parameters, together with the clamping values, fully define the relation (the transfer function) between the digital angle and the output signal.

The shape of the MLX90372 thirty-two points transfer function from the digital angle value to the output voltage is described in the following figure (fig. 22). In the 32-Pts mode, the output transfer characteristic is Piece-Wise-Linear (PWL).

The points are spread evenly across the working range (see. 13.2.8 and 13.2.9 for working range selection). The Y-coordinates can be offset from the ideal characteristic within an adjustable range defined by LNR_DELTA_Y_EXPAND_LOG2. The available values are summarized in Table 57. All LNR_delta_Y## parameters are encoded in a fractional signed 8-bit value.



fig. 22 - 32pts Linearisation Parameters Description

LNR_DELTA_Y_EXP AND_LOG2	Adjustable Range	Correction resolution
0	±3.125%	0.024%
1	±6.25%	0.049%
2	±12.5%	0.098%
3	±25%	0.20%

Table 57 - LRN_DELTA_Y_EXPAND_LOG2 values and correction resolution

13.2.8. WORKING_RANGE Parameter for Angle Range Selection

The parameter WORKING_RANGE determines the input range on which the 16 or 32 segments are uniformly spread. This parameter is provided for compatibility with former versions of MLX Triaxis sensors. For full featured working range selection, see 13.2.9. For WORKING_RANGE parameter (W), following table applies.

W	Range	Δx 17pts	Δx 32pts
0	180.0°	11.3°	5.6°
1	160.0°	10.0°	5.0°
2	144.0°	9.0°	4.5°
3	131°	8.2°	4.1°
4	120.0°	7.5°	3.8°
5	221.5°	6.9°	3.5°
6	103°	6.4°	3.2°
7	96°	6.0°	3.0°

W	Range	Δx 17pts	Δx 32pts
8	90.0°	5.6°	2.8°
9	72.0°	4.5°	2.3°
10	60.0°	3.8°	1.9°
11	51.45°	3.2°	1.6°
12	45.0°	2.8°	1.4°
13	40.0°	2.5°	1.3°
14	36.0°	2.3°	1.1°
15	32.75°	2.0°	1.0°

Table 58 - Working range for 180° periodicity (order code -100, -500)

W	Range	Δx 17pts	Δx 32pts	W	Range	Δx 17pts	Δx 32pts
0	360.0°	22.5°	11.3°	8	180.0°	11.3°	5.6°
1	320.0°	20.0°	10.0°	9	144.0°	9.0°	4.5°
2	288.0°	18.0°	9.0°	10	120.0°	7.5°	3.8°
3	261.8°	16.4°	8.2°	11	102.9°	6.4°	3.2°
4	240.0°	15.0°	7.5°	12	90.0°	5.6°	2.8°
5	221.5°	13.8°	6.9°	13	80.0°	5.0°	2.5°
6	205.7°	12.9°	6.4°	14	72.0°	4.5°	2.3°
7	192.0°	12.0°	6.0°	15	65.5°	4.1°	2.0°

Table 59 - Working range for 360° periodicity (order code -200, -300)

Outside of the selected range, the output will remain at clamping levels.

13.2.9. WORK_RANGE_GAIN Parameter for Angle Range Selection

Alternatively, the range for the angle can be selected using the WORK_RANGE_GAIN parameter, which applies a fixed gain to the transfer characteristic. When using WORK_RANGE_GAIN parameter, the anchor point is set in the middle of the full angular range, MaxRange/2, and the valid range is set symmetrically around this value based on the parameter value.

WORK_RANGE_GAIN is coded on 8 bits where the 4 MSB defines the integer part and the 4 LSB the fractional part. Therefore, the following equation applies to define the angle range w:

$$w = \frac{16 * \text{MaxRange}}{\text{WORK_RANGE_GAIN}}$$

MaxRange depends on the application. It is 360° for ordering codes -200 and -300 (linear stray-field immune and legacy) and 180° for ordering codes -100 and -500 (rotary stray-field immune). Both minimal and maximal angles are then defined by :

$$\theta_{min} = \frac{\text{MaxRange} - w}{2} ; \theta_{max} = \frac{\text{MaxRange} + w}{2}$$

where θ_{min} corresponds to the angle yielding 0% output and θ_{max} the angle giving a 100% output. Following tables give some values as example

WORK_RANGE_GAIN	Zoom Factor	Range (w)	θ_{min}	θ_{max}	Δx 17pts	Δx 32pts
0x10	1	180°	0°	180°	11.25°	5.63°
0x20	2	90°	45°	135°	5.63°	2.81°
0x40	4	45°	67.5°	112.5°	2.81°	1.41°
0xFF	15.94	11.3°	78.7°	101.3°	0.71°	0.35°

Table 60 - Working range defined by WORK_RANGE_GAIN parameter (ordering codes -100, -500)

WORK_RANGE_GAIN	Zoom Factor	Range (w)	θ_{min}	θ_{max}	Δx 17pts	Δx 32pts
0x10	1	360°	0°	360°	22.5°	11.3°
0x20	2	180°	90°	270°	11.3°	5.6°
0x40	4	90°	135°	225°	5.6°	2.8°
0xFF	15.94	22.6°	168.7°	191.3°	1.41°	0.71°

Table 61 - Working range defined by WORK_RANGE_GAIN parameter (ordering codes -200, -300)

Outside of the working range, the output will remain at clamping levels.

13.2.10. Thermal OUTSLOPE offset correction

Two parameters, OUTSLOPEHOT and OUTSLOPECOLD, are used to add a temperature dependent offset. This feature is enabled by the parameter OUTSLOPE_SEL that apply this modification either directly to the angle or after the linearisation function. This thermal offset is only available with the revisions ACE or ADE of the MLX90372. The MLX90372 uses its internal linearized temperature to compute the offset shift as depicted in the figure below (fig. 23)

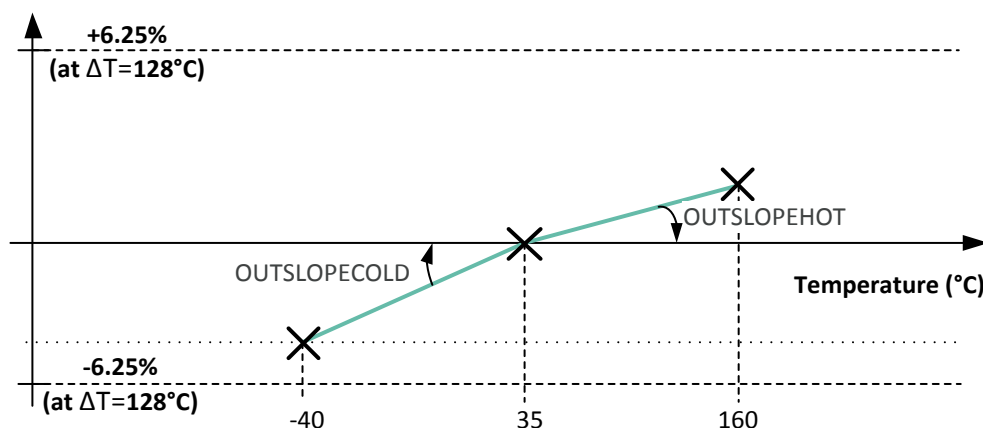

fig. 23 - Temperature compensated offset

The thermal offset can be added or subtracted before the clamping, either to the angle or output. The span of this offset is $\pm 6.25\%$ of the full output scale for a temperature difference of 128°C . The added thermal offset varies with temperature following the equations below. The two thermal coefficients are encoded in signed two's complement 8bit format (-128..127) and defined separately below 35°C (OUTSLOPECOLD) and above 35°C (OUTSLOPEHOT).

OUTSLOPE_SEL	Description
0	No thermal offset correction
1	Thermal offset enabled, applied after angle calculation, i.e. after discontinuity point (θ_{r2p})
2	Enabled, applied after output calculation and before clamping (θ_{out})

Table 62 - Temperature compensated offset selection parameter

If IC internal temperature is higher than 35°C then:

$$\theta_{Tcomp} = \theta_{in}(1 - \Delta T \cdot \text{OUTSLOPEHOT})$$

If IC internal temperature is lower than 35°C then:

$$\theta_{Tcomp} = \theta_{in}(1 - \Delta T \cdot \text{OUTSLOPECOLD})$$

where θ_{in} is either θ_{r2p} or θ_{out} depending on OUSLOPE_SEL value.

13.2.11. CLAMPING Parameters

The clamping levels are two independent values to limit the output voltage range. The CLAMPLOW parameter adjusts the minimum output level. The CLAMPHIGH parameter sets the maximum output. Both parameters have 16 bits of adjustment and are available for all four LNR modes. As output data resolution is limited to 12bits, both in SENT and in PWM, the 4 LSB of this parameter will have no significant effect on the output. The value is encoded in fractional code, from 0% to 100%

13.3. Sensor Front-End

Parameter	Value
SENSING MODE	[0..3]
GAINMIN	[0..63]
GAINMAX	[0..63]
GAINSATURATION	[0, 1]

Table 63 - Sensing Mode and Front-End Configuration

13.3.1. SENSING MODE

The SENSING_MODE parameter defines which sensing mode and fields are used to calculate the angle. The different possibilities are described in the tables below. This 2 bits value selects the first (B1) and second (B2) field components according to the Table 64 content.

SENSING_MODE	B1	B2	Angular Mode	Compatible with
0	X	Y	Angular Rotary stray-field Immune	ordering code -100
1	X	Y	X-Y Angular Rotary	ordering code -300
2	Y	Z	Y-Z Angular Rotary	ordering code -300
3	X	Z	X-Z Angular Rotary	ordering code -300
4	ΔX	ΔZ	Linear position, stray-field Immune	ordering code -200

Table 64 - Sensing Mode Description

13.3.2. GAINMIN and GAINMAX Parameters

GAINMIN and GAINMAX define the thresholds on the gain code outside which the fault “GAIN out of Spec.” is reported (see Table 45, GainOOS). If GAINSATURATION is set, then the virtual gain code is saturated at GAINMIN and GAINMAX, and no Diagnostic fault is set since the saturations applies before the diagnostic is checked.

On the MLX90372 ACC the circuit will report a Gain Out of Spec error whenever the maximum gain of 63 is reached, regardless of the GAINMAX value.

13.4. Filtering

The MLX90372 includes 2 types of filters:

- Exponential moving average (EMA) Filter: programmable by the HYST parameter
- Low Pass FIR Filters controlled with the FILTER parameter

Parameter	Value
FILTER	0 ... 2
HYST	0 ... 255

Table 65 - Filtering configuration

13.4.1. Exponential Moving Average (IIR) Filter

The HYST parameter is a hysteresis threshold to activate / de-activate the exponential moving average filter. The output value of the IC is updated with the applied filter when the digital step is smaller than the programmed HYST parameter value. The output value is updated without applying the filter when the increment is bigger than the hysteresis. The filter reduces therefore the noise but still allows a fast step response for bigger angle changes. The hysteresis must be programmed to a value close to the internal magnetic angle noise level ($1\text{LSB} = 8 \cdot 360/2^{16}$).

$$y_n = a * x_n + (1-a) * y_{n-1}$$

$x_n = \text{Angle}$
 $y_n = \text{Output}$

The filters characteristic is given in the following table (Table 66):

DENOISING_FILTER_ALPHA_SEL	0	1	2	3
Coefficients a	0.75	0.5	0.25	0.125
Efficiency RMS (dB)		2.4	4.2	

Table 66 - IIR Filter characteristics

13.4.2. FIR Filters

The MLX90372 features 2 FIR filter modes controlled with Filter = 1...2. Filter = 0 corresponds to no filtering. The transfer function is described by:

$$y_n = \frac{1}{\sum_{i=0}^j a_i} \sum_{i=0}^j a_i x_{n-i}$$

This filter characteristic is given in the Table 67.

FILTER value	0	1	2
Type	Disable	Finite Impulse Response (FIR)	
Coefficients a_i	1	11	1111
Title	No filter	ExtraLight	Light
DSP cycles (nb of taps)	1	2	4
Efficiency RMS (dB)	0	3.0	6.0

Table 67 - FIR Filter Characteristics

13.5. Programmable Diagnostics Settings

13.5.1. Diagnostics Global Enable

DIAG_EN should be kept to its default value (1) to retain all functional safety capabilities of the MLX90372. This feature shall not be disabled.

13.5.2. Diagnostic Debouncer

A debouncing algorithm is available for analog diagnostic reporting (see chapter 14, Functional Safety). Enabling this debouncer will however increase the DCT of the device. Therefore, Melexis recommends keeping the debouncing of analog faults off by not modifying below described values (see Table 49 for factory defaults).

NVRAM Parameter	Description
DIAGDEBOUNCE_STEPDOWN	Decrement values for debouncer counter
DIAGDEBOUNCE_STEPUP	Increment value for debouncer counter
DIAG_DEBOUNCE_THRESH	Threshold for debouncer counter to enter diagnostic mode

Table 68 - Diagnostic debouncing parameters

Once an analog monitor detects an error, it takes control of the debouncing counter. This counter will be incremented by STEPUP value each time this specific monitor is evaluated, and the error is still present. When the debouncing counter reaches the value defined by DEBOUNCE THRESHOLD, an error is reported on the error channel, and the debouncing counter stays clamped to this DEBOUNCE THRESHOLD value

(see 11.1.8 for SENT error message codes, 13.5.4 for PWM error reporting). Once the error disappears, each time its monitor is evaluated, the debouncing counter is decremented by STEPDOWN value. When the debouncing counter reaches zero, the error disappears from the reporting channel and the debouncing counter is released. To implement proper reporting times, one should refer to the DCT defined in the Table 12. The reporting and recovery time are defined in the table below (valid for THRESH≠0).

Parameter	Min	Max
Reporting Time	$DCT \cdot \left(\left\lceil \frac{THRESH}{STEPUP} \right\rceil - 1 \right)$	$DCT \cdot \left(\left\lceil \frac{THRESH}{STEPUP} \right\rceil \right)$
Recovery Time	$DCT \cdot \left(\left\lceil \frac{THRESH}{STEPDOWN} \right\rceil \right)$	$DCT \cdot \left(\left\lceil \frac{THRESH}{STEPDOWN} \right\rceil + 1 \right)$
	$\left\lceil \frac{x}{y} \right\rceil$	is the ceiling function of x divided by y

Table 69 - Diagnostic Reporting and Recovery times

13.5.3. Over/Under Temperature Diagnostic

DIAG_TEMP_THR_HIGH defines the threshold for over temperature detection and is compared to the linearized value of the temperature sensor T_{LIN} . DIAG_TEMP_THR_LOW defines the threshold for under temperature detection and is compared to the linearized value of the temperature sensor T_{LIN} .

T_{LIN} is encoded using the SENT standard for temperature sensor. One can get the physical temperature of the die using following formula:

$$T_{PHY}[^{\circ}C] = \frac{T_{LIN}}{8} - 73.15$$

DIAG_TEMP_THR_LOW/HIGH are encoded on 8-bit unsigned values with the following relationship towards T_{Lin}

$$DIAG_TEMP_THR_(LOW/HIGH) = \frac{T_{LIN}}{16}$$

Following table summarizes the characteristics of the linearized temperature sensor and the encoding of the temperature monitor thresholds.

Parameter	Symbol	Min	Typ	Max	Unit	Condition
T_{LIN} resolution	Res _{TLIN}	-	0.125	-	°C/LSB	
T_{LIN} refresh rate	F _{S,TLIN}	-	200	-	Hz	
T_{LIN} linearity error	T _{LinErr}	-8	-	8	°C	from -40 to 160°C
T_{LIN} linearity error	T _{LinErr}	-2	-	6	°C	from 35 to 125°C

Parameter	Symbol	Min	Typ	Max	Unit	Condition
Low temperature threshold	DIAG_TEMP_THR_LOW	-	8	-	LSB	Recommended value, corresponds to -57°C
High temperature threshold	DIAG_TEMP_THR_HIGH	-	136	-	LSB	Recommended value, corresponds to 199°C
High/low temperature threshold resolution	Res _{Tthr}		2		°C/LSB	

Table 70 - Linearized Temperature Sensor characteristics

13.5.4. PWM Diagnostic

DC_FAULT

This parameter defines the duty-cycle that is present on the PWM output in case of diagnostic reporting.

WEAKMAGTHRESH

This parameter defines the threshold on the field strength which determines the weak magnet condition; when WEAKMAGTHRESH = 0, there is no reporting of weak magnet condition.

DC_FIELDTOOLOW

This parameter defines the duty-cycle that is output in case of Field Too Low; the Field Too Low Diagnostic is stronger than the Weak Magnet Diagnostic, from 0% till 100 % by steps of (100/256)%

DC_WEAK

This parameter defines the output duty-cycle in case of Weak Magnet, from 0% till 100% by steps of (100/256)%

14. Functional Safety

14.1. Safety Manual

The safety manual, available upon request, contains the necessary information to integrate the MLX90372 component in a safety related item, as Safety Element Out-of-Context (SEoC).

In particular it includes:

- The description of the Product Development lifecycle tailored for the Safety Element.
- An extract of the Technical Safety concept.
- The description of Assumptions-of-Use (AoU) of the element with respect to its intended use, including:
 - assumption on the device safe state;
 - assumptions on fault tolerant time interval and multiple-point faults detection interval;
 - assumptions on the context, including its external interfaces;
- The description of safety analysis results at the device level useful for the system integrator; HW architectural metrics and description of dependent failures initiators.
- The description and the result of the functional safety assessment process; list of confirmation measures and description of the independency level.

14.2. Safety Mechanisms

The MLX90372 provides numerous self-diagnostic features (safety mechanisms). Those features increase the robustness of the IC functionality by either preventing the IC to provide an erroneous output signal or reporting the failure according to the SENT protocol definition.

Legend
● High coverage
○ Medium coverage
ANA : Analog hardware failure reporting, described in the safety manual
High-Z : Special reporting, output is set in high impedance mode (no HW fail-safe mode/timeout, no SW safe startup)
DIG : Digital hardware failure reporting, described in the safety manual
* : Diagnostic Cycle Time (see 7.1 for values)
At Startup : HW fault present at time zero is detected before a first frame is transmitted.
DIAG_EN : This safety mechanism can be disabled by setting DIAG_EN = 0 (see 12 End-User Programmable Items). This option should not be used in application mode!

Table 71 - Self Diagnostic Legend

Category and safety mechanism name	Front-end	ADC	DSP	Back-end	Sup port. Func.	Module & Package	DCT*	Reporting mode	At startup	DIAG EN
Signal-conditioning (AFE, External Sensor) Diagnostic	●	●				●		ANA		
Magnetic Signal Conditioning Voltage Test Pattern	●	○	○				DCT_Ana	ANA		●
Magnetic Signal Conditioning Rough Offset Clipping check	●		○				DCT_Ana	ANA	NO	●
Magnetic Signal Conditioning Gain Monitor	●		○			●	DCT_Ana	ANA	YES	●
Magnetic Signal Conditioning Gain Clamping	●		○			●	DCT_Ana	ANA	YES	
Mag. Sig. Cond. Failure control by the chopping technique	●						n/a	n/a	YES	
External Sensor Sig. Cond. Voltage Valid Range Check	●					●	DCT_Ana	ANA	YES	○ ⁽⁴⁵⁾
External Sensor Sig. Cond. Frequency Valid Range Check	●					●	DCT_Ana	ANA	YES	●
A/D Converter Test Pattern		●					DCT_Ana	ANA		●
ADC Conversion errors & Overflow Errors		●					DCT_Ana	ANA	YES	●
Flux Monitor (Specific to Rotary mode)	●	○				●	DCT_Ana	ANA	YES	●
Digital-circuit Diagnostic			●					DIG		
RAM Parity, 1 bit per 16 bits word, ISO D.2.5.2			●				<10μs	DIG	YES	●
ROM Parity, 1 bit per 16 bits word, ISO D.2.5.2			●				<10μs	DIG	YES	●
NVRAM 16 bits signature (run-time) ISO D.2.4.3			●				DCT_dig	DIG		
NVRAM Single Error Correction ECC			●				n/a	n/a	YES	

⁴⁵ This safety mechanism is disabled by default.

Category and safety mechanism name	Front-end	ADC	DSP	Back-end	Sup port. Func.	Module & Package	DCT*	Reporting mode	At startup	DIAG EN
NVRAM Double Error Detection ECC ISO			●				DCT_Dig	DIG	YES	
Logical Monitoring of program sequence ISO D.2.9.3 via Watchdog "IWD" (cpu clock) ISO D2.9.2			●		○		Tiwd	DIG		●
Watchdog "AWD" (separate clock) ISO D2.9.1			●		○		Tawd	DIG		
CPU Errors "Invalid Address", "Wrong opcode"			●		○		<10μs	DIG	YES	
ADC Interface Checksum		●					DCT_Dig	DIG	NO	●
DSP Test Pattern (atan2)			●		○		DCT_Dig	DIG		●
Critical ports monitoring			●				DCT_Dig	DIG	NO	●
SENT H/W Interface Diagnostic				●				DIG		
SENT parity check over Configuration registers				●			<10μs	DIG	NO	●
SENT block: Protection against re-configuration at run-time				●			<10μs	DIG	NO	●
SENT Frame Counter & Redundant Nibble				●			n/a	n/a	n/a	
System-level diagnostic					●	●		ANA		
Supply Voltage Monitors (all supply domains) except VS_OV & POR					●	●	DCT_Ana	ANA	NO	●
External Supply Overvoltage Monitor VS_OV					●	●	2.1ms ⁽⁴⁶⁾	High-Z	YES	
Digital Supply under-voltage monitor (Power-on reset)					●	●	<10μs ⁽⁴⁷⁾	High-Z	YES	

⁴⁶ This DCT is valid for detection. The recovery time of this diagnostic is defined by DCT_Ana. The debouncer is not active for this diagnostic (13.5.2)

⁴⁷ After a detection of this diagnostic, the circuit performs a standard reset sequence. The recovery time of this diagnostic is consequently defined by the startup time (7.3.1).

Category and safety mechanism name	Front-end	ADC	DSP	Back-end	Sup port. Func.	Module & Package	DCT*	Reporting mode	At startup	DIAG EN
Supply Bias Current Monitor					●		DCT_Ana	ANA		●
Overheating monitor	○	○	○	○	○	●	DCT_Ana	ANA	YES	●
Warning/Reporting Mechanisms							n/a	n/a		
HW Error Controller			●	●	●		n/a	DIG	YES	
HW Fail-safe mode with timeout			●	●	●		n/a	DIG	YES	
Analog-type Error management	●	●			●		n/a	ANA		
Safe start-up mode			●		●		n/a	DIG	n/a	
Mechanisms executed at start-up only										
RAM March-C HW Test at start-up			●		●		n/a	DIG	YES	

Table 72 - MLX90372 List of Self Diagnostics with Characteristics

15. Recommended Application Diagrams

15.1. Wiring with the MLX90372 in SOIC-8 Package



fig. 24 - Recommended wiring for the MLX90372 in SOIC-8 package

Component	min	Typ	Max	Remark
C ₁	100 nF	220 nF	-	Close to the IC pin
C ₂ (C _L)	-	4.7nF 2.2nF	10nF 4.7nF	normal SENT/PWM fast SENT
C ₃	47 nF	100 nF	-	Close to the IC pin
C ₄	0	1nF	-	Close to the connector
C ₅	0	1nF	15nF	Close to the connector
R ₁	0	10 Ω	-	Recommended value
R ₂	0	120 Ω	220 Ω	Recommended value

Table 73 - Recommended Values for the MLX90372 in SOIC-8 Package

15.2. Wiring with the MLX90372 in TSSOP-16 Package

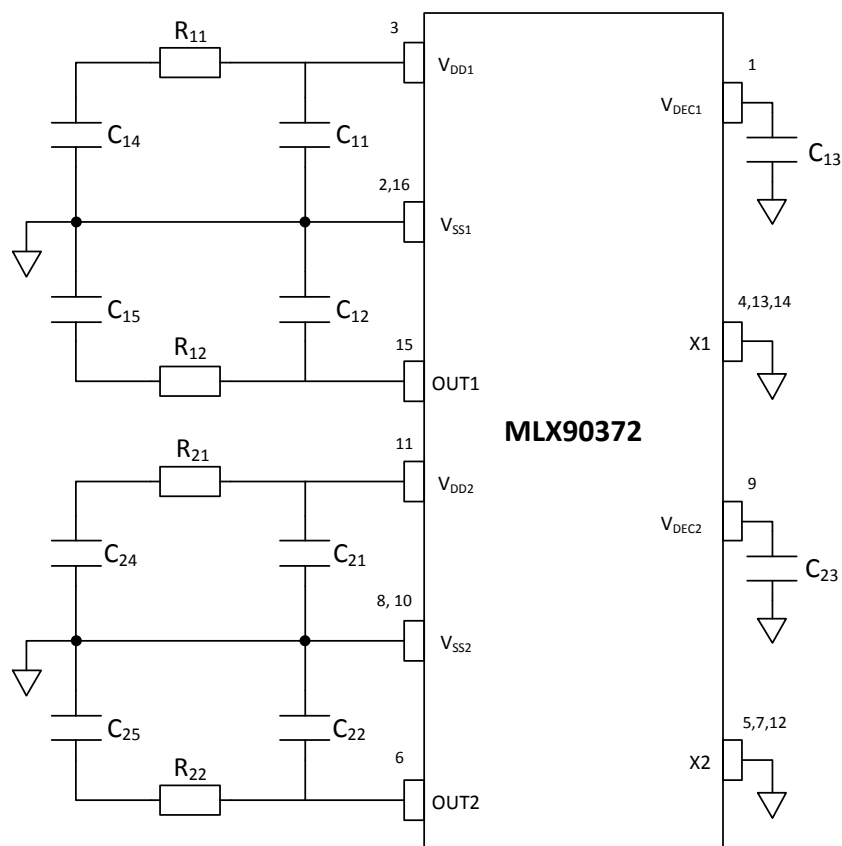

fig. 25 - Recommended wiring for the MLX90372 in TSSOP-16 package (dual die)

Component	min	Typ	Max	Remark
C _{x1}	100 nF	220 nF	-	Close to the IC pin
C _{x2} (C _L)	-	4.7nF 2.2nF	10nF 4.7nF	normal SENT/PWM fast SENT
C _{x3}	47 nF	100 nF	-	Close to the IC pin
C _{x4}	0	1nF	-	Close to the connector
C _{x5}	0	1nF	15nF	Close to the connector
R _{x1}	0	10 Ω	-	Recommended value
R _{x2}	0	120 Ω	220 Ω	Recommended value

Table 74 - Recommended Values for the MLX90372 in TSSOP-16 Package

15.3. Wiring with the MLX90372 in DMP-4 Package (built-in capacitors)



fig. 26 - Internal wiring of the MLX90372 in DMP-4

Component	Value	Remark
C1	220 nF	Ordering code -10x, -20x, -30x
C2	4.7 nF	
C3	100 nF	
C4	-	
C1	220 nF	Ordering code -31x
C2	10 nF	
C3	100 nF	
C4	220 nF	

Table 75 - DMP-4 capacitors configuration

For best EMC performances, only pin 4-V_{SS} should be connected to the electrical ground.

16. Standard information regarding manufacturability of Melexis products with different soldering processes

Our products are classified and qualified regarding soldering technology, solderability and moisture sensitivity level according to standards in place in Semiconductor industry.

For further details about test method references and for compliance verification of selected soldering method for product integration, Melexis recommends reviewing on our web site the General Guidelines soldering recommendation (<http://www.melexis.com/en/quality-environment/soldering>)

For all soldering technologies deviating from the one mentioned in above document (regarding peak temperature, temperature gradient, temperature profile etc), additional classification and qualification tests have to be agreed upon with Melexis.

For package technology embedding trim and form post-delivery capability, Melexis recommends consulting the dedicated trim & form recommendation application note : “Lead Trimming and Forming Recommendations” (<https://www.melexis.com/en/documents/documentation/application-notes/application-note-lead-trimming-and-forming-recommendations>).

Melexis is contributing to global environmental conservation by promoting lead free solutions. For more information on qualifications of RoHS compliant products (RoHS = European directive on the Restriction Of the use of certain Hazardous Substances) please visit the quality page on our website: <http://www.melexis.com/en/quality-environment>.

17. ESD Precautions

Electronic semiconductor products are sensitive to Electro Static Discharge (ESD).

Always observe Electro Static Discharge control procedures whenever handling semiconductor products.

18. Package Information

18.1. SOIC-8 - Package Dimensions



fig. 27 - SOIC-8 Package Outline Dimensions

18.2. SOIC-8 - Pinout and Marking



fig. 28 - SOIC-8 Pinout and Marking

18.3. SOIC-8 - Sensitive spot positioning

18.3.1. Rotary Stray-field Immune and Standard Mode Applications

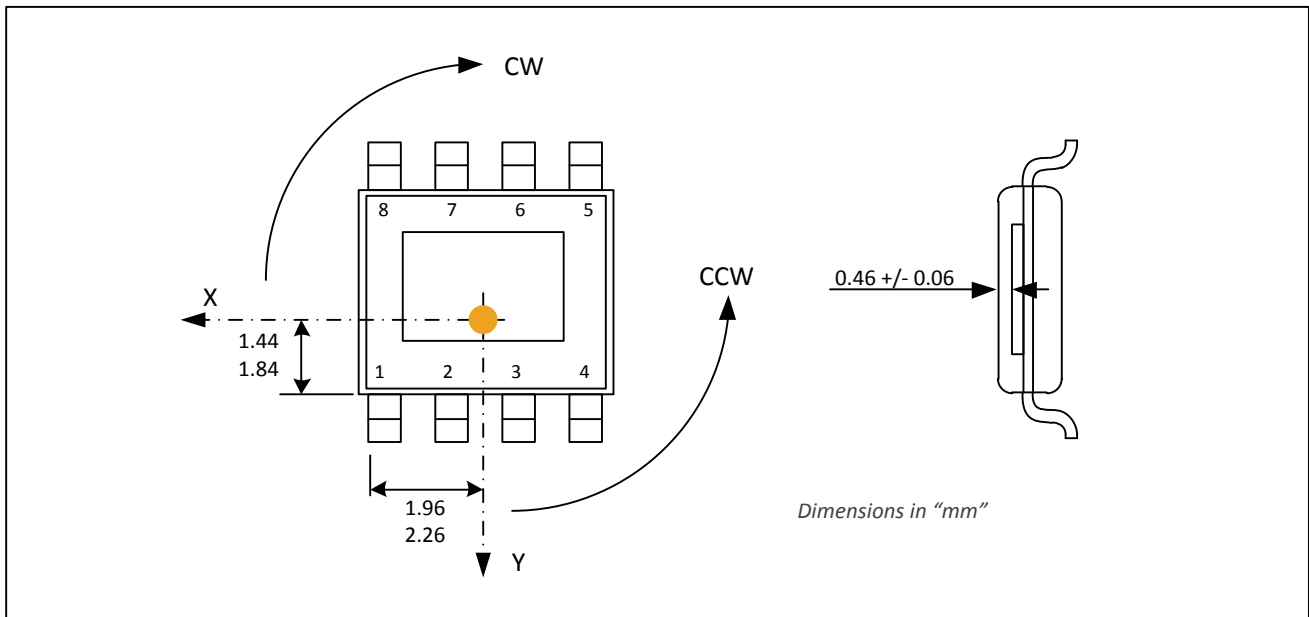

fig. 29 - SOIC-8 Sensitive Spot Position

18.3.2. Linear Stray-field Immune Applications

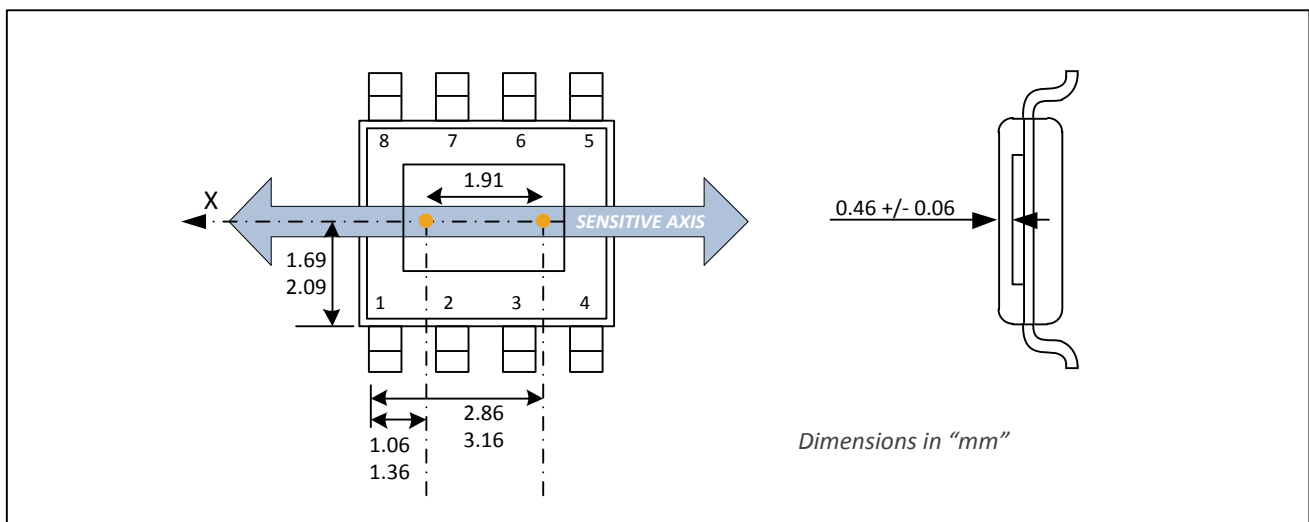

fig. 30 - SOIC-8 Sensitive Spot position for Linear Stray-Field Immune

18.4. SOIC-8 - Angle detection



fig. 31 - SOIC-8 Angle Detection

The MLX90372 is an absolute angular position sensor but the linearity error (See section 9.1.1) does not include the error linked to the absolute reference 0 Deg (which can be fixed in the application through the discontinuity point).

18.5. TSSOP-16 - Package Dimensions



fig. 32 - TSSOP-16 Package Outline Dimensions

18.6. TSSOP-16 - Pinout and Marking

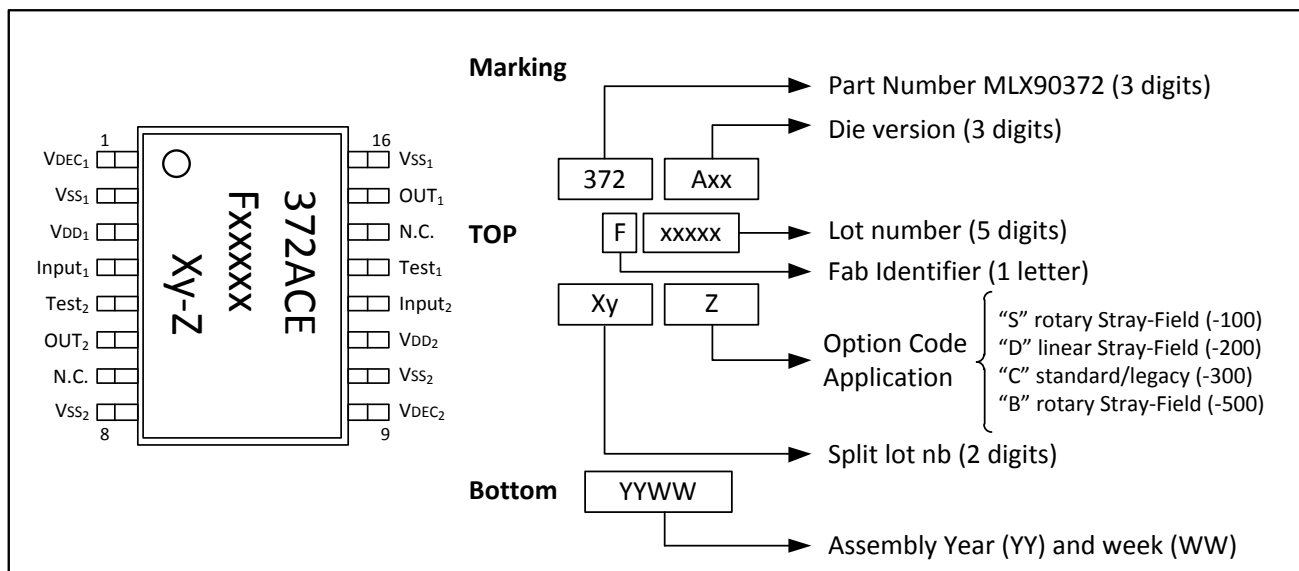

fig. 33 - TSSOP-16 Pinout and Marking

18.7. TSSOP-16 - Sensitive spot positioning

18.7.1. Rotary Stray-field Immune and Standard Mode applications

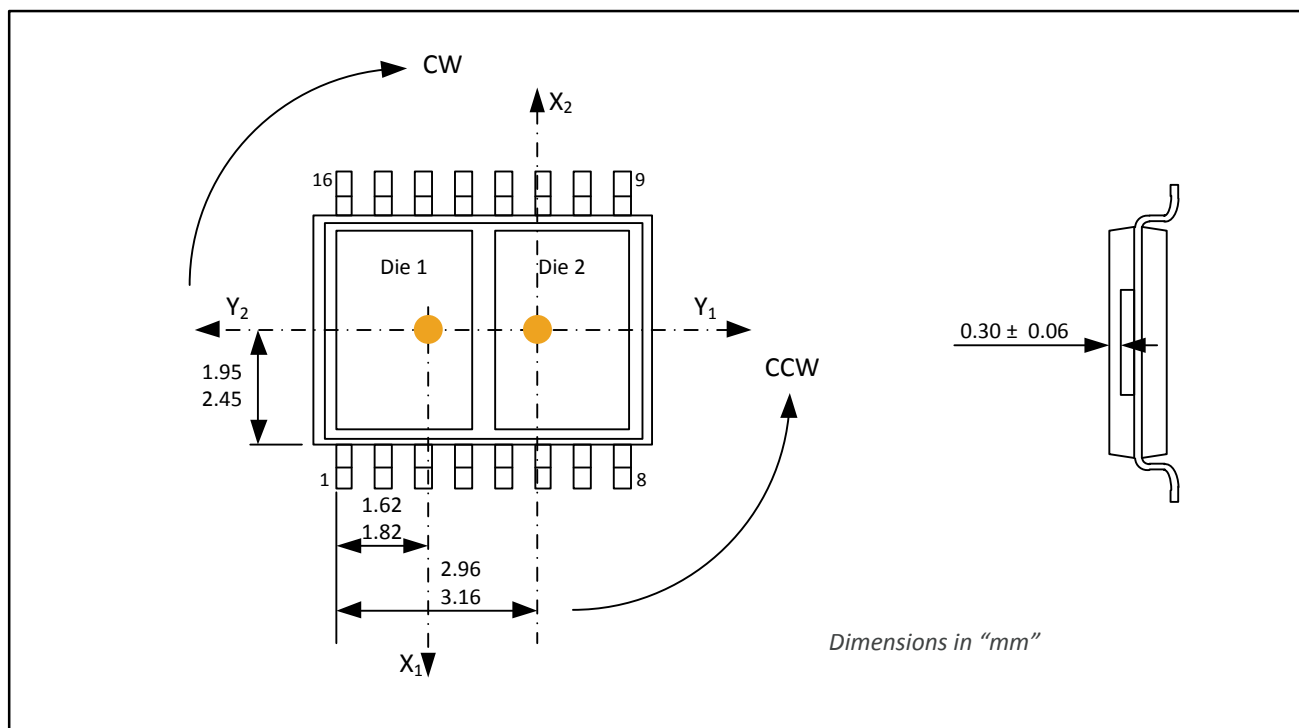

fig. 34 - TSSOP-16 Sensitive Spot Position

18.7.2. Linear Stray-field Immune Applications



fig. 35 - TSSOP-16 - Sensitive Spot Location for Linear Stray-field Immune

18.8. TSSOP-16 - Angle Detection



fig. 36 - TSSOP-16 Angle Detection

The MLX90372 is an absolute angular position sensor but the linearity error (See section 9.1.1) does not include the error linked to the absolute reference 0Deg (which can be fixed in the application through the discontinuity point).

18.9. DMP-4 - Package Outline Dimensions (POD) - STD1 1.27



fig. 37 - DMP-4 STD1 1.27 Package Outline Drawing

18.10. DMP-4 - Package Outline Dimensions (POD) - STD1 2.54



fig. 38 - DMP-4 STD1 2.54 Package Outline Drawing

18.11. DMP-4 - Package Outline Dimensions (POD) - STD2 2.54



fig. 39 - DMP-4 STD2 2.54 Package Outline Drawing

18.12. DMP-4 - Package Outline Dimensions (POD) - STD3 2.00



fig. 40 - DMP-4 STD3 2.00 Package Outline Drawing

18.13. DMP-4 - Package Outline Dimensions (POD) - STD4 2.54

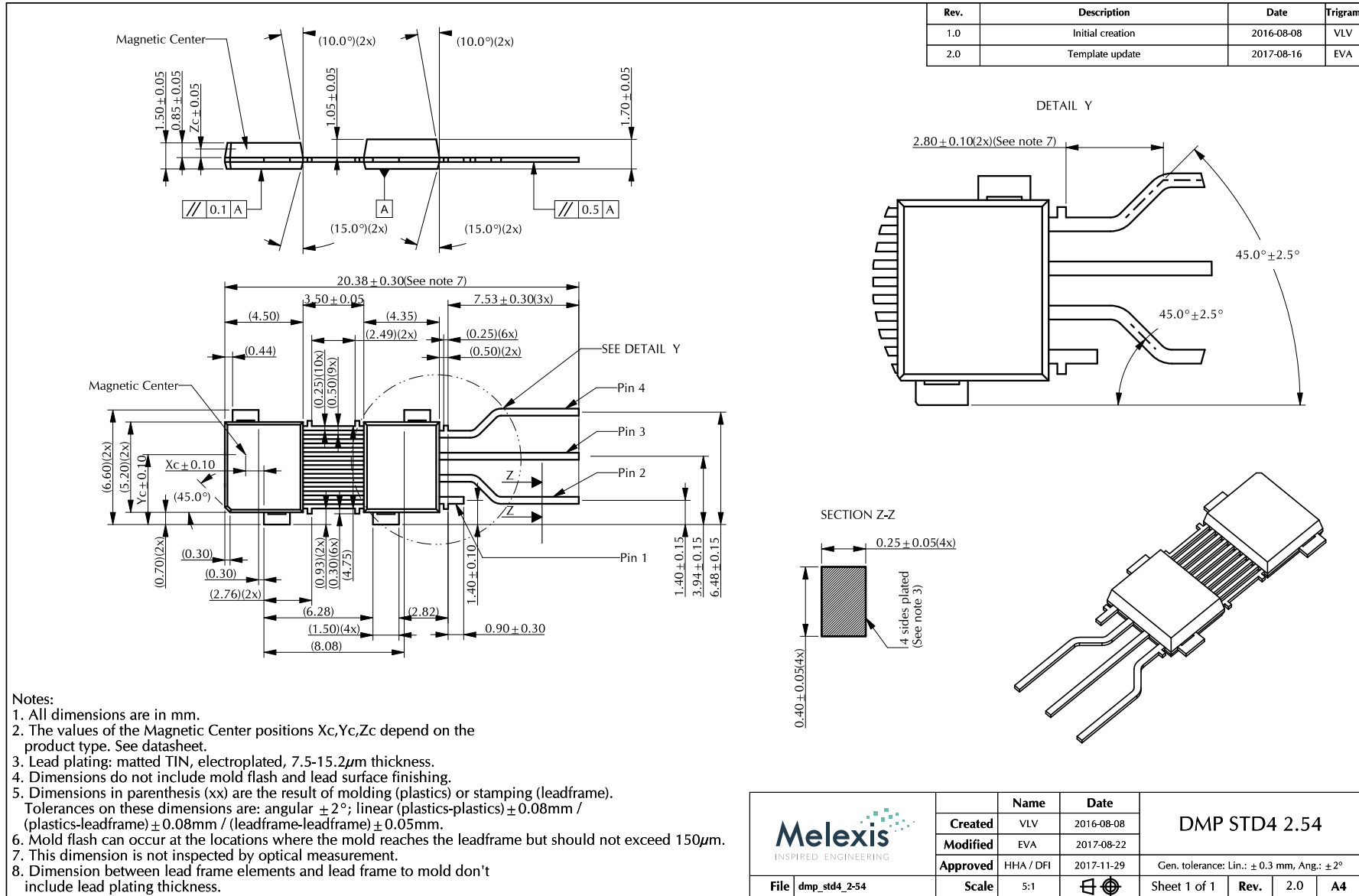

fig. 41 - DMP-4 STD4 2.54 Package Outline Drawing

18.14. DMP-4 - Marking



fig. 42 - DMP-4 Marking

18.15. DMP-4 - Sensitive Spot Positioning

18.15.1. Rotary Stray-field Immune or Standard Mode Applications

DMP#1 - Pinout A (see 3.3)



fig. 43 - DMP-4 Rotary Stray-field or legacy Sensitive Spot Position

DMP#2 - Pinout B (see 3.4)



fig. 44 - DMP-4 Rotary Stray-field or legacy Sensitive Spot Position

18.15.2. Linear Stray-field Immune Applications

DMP#1 - Pinout A (see 3.3)



fig. 45 - DMP-4 Linear Stray-field Sensitive Spot Position

DMP#2 - Pinout B (see 3.4)



fig. 46 - DMP-4 Linear Stray-field Sensitive Spot Position

18.16. DMP-4 - Angle detection



fig. 47 - DMP-4 Angle Detection

The MLX90372 is an absolute angular position sensor but the linearity error (See section 9.1.1) does not include the error linked to the absolute reference 0 Deg (which can be fixed in the application through the discontinuity point).

18.17. Packages Thermal Performances

The table below describe the thermal behaviour of available packages following JEDEC EIA/JESD 51.X standard.

Package	Junction to case - θ_{jc}	Junction to ambient - θ_{ja} (JEDEC 1s2p board)	Junction to ambient - θ_{ja} (JEDEC 1s0p board)
SOIC-8	38.8 K/W	112 K/W	153 K/W
TSSOP-16	27.6 K/W	99.1 K/W	137 K/W
DMP-4	32.2 K/W	88.7 K/W	done without PCB ⁽⁴⁸⁾

Table 76 - Standard Packages Thermal Performances

⁴⁸ DMP-4 as PCB-less solution has been evaluated in a typical application case. Values for this package are given as informative.

19. Contact

For the latest version of this document, go to our website at www.melexis.com.

For additional information, please contact our Direct Sales team and get help for your specific needs:

Europe, Africa	Telephone: +32 13 67 04 95
	Email : sales_europe@melexis.com
Americas	Telephone: +1 603 223 2362
	Email : sales_usa@melexis.com
Asia	Email : sales_asia@melexis.com

20. Disclaimer

The information furnished by Melexis herein ("Information") is believed to be correct and accurate. Melexis disclaims (i) any and all liability in connection with or arising out of the furnishing, performance or use of the technical data or use of the product(s) as described herein ("Product") (ii) any and all liability, including without limitation, special, consequential or incidental damages, and (iii) any and all warranties, express, statutory, implied, or by description, including warranties of fitness for particular purpose, non-infringement and merchantability. No obligation or liability shall arise or flow out of Melexis' rendering of technical or other services.

The Information is provided "as is" and Melexis reserves the right to change the Information at any time and without notice. Therefore, before placing orders and/or prior to designing the Product into a system, users or any third party should obtain the latest version of the relevant information to verify that the information being relied upon is current.

Users or any third party must further determine the suitability of the Product for its application, including the level of reliability required and determine whether it is fit for a particular purpose.

The Information is proprietary and/or confidential information of Melexis and the use thereof or anything described by the Information does not grant, explicitly or implicitly, to any party any patent rights, licenses, or any other intellectual property rights.

This document as well as the Product(s) may be subject to export control regulations. Please be aware that export might require a prior authorization from competent authorities.

The Product(s) are intended for use in normal commercial applications. Unless otherwise agreed upon in writing, the Product(s) are not designed, authorized or warranted to be suitable in applications requiring extended temperature range and/or unusual environmental requirements. High reliability applications, such as medical life-support or life-sustaining equipment are specifically not recommended by Melexis.

The Product(s) may not be used for the following applications subject to export control regulations: the development, production, processing, operation, maintenance, storage, recognition or proliferation of 1) chemical, biological or nuclear weapons, or for the development, production, maintenance or storage of missiles for such weapons; 2) civil firearms, including spare parts or ammunition for such arms; 3) defense related products, or other material for military use or for law enforcement; 4) any applications that, alone or in combination with other goods, substances or organisms could cause serious harm to persons or goods and that can be used as a means of violence in an armed conflict or any similar violent situation.

The Products sold by Melexis are subject to the terms and conditions as specified in the Terms of Sale, which can be found at <https://www.melexis.com/en/legal/terms-and-conditions>.

This document supersedes and replaces all prior information regarding the Product(s) and/or previous versions of this document.

Melexis NV © - No part of this document may be reproduced without the prior written consent of Melexis. (2019)

ISO/TS 16949 and ISO14001 Certified