

# MAX22513 Evaluation Kit

Evaluates: MAX22513

## General Description

The MAX22513 evaluation kit (EV kit) consists of the evaluation board and software. The EV kit is a fully assembled and tested circuit board that evaluates the MAX22513 IO-Link® device transceiver with integrated DC-DC buck regulators.

The EV kit includes Windows®-compatible software that provides a graphical user interface (GUI) for exercising the features of the MAX22513. The EV kit is connected to a PC through a USB-A-to-micro-B cable.

## Features

- IO-Link-Compliant Device Transceiver
- I/O, I<sup>2</sup>C, and SPI Interface Terminals
- Arduino® Compatible Connector
- Windows 10-Compatible Software
- USB-PC Connection
- Proven PCB Layout
- Fully Assembled and Tested

**Ordering Information** appears at end of data sheet.

Arduino is a registered trademark of Arduino, LLC.

IO-Link is a registered trademark of Profibus User Organization (PNO).

Windows is registered trademark and registered service mark of Microsoft Corporation.

## Quick Start

### Recommended Equipment

- MAX22513 EV kit (USB-A-to-micro-B cable included)
- User-supplied Windows 10 PC with a spare USB port
- 24V, 1A DC power supply
- Multimeter/voltmeter

**Note:** In the following sections, software-related items are identified by bolding. Text in **bold** refers to items directly from the EV kit software. Text in **bold and underlined** refers to items from the Windows operating system.

### Procedure

The EV kit is fully assembled and tested. Follow the steps below to verify board operation before exercising the full features of the device:

- 1) Visit [www.maximintegrated.com/evkitsoftware](http://www.maximintegrated.com/evkitsoftware) to download the latest version of the EV kit software, MAX22513EVKITSetupVx.xx.ZIP. Save the EV kit software to a temporary folder and uncompress the ZIP file.
- 2) Install the EV kit software and USB driver on your computer by running the MAX22513EVKITSetupVx.xx.EXE program inside the temporary folder. The program files are copied to your PC and icons are created in the Windows **Start | Programs | Maxim Integrated** menu. During software installation, some versions of Windows can show a warning message indicating that this software is from an unknown publisher. This is not an error condition and it is safe to proceed with installation. Administrator privileges are required to install the USB device driver on Windows.

## MAX22513 EV Kit Block Diagram

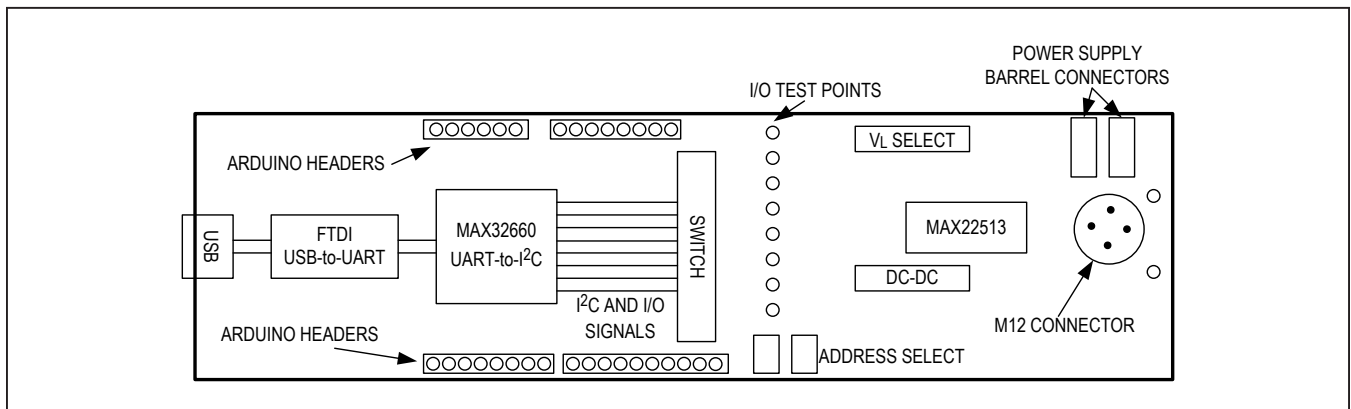

- 3) Verify that all the jumpers are in their default positions, as shown in [Table 1](#).
- 4) Connect the 24V DC power supply to the V<sub>24</sub> (TP24) and GND (TP7) barrel connectors or to the V<sub>24</sub> (TP1) and GND (TP9) test points on the EV kit board.
- 5) Connect the multimeter to the V<sub>5</sub> testpoint (TP22)
- 6) Turn on the V<sub>24</sub> power supply. Ensure that the voltage on V<sub>5</sub> (TP22) is 5V.
- 7) Connect the USB cable from the PC to the EV kit board. A Windows message appears when connecting the EV kit.
- 8) Start the EV kit software by opening its icon in the Windows **Start | Programs | Maxim Integrated** menu. The EV kit software main window appears, as shown in [Figure 1](#).
- 9) Verify that **Status: MAX32660 Connected, MAX22513 ADR = 0x68** is displayed on the status bar at the bottom left of the main window ([Figure 1](#)).
- 10) Click on the Include Interrupt Register box to include the INTERRUPT register in serial interface reads. Click on the **Read All** button to read all of the registers in the device.
- 11) Select a register in the top register table to access the bits in that register.
- 12) Set the individual bits for that register by selecting available settings from the drop-down menu for each bit in the lower register table.
- 13) Press the **Write Modified** button on the GUI to write the registers that have been changed to the MAX22513.

## Detailed Description of Software

### Configuring the Registers

Click on a register name in the top register table to access the individual bits in that register. When the register name is selected in the register table, the lower register table shows the individual bits for that register. Click on the drop-down menu next to each bit in the lower table to select the bit setting. When all of the bits are set as desired, click on the Write Modified button to write the changed bit settings to the MAX22513 over the I<sup>2</sup>C interface.

Note that full IO-Link communication is not available using the EV kit GUI.

### I/O Pin Control

The IO-Link UART I/Os (TXEN, TX, RX, LO/LI) and notification interrupt ( $\overline{\text{IRQ}}$  and WU) pins can be controlled and read on the MAX22513 EV kit GUI. Click on the toggle buttons next to TXEN, TX, and LO/LI (DO\_EN = 1) to set these pins on the EV kit board to high (V<sub>L</sub>) or low (GND).

When an interrupt is triggered, a bit in the INTERRUPT register is set and  $\overline{\text{IRQ}}$  asserts low. A yellow tag appears in the I/O Pins box stating "Interrupt Received" ([Figure 2](#)). Read the INTERRUPT register to clear the interrupt and deassert  $\overline{\text{IRQ}}$ .

When a wake-up event is detected, and the WUINT is not masked in the INTERRUPT register (WUM = 0), the wake-up interrupt bit is set in the INTERRUPT register and a yellow tag appears in the I/O Pins box stating "Wak-Up Received."  $\overline{\text{IRQ}}$  also asserts. Read the INTERRUPT register to clear the interrupt and deassert  $\overline{\text{IRQ}}$ . The green box next to WU flashes orange briefly and then turns green again.

## Detailed Description of Hardware

The MAX22513 EV kit includes the MAX22513 dual-channel IO-Link transceiver and the external components for evaluating the device. The EV kit is configured for I<sup>2</sup>C operation by default. All logic-level I/Os and IO-Link capable I/Os are available on yellow test points.

### Logic-Level Power Supply

The MAX22513 features an internal 3.3V linear regulator which can drive loads up to 50mA. Set V<sub>L</sub> = 3.3V on the J6 jumper to set the logic level supply (V<sub>L</sub>) for the I/O pins.

To use a different logic-level voltage supply, open the J6 jumper and apply the external supply to the V<sub>L</sub> testpoint (TP23). *Ensure that V<sub>L</sub> does not exceed 3.3V to protect the MAX32660.*

### Selecting the Device Address

The MAX22513 includes two address pins for I<sup>2</sup>C addressing, allowing up to four devices on a single bus. Set the I<sup>2</sup>C address for the MAX22513 on the MAX22513EVKIT by setting the SDI/A1 and CS/A0 jumpers (J11 and J8, respectively). Click the Rescan I<sup>2</sup>C Adr button after the address has been changed to reestablish I<sup>2</sup>C communication.

### Using I<sup>2</sup>C or SPI Interface with an External Master Controller

The MAX22513 EV kit includes an isolated USB-to-serial interface circuit for communication with the PC/GUI, and is configured to operate with the I<sup>2</sup>C serial interface when using the on-board FTDI converter and Maxim MAX32660 microcontroller. Arduino headers are available to use the board with an external controller.

To use an external SPI or I<sup>2</sup>C controller with the MAX22513, open all the switches on SW1 (set all switches to the left) and connect the external controller to the P5, P6, P7, and P8 headers. The MAX22513 EV kit is configured for I<sup>2</sup>C communication by default. To enable the SPI interface, remove the R23 resistor and place a 10kΩ resistor in R4 and remove the shunts on J8 and J11.

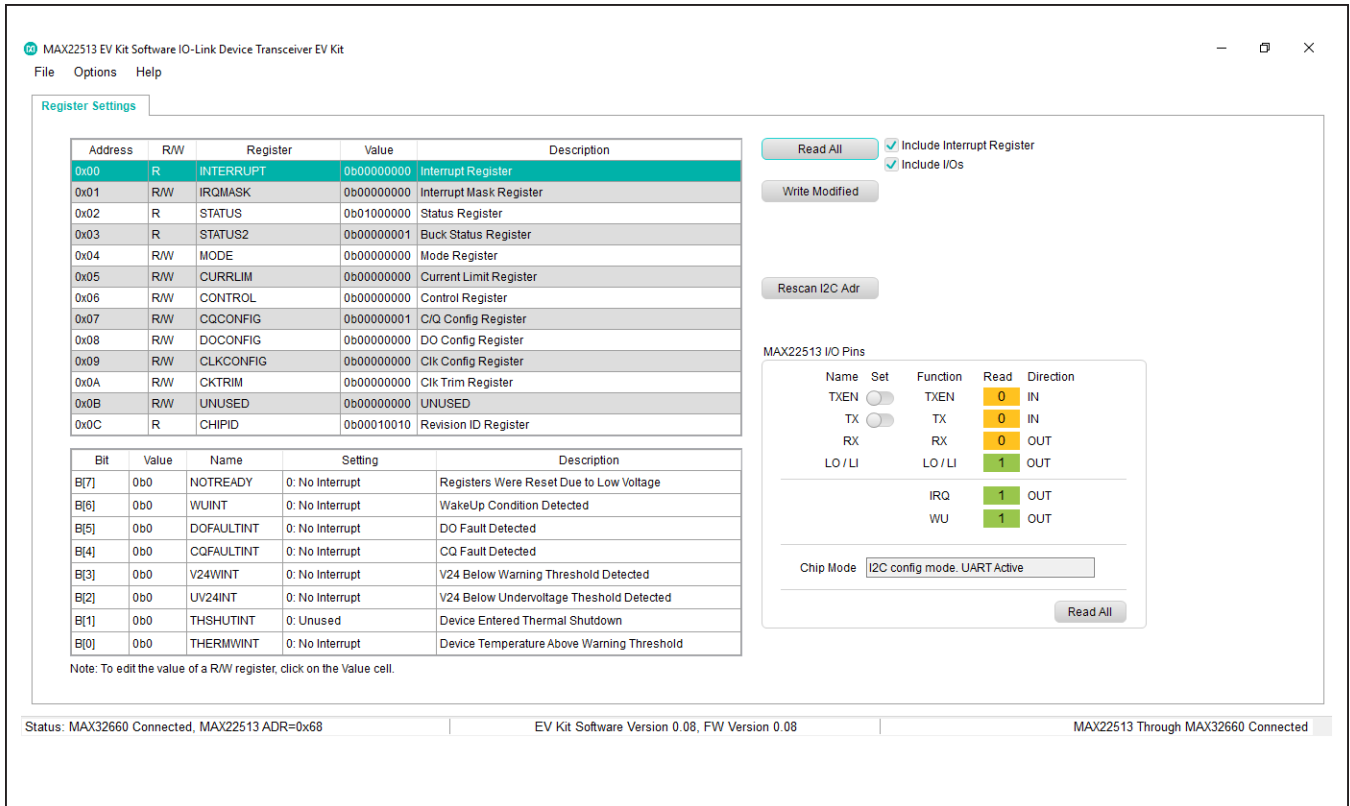

Figure 1. MAX22513 EV Kit Software, EV Kit is Connected

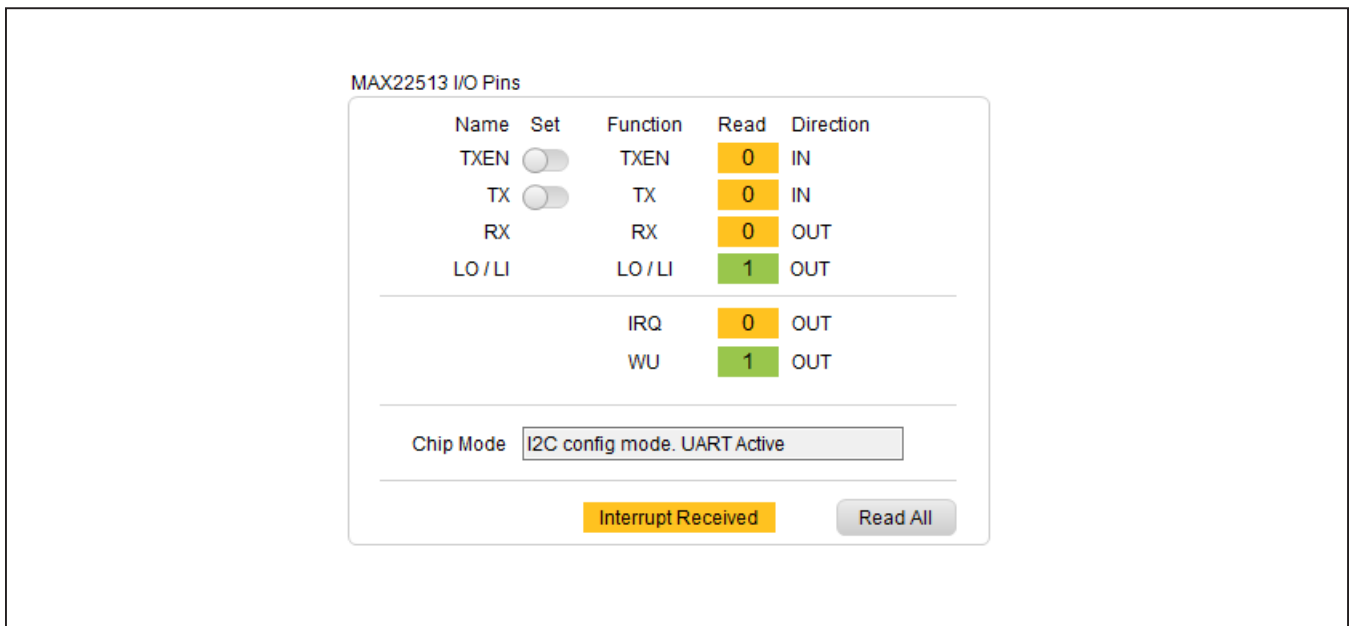

Figure 2. MAX22513 EV Kit Software, Interrupt Received

**Table 1. Jumper Descriptions**

JUMPER	SHUNT POSITON	DESCRIPTION
J1	1–2*	LIN is connected to the output of the DC-DC regulator.
	1–3	LIN is connected to PV24.
	1–4	LIN is connected to V <sub>5</sub> . Connect an external 5V supply to V <sub>5</sub> .
J2	Open*	FREQ is low
	Closed	FREQ is high
J3	Open*	$\overline{\text{RESET}}$ is pulled up to V <sub>L</sub> through a 10kΩ resistor.
	Closed	$\overline{\text{RESET}}$ is low
J6	1–2	V <sub>L</sub> is connected to V <sub>5</sub> (V <sub>L</sub> = 5V)
	2–3*	V <sub>L</sub> is connected to V <sub>33</sub> (V <sub>L</sub> = 3.3V)
J8	1–2	$\overline{\text{CS/A0}}$ is high
	2–3*	$\overline{\text{CS/A0}}$ is low
J10	1–2*	TXEN is high
	2–3	TXEN is low
J11	1–2	SDI/A1 is low
	2–3*	SDI/A1 is high
J15	Open	Do not use.
J16	1–2	MCLK is connected to the 32KIN input of the MAX32660.
	2–3*	Output of the on-board oscillator is connected to the 32KIN input of the MAX32660

\*Default position.

## Ordering Information

PART	TYPE
MAX22513EVKIT#	EV Kit

#Denotes a RoHS-compliant device that may include lead that is exempt under the RoHS requirements.

MAX22513 EV Kit Bill of Materials

ITEM	REF DES	DNI/DNP	QTY	MFG PART #	MANUFACTURER	VALUE	DESCRIPTION
1	C1	-	1	CGA3EANP02A103J080AC	TDK	0.01UF	CAPACITOR; SMT (0603); CERAMIC CHIP; 0.01UF; 100V; TOL=5%; MODEL=MULTILAYER CERAMIC CHIP CAPACITOR; TC=NPO
2	C2	-	1	UMK107AB7105KA;CC0603KRX7R9BB105	TAIYO YUDEN;YAGEO	1UF	CAPACITOR; SMT (0603); CERAMIC CHIP; 1UF; 50V; TOL=10%; TG=-55 DEGC TO +125 DEGC; TC=X7R
3	C3, C5, C8	-	3	CL05B105KQSNQNC; GRM155R7J105KA12	SAMSUNG ELECTRONICS;MURATA	1UF	CAPACITOR; SMT (0402); CERAMIC CHIP; 1UF; 6.3V; TOL=10%; TG=-55 DEGC TO +125 DEGC; TC=X7R
4	C4	-	1	C3216XSR1H685K160A8	TDK	6.8UF	CAPACITOR; SMT (1206); CERAMIC CHIP; 6.8UF; 50V; TOL=10%; TG=-55 DEGC TO +85 DEGC; TC=X5R
5	C6, C7, C10, C11	-	4	C0402X7R500-331KNE;GRM155R71H331KA01;ECJ-0EB1H331K	VENKEL LTD;MURATA;PANASONIC	330PF	CAPACITOR; SMT (0402); CERAMIC CHIP; 330PF; 50V; TOL=10%; TG=-55 DEGC TO +125 DEGC; TC=X7R
6	C9	-	1	GCI188R71H104KA12; GCM188R71H104K; CGA3E2X7R1H104K080AA	MURATA;MURATA;TDK	0.1UF	CAPACITOR; SMT (0603); CERAMIC CHIP; 0.1UF; 50V; TOL=10%; TG=-55 DEGC TO +125 DEGC; TC=X7R; AUTO
7	C14	-	1	C0603C105K4RAC;GRM188R71C105KA12;C1608 X7R1C105K080AC;EMK107B7105KA;GCM188R71C105KA64;CGA3E1X7R1C105K080AC	KEMET;MURATA;TDK;TAIYO YUDEN;MURATA;TDK	1UF	CAPACITOR; SMT (0603); CERAMIC CHIP; 1UF; 16V; TOL=10%; MODEL=X7R; TG=-55 DEGC TO +125 DEGC; TC=X7R
8	C15	-	1	KTS250B336M55N0T00	NIPPON CHEMI-CON	33UF	CAPACITOR; SMT (2220); CERAMIC; 33UF; 25V; TOL=20%; MODEL=X7R; TG=-55 DEGC TO +125 DEGC; TC=+
9	C16	-	1	GRM155R71H332KA01	MURATA	3300PF	CAPACITOR; SMT (0402); CERAMIC CHIP; 3300PF; 50V; TOL=10%; TG=-55 DEGC TO +125 DEGC; TC=X7R
10	C17	-	1	EMK107B7105MA	TAIYO YUDEN	1UF	CAPACITOR; SMT (0603); CERAMIC CHIP; 1UF; 16V; TOL=20%; MODEL=M SERIES; TG=-55 DEGC TO +125 DEGC; TC=X7R
11	C18	-	1	GRM21BR61A106KE19;ECJ-2F81A106;CL21A106KPLQNC;GRM219R61A10 G6E44	MURATA;PANASONIC;SAMSUNG ELECTRONICS;MURATA	10UF	CAPACITOR; SMT (0805); CERAMIC CHIP; 10UF; 10V; TOL=10%; MODEL=X7R; TG=-55 DEGC TO +85 DEGC; TC=X5R
12	C19	-	1	C0603X7R1A103K030BA;GRM033R71A103KA01 ;GCM033R71A103KA03;CGA1A2X7R1A103K030 BA;0201ZC103KA12A	TDK;MURATA;MURATA;TDK;AVX	0.01UF	CAPACITOR; SMT (0201); CERAMIC CHIP; 0.01UF; 10V; TOL=10%; TG=-55 DEGC TO +125 DEGC; TC=X7R
13	C20	-	1	GRM188F51A475Z	MURATA	4.7UF	CAPACITOR; SMT (0603); CERAMIC CHIP; 4.7UF; 10V; TOL=+80%-20%; MODEL=GRM SERIES; TG=-30 DEGC TO +85 DEGC; TC=YSV
14	C21, C25	-	2	GRM033R61A104KE15; LMK063B1J04KP	MURATA;TAIYO YUDEN	0.1UF	CAPACITOR; SMT (0201); CERAMIC CHIP; 0.1UF; 10V; TOL=10%; MODEL=X7R; TG=-55 DEGC TO +125 DEGC; TC=X5R
15	C22, C23	-	2	GRM0335C1E470J0A1	MURATA	47PF	CAPACITOR; SMT (0201); CERAMIC CHIP; 47PF; 25V; TOL=5%; TG=-55 DEGC TO +125 DEGC; TC=COG
16	C24	-	1	C0201C104K9PAC;GRM033R60J104KE19;C0603 X5R0104K030BC;C0201X5R6R3-104KNP	KEMET;MURATA;VENKEL;TDK	0.1UF	CAPACITOR; SMT (0201); CERAMIC CHIP; 0.1UF; 6.3V; TOL=10%; MODEL=X5R; TG=-25 DEGC TO +85 DEGC; TC=+
17	C26, C27	-	2	C0402C105K8PAC;CC0402KRX5R6BB105	KEMET;YAGEO	1UF	CAPACITOR; SMT (0402); CERAMIC CHIP; 1UF; 10V; TOL=10%; TG=-55 DEGC TO +85 DEGC; TC=X5R
18	J1	-	1	TSW-104-07-L-S	SAMTEC	TSW-104-07-L-S	EVKIT PART-CONNECTOR; MALE; THROUGH HOLE; TSW SERIES; SINGLE ROW; STRAIGHT; 4PINS
19	J2, J3	-	2	TSW-102-07-T-S	SAMTEC	TSW-102-07-T-S	CONNECTOR; THROUGH HOLE; TSW SERIES; SINGLE ROW; STRAIGHT; 2PINS; -55 DEGC TO +105 DEGC
20	J6, J8, J10, J11, J16	-	5	TSW-103-07-T-S	SAMTEC	TSW-103-07-T-S	CONNECTOR; THROUGH HOLE; TSW SERIES; SINGLE ROW; STRAIGHT; 3PINS
21	J7	-	1	09 0431 212 04	BINDER	09 0431 212 04	CONNECTOR; MALE; TH; MALE RECEPTACLE; THREADED; PCB SOLDER; STRAIGHT; 4PINS;
22	J9	-	1	ZX62D-AB-5P8	HIROSE ELECTRIC CO LTD.	ZX62D-AB-5P8	CONNECTOR; FEMALE; SMT; USB MICRO CONNECTOR; RIGHT ANGLE; 5PINS
23	J15	-	1	FTSH-105-01-L-DV-K	SAMTEC	FTSH-105-01-L-DV-K	CONNECTOR; MALE; SMT; 0.05 (1.27MM) SMT MICRO HEADER; STRAIGHT; 10PINS
24	L1	-	1	LP54018-183MR	COILCRAFT	18UH	INDUCTOR; SMT; FERRITE; 18UH; 20%; 1.00A
25	L2	-	1	LP56235-333MR	COILCRAFT	33UH	INDUCTOR; SMT; MAGNETICALLY SHIELDED; 33UH; TOL=+/-20%; 1.3A
26	L3	-	1	BLM21AG6015N1	MURATA	600	INDUCTOR; SMT (0805); FERRITE-BEAD; 600; TOL=+/-25%; 0.2A
27	MISC1	-	1	68784-0001	MOLEX	68784-0001	CONNECTOR; MALE; USB; USB A PLUG TO MICRO B PLUG CABLE ASSY; STRAIGHT; 4PINS-5PINS
28	R1	-	1	CRCW0402100KFK;RC0402FR-07100KL	VISHAY;YAGEO	100K	RESISTOR; 0402; 100K; 1%; 100PPM; 0.0625W; THICK FILM
29	R2, R3, R7, R9, R21, R23, R24	-	7	CRCW0402100KFK;RC0402FR-07100KL	VISHAY DALE;YAGEO PHICOMP	10K	RESISTOR; 0402; 10K; 1%; 100PPM; 0.0625W; THICK FILM
30	R5	-	1	CP0603F309KC	TE CONNECTIVITY	309K	RES; SMT (0603); 309K; 1%; +/-50PPM/DEGC; 0.063W
31	R6	-	1	CRCW0603549FK	VISHAY DALE	54.9K	RES; SMT (0603); 54.9K; 1%; +/-100PPM/DEGC; 0.1W
32	R8, R10	-	2	CRCW0402100RFR; 9C04021A1000FL; RC0402FR-07100RL	VISHAY DALE;PANASONIC;YAGEO PHYCOMP	100	RESISTOR; 0402; 100 OHM; 1%; 100PPM; 0.063W; THICK FILM
33	R22	-	1	CRCW0603499RFR;RK73H1J4990FT;ERJ-1KEK4990;RC1608F4990	KOA;VISHAY;PANASONIC;SAMSUNG	499	RESISTOR; 0603; 499 OHM; 1%; 100PPM; 0.10W; THICK FILM
34	R25, R28, R30, R31, R34, R36-34 R40	-	10	ERI-2RKF2200	PANASONIC	220	RESISTOR; 0402; 220 OHM; 1%; 100PPM; 0.1W; THICK FILM
35	R26, R27	-	2	CRCW040210R0FK; 9C04021A10R0FL	VISHAY DALE;YAGEO	10	RESISTOR; 0402; 10 OHM; 1%; 100PPM; 0.0625W; THICK FILM
36	R32, R33	-	2	ERI-1GNF2780	PANASONIC	27	RESISTOR; 0201; 27 OHM; 1%; 200PPM; 0.05W; THICK FILM
37	R41, R42	-	2	CRCW04021K00FK; RC0402FR-07100RL;MCR01M2PF1001	VISHAY DALE;YAGEO PHICOMP;ROHM SEMI	1K	RESISTOR; 0402; 1K; 1%; 100PPM; 0.0625W; THICK FILM
38	SU1-SU8	-	8	STC02SYAN	SULLINS ELECTRONICS CORP.	STC02SYAN	TEST POINT; JUMPER; STR; TOTAL LENGTH=0.256IN; BLACK; INSULATION=PBT CONTACT=PHOSPHOR BRONZE; COPPER PLATED TIN OVERALL
39	SW1	-	1	219-10MST	CTS	219-10MST	SWITCH; SPST; SMT; STRAIGHT; 20V; 0.1A; SURFACE MOUNT DIP SWITCH-AUTO PLACABLE; RINSULATION=1000M OHM
40	TP1, TP3-TP5, TP8	-	5	5010	KEYSTONE	N/A	TEST POINT; PIN DIA=0.125IN; TOTAL LENGTH=0.445IN; BOARD HOLE=0.063IN; RED; PHOSPHOR BRONZE WIRE SIL
41	TP6	-	1	571-0500	DELTRON	571-0500	CONNECTOR; FEMALE; THROUGH HOLE; BANANA 4MM SOCKET; RIGHT ANGLE; 2PINS
42	TP7	-	1	571-0100	DELTRON	571-0100	CONNECTOR; FEMALE; THROUGH HOLE; BANANA 4MM SOCKET; RIGHT ANGLE; 2PINS
43	TP9-TP11	-	3	5011	KEYSTONE	N/A	TEST POINT; PIN DIA=0.125IN; TOTAL LENGTH=0.445IN; BOARD HOLE=0.063IN; BLACK; PHOSPHOR BRONZE WIRE SILVER PLATE FINISH;
44	TP13-TP19, TP21-TP23	-	10	5014	KEYSTONE	N/A	TEST POINT; PIN DIA=0.125IN; TOTAL LENGTH=0.445IN; BOARD HOLE=0.063IN; YELLOW; PHOSPHOR BRONZE WIRE SILVER PLATE FINISH;
45	U1	-	1	MAX22513ATH+	MAXIM	MAX22513ATH+	EVKIT PART - IC; TXRX; EMC PROTECTED DUAL DRIVER IO-LINK DEVICE TRANSCEIVER WITH DC/DC; PACKAGE OUTLINE: 21-0184; PACKAGE CODE: T283555+1C; TQFN28-EP IC; CONV; ULTRA-SMALL; HIGH-EFFICIENCY; SYNCHRONOUS STEP-DOWN DC-DC CONVERTER; TQFN10-EP
46	U2	-	1	MAX17501EATB+	MAXIM	MAX17501EATB+	OSCILLATOR; SMT 5X7; 15PF; 50MHZ; N/A; +/-20PPM
47	U3	-	1	ASV-50-0000MHZ-EJT	ABRACON	50MHZ	EVKIT PART; IC; LOW POWER ARM CORTEX-M4 WITH FPU-BASED SOC FOR WEARABLE SENSORS; PACKAGE OUTLINE DRAWING: 21-0139; PACKAGE CODE: T2044-5C; PACKAGE LAND PATTERN: 90-0429
48	U4	-	1	MAX32660	MAXIM	MAX32660	IC; INF; USB TO BASIC UART; DFN12-EP
49	U6	-	1	FT234XD	FUTURE TECHNOLOGY DEVICES INTL LTD	FT234XD	PCB
50	PCB	-	1	MAX22513	MAXIM	PCB	PCB; MAX22513
51	R4	DNP	0	CRCW0402100KFK;RC0402FR-07100KL	VISHAY DALE;YAGEO PHICOMP	10K	RESISTOR; 0402; 10K; 1%; 100PPM; 0.0625W; THICK FILM
52	U5	DNP	0	ARDUINO_UNO_R3	ARDUINO	ARDUINO_UNO_R3	MODULE; ARDUINO_UNO_R3
53	VR1	DNP	0	VCO60326A580DP	AVX	VCO60326A580DP	VARIABLE; TVS; SMT (0603); VB=34.5V; IP=30A
TOTAL			104				

MAX22513 EV Kit Schematic

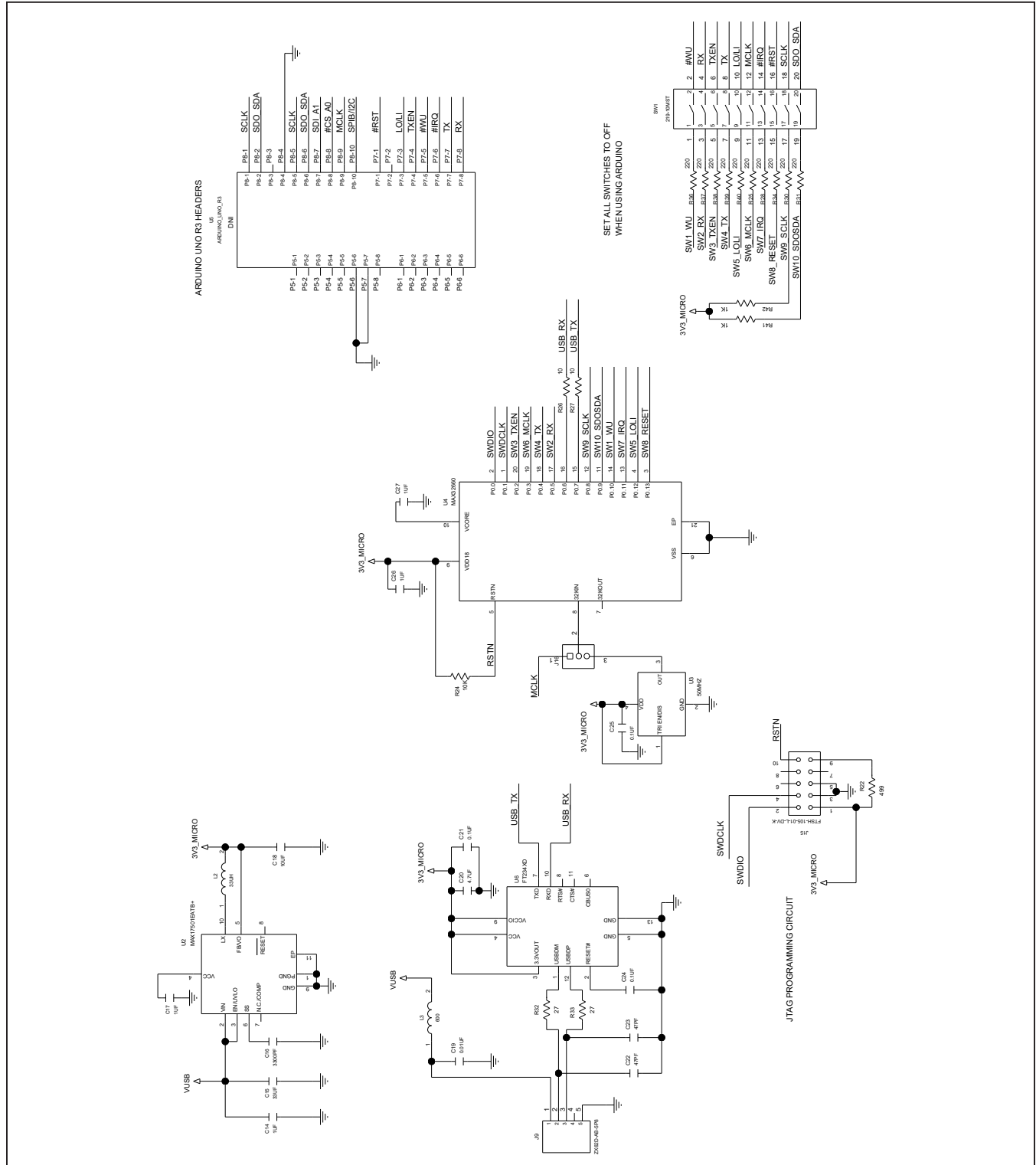

MAX22513 EV Kit Schematic (continued)

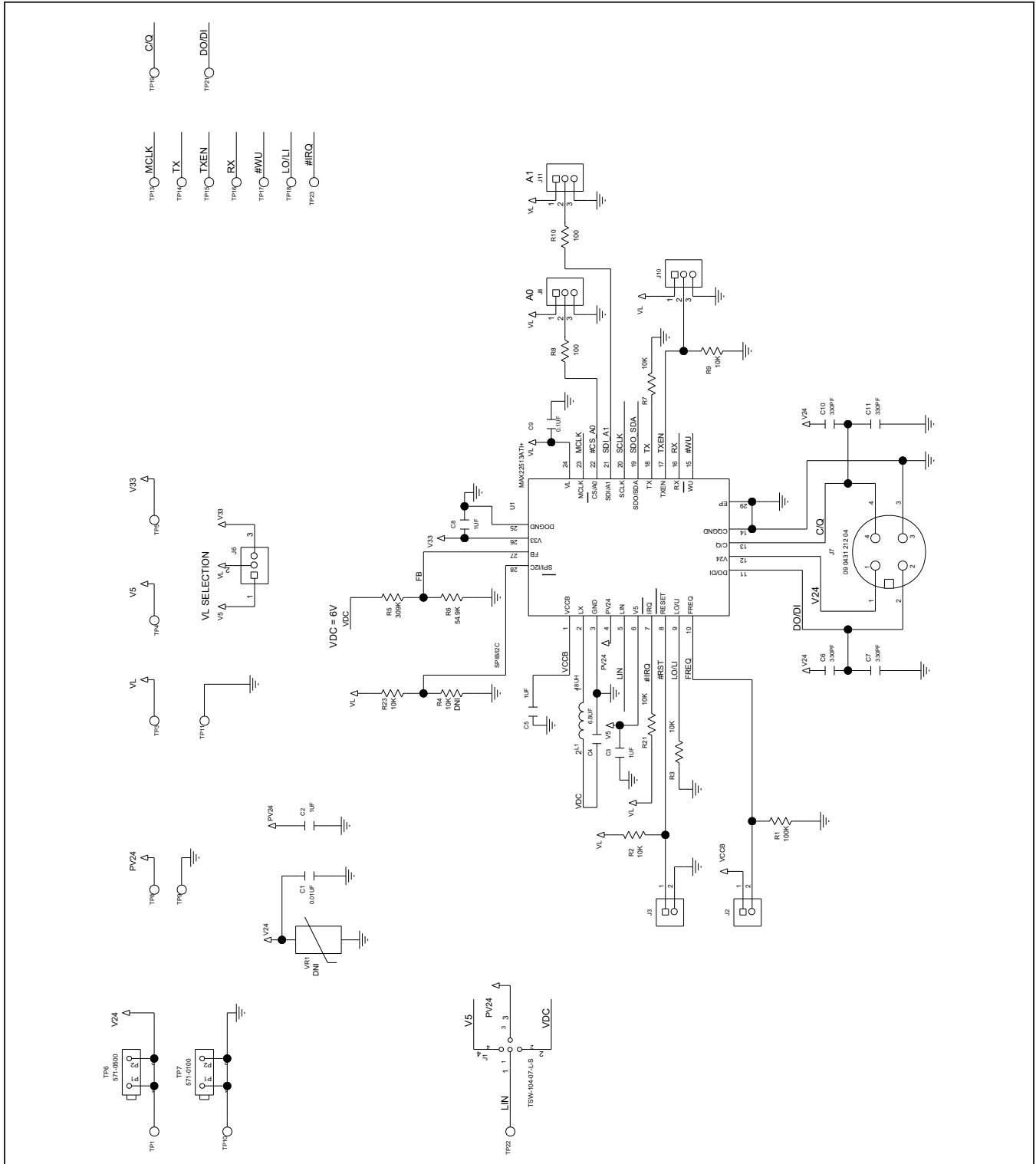

MAX22513 EV Kit PCB Layout Diagrams

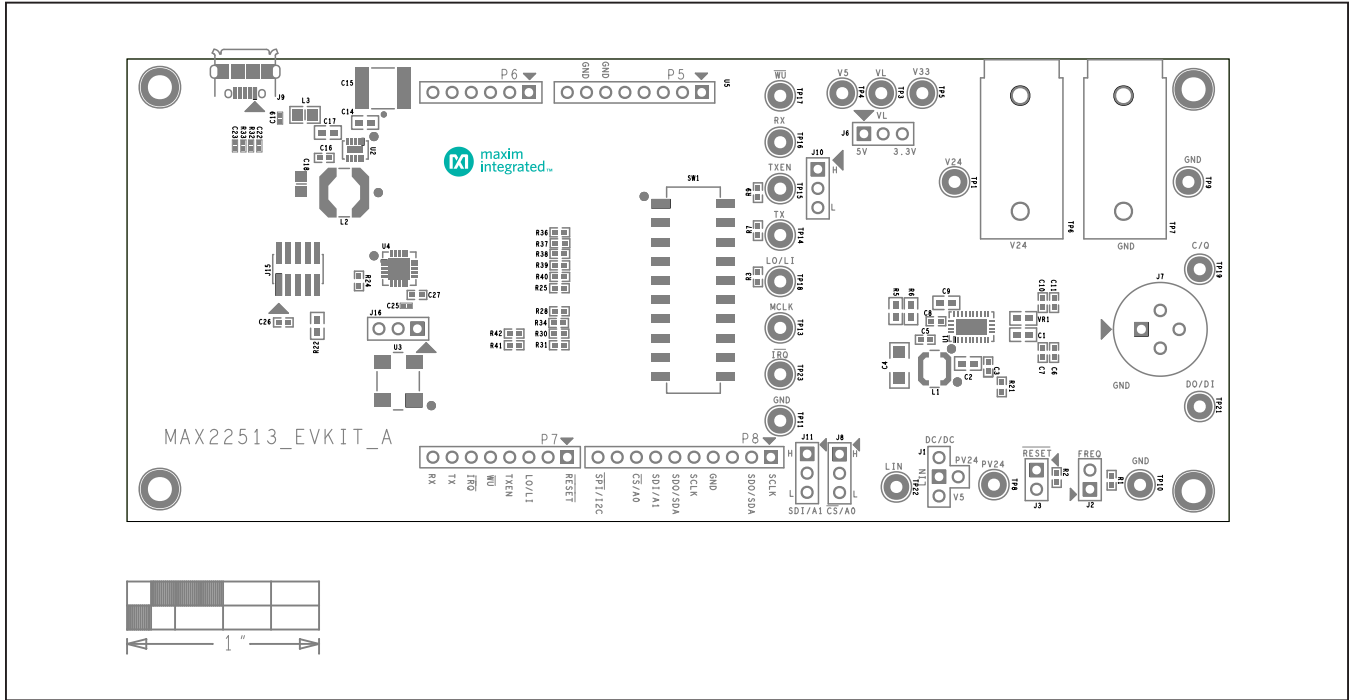

MAX22513 EV Kit PCB Layout—Top Silkscreen

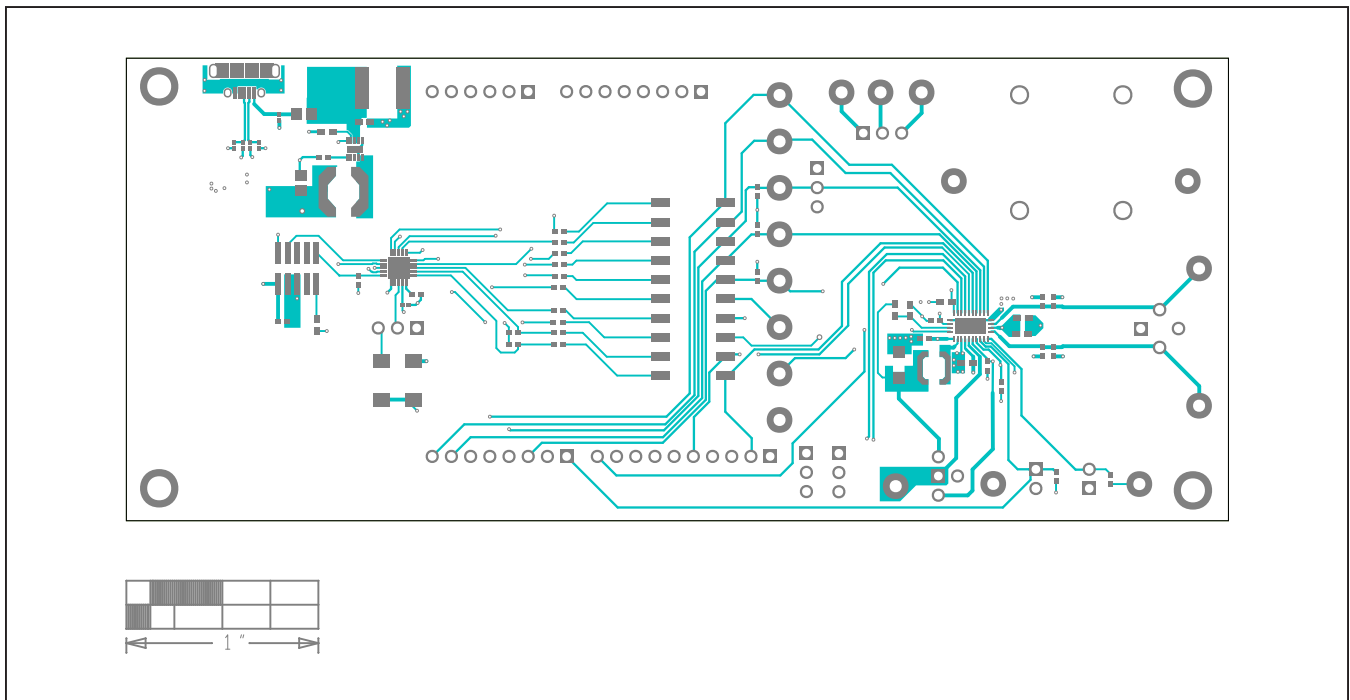

MAX22513 EV Kit PCB Layout—Top Layer



MAX22513 EV Kit PCB Layout Diagrams (continued)

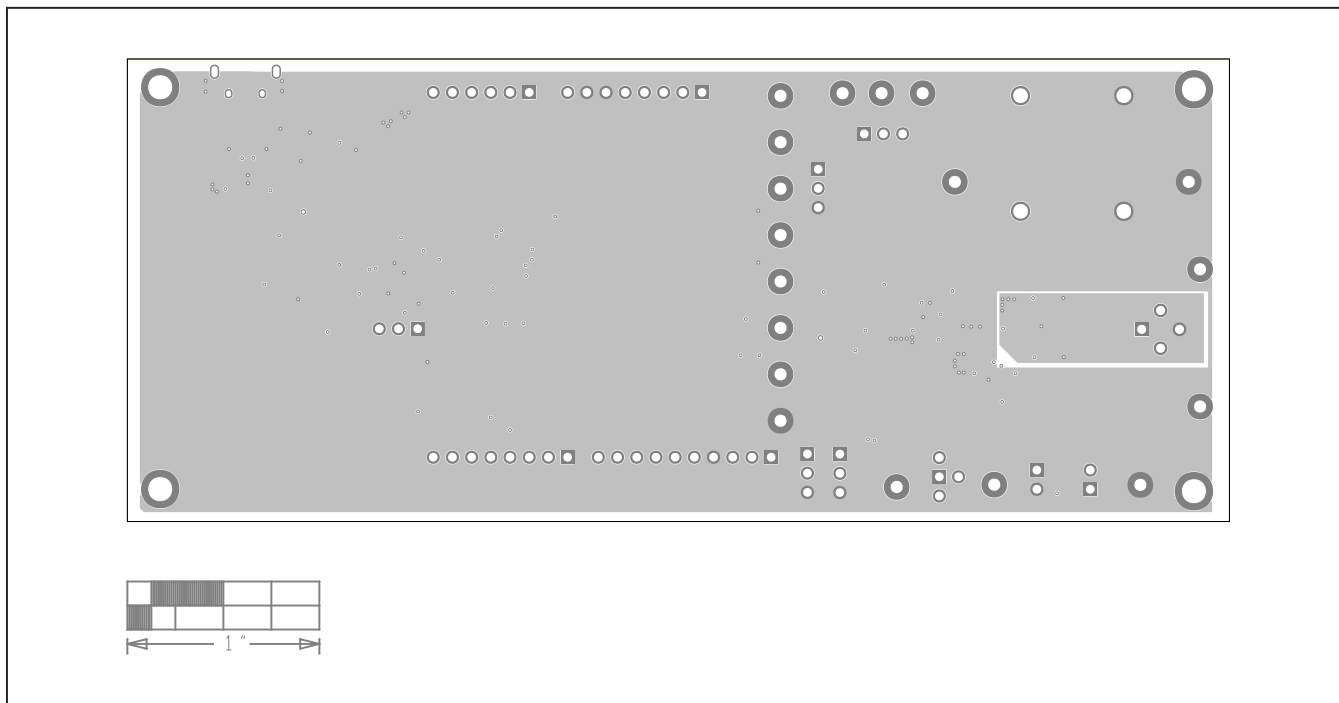

MAX22513 EV Kit—Ground Layer

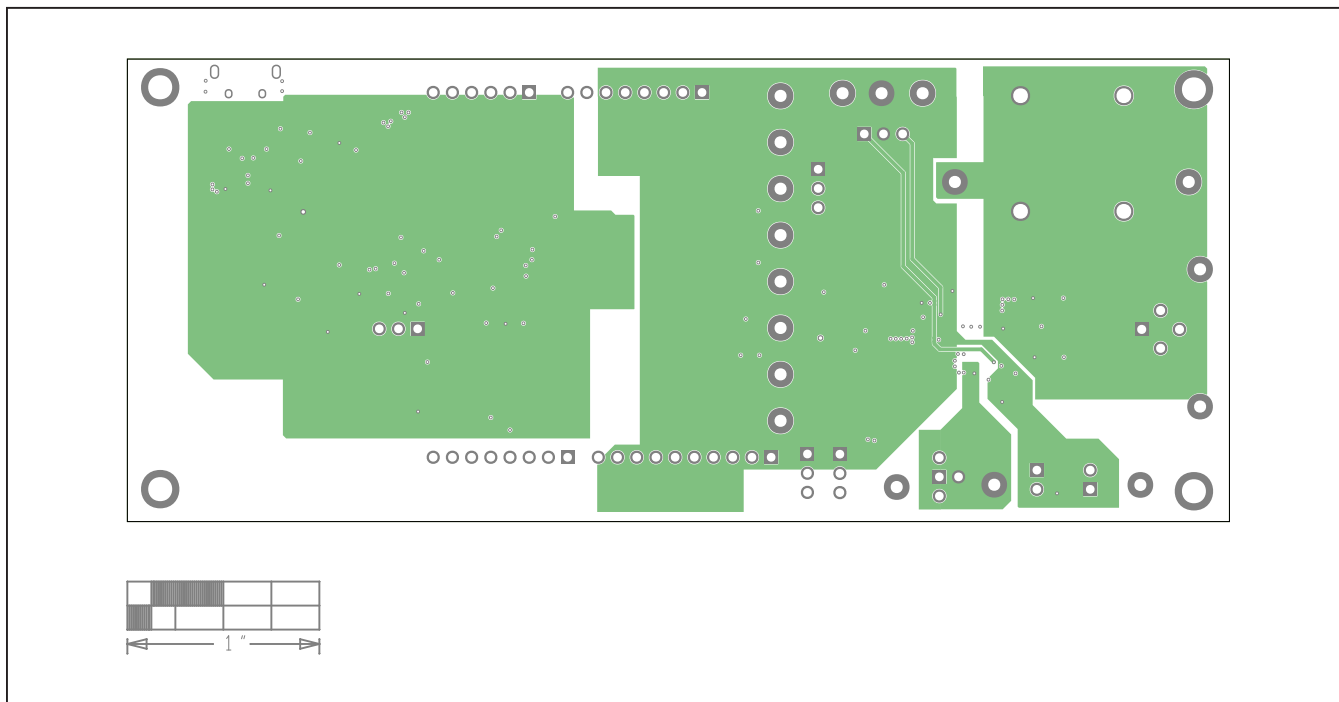

MAX22513 EV Kit—Power Layer

MAX22513 EV Kit PCB Layout Diagrams (continued)

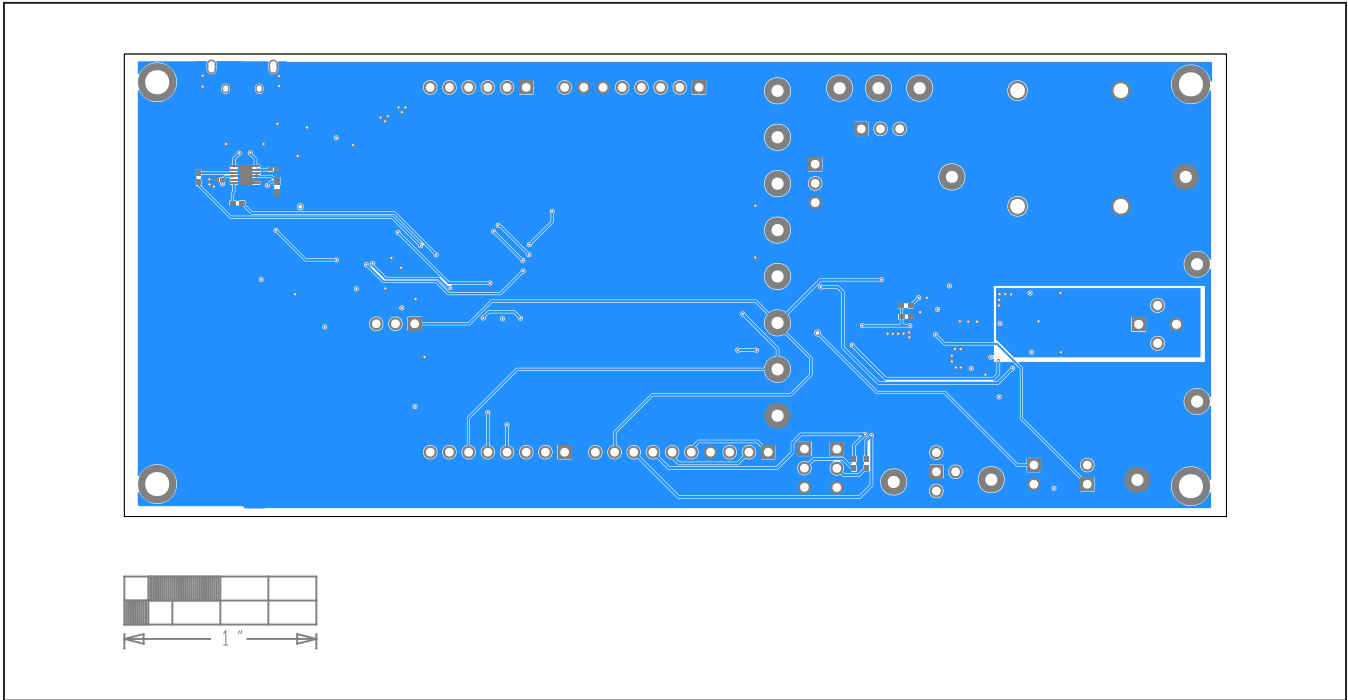

MAX22513 EV Kit—Bottom Layer

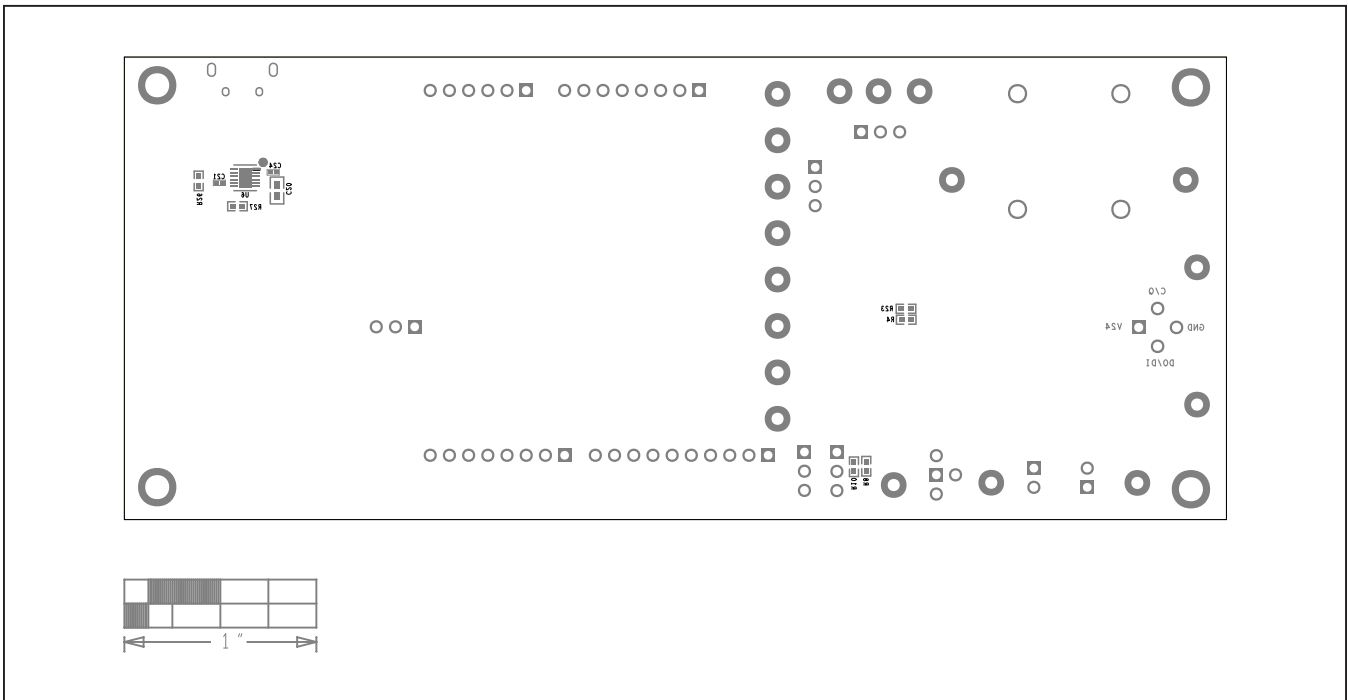

MAX22513 EV Kit—Bottom Silkscreen

## Revision History

REVISION NUMBER	REVISION DATE	DESCRIPTION	PAGES CHANGED
0	2/19	Initial release	—

For pricing, delivery, and ordering information, please visit Maxim Integrated's online storefront at <https://www.maximintegrated.com/en/storefront/storefront.html>.

*Maxim Integrated cannot assume responsibility for use of any circuitry other than circuitry entirely embodied in a Maxim Integrated product. No circuit patent licenses are implied. Maxim Integrated reserves the right to change the circuitry and specifications without notice at any time.*