

CGHV1F025S

25 W, DC - 15 GHz, 40V, GaN HEMT

Cree's CGHV1F025S is an unmatched, gallium nitride (GaN) high electron mobility transistor (HEMT) designed specifically for high efficiency, high gain and wide bandwidth capabilities. The device can be deployed for L, S, C, X and Ku-Band amplifier applications. The datasheet specifications are based on a X-Band (8.9 - 9.6 GHz) amplifier. The CGHV1F025S operates on a 40 volt rail circuit while housed in a 3mm x 4mm, surface mount, dual-flat-no-lead (DFN) package. Under reduced power, the transistor can operate below 40V to as low as 20V V_{DD} , maintaining high gain and efficiency.

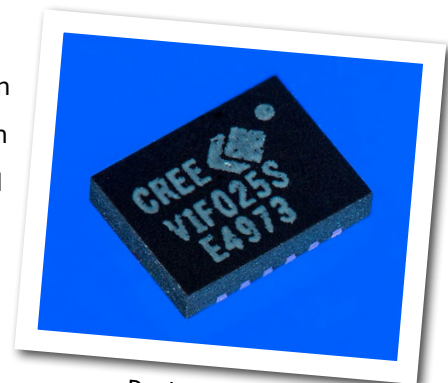

Package Type: 3x4 DFN
PN: CGHV1F025S

Typical Performance 8.9 - 9.6 GHz ($T_c = 25^\circ\text{C}$), 40 V

Parameter	8.9 GHz	9.2 GHz	9.4 GHz	9.6 GHz	Units
Output Power @ $P_{IN} = 37\text{ dBm}$	24	29	27	25	W
Drain Efficiency @ $P_{IN} = 37\text{ dBm}$	43.5	48.5	48	46	%
Gain @ $P_{IN} = 0\text{ dBm}$	10.7	11.6	11.3	11.1	dB

Note:
Measured in the CGHV1F025S-TB1 application circuit. Pulsed 100 μs 10% duty.

Features

- Up to 15 GHz Operation
- 25 W Typical Output Power
- 11 dB Gain at 9.4 GHz
- Application circuit for 8.9 - 9.6 GHz

Absolute Maximum Ratings (not simultaneous) at 25 °C Case Temperature

Parameter	Symbol	Rating	Units	Notes
Drain-Source Voltage	V_{DSS}	100	Volts	25 °C
Gate-to-Source Voltage	V_{GS}	-10, +2	Volts	25 °C
Storage Temperature	T_{STG}	-65, +150	°C	
Operating Junction Temperature	T_J	225	°C	
Maximum Forward Gate Current	I_{GMAX}	4.8	mA	25 °C
Maximum Drain Current ¹	I_{DMAX}	2	A	25 °C
Soldering Temperature ²	T_S	245	°C	
Case Operating Temperature ^{3,4}	T_C	-40, +150	°C	
Thermal Resistance, Junction to Case ⁵	R_{JC}	3.4	°C/W	85 °C

- Note:
- ¹ Current limit for long term, reliable operation
 - ² Refer to the Application Note on soldering at www.cree.com/rf/document-library
 - ³ Simulated at $P_{DISS} = 2.4$ W
 - ⁴ T_C = Case temperature for the device. It refers to the temperature at the ground tab underneath the package. The PCB will add additional thermal resistance.
 - ⁵ Pulsed (100 μ s, 10% Duty). Rth for Cree's reference design using a 10 mil Rogers 5880 PCB with 31 (\varnothing 13 mil) Vias would be 3.6 °C/W. For CW operation, the Rth numbers increase to 5°C/W for just the device, and 7.3 °C/W including the board.

Electrical Characteristics ($T_C = 25^\circ\text{C}$) - 40 V Typical

Characteristics	Symbol	Min.	Typ.	Max.	Units	Conditions
DC Characteristics¹						
Gate Threshold Voltage	$V_{GS(th)}$	-3.8	-3.0	-2.3	V_{DC}	$V_{DS} = 10$ V, $I_D = 4.8$ mA
Gate Quiescent Voltage	$V_{GS(Q)}$	-	-2.7	-	V_{DC}	$V_{DS} = 40$ V, $I_D = 240$ mA
Saturated Drain Current ²	I_{DS}	3.8	-4.3	-	A	$V_{DS} = 6.0$ V, $V_{GS} = 2.0$ V
Drain-Source Breakdown Voltage	$V_{(BR)DSS}$	100	-	-	V_{DC}	$V_{GS} = -8$ V, $I_D = 4.8$ mA
RF Characteristics³ ($T_C = 25^\circ\text{C}$, $F_0 = 6.0$ GHz unless otherwise noted)						
Gain	G	-	16	-	dB	$V_{DD} = 40$ V, $I_{DQ} = 150$ mA, $P_{IN} = 0$ dBm
Output Power ⁴	P_{OUT}	-	29	-	W	$V_{DD} = 40$ V, $I_{DQ} = 150$ mA, $P_{IN} = 34$ dBm
Drain Efficiency ⁴	η	-	55	-	%	$V_{DD} = 40$ V, $I_{DQ} = 150$ mA, $P_{IN} = 34$ dBm
Output Mismatch Stress ⁴	VSWR	-	10 : 1	-	Ψ	No damage at all phase angles, $V_{DD} = 40$ V, $I_{DQ} = 150$ mA, $P_{OUT} = 29$ W
Dynamic Characteristics						
Input Capacitance ⁵	C_{GS}	-	5.9	-	pF	$V_{DS} = 40$ V, $V_{gs} = -8$ V, $f = 1$ MHz
Output Capacitance ⁵	C_{DS}	-	2	-	pF	$V_{DS} = 40$ V, $V_{gs} = -8$ V, $f = 1$ MHz
Feedback Capacitance	C_{GD}	-	0.21	-	pF	$V_{DS} = 40$ V, $V_{gs} = -8$ V, $f = 1$ MHz

- Notes:
- ¹ Measured on wafer prior to packaging
 - ² Scaled from PCM data
 - ³ Measured in CGHV1F025S-TB
 - ⁴ Pulsed 100 μ s, 10% duty cycle
 - ⁵ Includes package

Electrical Characteristics When Tested in CGHV1F025S-TB1

Characteristics	Symbol	Min.	Typ.	Max.	Units	Conditions
RF Characteristics¹ ($T_c = 25^\circ\text{C}$, $F_o = 8.9 - 9.6\text{ GHz}$ unless otherwise noted)						
Gain	G	-	11.6	-	dB	$V_{DD} = 40\text{ V}$, $I_{DQ} = 150\text{ mA}$, $P_{IN} = 0\text{ dBm}$
Output Power ²	P_{OUT}	-	29	-	W	$V_{DD} = 40\text{ V}$, $I_{DQ} = 150\text{ mA}$, $P_{IN} = 37\text{ dBm}$
Drain Efficiency ²	η	-	48.5	-	%	$V_{DD} = 40\text{ V}$, $I_{DQ} = 150\text{ mA}$, $P_{IN} = 37\text{ dBm}$
Output Mismatch Stress ²	VSWR	-	10 : 1	-	Ψ	$V_{DS} = 40\text{ V}$, $V_{gs} = -8\text{ V}$, $P_{OUT} = 25\text{ W}$

Notes:

¹ Measured in CGHV1F025S-TB1 Application Circuit

² Pulsed 100 μs , 10% duty cycle

Typical Performance - CGHV1F025S-TB1

Figure 1. - Typical Small Signal Response of CGHV1F025S-TB1 Application Circuit
 $V_{DD} = 40\text{ V}$, $I_{DQ} = 150\text{ mA}$

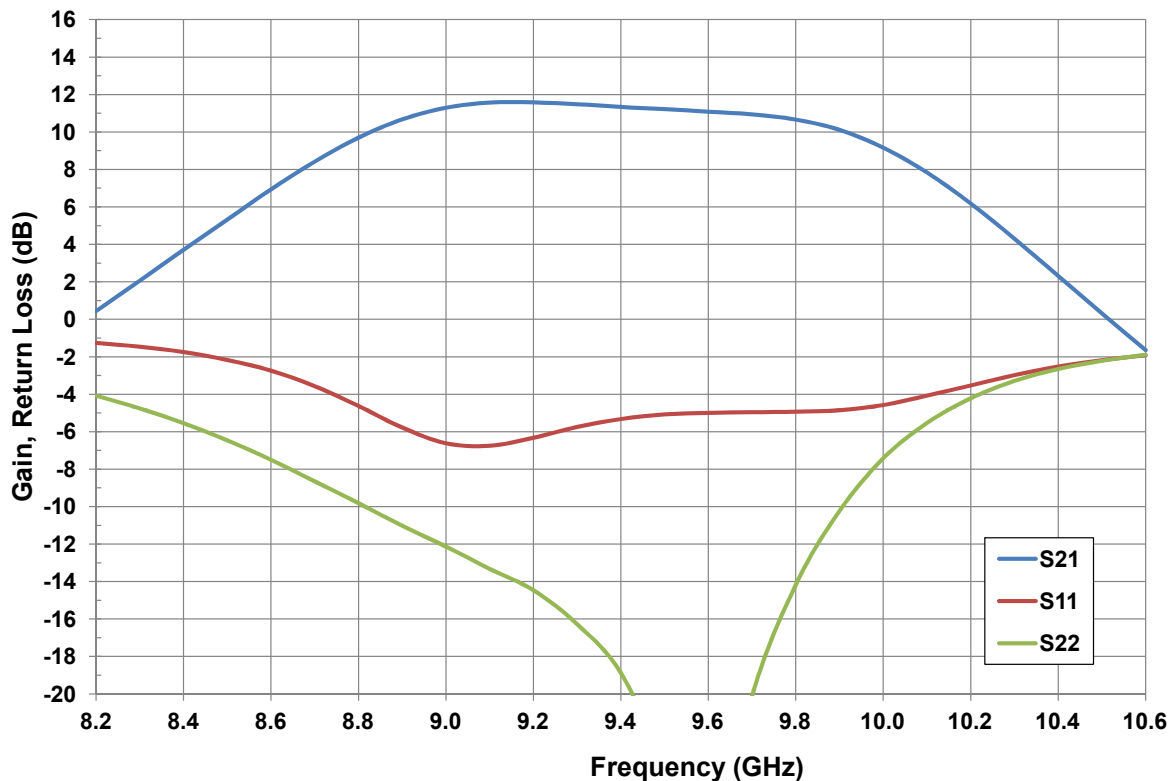

Typical Performance in Application Circuit CGHV1F025S-TB1

Figure 2. - Typical Large Signal Response
 $V_{DD} = 40\text{ V}$, $I_{DQ} = 150\text{ mA}$, $P_{IN} = 37\text{ dBm}$
 $T_{case} = 25^\circ\text{C}$, Pulse Width = $100\ \mu\text{s}$, Duty Cycle = 10 %

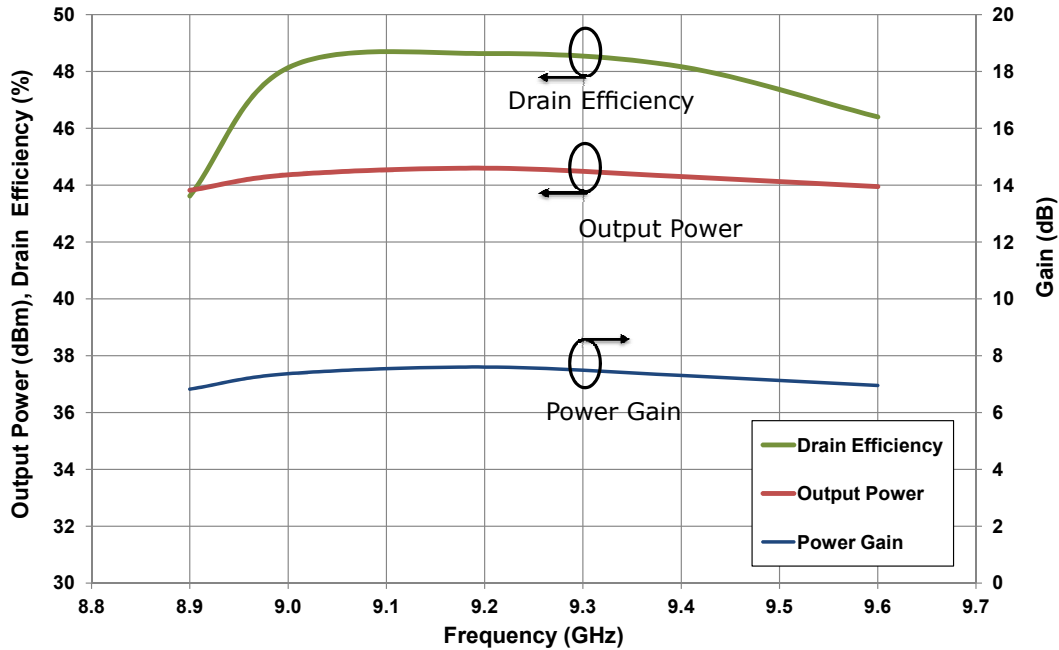
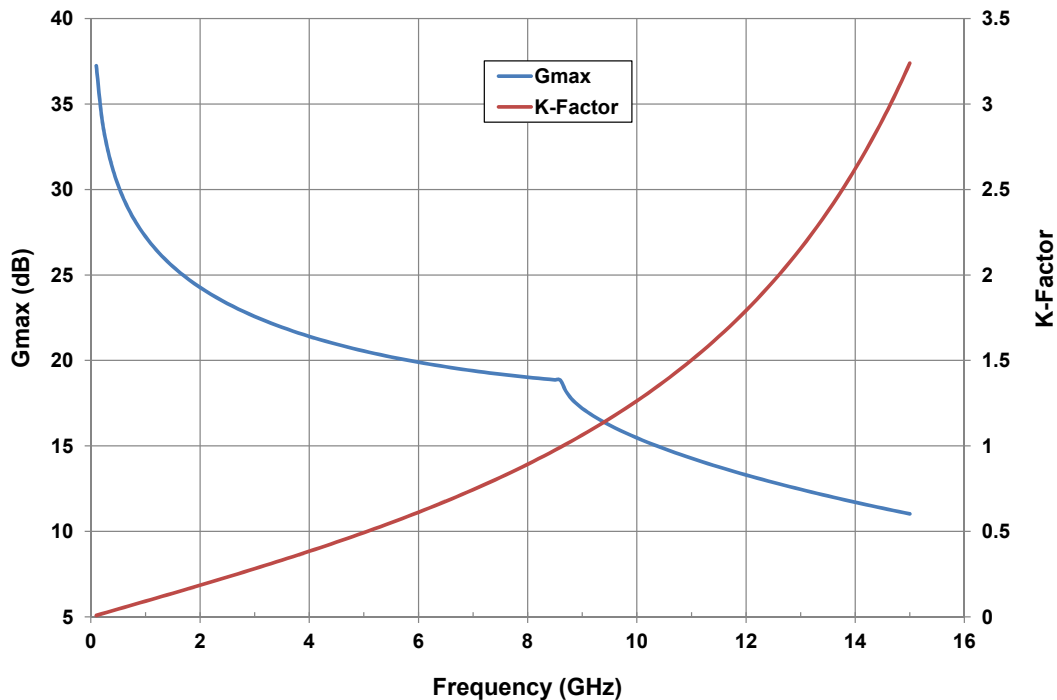

Figure 3. - G_{MAX} and K-Factor vs Frequency
 $V_{DD} = 40\text{ V}$, $I_{DQ} = 150\text{ mA}$, $T_{case} = 25^\circ\text{C}$



CGHV1F025S-TB1 Application Circuit Bill of Materials

Designator	Description	Qty
R1	RES, 100, OHM, +/-1%, 1/16 W, 0603	1
R2	RES, 10, OHM, +/-1%, 1/16 W, 0603	1
C1, C2	CAP, 1pF, ±0.1 pF, 0603, ATC	2
C3, C4	CAP, 1.8pF, ±0.1 pF, 0603, ATC	2
C9, C10	CAP, 0.6pF, ±0.1 pF, 0603, ATC	2
C5, C11	CAP, 10 pF, ±5%, 0603, ATC	1
C6, C12	CAP, 470 pF, 5%, 100 V, 0603, X	2
C7, C13	CAP, 33000 pF, 0805, 100V, X7R	2
C14	CAP, 1.0 UF, 100V, 10%, X7R, 1210	1
C8	CAP, 10 UF, 16V TANTALUM	1
C15	CAP, 33UF, 20%, G CASE	1
J1, J2	CONN, SMA, PANEL MOUNT JACK, FLANGE	2
J3	HEADER RT>PLZ .1CEN LK 5POS	1
Q1	QFN TRANSISTOR CGHV1F025S	1
W1	CABLE, 18 AWG, 4.2	1
	Rogers 5880 PCB 10 mils	1

CGHV1F025S-TB1 Application Circuit

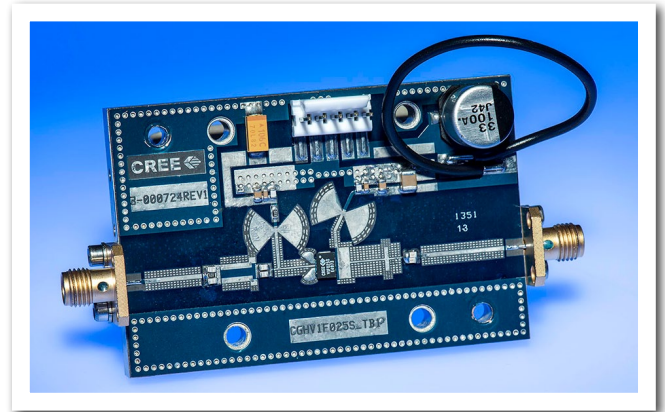

Electrostatic Discharge (ESD) Classifications

Parameter	Symbol	Class	Test Methodology
Human Body Model	HBM	1A (> 250 V)	JEDEC JESD22 A114-D
Charge Device Model	CDM	2 (125 V to 250 V)	JEDEC JESD22 C101-C

CGHV1F025S-TB1 Application Circuit Schematic

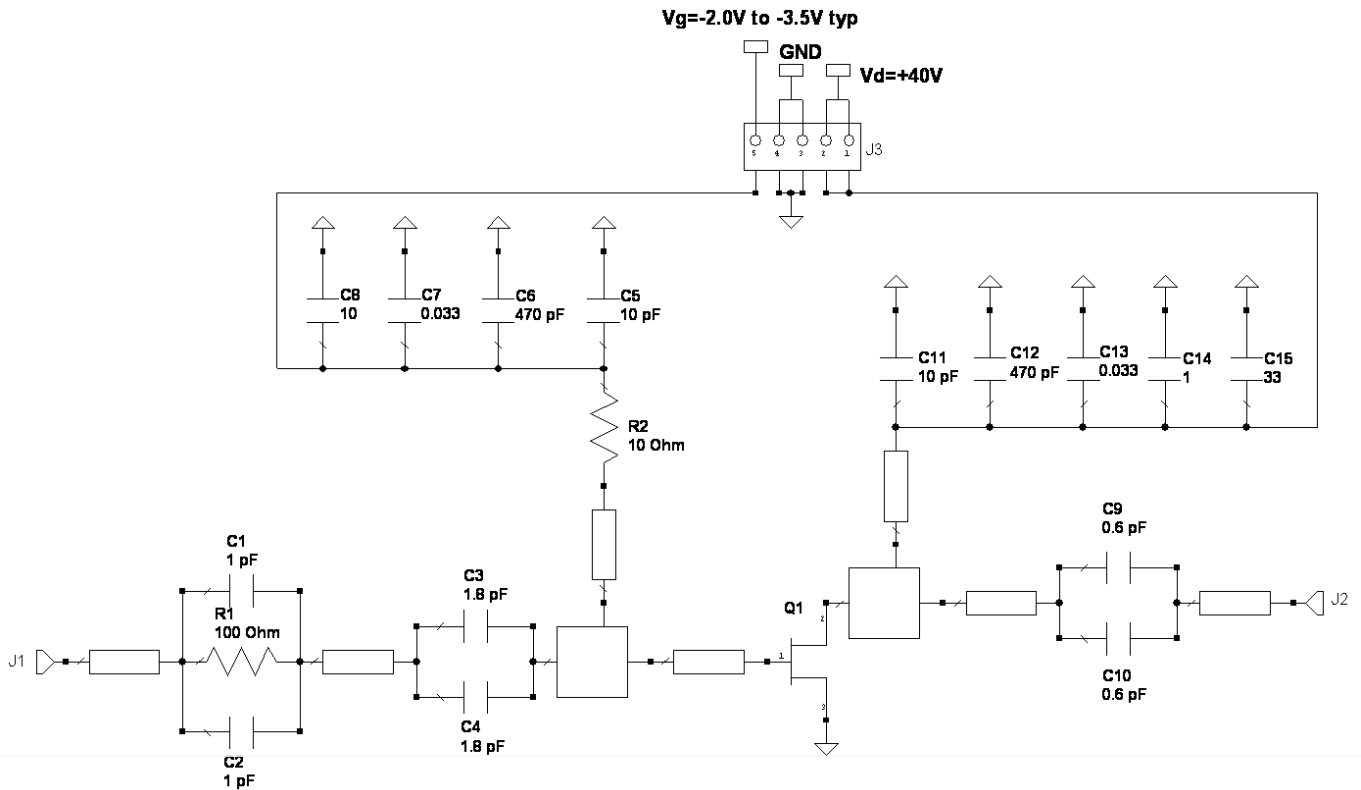

CGHV1F025S-TB1 Application Circuit Outline

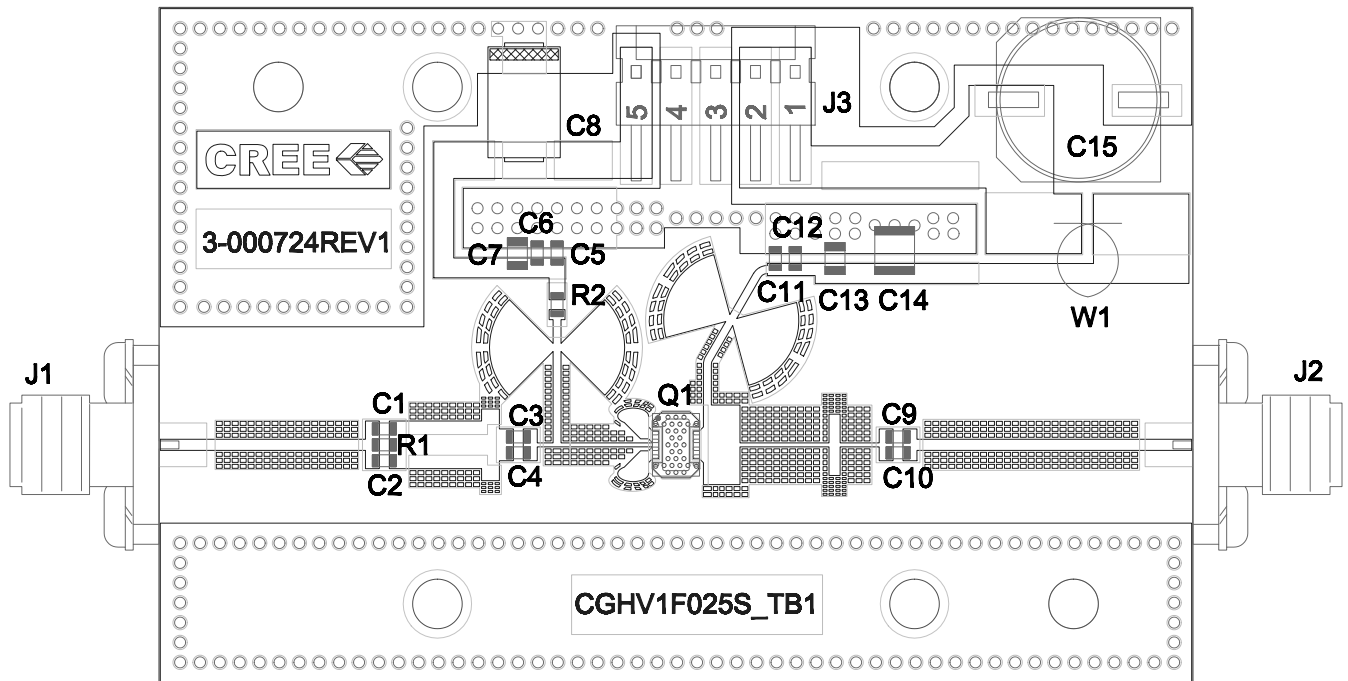

Product Dimensions CGHV1F025S (Package 3 x 4 DFN)

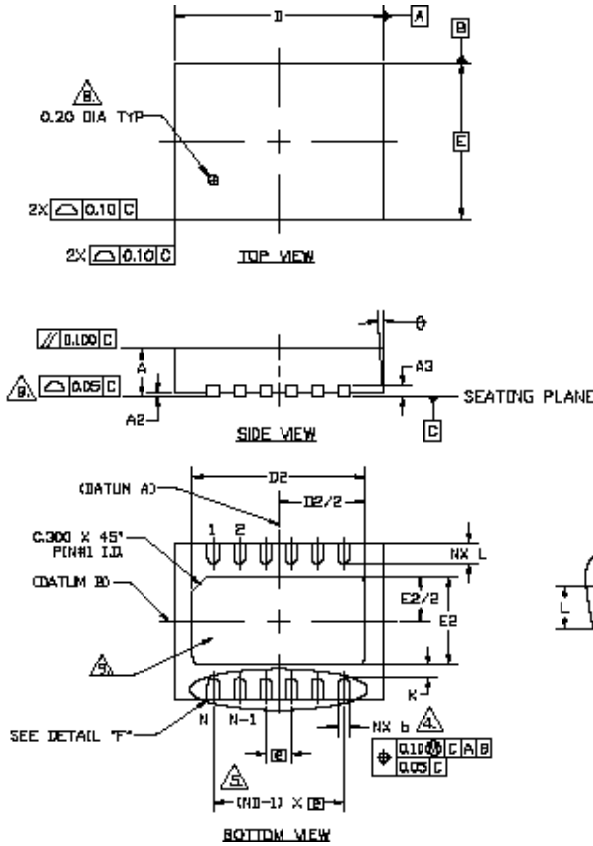

NOTES :

1. DIMENSIONING AND TOLERANCING CONFORM TO ASME Y14.5M – 1994.
2. ALL DIMENSIONS ARE IN MILLIMETERS, θ IS IN DEGREES.
3. N IS THE TOTAL NUMBER OF TERMINALS.
4. DIMENSION b APPLIES TO METALIZED TERMINAL AND IS MEASURED BETWEEN .15 AND .30mm FROM TERMINAL TIP. IF THE TERMINAL HAS THE OPTIONAL RADIUS ON THE OTHER END OF THE TERMINAL, THE DIMENSION b SHOULD NOT BE MEASURED IN THAT RADIUS AREA.
5. ND REFERS TO THE NUMBER OF TERMINALS ON D SIDE
6. MAXIMUM PACKAGE WARPAGE IS .05 mm.
7. MAXIMUM ALLOWABLE BURRS IS .076 mm IN ALL DIRECTIONS.
8. PIN #1 ID ON TOP WILL BE LASER MARKED.
9. UNILATERAL COPLANARITY ZONE APPLIES TO THE EXPOSED HEAT SINK SLUG AS WELL AS THE TERMINALS.

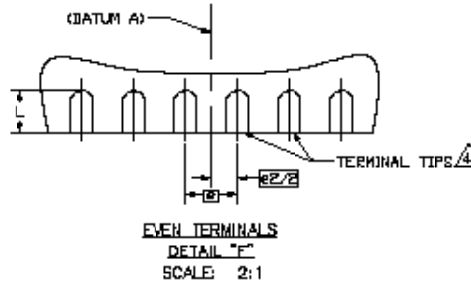

COMMON DIMENSIONS				
	MIN	NOM.	MAX.	N_{RF}
A	0.80	0.85	0.90	
A1	0.00	0.02	0.05	
A3	0.20J REF.			
B		1.2	2	
D	4.00 BSC			
E	3.00 BSC			
F	0.50 BSC			
N	8			3
ND	12			4
L	0.35	0.40	0.45	
b	0.17	0.22	0.27	
D2	3.20	3.30	3.40	
E2	1.60	1.7	1.80	
K	0.20			

Pin	Input/Output
1	GND
2	RF IN
3	RF IN
4	RF IN
5	RF IN
6	GND
7	GND
8	RF OUT
9	RF OUT
10	RF OUT
11	RF OUT
12	GND

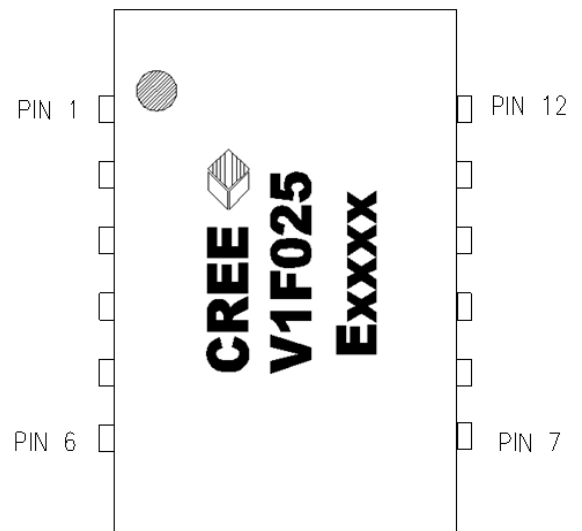

Part Number System

CGHV1F025S

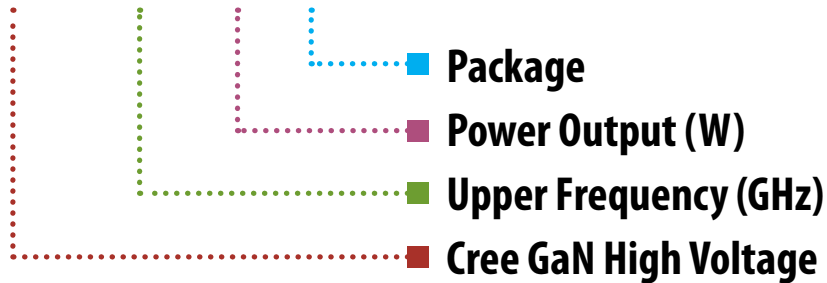

Parameter	Value	Units
Upper Frequency ¹	15.0	GHz
Power Output	25	W
Package	Surface Mount	-

Table 1.

Note¹: Alpha characters used in frequency code indicate a value greater than 9.9 GHz. See Table 2 for value.

Character Code	Code Value
A	0
B	1
C	2
D	3
E	4
F	5
G	6
H	7
J	8
K	9
Examples:	1A = 10.0 GHz 2H = 27.0 GHz

Table 2.



Disclaimer

Specifications are subject to change without notice. Cree, Inc. believes the information contained within this data sheet to be accurate and reliable. However, no responsibility is assumed by Cree for any infringement of patents or other rights of third parties which may result from its use. No license is granted by implication or otherwise under any patent or patent rights of Cree. Cree makes no warranty, representation or guarantee regarding the suitability of its products for any particular purpose. "Typical" parameters are the average values expected by Cree in large quantities and are provided for information purposes only. These values can and do vary in different applications and actual performance can vary over time. All operating parameters should be validated by customer's technical experts for each application. Cree products are not designed, intended or authorized for use as components in applications intended for surgical implant into the body or to support or sustain life, in applications in which the failure of the Cree product could result in personal injury or death or in applications for planning, construction, maintenance or direct operation of a nuclear facility.

For more information, please contact:

Cree, Inc.
4600 Silicon Drive
Durham, North Carolina, USA 27703
www.cree.com/rf

Sarah Miller
Marketing
Cree, RF Components
1.919.407.5302

Ryan Baker
Marketing
Cree, RF Components
1.919.407.7816

Tom Dekker
Sales Director
Cree, RF Components
1.919.313.5639